



United Pacific

1966-1977

FORD BRONCO





The 1966 Ford Bronco was the beginning of an American Icon and to this day is still one of the most popular vehicles ever produced. Whether you are a classic car enthusiast, a hardcore off-roader or a steady daily driver, United Pacific has the replacement and restoration parts you need to make your Ford Bronco the build of your dreams.

As leaders in the industry, it is our mission to ensure the best fitment and function when it comes to your custom build. We understand the rigors and stresses that our products are subjected to on the road, so we partner with top manufacturing facilities that conform to our strict requirements and must perform quality assurance tests. It is our duty to provide our customers with products of superior quality and reliability.



QUALITY

With over 30 years of experience in the automotive aftermarket industry, United Pacific Industries understands the rigors and stresses that our products are subjected to on the road. It is our mission to provide our customers with products of superior quality and reliability. In achieving this goal, United Pacific only partners with manufacturing facilities that conforms to our quality control requirements and standards. Our manufacturing partners meet or exceed ISO-9001 requirements. In addition, United Pacific's manufacturing partners must be equipped on site to perform the following quality assurance tests and maintain a track record of consistent quality and low product failure rate.

- Aging Test
- Air Tight Test
- Dust Test
- Flux Test
- Photometric Test
- Pull Force Test
- Rain Test
- Salt Spray Test
- Shock Test
- Temperature Test
- Humidity Test
- Vibration Test

Furthermore, our internal quality control structure allows us to function as the final quality control station prior to shipping. With the assistance of 3D computer technology, United Pacific can adhere to strict quality control standards during prototype creation and the production process. Our engineers and technicians perform a battery of tests to ensure that our products meet the demands of today's drivers and our goal to be first in quality.

INNOVATION

Known as the leader in innovation, United Pacific is dedicated to be the first to bring new and exciting products to the market. United Pacific's global expertise allows us to search the globe for new ideas and concepts. Not only do we search the globe for new products, United Pacific invest a significant amount of resources into our own research and development efforts. With the assistance of advance 3D scanning technology, our engineers and designers can acquire accurate and precise data in seconds. The 3D data allows United Pacific to verify designs, perform quality assurance tests, and reverse engineer with unprecedented speed and accuracy. Digital inspection contributes to the early detection of shape problems, provides rapid feedback on design, and eliminates unnecessary work in downstream processes. Our rapid prototyping facility permits us to have a concept-to-shelf time of less than 5 months. In addition, United Pacific's 3D printing capabilities permit our designers to have physical models of their design concepts in hours. The physical models allow our designers and marketing staff to evaluate and test the viability of different design ideas. Our rapid prototyping facility allow United Pacific to compress design cycles, improve manufacturing planning, shorten concept-to-shelf time, most importantly, generate new and innovative products.

DESIGN

Located near some of the nation's most progressive automotive design centers, United Pacific established the UP Design Studio in 2002 to consolidate our position as the design leader in the automotive industry. UP Design Studio utilizes the latest generation of computer aided design (CAD) and studio/graphic software. The design studio is equipped with the newest computers and rapid prototyping systems. In addition, UP Design Studio is staffed by graduates from the nation's most prestigious design colleges. Unlike our competitors, United Pacific's design and manufacturing capabilities mean that we carry more new and original items than our competitors. The establishment of the design studio will enable us to generate even more new products with significant shorter concept-to-shelf time. The reduction in development cost mean that we can develop products utilizing design based development processes. Design based product development allows United Pacific to create new product concepts based on designs incorporating driver demands and needs instead of economic considerations. United Pacific's emphasis on design distinguishes and positions us ahead of our competitors.



WARRANTY

With LED (Light Emitting Diodes) rated at 100,000 hours of operation and solid-state construction, United Pacific's LED lights are extremely reliable and durable. Purchase with confidence, United Pacific offers a complete line of LED lighting products with extended or limited lifetime warranties. Please see the warranty policy page for more details.



HARD AT WORK FOR THE ENVIRONMENT



United Pacific
132,000 sq ft
Distribution Center
Long Beach, CA

100% reduction in potable water used for landscaping
40% reduction in total energy use due to high-efficiency mechanical and lighting systems
82% of construction waste was diverted from landfills

LEED ACCOMPLISHMENTS

Sustainable Sites

- On-site bicycle storage, showers and changing areas for company employees.
- Preferred parking for low-emitting, fuel-efficient and carpool vehicles.
- Stormwater is infiltrated on-site and treated to remove contaminants to reduce environmental impact on local waterways.

Water Efficiency

- In addition to using reclaimed water, drought-tolerant plants and a high-efficiency irrigation system were installed to reduce the use of potable water for irrigation by 100%.

Energy and Atmosphere

- Efficient HVAC equipment and a lighting system with daylight controls reduces energy consumption by over 30%.
- Enhanced commission verifies that the building's energy and water-related systems are performing as intended by the initial design.

Indoor Environmental Quality

- Building ventilation systems was designed to provide enhanced levels of fresh outside air to building occupants.
- Interior finishes (plants, sealants, adhesives, coatings, carpet systems and composite wood) were selected with low levels of volatile organic compounds (VOCs) to reduce indoor air contamination.



United Pacific

FORD BRONCO

We partnered with Maxlider Brothers Custom for the 2018 SEMA Show, collaborating with them to build a custom '74 Ford Bronco using our steel replacement panels and LED lighting.



2018
SEMA SHOW
Battle of the Builders
Top 10 Truck Build



2019
DETROIT AUTORAMA
Radical Mini 4x4
1st Place



2019
BRONCO SUPER CELEBRATION
Professional Builders
1st Place & Best of Show





United Pacific

FORD BRONCO

BUILDER	Maxlider Brothers Customs
BODY	Sheet metal by United Pacific Industries with hand built tub by Maxlider Brothers Customs
ENGINE	Ford Performance Coyote 5.0L Mustang engine
TRANSMISSION	Heavy Duty 4R70W by Bowler Transmission and CompuShift electronic controller
TRANSFER CASE	Atlas 2 from Advance Adapters
CHASSIS	Custom chassis by Maxlider Brothers Customs
SUSPENSION	Custom 4-link front, 3-link rear and long-arms by Black Beard Broncos with Fox coil-over shocks
AXLES & DIFFERENTIALS	Currie axle housings, Yukon Gear and Axle differentials & axles, Randy's Driveshafts
BRAKES	Wilwood 4-wheel disc brakes
TIRES	33x12.5x15-inch BFGoodrich KM2's
INTERIOR	Custom leather seats and panels by Twin City Upholstery
CAGE	4-point interior cage by Black Beard Broncos
COYOTE KIT	(Brackets, cooling system, engine mounts, A/C, exhaust): BC Broncos
GAUGES	Classic Instruments cluster
LIGHTS AND LENSES	United Pacific Industries
RUNNING BOARDS	AMP Research powered running boards
STEERING GEARBOX	Steerco/AGR
STEERING COLUMN	Flaming River
FUEL TANK	Black Beard Broncos
CONSOLE	ICON 4x4
ACCESSORIES	Wire harness, body lift and bushings, glass, door handles/components, mirrors, switches, seat belts, hardware kit, fender flares: Wildhorses4x4
SEALS, BUMPERS	Bronco Graveyard



United Pacific
FORD BRONCO



HOODS



1966-77 FORD BRONCO

HOOD WITH WASHER HOLES & VENTS

- Die stamped with high quality 18 gauge sheet metal
- Uses the early 66-69 style hood rod prop location
- Pre-drilled fold down windshield u-bolt mounting holes with reinforced center brace
- Also has air box vent openings and washer mounting holes
- Black EDP coated finish
- *Oversize freight policy*

110460

HOODS



1966-77 FORD BRONCO

HOOD WITH VENTS

- Die stamped with high quality 18 gauge sheet metal
- Uses the early 66-69 style hood rod prop location
- Has air box vent openings and washer mounting holes
- Black EDP coated finish
- *Oversize freight policy*

110461



1966-77 FORD BRONCO

HOOD WITH WASHER HOLES & VENTS

- Die stamped with high quality 18 gauge sheet metal
- Uses the 70-77 style hood rod prop location
- Has air box vent openings and washer mounting holes
- Black EDP coated finish
- *Oversize freight policy*

110462

GRILLES



1966-68 FORD BRONCO

GRILLE WITHOUT LOGO - BLACK EDP

- Die stamped with high quality 16 gauge sheet metal
- Feature all of the original contour detail and mounting brackets for the early small round signal lights
- Smooth center bar design without Ford letters to keep that clean front end look
- Black EDP coated finish
- Headlight adjusters included
- *Oversize freight policy*

110513



1966-77 FORD BRONCO

GRILLE WITHOUT LOGO - CHROME

- Die stamped with high quality 17 gauge sheet metal
- Feature all of the original contour detail and mounting brackets for the larger turn signal lights
- Smooth center bar design without Ford letters to keep that clean front end look
- Beautiful show ready chrome plated finish
- Headlight adjusters included
- *Oversize freight policy*

110516



1969-77 FORD BRONCO

GRILLE WITHOUT LOGO - BLACK EDP

- Die stamped with high quality 17 gauge sheet metal
- Feature all of the original contour detail and mounting brackets for the larger round signal lights
- Smooth design to keep that clean front end look
- Black EDP coated finish
- Headlight adjusters included
- *Oversize freight policy*

110515



TRIM/EMBLEMS

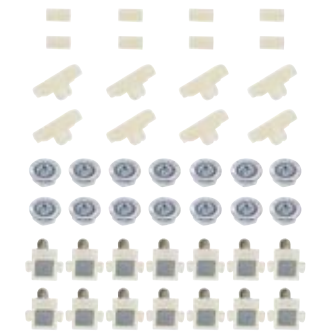
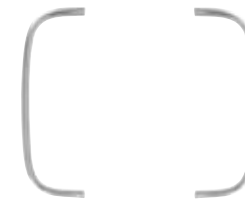

1966-77 FORD BRONCO

POLISHED ALUMINUM GRILLE TRIM MOLDING KIT

- Beautiful polished high quality aluminum extrusion with clear anodizing
- Overlapped connecting ends just like original
- Original connecting ends just like original

110594



1966-77 FORD BRONCO

FORD GRILLE LETTER SET

- High quality chrome plated
- Comes with speed nuts for easy installation

110482



1966-77 FORD BRONCO

CHROME BRONCO EMBLEM

- Beautifully chrome plated with triple chrome plating process
- Highly detailed bucking bronco
- Approximately 3 1/2" wide x 2 1/8" tall
- Double sided tape included

50130



1966-77 FORD BRONCO

BRONCO GRILLE LETTER SET

- High quality die-cast & chrome plated with gloss red inlay
- 12 speed nuts and drill template included for easy installation
- Unique design made for aftermarket smooth style grilles without Ford lettering
- Official licensed product by Ford Motor Company

110499



BUMPERS/FENDERS



1966-77 FORD BRONCO FRONT/REAR BUMPER

- Made with heavy 1/8" thick sheet metal
 - Fits front or rear
 - Features all original square shaped mounting holes
 - Polished stainless steel bumper bolt set sold separately
 - *Oversize freight policy*
- 110465 | Chrome**
110466 | Black
110536 | Bumper bolt set



1966-77 FORD BRONCO FRONT FENDER

- Die stamped 19 gauge sheet metal
 - Features all original fender curvature and mounting pattern, without sidemarker cutout and emblem stud holes
 - Black EDP coated finished
 - Sold individually, please specify left or right side
 - *Oversize freight policy*
- 110463 | Driver LH**
110464 | Passenger RH

FENDER HARDWARE



1966-77 FORD BRONCO FRONT FENDER APRON

- Quality 20 gauge stamped steel
 - Features all original contour and mounting patterns for front fender installation
 - Coated with weldable primer
 - Sold individually, please specify left or right side
- 110365 | Driver LH**
110364 | Passenger RH



1966-77 FORD BRONCO FRONT FENDER LOWER BRACE WITH J-NUTS

- High quality die-stamped 18 gauge sheet metal
 - Features strengthening gusset just like original
 - Includes 5/16-18 J-nuts for easy installation to fender and fender apron
 - Zinc plated finish for corrosion resistance
- 110596**



1966-77 FORD BRONCO 18FT FENDER FLARE ROLL

- 18ft roll of fender flare welting
 - Welting mounts between the flare and the body to provide a finished edge
 - 1/16" bead, 1 1/4" wide, 1/16" thick, heat & UV resistant black PVC material
 - Each 18' roll is enough for 2 flares, 2 sets required for full bronco
- 110539**



1966-77 FORD BRONCO FRONT FENDER SUPPORT BRACKET

- Heavy duty steel rod with flattened ends
 - Same exact length as original for easy installation
 - 5/16-18 threaded mounting holes
 - Zinc plated finish for corrosion resistance
- 110592 | LH**
110593 | RH



1966-77 FORD BRONCO QUARTER PANEL SUPPORT BRACKETS

- Heavy duty steel rod with flattened ends
 - Same exact length as original for easy installation
 - 1/4-20 threaded mounting holes
 - Zinc plated finish for corrosion resistance
- 110591**

FIREWALL



1966-77 FORD BRONCO
FIREWALL ASSEMBLY

- High quality steel reproduction
 - Die stamped with high quality 18 gauge sheet metal
 - Features all original 1966 contour detail and cutouts
 - Coated with weldable primer
 - Fully assembled for quick drop in restorations
 - *Oversize freight policy*
- 110369**

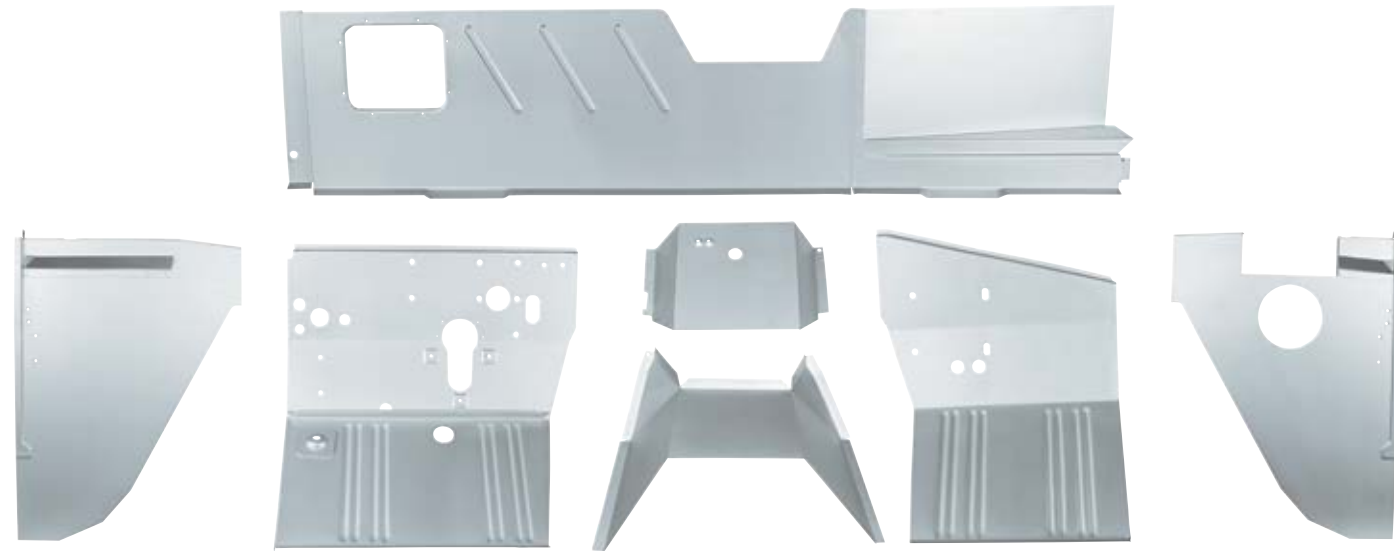

1966-77 FORD BRONCO

FIREWALL KIT

- Excellent quality steel Firewall Kit
 - Made with excellent quality 18 gauge sheet metal
 - Features all original 1966 contour detail and cutouts
 - Coated with weldable primer
 - Kit includes: left & right kick panel, left & right dash panel, upper & lower dash panel, cowl lower panel
 - User assembly is required
 - *Oversize freight policy*
- 110535**

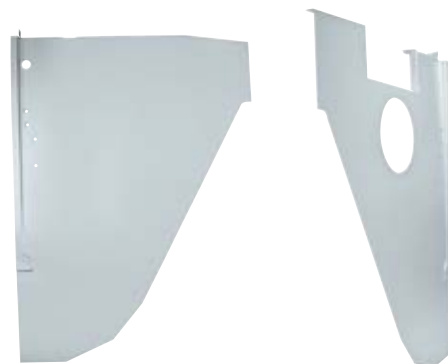

1966-77 FORD BRONCO
OUTER COWL SIDE PANEL

- Heavy 18 gauge stamped sheet metal as original
 - Coated in weldable primer
 - Sold individually, please specify left or right side
- 110240 | Driver LH**
110241 | Passenger RH

RADIATOR SUPPORT/WINDSHIELD FRAME

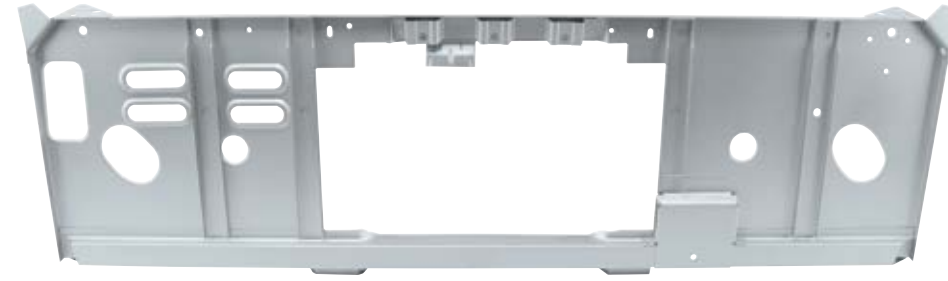

1966-77 FORD BRONCO
RADIATOR SUPPORT

- Die stamped 16 gauge sheet metal with reinforcing steel gussets
 - Includes heavy 12 gauge lower radiator support brackets & cradles
 - Coated in weldable primer
- 110385**



1966-77 FORD BRONCO
WINDSHIELD FRAME

- Accurate reproduction with all of the original contours and details
 - Roll-formed with 16 gauge steel, black EDP coated finish
 - Windshield frame includes windshield hinge attached
 - OEM Number: C9TZ-9703114-A
 - *Oversize freight policy*
- 110397**



1966-77 FORD BRONCO
WINDSHIELD FRAME HINGE

- Original piano hinge design
 - Heavy duty 16 gauge steel, black EDP coated finish
- 110398**



1968-77 FORD BRONCO
WINDSHIELD TO COWL MOUNT

- Essential component for connecting the firewall and the front windshield hinge
 - Die stamped with 18 gauge steel, coated in weldable primer
- 110349**



1966-77 FORD BRONCO
COWL BRACES 4PC. SET

- High quality 17 and 19 gauge stamped steel
 - Black EDP coated finish
 - Fill the empty upper corner area between the windshield cowl mount and the a-pillar
- 110590**

DASH ACC./WINDOW ASSEMBLY



1966-77 FORD BRONCO
DASH PANEL ASSEMBLY

- Die stamped with quality 20 gauge sheet metal
 - Features the later 73-77 original style contour and components cutouts
 - Single din radio cutout for easy installation of modern head units
 - Coated in weldable primer
- 110502**



1966-67 FORD BRONCO
VENT WINDOW HANDLES

- Beautifully die-cast and chrome plated as original
 - Includes mounting hardware
 - Sold in pair
- 110131**



1968-77 FORD BRONCO
VENT WINDOW HANDLES

- Beautifully die-cast and chrome plated as original
 - Includes mounting hardware
 - Sold in pair
- 110132**



1966-77 FORD BRONCO
CHROME VENT WINDOW ASSEMBLY

- Beautifully chrome plated
 - Fully assembled and ready to install
 - Sold individually, please specify left or right side
- 110218 | Driver LH**
110219 | Passenger RH



1966-77 FORD BRONCO
VENT WINDOW ASSEMBLY

- Retains all original contour and detail
 - Black coated inner frame with untinted glass
 - Chrome plated vent handle and outer frame with door window felt
 - Sold individually, please specify left or right side
- 110273 | Driver LH**
110274 | Passenger RH

DOOR SHELLS



1966-67 FORD BRONCO

DOOR SHELLS

- Die-stamped with high quality 20 gauge sheet metal, features all of the original 66-67 contour detail
 - Perfect for replacing that damaged door skin on the original door shell
 - Black EDP coated finish
 - Sold individually, please specify left or right side
- 110370 | Driver LH**
110371 | Passenger RH



1968-77 FORD BRONCO

DOOR SHELLS

- Die-stamped with high quality 20 gauge sheet metal, features all of the original 68-77 contour detail
 - Perfect for replacing that damaged door skin on the original door shell
 - Black EDP coated finish
 - Sold individually, please specify left or right side
- 110372 | Driver LH**
110373 | Passenger RH



1968-77 FORD BRONCO

DOOR SKIN

- Excellent 20 gauge stamped sheet metal reproduction of the door skin with all of the original contour detail
 - Perfect for replacing that damaged door skin on the original door shell
 - Black EDP coated finish
 - OEM Number: C9TZ-9720125-A
 - Sold individually, please specify left or right side
- 110356 | Driver LH**
110357 | Passenger RH

DOOR MOUNT/HANDLES



1966-77 FORD BRONCO

DOOR HINGE

- All mounting holes and threads fully machined & ready to install
- Precision steel for strength & durability
- Sold individually, please specify left or right side

110352 | Driver LH

110353 | Passenger RH



1966-77 FORD BRONCO

CHROME OUTSIDE DOOR HANDLE SET

- Beautiful chrome plated finish with triple chrome plating process
- Excellent reproduction with original contour and size
- Original style inner linkage design for straight forward replacement
- Complete set includes pair of handles, mounting pads and hardware included

110824

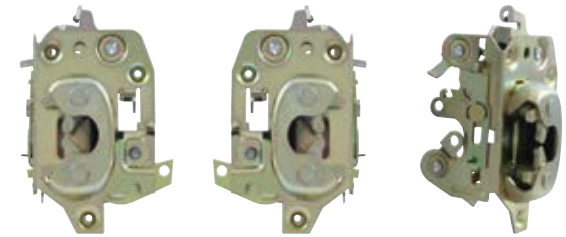

1968-77 FORD BRONCO

DOOR LATCHES

- Exact copy of the original Bronco door latch
- Precision stampings with original design mechanism
- Mounting hardware not included
- Sold individually, please specify left or right side

F20012 | Driver LH

F20013 | Passenger RH



WINDOW FRAME/REGULATORS

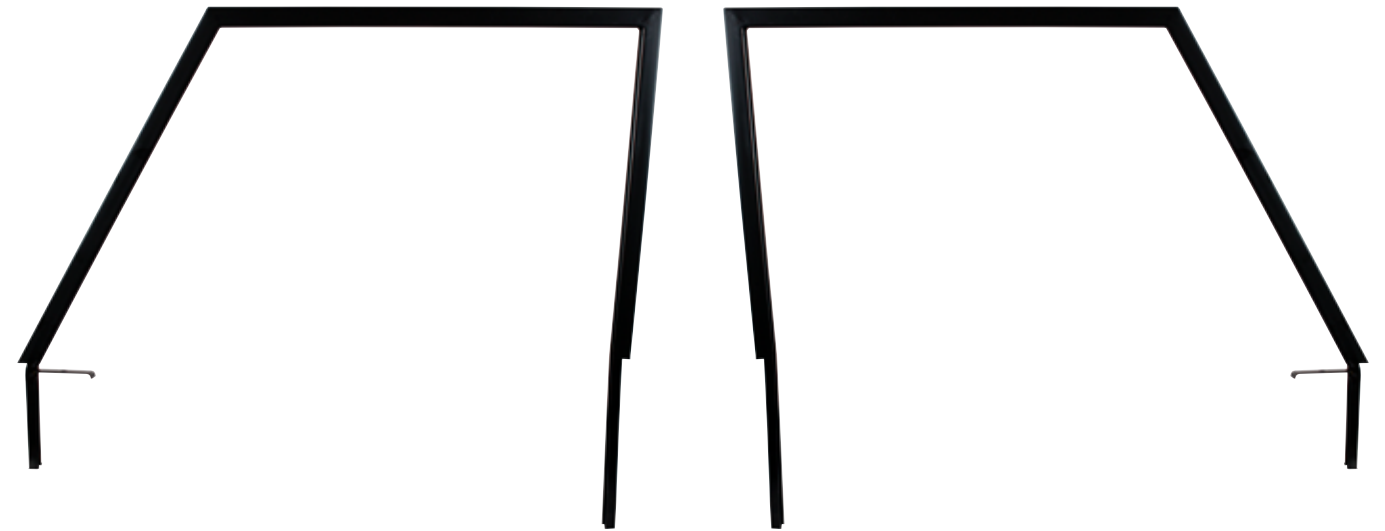

1966-68 FORD BRONCO

DOOR WINDOW FRAME

- Excellent steel reproduction with the original mounting design and contour
- Black EDP coated finish
- Thread plated welded to frame for easy mounting to door shell
- OEM #: C6TZ-9722220-A / C6TZ-9722221-A
- Sold individually, please specify left or right side

110478 | Driver LH

110479 | Passenger RH

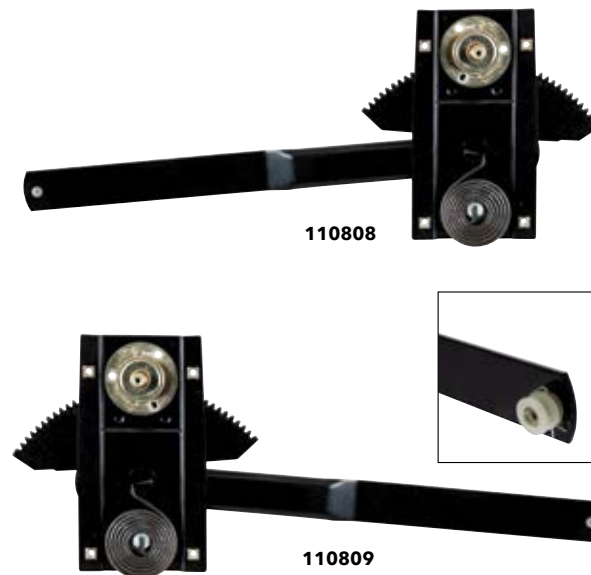

1966-77 FORD BRONCO

WINDOW REGULATOR

- Excellent quality high strength steel stamping
- Original style counter balance spring design
- Window channel roller and retainer ring included
- Replaces OEM number: 710270058501 (L/H / 710270058518 (R/H)
- Sold individually, please specify left or right hand side

110808 | Driver LH

110809 | Passenger RH

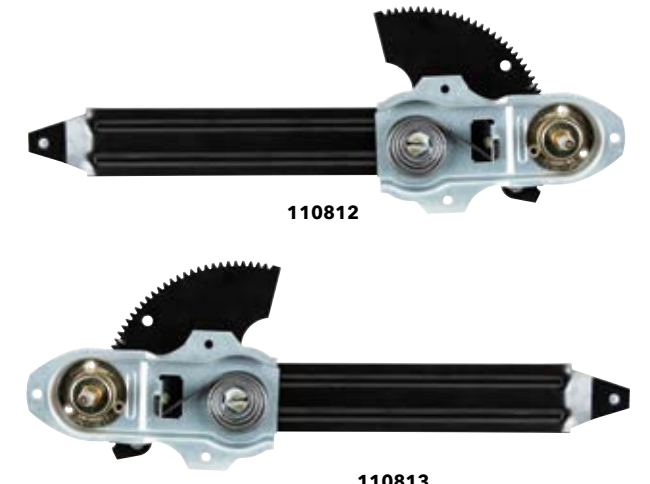

1973-79 FORD BRONCO

WINDOW REGULATOR

- Excellent quality high strength steel stamping
- Original style counter balance spring design
- OEM specification for easy installation
- Replaces OEM number: 710270058549 (L/H / 710270058556 (R/H)
- Sold individually, please specify left or right hand side

110812 | Driver LH

110813 | Passenger RH

REAR VIEW MIRRORS

1966-77 FORD BRONCO

CHROME EXTERIOR MIRROR

- Exceptional quality die cast metal and beautifully chrome plated
 - Includes mounting pad and screws
 - Fits L/H or R/H side
 - Sold each
- 110735**



1966-77 FORD BRONCO

CHROME EXTERIOR MIRROR W/LED TURN SIGNAL

- Exceptional quality die cast metal and beautifully chrome plated
 - Special behind-the-mirror LED design, hidden when not in use
 - Easy 12V hookup, just route wire through door jamb and connect to front turn signal wires under dash near steering column
 - Includes mounting pad and screws
 - Sold each
- 110736**



1966-77 FORD BRONCO

CHROME EXTERIOR CONVEX MIRROR

- Exceptional quality die cast metal and beautifully chrome plated
 - Convex mirror for wide angle visibility
 - Includes mounting pad and screws
 - Sold each
- 110737**

REAR VIEW MIRRORS



DOOR PILLARS



1966-67 FORD BRONCO

A-PILLAR HINGE JAMB POST

- Excellent stamped 17 gauge sheet metal
- Exact duplicate of the factory OEM door pillar
- Has heavy duty hinge backing plates as original with 5/16-18 thread
- Coated in weldable primer
- Sold individually, please specify left or right side
- OEM#: C6TZ-9602501-A

110233 | Driver LH

110234 | Passenger RH



1968-77 FORD BRONCO

A-PILLAR HINGE JAMB POST

- Excellent stamped 17 gauge sheet metal
- Exact copy of the original bronco a-pillars
- Coated in weldable primer
- Sold individually, please specify left or right side

110509 | Driver LH

110510 | Passenger RH



1966-77 FORD BRONCO

B-PILLAR REINFORCEMENT

- Stamped heavy 16 gauge sheet metal
- Exact copy of the original Bronco b-pillars
- Coated in weldable primer
- Sold individually, please specify left or right side

110511 | Driver LH

110512 | Passenger RH



1966-67 FORD BRONCO

DOOR STRIKER KIT

- Heavy duty steel reproduction of the original striker
- Round latch stud
- Includes one shim and two 5/16 - 18 screws
- Fits both the left or right hand side

110476



1968-77 FORD BRONCO

DOOR STRIKER KIT

- Heavy duty steel reproduction of the original striker
- Original style oval latch stud
- Includes two shims and two 5/16 - 18 screws
- Fits both the left or right hand side

110477

PILLARS/ROCKER PANELS



1968-77 FORD BRONCO

B-PILLAR DOOR JAMB

- Excellent die stamped 17 gauge sheet metal reproduction of the door B-pillar jamb post with all of the original contour detail
- Includes door latch striker plate, striker plate shims, striker plate screws & upper corner filler strip
- Coated in weldable primer
- Sold individually, please specify left or right side
- OEM Number: C8TZ-9628161-A

110354 | Driver LH

110355 | Passenger RH



1966-67 FORD BRONCO

B-PILLAR DOOR JAMB

- Excellent stamped 17 gauge sheet metal
- Features all original contour and detail
- Caged striker mounting plate with 5/16-18 tapped holes
- Includes upper pillar post extension
- Coated with weldable primer
- Sold individually, please specify left or right side

110474 | Driver LH

110475 | Passenger RH

1968-77 FORD BRONCO

INNER ROCKER PANEL

- Excellent reproduction of the original inner rocker panel with all contour detail
- Made with 18 gauge steel, coated in weldable primer
- Sold individually, please specify left or right side
- OEM Number: C6TZ-16505-A

110269 | Driver LH

110270 | Passenger RH



1966-77 FORD BRONCO

ROCKER PANEL

- Excellent stamped sheet metal reproduction of the rocker panel with all of the original contour detail
- Die stamped with 18 gauge steel
- Coated in weldable primer
- Fits both the left and right hand sides

110336



FLOOR PAN/BRACES



1968-77 FORD BRONCO FRONT FLOOR PAN ASSEMBLY

- Heavy 18 gauge stamped sheet metal as original
 - Fully assembled with inner rocker panels, under floor braces, and supports
 - Coated in weldable primer
 - *Oversize freight policy*
- 110504**

1966-67 FORD BRONCO FLOOR PAN BRACES

- Center and front floor pan brace made out of 14 gauge stamped sheet metal
 - Rear floor pan brace made out of 15 gauge stamped sheet metal
 - Coated in weldable primer
 - Sold separately, please specify center, front, or rear
- 110235 | Center Floor Pan Brace**
110236 | Front Floor Pan Brace
110237 | Rear Floor Pan Brace



1966-77 FORD BRONCO FRONT FLOOR PAN SUPPORT BRACES

- Heavy 14 gauge stamped sheet metal as original
 - Coated in weldable primer
 - Sold in sets
- 110242**

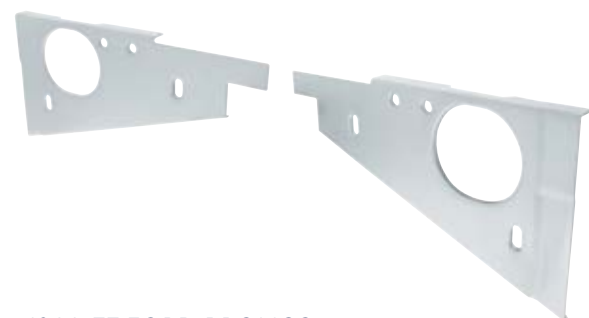

1966-77 FORD BRONCO REAR FLOOR PAN SUPPORT BRACES

- Heavy 14 gauge stamped sheet metal as original
 - Coated in weldable primer
 - Sold in sets
- 110238**

WHEELHOUSE/BRACES

1966-77 FORD BRONCO

WHEELHOUSE

- High quality 18 gauge stamped steel reproduction
 - Features all original design and tough spot welded construction
 - L/H side require modification for Bronco with power steering or power brake
 - Coated with weldable primer
 - Sold individually, please specify left or right side
- 110366 | Passenger RH**
110367 | Driver LH

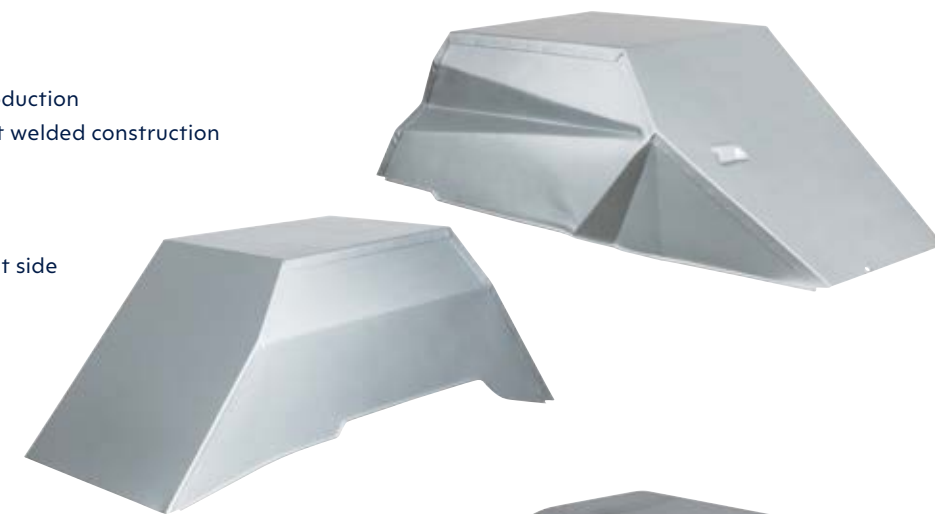

1966-77 FORD BRONCO

INNER REAR WHEELHOUSE

- Heavy 18 gauge stamped sheet metal as original
 - Coated in weldable primer
 - Sold individually, please specify left or right side
- 110277 | Passenger RH**
110278 | Driver LH



1966-77 FORD BRONCO

WHEELHOUSE TO CORE SUPPORT BRACES

- Heavy duty 14 gauge sheet metal
 - Body mount bracket comes spot welded for easy and quick body to frame mounting
 - Features mounting holes on each brace for battery tray installation
 - Coated with weldable primer
 - 3 Piece set
- 110368**

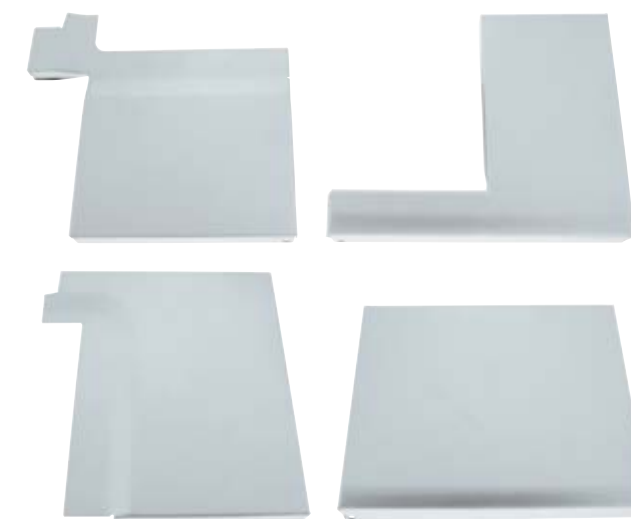

1966-77 FORD BRONCO

WHEELHOUSE FILLER PLATES

- Heavy 15 gauge stamped sheet metal as original
 - Modification required for installation on 1977 Bronco
 - Coated in weldable primer
 - Sold individually, please specify left or right side
- 110275 | Passenger RH**
110276 | Driver LH

CORNER/QUARTER PANELS



1966-77 FORD BRONCO

BED STAKE CORNER

- Quality 16 gauge die stamped sheet metal reproduction with all of the original contour detail
 - Coated in weldable primer
 - Sold individually, please specify left or right side
- 110350 | Driver LH**
110351 | Passenger RH



1966-77 FORD BRONCO

TAIL LIGHT HOUSING CORNER PANEL

- Heavy 17 gauge stamped sheet metal as original
 - Coated in weldable primer
 - Sold individually, please specify left or right side
- 110271 | Driver LH**
110272 | Passenger RH



1966-77 FORD BRONCO

LOWER QUARTER PANEL SKIN

- Fix that cut-up Bronco with fresh new 20 gauge sheet metal quarter panels
 - Full panels from seam to seam (not patches)
 - Coated in weldable primer
 - Sold individually, please specify left or right side
- OEM#: C6TZ-962781-A
110334 | Driver LH
110335 | Passenger RH



1966-77 FORD BRONCO

BED/INNER QUARTER PANEL

- This panel is the cap of the quarter panel and Inside panel of the bed area
 - Made with quality 17 gauge sheet metal
 - Coated in weldable primer
 - Sold individually, please specify left or right side
- OEM#: C6TZ-9627815-A
110332 | Driver LH
110333 | Passenger RH

CARGO BED/TAILGATE



1966-77 FORD BRONCO

CARGO BED / FLOOR PAN

- Die stamped with quality 17 gauge sheet metal
 - Features all original grooves and mounting holes
 - Coated in weldable primer
 - *Oversize freight policy*
- 110328**

1966-77 FORD BRONCO

TAILGATE

- Plain style tailgate without Ford letters
 - High quality heavy 16 gauge steel aftermarket reproduction of the original Ford tailgate
 - Precision cut latch handle pocket with 1/4"-20 welded nuts and recessed mounting holes on the inside panel
 - Includes tailgate linkage posts, tailgate trunnion pockets, and latch pockets with 5/16"-18 threaded holes
 - Features license plate light pocket, wiring holes, and small 0.087" diameter mounting holes
 - Finished with black EDP protective coating to keep your new steel fresh and rust-free
- 110884**



1966-77 FORD BRONCO

BED SUPPORT CROSS RAIL

- Die stamped with heavy 14 gauge sheet metal
 - Features all original contour and detail
 - Coated in weldable primer
- 110327**

1978-86 FORD BRONCO

TAILGATE SILL PLATE

- Quality aluminum extrusion with clear anodized finish
 - Machine drilled mounting hole with countersink
 - Mounting hardware included
- 110791**





1966-77 FORD BRONCO

289/302/351W LONG TUBE HEADERS

- Fits all 1966-77 Broncos with a 289, 302, or 351W V8 engine
- Extra-thick 16 gauge 1 1/2" mandrel-bent tube
- 3/8" thick laser cut flanges resist warping
- Designed to provide ample clearance for tight areas
- Long tube design delivers maximum horsepower and torque
- Finished with Hi-Temp black paint, slowly fades to a matte grey after use or metallic ceramic coating, for better heat, rust, and scratch resistance
- Kit includes: Left & Right headers, exhaust gaskets, 3" collectors, collector gaskets, and all necessary header bolts, sold in pairs

110588 | Black

110589 | Metallic

FUEL TANK/BATTERY TRAY



1966-77 FORD BRONCO

BATTERY TRAY

- Excellent reproduction of the original design
 - Die stamped steel, painted black
- 110557**



1966-69 FORD BRONCO

BATTERY HOLD-DOWN BRACKET

- Anti-corrosive vinyl plastisol coating
- 110522**



1966-76 FORD BRONCO

FUEL SENDING UNIT

- Made with corrosion resistant stainless steel
 - Brass float just like the original
 - Includes rubber seal, stainless steel lock ring, and strainer
- 110664**



1966-77 FORD BRONCO

AUXILIARY FUEL TANK SENDING UNIT

- Made with corrosion resistant stainless steel
 - Brass float just like the original
 - Includes rubber seal, stainless steel lock ring, and strainer
- 110665**



1966-77 FORD BRONCO

BATTERY HOLD-DOWN "J" BOLT SET

- Anti-corrosive coating, zinc plated
 - Sold in pair
- 110523**



1966-77 FORD BRONCO

FUEL TANK

- Die stamped with Ni-Terne treated steel sheet
 - Features all of the original detail and contour
 - Approximately 13 gallon fuel capacity
 - Precision notched fuel tank strap recesses for better positioning during installation
- 110561**



1966-77 FORD BRONCO

TANK FILLER GUARD SET

- Made with high quality 17 gauge sheet metal
 - Has identical curvature and detail as original
 - Coated in weldable primer for easy attachment to wheel house and inner quarter panel
 - Front and back guard included
- 110331**

VENTS/WIPER ARMS/WINDOW PROP



1966-77 FORD BRONCO

HEATER VENT

- Injection molded with high quality plastic
 - Has all of the original contour and mounting holes
- 110330**



1966-77 FORD BRONCO

HEATER BOX

- Accurate reproduction heater box
 - Features original style defroster duct selector
 - Original style speed nuts included for fan motor mounting
- 110329**



1966-77 FORD BRONCO

WIPER ARM & BLADE KIT

- Perfect upgrade for classic 1966-77 Ford Broncos
 - Polished stainless steel wiper arms with chrome plated shaft mounts
 - Kit includes two wiper arms and two 12" wiper blades
- 110299**



1966-77 FORD BRONCO

FRESH AIR VENT BOX

- Driver side air vent box with door
 - Includes foam seals throughout the box like the factory original
- 110239**
Air Vent Box Foam Gasket available separately
110095



1966-77 FORD BRONCO

REAR WINDOW PROP

- Accurate reproduction of the steel rear window props with toggle latch mechanism as original
 - Bright zinc plated as original
 - Sold in pair
- 110399**

LED HEADLIGHTS



7" 5 LED DUAL FUNCTION HEADLIGHT-CHROME

- 5 High power LED 7" headlight, Philips Lumileds
 - Reinforced aluminum reflector, rugged anti-vibration construction
 - Improved visibility with whiter light output that is closer to the color temperature of daylight
 - DOT and SAE compliant, sold individually
- 31391**



7" 5 LED DUAL FUNCTION HEADLIGHT-BLACK

- 5 High power LED 7" headlight, Philips Lumileds
 - Reinforced aluminum reflector, rugged anti-vibration construction
 - Improved visibility with whiter light output that is closer to the color temperature of daylight
 - Sold individually
- 31289**



LED HEADLIGHTS



7" LED DUAL FUNCTION HEADLIGHT

- High power LED 7" headlight with durable corrosion resistant polycarbonate lens & housing
 - Solid state design resists shock and vibration
 - Easy connection, fits OEM housing, plugs into existing wiring harness, position light requires additional wiring
 - Low beam 500 lumens, 12-24V DC input, high beam 950 lumens
- 31084**



7" HIGH POWER LED CRYSTAL HEADLIGHT-CHROME

- 11 High power LED 7" crystal headlight, SAE/DOT FMVSS108
 - Impact resistant polycarbonate lens provides unparalleled protection from road hazards
 - Improved visibility with whiter light output that is closer to the color temperature of daylight
 - Die-cast aluminum housing provides maximum protection from the elements. Sold individually
- 31355**



7" HIGH POWER LED CRYSTAL HEADLIGHT-BLACKOUT

- 11 High power LED 7" crystal headlight, SAE/DOT FMVSS108
 - Impact resistant polycarbonate lens provides unparalleled protection from road hazards
 - Improved visibility with whiter light output that is closer to the color temperature of daylight
 - Die-cast aluminum housing provides maximum protection from the elements. Sold individually
- 31353**

LED HEADLIGHTS



7" HIGH POWER LED PROJECTION HEADLIGHT W/ LED HALO RING

- 7" High power LED projection headlight with dual function 60 LED halo ring
- Dual color white/amber auxiliary LED halo ring with amber automatic override feature
- Die-cast housing and polycarbonate lens provide maximum protection and durability
- Solid state design resists shock and vibration, IP67 weatherproof rating
- DOT and SAE compliant, sold individually

31496



7" HIGH POWER LED HEADLIGHT W/ LED POSITION LIGHT BAR

- High power LED 7" headlight with white LED turn signal/position light bar
- Easy installation, fits OEM housing, plugs into existing wiring harness
- LED position light requires additional wiring, pre-wired with 0.156" diameter male bullet
- Low beam 900 lumens, high beam 1300 lumens. Sold individually

31459



7" HIGH POWER LED HEADLIGHT W/ LED POSITION LIGHT BAR

- High power LED 7" headlight with amber LED turn signal/position light bar
- Easy installation, fits OEM housing, plugs into existing wiring harness
- LED position light requires additional wiring, pre-wired with 0.156" diameter male bullet
- Low beam 900 lumens, high beam 1300 lumens. Sold individually

31458

LED HEADLIGHTS



7" HIGH POWER LED HEADLIGHT W/ LED POSITION LIGHT BAR

- High power LED 7" headlight with durable corrosion resistant polycarbonate lens & housing
- Solid state design resists shock and vibration
- Easy connection, fits OEM housing, plugs into existing wiring harness, position light requires additional wiring
- Low beam 1,000 lumens, high beam 2,000 lumens

31200



7" HIGH POWER LED HEADLIGHT W/ LED POSITION LIGHT BAR

- 3 High power LED 7" headlight w/ 10 LED daytime running light bar
- 900 Lumen output on low and 1,600 lumen output on high
- White position light bar can be wired as daytime running light, amber position light bar can be wired as turn signal
- Easy installation, fits OEM housing, plugs into existing wiring harness
- DOT and SAE compliant, sold individually

31513



7" HIGH POWER LED HEADLIGHT W/ LED POSITION LIGHT BAR

- 3 high power LED 7" headlight w/ 10 LED daytime running light bar
- 900 lumen output on low and 1,600 lumen output on high
- White position light bar can be wired as daytime running light, amber position light bar can be wired as turn signal
- Easy installation, fits OEM housing, plugs into existing wiring harness
- DOT and SAE compliant, sold individually

31514

LED HEADLIGHTS



7" CRYSTAL HEADLIGHT W/ LED POSITION LT

- 7" crystal headlight with 6 hi/low function amber LED position lights
- Reinforced aluminum reflector with rugged anti-vibration construction
- DOT/SAE Hr 15, LED for auxiliary/utility purposes, sold individually
- Includes 9007 halogen bulb and seal beam/H4 plug adapter
- 12V, dual function auxiliary LEDs have three wire hookup

31247



7" CRYSTAL HEADLIGHT W/ AMBER LED HALO RING

- 7" Crystal headlight with amber LED halo ring and 9007 bulb
- Reinforced multi-surfaced, aluminum reflector
- Sold Individually

31284



7" CRYSTAL HEADLIGHT W/ WHITE LED HALO RING

- 7" Crystal headlight with white LED halo ring and 9007 bulb
- Reinforced multi-surfaced, aluminum reflector
- Sold Individually

31285

LED HEADLIGHTS



7" CRYSTAL HEADLIGHT WITH 34 AMBER AUXILIARY LED

- 34 amber LEDs with clear lens
- Anti-vibration structural design with reinforced multi-surfaced aluminum reflector housing
- H4/HB2/9003 halogen bulb: 12V 65/55W, replaces H6017/H6024
- HB2/9003 DOT/SAE code: DOT SAE-HR1-01
- Sold individually

31378



7" CRYSTAL HEADLIGHT WITH 34 WHITE AUXILIARY LED

- 34 white LEDs with clear lens
- Anti-vibration structural design with reinforced multi-surfaced aluminum reflector housing
- H4/HB2/9003 halogen bulb: 12V 65/55W, replaces H6017/H6024
- HB2/9003 DOT/SAE code: DOT SAE-HR1-01
- Sold individually

31379



7" HALOGEN SEALED BEAM HEADLIGHT

- 7" round sealed beam headlight by Wagner
- 12 Volt, 60/35W, replaces halogen, H6014/H6024, high and low beam functions
- Sold individually

30356

LED TAIL LIGHT & BEZEL UPGRADE



1. Unscrew and remove lens

2. Remove halogen bulb

3. Insert LED Upgrade Board onto Lens



4. Plug in Sequential Tail Light

5. Install Tail Light Lens Gasket and Bezel

6. Install complete

TAIL LIGHT BEZELS/LENS

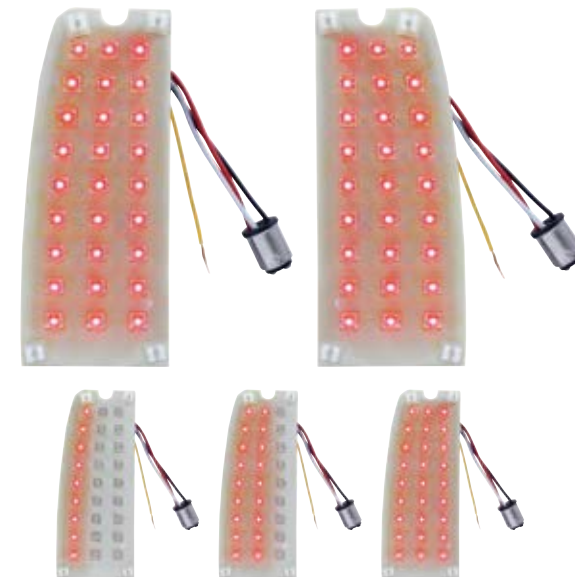

1967-77 FORD BRONCO & 1967-72 FORD TRUCK LED SEQUENTIAL TAIL LIGHT INSERT BOARDS

- Super bright led circuit board installs behind existing lens
 - Dual function with tail light & bright stop/turn signal
 - Features sequential operation with selector switch to select sequential function ON/OFF
 - Features sequential once brake attention function
 - Easy electrical connection with 1157 plug, no modification
 - Requires United Pacific LED turn signal flasher, item # 90652
 - Sold in pairs
- 110497**

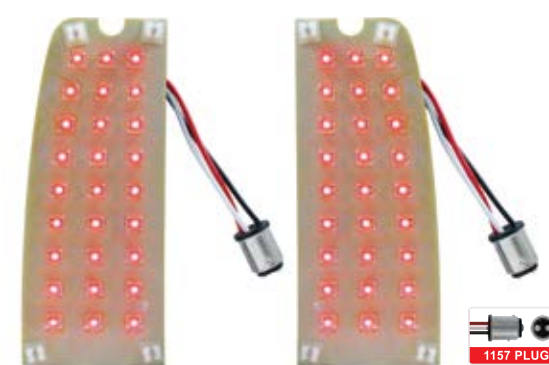

1966-77 FORD BRONCO & 1967-72 FORD TRUCK LED TAIL LIGHT INSERT BOARDS

- Super bright LED circuit board installs behind existing lens
 - Dual function with tail light & bright stop/turn signal
 - Epoxy coated, fully sealed electronics
 - Easy electrical connection with 1157 plug, no modification
 - Requires United Pacific LED turn signal flasher, item # 90652
 - Sold in pairs or individually
- FTL6772LED-PR | Pair**
FTL6772LED-L | Left
FTL6772LED-R | Right



1966-77 FORD BRONCO

BILLET ALUMINUM TAIL LIGHT BEZELS

- CNC milled out of a single solid aluminum block
 - Durable anodized for a tough off-road look
 - Fits to the original tail light lens mounting holes
 - Foam gaskets and socket head screws included
 - Sold as set
- 110583 | CLEAR ANODIZED**
110584 | SATIN BLACK ANODIZED

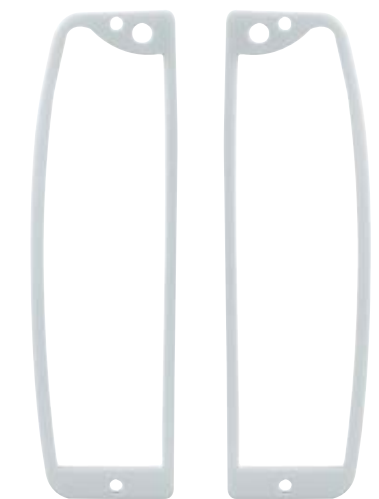

1966-77 FORD BRONCO

TAIL LIGHT LENS GASKET

- Fits between tail light housing and lens
 - White foam rubber as original
 - Sold in pairs
- F677203**

TAIL LIGHTS



1978-79 FORD BRONCO

TAIL LIGHT LENS

- Great looking replacement lens
- Injection molded from high quality polycarbonate plastic
- Sold individually, please specify driver side or passenger side

110112 | Driver LH

110113 | Passenger RH



1987-89 FORD BRONCO & STYLESIDE TRUCK

TAIL LIGHT ASSEMBLY

- Great looking replacement lens for 1987-89 full size Bronco & Styleside Truck
- Sold individually, please specify driver side or passenger side

110170 | Driver LH

110171 | Passenger RH

1990-96 FORD BRONCO & STYLESIDE TRUCK

TAIL LIGHT ASSEMBLY

- Great looking replacement lens for 1990-96 full size Bronco & Styleside Truck
- High quality injection molded polycarbonate lens
- Fully assembled for easy and straight forward replacement
- Sold individually, please specify driver side or passenger side

110172 | Driver LH

110173 | Passenger RH

LED PARKING LIGHTS

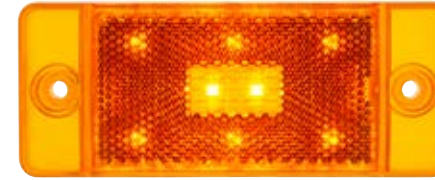

1970-77 FORD BRONCO

LED PARKING/SIGNAL LIGHT-FRONT

- 8 LED dual function, parking light and turn signal
- Super bright amber LED with amber acrylic lens
- Epoxy coated, fully sealed electronics
- Fits left hand and right hand

110804 | AMBER

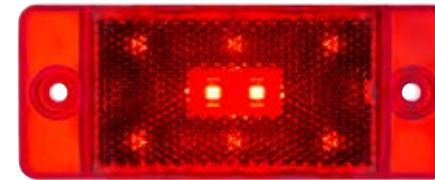

1970-77 FORD BRONCO

LED PARKING/SIGNAL LIGHT-REAR

- 8 LED dual function, parking light and turn signal
- Super bright amber LED with red acrylic lens
- Epoxy coated, fully sealed electronics
- Fits left hand and right hand

110805 | RED

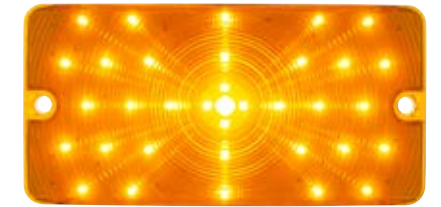

1969-77 FORD BRONCO

LED PARKING/SIGNAL LIGHT

- 35 LED dual function, parking light and turn signal
- Super bright amber LED with amber acrylic lens
- Epoxy coated, fully sealed electronics, 1157 plug
- Fits left hand and right hand
- Also fits 1959-64 Ford F100, F250, F350, and 1968-74 Econoline

110382 | LED Parking/Signal Light

110803 | Front Parking Light Gasket



CONVENIENT GOODS



AIR COMPRESSOR AND TANK KIT

- High volume reciprocating compressor with 1.5 gallon tank
 - Powerful motor fills aux tank from empty to full in just 2 minutes
 - Pre-installed top mount pressure gauge and auto on/off sensor to ensure the tank is always full and ready
 - Drain valve with t-handle located directly under the tank
 - Coiled nylon air hose included with fittings
 - 140 psi for air horns, on-board air applications & off-road use
 - Compressor & tank can be stacked together, or mounted separately
- 46154**



BRONCO KEYCHAIN/BOTTLE OPENER

- Quality chrome plated die cast with triple chrome plating process
 - Heavy duty, quality you can feel
 - Round split keychain ring included
- 99102**

ACCESSORIES/T-SHIRTS



UNITED PACIFIC LB T-SHIRT

- 100% cotton fatigue green t-shirt
 - 1 color front print
- 99180M | MEDIUM**
99180L | LARGE
99180XL | X-LARGE
99180XXL | XX-LARGE



10 Quarts
Capacity



23 Quarts
Capacity



DA COOLBOX THERMOELECTRIC COOLER/WARMER

- Da CoolBox 10 Quart thermoelectric cooler/warmer
 - Cools without ice, making more space for food and drinks
 - Great for travel to keep your contents fresh and dry
 - Shoulder strap for easy transportation
 - USB charging port for mobile devices
 - Selector switch for cool/heat
 - Solid, strong exterior for added durability
- 99121**



DA COOLBOX THERMOELECTRIC COOLER/WARMER

- Da CoolBox 23 Quart thermoelectric cooler/warmer
 - Cools without ice, making more space for food and drinks
 - Great for travel to keep your contents fresh and dry
 - Shoulder strap for easy transportation
 - USB charging port for mobile devices
 - Digital LCD display and temperature adjustment control
 - Solid, strong exterior for added durability
- 99122**



PINSTRIPES T-SHIRT

- 100% cotton black t-shirt
 - 1 color front print, 4 color back print
- 99082M | MEDIUM**
99082L | LARGE
99082XL | X-LARGE
99082XXL | XX-LARGE



BRONCO T-SHIRT

- United Pacific SEMA 2018 Ford Bronco concept graphic
 - 100% cotton black t-shirt, 1 color front print, 4 color back print
- 99129M | MEDIUM**
99129L | LARGE
99129XL | X-LARGE
99129XXL | XX-LARGE

PRODUCT INDEX

ITEM#	PAGE#	ITEM#	PAGE#	ITEM#	PAGE#
30356	40	110328	30	110513	13
31084	36	110329	34	110515	13
31200	38	110330	34	110516	13
31247	39	110331	33	110522	33
31284	39	110332	29	110523	33
31285	39	110333	29	110535	17
31289	35	110334	29	110536	15
31353	36	110335	29	110539	16
31355	36	110336	26	110557	33
31378	40	110349	18	110561	33
31379	40	110350	29	110583	42
31391	35	110351	29	110584	42
31458	37	110352	21	110588	32
31459	37	110353	21	110589	32
31496	37	110354	26	110590	18
31513	38	110355	26	110591	16
31514	38	110356	20	110592	16
46154	45	110357	20	110593	16
50130	14	110364	16	110594	14
99102	46	110365	16	110596	16
99121	45	110366	28	110664	33
99122	45	110367	28	110665	33
110095	34	110368	28	110735	23
110112	43	110369	17	110736	23
110113	43	110370	20	110737	23
110131	19	110371	20	110791	30
110132	19	110372	20	110803	44
110170	43	110373	20	110804	44
110171	43	110382	44	110805	44
110172	43	110385	18	110808	22
110173	43	110397	18	110809	22
110218	19	110398	18	110812	22
110219	19	110399	34	110813	22
110233	25	110460	11	110824	21
110234	25	110461	12	110884	30
110235	27	110462	12	99082L	46
110236	27	110463	15	99082M	46
110237	27	110464	15	99082XL	46
110238	27	110465	15	99082XXL	46
110239	34	110466	15	99129L	46
110240	17	110474	26	99129M	46
110241	17	110475	26	99129XL	46
110242	27	110476	25	99129XXL	46
110269	26	110477	25	99180L	46
110270	26	110478	22	99180M	46
110271	29	110479	22	99180XL	46
110272	29	110482	14	99180XXL	46
110273	19	110497	42	F20012	21
110274	19	110499	14	F20013	21
110275	28	110502	19	F677203	42
110276	28	110504	27	FTL6772LED-L	42
110277	28	110509	25	FTL6772LED-PR	42
110278	28	110510	25	FTL6772LED-R	42
110299	34	110511	25		
110327	30	110512	25		





United Pacific



CLASSIC CAR & TRUCK

LED LIGHTING



QUALITY

With over 30 years of experience in the automotive aftermarket industry, United Pacific Industries understands the rigors and stresses that our products are subjected to on the road. It is our mission to provide our customers with products of superior quality and reliability. In achieving this goal, United Pacific only partners with manufacturing facilities that conforms to our quality control requirements and standards. Our manufacturing partners meet or exceed ISO-9001 requirements. In addition, United Pacific's manufacturing partners must be equipped on site to perform the following quality assurance tests and maintain a track record of consistent quality and low product failure rate.

- Aging Test
- Air Tight Test
- Dust Test
- Flux Test
- Photometric Test
- Pull Force Test
- Rain Test
- Salt Spray Test
- Shock Test
- Temperature Test
- Humidity Test
- Vibration Test

Furthermore, our internal quality control structure allows us to function as the final quality control station prior to shipping. With the assistance of 3D computer technology, United Pacific can adhere to strict quality control standards during prototype creation and the production process. Our engineers and technicians perform a battery of tests to ensure that our products meet the demands of today's drivers and our goal to be first in quality.

INNOVATION

Known as the leader in innovation, United Pacific is dedicated to be the first to bring new and exciting products to the market. United Pacific's global expertise allows us to search the globe for new ideas and concepts. Not only do we search the globe for new products, United Pacific invest a significant amount of resources into our own research and development efforts. With the assistance of advance 3D scanning technology, our engineers and designers can acquire accurate and precise data in seconds.

The 3D data allows United Pacific to verify designs, perform quality assurance tests, and reverse engineer with unprecedented speed and accuracy. Digital inspection contributes to the early detection of shape problems, provides rapid feedback on design, and eliminates unnecessary work in downstream processes. Our rapid prototyping facility permits us to have a concept-to-shelf time of less than 5 months. In addition, United Pacific's 3D printing capabilities permit our designers to have physical models of their design concepts in hours. The physical models allow our designers and marketing staff to evaluate and test the viability of different design ideas. Our rapid prototyping facility allow United Pacific to compress design cycles, improve manufacturing planning, shorten concept-to-shelf time, most importantly, generate new and innovative products.

DESIGN

Located near some of the nation's most progressive automotive design centers, United Pacific established the UP Design Studio in 2002 to consolidate our position as the design leader in the automotive industry. UP Design Studio utilizes the latest generation of computer aided design (CAD) and studio/graphic software. The design studio is equipped with the newest computers and rapid prototyping systems. In addition, UP Design Studio is staffed by graduates from the nation's most prestigious design colleges. Unlike our competitors, United Pacific's design and manufacturing capabilities mean that we carry more new and original items than our competitors. The establishment of the design studio will enable us to generate even more new products with significant shorter concept-to-shelf time. The reduction in development cost mean that we can develop products utilizing design based development processes. Design based product development allows United Pacific to create new product concepts based on designs incorporating driver demands and needs instead of economic considerations. United Pacific's emphasis on design distinguishes and positions us ahead of our competitors.



WARRANTY

With LED (Light Emitting Diodes) rated at 100,000 hours of operation and solid-state construction, United Pacific's LED lights are extremely reliable and durable. Purchase with confidence, United Pacific offers a complete line of LED lighting products with extended or limited lifetime warranties. Please see the warranty policy page for more details.



HARD AT WORK FOR THE ENVIRONMENT



United Pacific
132,000 sq ft

Distribution Center
Long Beach, CA

100%

reduction in potable water used for landscaping

40%

reduction in total energy use due to high-efficiency mechanical and lighting systems

82%

of construction waste was diverted from landfills

LEED ACCOMPLISHMENTS

Sustainable Sites

- On-site bicycle storage, showers and changing areas for company employees.
- Preferred parking for low-emitting, fuel-efficient and carpool vehicles.
- Storm water is infiltrated on-site and treated to remove contaminants to reduce environmental impact on local waterways.

Water Efficiency

- In addition to using reclaimed water, drought-tolerant plants and a high-efficiency irrigation system were installed to reduce the use of potable water for irrigation by 100%.

Energy and Atmosphere

- Efficient HVAC equipment and a lighting system with daylight controls reduces energy consumption by over 30%.
- Enhanced commission verifies that the building's energy and water-related systems are performing as intended by the initial design.

Indoor Environmental Quality

- Building ventilation systems was designed to provide enhanced levels of fresh outside air to building occupants.
- Interior finishes (plants, sealants, adhesives, coatings, carpet systems and composite wood) were selected with low levels of volatile organic compounds (VOCs) to reduce indoor air contamination.



TABLE OF CONTENTS

CLASSIC CAR & TRUCK LED LIGHTING

LED HEADLIGHTS

7" Round LED Headlights	07
5 3/4" Round LED Headlights	12
7" Guide Style LED Headlights	13
5"x7" Rectangular LED Headlights	32
4"x6" Rectangular LED Headlights	33
LED Bulbs/Adaptors	40

CHEVY LED LIGHTS

1930's Chevy	43
1940's Chevy	49
1950's Chevy	51
Chevy Camaro	61
Chevy Chevelle/Malibu	66
Chevy Corvette	69
Chevy Corvette/El Camino	72
Chevy El Camino/Wagon	73
Chevy Impala	74
Chevy Nova	79
1940s-50s Chevy Truck	81
1950s-60s Chevy Truck	83
1960-66 Chevy Truck	87
C10 Chevy Truck	89

FORD LED LIGHTS

1928-34 Ford	98
1930s-40s Ford	107
1940s-50s Ford	117
Ford Mustang	123
Ford Thunderbird	126
Ford Truck/Bronco	127

PONTIAC LED LIGHTS

1950s Pontiac	131
---------------	-----

WILLIES/DODGE/VOLKS. LED LIGHTS

Willies/Dodge/Volkswagen	132
--------------------------	-----

HONDA/PEDESTAL/BULLET LIGHTS

Honda/Pedestal/Bullet Lights	133
------------------------------	-----

MISC. LIGHTING PRODUCTS

Rod and Bullet Lights	137
Brake/Tail/Cab Lights	139
Bullet Marker/Fastener Lights	141
Accessory Lights	143
LED Light Bars	145
LED License Light	149
Light Bulbs	155
LED Flashers/Load Resistors	160
Wiring/Plug Adaptors	162

WARRANTY AND TERMS

Terms & Conditions/Ordering/Freight	163
Shipping/Policy/Claims	164
Warranty Policy>Returns	165
Returns/Disclaimer	166

PRODUCT INDEX

Product Index	167
---------------	-----



LED LIGHTS
7" HEADLIGHTS



7" LED Projection Headlight W/ Dual Function LED Halo

- 7" headlight: 2,700 lumen high beam and 1,200 lumen low beam
- Dual color white/amber auxiliary LED halo ring with amber automatic override feature
- Die-cast housing and polycarbonate lens provide maximum protection
- Solid state design resists shock and vibration, IP67 weatherproof rating
- Easy installation. Fits OEM housing and plugs into existing headlight wiring harness. LED halo ring requires additional wiring installation

Item Number	Description	Package	Pack
31496	Dual Function LED Halo	Boxed	1 Pc./Box





7" LED Headlight W/ LED Position Light Bar

- High power LED headlight with LED position light bar
- Dual function headlight: low & high beam
- Aluminum housing with proprietary heat management provides maximum protection
- Solid state design resists shock and vibration
- Easy connection, fits OEM housing, plugs into existing wiring harness, position light requires additional wiring
- Super bright 2,000 lumen rated high beam output
- DOT/SAE approved

Item Number	Description	Package	Pack
31200	LED HL W/ LED Light Bar	Boxed	1 Pc./Box

7" LED Headlight W/ Turn Signal & Position Light Bar

- High power LED headlight w/ LED turn signal/position light bar
- Aluminum housing with proprietary heat management provides maximum protection for long-lasting performance
- Solid state design resists shock and vibration
- Easy connection, fits OEM housing, plugs into existing wiring harness
- LED position light requires additional wiring, pre-wired with 0.156" diameter male bullet plug
- Low beam rated at 900 lumens, 25 Watt, 5700K
- High beam rated at 1300 lumen, 25 Watt, 5700k

Item Number	Description	Package	Pack
31458	Amber LED Halo Ring	Boxed	1 Pc./Box
31459	White LED Halo Ring	Boxed	1 Pc./Box



7" LED Dual Function Headlight

- 5 high power LED 7" headlight, Philips LuminiLeds
- Reinforced aluminum reflector, rugged anti-vibration construction
- Improved visibility with whiter light output that is closer to the color temperature of daylight, IP67 rating
- Low beam 12-24V DC input, 1.7amp @ 12.8V DC, lumen output: 1020, FMVSS 108
- High beam 12-24V DC input, 2.6amp @ 12.8V DC, lumen output: 1600, FMVSS 108

Item Number	Description	Package	Pack
31289	LED Dual Function	Boxed	1 Pc./Box

LED LIGHTS
7" HEADLIGHTS

7" LED Dual Function Headlight - Chrome

- 5 high power LED 7" headlight, Philips LumiLEDs
- Reinforced aluminum reflector, rugged anti-vibration construction
- Improved visibility with whiter light output that is closer to the color temperature of daylight, IP67 rating
- Low beam 12-24V DC input, 1.7amp @ 12.8V DC, lumen output: 1020, FMVSS 108
- High beam 12-24V DC input, 2.6amp @ 12.8V DC, lumen output: 1600, FMVSS 108

Item Number	Description	Package	Pack
31391	5 High Power LED	Boxed	1 Pc./Box



7" LED Headlight W/ Daytime Running Light Bar

- High power 3 LED headlight with 10 LED daytime running light bar
- 3 high power 7W LED for exceptional performance
- 900 lumens output on low and 1,600 lumens output on high
- White position light bar can be wired as daytime running light, amber position light bar can be wired as turn signal
- Easy installation, fits OEM housing, plugs into existing wiring harness
- Low beam application: 900 lumens, 9V-33V DC input, FMVSS 108
- High beam application: 1600 lumens, 9V-33V DC input, FMVSS 108

Item Number	Description	Package	Pack
31513	White LED Light Bar	Boxed	1 Pc./Box
31514	Amber LED Light Bar	Boxed	1 Pc./Box

7" LED Crystal Headlight - Chrome or Blackout

- 11 high power LED 7" crystal headlight, 1 single low beam center LED (green wire), 10 outer high beam LED (red wire)
- Solid state design resists shock and vibration
- Impact resistant polycarbonate lens provides protection
- Improved visibility with whiter light output that is closer to daylight
- Die-cast aluminum housing provides maximum protection
- Load resistor may be required for proper installation

Item Number	Description	Package	Pack
31355	Chrome Housing	Boxed	1 Pc./Box
31353	Blackout Housing	Boxed	1 Pc./Box





7" 24 LED Headlight W/ Dual Color Position Light

- 24 LED high power 7" light with 8 dual color LED position light
- LED white/amber position light bar changes from white to amber when sequential light is activated
- Sequential amber position light can be connected for left-hand or right-hand operation
- High beam 5,000 lumens, low beam 2,000 lumens, position light white, 200 lumens, position light amber 125 lumens
- Some OE light housing may require modification to fit
- 12VDC - 24VDC, IP67 water resistant rating

Item Number	Description	Package	Pack
36452	24 LED Headlight	Boxed	1 Pc./Box



7" LED Headlight W/ LED Halo Ring

- Durable corrosion resistant polycarbonate lens & housing
- Solid state design resists shock and vibration
- Easy installation, fits OEM housing, plugs into existing wiring harness
- Low beam 500 lumens, 5700kelvin, 12-24V DC input
- High beam 950 lumens, 5700kelvin, 12-24V DC input

Item Number	Description	Package	Pack
31084	Amber LED Halo Ring	Boxed	1 Pc./Box



7" Crystal Headlight W/ LED Halo Ring

- 7" crystal headlight with amber LED halo ring and 9007 bulb
- Reinforced multi-surfaced, aluminum reflector
- Features bright LED halo ring and standard 9007 bulb

Item Number	Description	Package	Pack
31284	Amber LED Halo Ring	Boxed	1 Pc./Box
31285	White LED Halo Ring	Boxed	1 Pc./Box



LED LIGHTS
7" HEADLIGHTS

7" Crystal Headlight W/ 34 LED Position Light

- Reinforced multi-surfaced, aluminum reflector
- Aluminum reflector, anti-vibration structural design
- Features 34 white LED position lights
- H4/HB2/9003 halogen bulb: 12V 65/55W, replaces H6017/H6024

Item Number	Description	Package	Pack
31378	Amber LED Halo Ring	Boxed	1 Pc./Box
31379	White LED Halo Ring	Boxed	1 Pc./Box



7" Crystal Headlight W/ 6 Amber LED Position Light

- Super quality with reinforced multi-surfaced, aluminum reflector
- 6 amber Hi/Low function LED
- Rugged anti-vibration construction
- Includes 9007 halogen bulb and seal beam/H4 plug adapter
- LED for auxiliary/utility purposes
- 12V, dual function auxiliary LED with three wire hookup

Item Number	Description	Package	Pack
31247	Amber LED Halo Ring	Boxed	1 Pc./Box

7" Halogen Crystal Headlight W/ 10 LED Position Lights

- Reinforced multi-faceted, aluminum reflector, anti-vibration design
- Halogen bulb: HB2/9003 12V 65/55W, replaces H6017/H6024
- Reinforced aluminum reflector w/ rugged anti-vibration construction
- LED portion of the light for auxiliary/utility purposes
- Simple 3 wire hookups, white=ground, black=12V & function #1, red= 12V & function # 2

Item Number	Description	Package	Pack
S2010LED	10 Amber LED Position Lt.	Boxed	1 Pc./Box





5 3/4" LED Headlight W/ Position Light

- 9 high power 5 3/4" LED headlight with LED position light bar
- High power bright LED high and low beam
- Reinforced aluminum reflector w/ rugged anti-vibration construction

Item Number	Description	Package	Pack
31259	9 Amber LED Position Lt.	Boxed	1 Pc./Box
31267	9 White LED Position Lt.	Boxed	1 Pc./Box

5 3/4" LED Headlight - Silver or Black

- 8 high power 5 3/4" LED headlight
- Replaces H5001 bulb, DOT/SAE and FMVSS 108 compliant
- Easy connection, fits OEM housing, plugs into existing wiring harness
- Low beam 1,020 lumens, high beam 1,600 lumens

Item Number	Description	Package	Pack
31201	Silver Housing	Boxed	1 Pc./Box
31202	Black Housing	Boxed	1 Pc./Box



5 3/4" Crystal Halogen Headlight W/ 5 LED Position Light

- Flat crystal clear glass lens with chrome metal reflector
- 5 amber LED have high/low function, 12V
- 60/55 Watt H4 inner head light bulb is replaceable part # 30355
- Advance multi-faceted surface helps you see further

Item Number	Description	Package	Pack
S2005LED	5 Amber LED Position Lt.	Boxed	1 Pc./Box



LED LIGHTS
7" GUIDE STYLE HEADLIGHTS





Classic Headlight H4 Bulb W/ 6 Amber LED

- Beautiful high quality stainless steel or chrome plated headlight with crystal headlight bulb and 6 amber Hi/Low function LEDs
- LEDs for auxiliary/utility purpose
- Headlight available separately item # 31247, stainless housing # 30368, chrome housing # 30375
- 12V, dual function auxiliary LEDs have three wire hookup

Item Number	Description	Package	Pack
32508	Stainless Steel/Amber LED	Boxed	1 Pc./Box
32509	Chrome/Amber LED	Boxed	1 Pc./Box

Guide 682-C Style Headlight H4 W/ 10 Amber LED Signal

- Beautiful chrome plated or gloss black housing with chrome plated bezel
- Fully assembled with crystal clear halogen bulb with amber LED accent lights, item # S2010LED
- Includes top mounted dual function signal light with 5 amber LED and clear lens

Item Number	Description	Package	Pack
32043	10 Amber LED/Chrome	Boxed	1 Pc./Box
32047	10 Amber LED/Black	Boxed	1 Pc./Box



Guide 682-C Style Headlight H4 Bulb W/ 10 Amber LED

- Beautiful gloss black or chrome plated housing with chrome plated bezel and 10 amber LED accent light
- Fully assembled with crystal halogen bulb with amber LED accent lights, item # S2010LED
- Ready to use, can also be painted to match your vehicle
- Included housing can be purchased separately, item # 32018

Item Number	Description	Package	Pack
32655	10 Amber LED/Black	Boxed	1 Pc./Box
32035	10 Amber LED/Chrome	Boxed	1 Pc./Box



Bracket Sold Separately

7" GUIDE HEADLIGHTS

Chrome Guide 682-C Style Headlight H4 W/ LED Signal

- Beautiful chrome plated headlight housing and bezel
- Fully assembled with crystal clear lens halogen headlight
- Headlight features 34 bright white or amber LED position light
- Includes top mount 5 amber LED w/ clear lens light, # 38029B
- Included housing can be purchased separately, item # 32007

Item Number	Description	Package	Pack
32441	34 White LED	Boxed	1 Pc./Box
32429	34 Amber LED	Boxed	1 Pc./Box



Stainless Guide 682-C Style Headlight H4 W/ LED Signal

- Stainless steel guide 682-C headlight H4 with 34 LEDs and LED position light
- Fully assembled with crystal clear lens halogen headlight, #31379
- Headlight features 34 bright white or amber LED position light
- Includes top mount 5 amber LED w/ clear lens light, # 38029B
- Included housing can be purchased separately, item # 32005

Item Number	Description	Package	Pack
32437	34 White LED	Boxed	1 Pc./Box
32425	34 Amber LED	Boxed	1 Pc./Box

Guide 682-C Style Headlight H4 Bulb W/ 6 Amber LED

- Crystal headlight bulb with Amber Hi/Low function LED
- LEDs for auxiliary/utility purposes
- 12V, dual function auxiliary LEDs have three wire hookup
- Headlight item# 31247, stainless housing # 32006, chrome housing # 32008, black housing # 32009

Item Number	Description	Package	Pack
32557	Stainless Steel/Amber LED	Boxed	1 Pc./Box
32558	Chrome Guide/Amber LED	Boxed	1 Pc./Box
32559	Black Guide/Amber LED	Boxed	1 Pc./Box





Bracket Sold Separately

Classic Half Moon Headlight H4 W/ LED Turn Signal

- Highly polished 304 stainless steel headlight housing "Classic" style bezel
- Fully assembled with crystal halogen bulb with amber LED accent lights, item # S2010LED
- Includes 4 amber LED with amber lens, turn signal lens #38505B
- Included housing can be purchased separately, item # 30470-1

Item Number	Description	Package	Pack
32059	4 Amber LED Turn Signal	Boxed	1 Pc./Box

Classic Half Moon Headlight 11 LED & LED Turn Signal

- Highly polished 304 stainless steel headlight housing and "Classic" style bezel
- Highly polished stainless steel finish for durability and shine
- Headlight features 11 bright LEDs and 4 amber LED turn signal

Item Number	Housing	Lens	LED	Package	Pack
31570	Stainless	Amber	Amber	Boxed	1 Pc./Box
31571	Stainless	Clear	Amber	Boxed	1 Pc./Box



Black Guide Headlight 11 LED Bulb

- Gloss black powder coated steel headlight housing and beautiful chrome plated bezel and housing
- Fully assembled with LED headlight with crystal clear lens
- Single high power low beam LED and 10 outer LED w/ black housing
- Included housing can be purchased separately, item # 32018

Item Number	Description	Package	Pack
32658	11 LED/Blackout	Boxed	1 Pc./Box
32659	11 LED/Chrome	Boxed	1 Pc./Box

7" GUIDE HEADLIGHTS

Bullet Classic Embossed Stripe 11 LED Crystal Headlight

- 7" stainless steel classic embossed stripe headlight with 11 LED crystal halogen
- Classic look with 3 raised ribs
- Universal ball mount fits any application
- 304 high grade stainless steel, rust free

Item Number	Description	Package	Pack
32763	11 White LED	Boxed	1 Pc./Box
32771	11 White LED	Boxed	1 Pc./Box



Bullet Classic Headlight W/ 6 Amber LED Signal

- Highly polished 304 stainless steel headlight housing and "Bullet" style bezel
- Fully assembled with crystal clear lens halogen headlight
- Headlight features 34 bright white LED position light
- Includes 4 amber LED turn signal light single function

Item Number	Housing	Lens	LED	Package	Pack
32468	Stainless	Amber	Amber	Boxed	1 Pc./Box
32469	Stainless	Clear	Amber	Boxed	1 Pc./Box

Bullet Half Moon Headlight W/ 6 Amber LED Signal

- Highly polished 304 stainless steel headlight housing and "Bullet" style bezel
- Fully assembled with crystal clear lens halogen headlight
- Headlight features 34 bright white LED position light
- Includes 4 amber LED turn signal light single function

Item Number	Housing	Lens	LED	Package	Pack
32452	Stainless	Amber	Amber	Boxed	1 Pc./Box
32453	Stainless	Clear	Amber	Boxed	1 Pc./Box





Bullet Classic Headlight H4 W/ Amber LED & Signal

- Highly polished 304 stainless steel headlight housing and "Bullet" style bezel
- Fully assembled with crystal clear lens LED headlight
- Headlight features 34 bright amber LED position light
- Includes 4 amber LED turn signal light

Item Number	Housing	Lens	LED	Package	Pack
32464	Stainless	Amber	Amber	Boxed	1 Pc./Box
32465	Stainless	Clear	Amber	Boxed	1 Pc./Box

Classic Half Moon Headlight H4 W/ Amber LED & Signal

- Highly polished 304 stainless steel headlight housing and "Classic" style bezel
- Fully assembled with crystal clear lens LED headlight
- Headlight features 34 bright amber LED position light
- Includes 4 amber LED turn signal light

Item Number	Housing	Lens	LED	Package	Pack
32456	Stainless	Amber	Amber	Boxed	1 Pc./Box
32457	Stainless	Clear	Amber	Boxed	1 Pc./Box



Classic Headlight H4 W/ 34 Amber LED & LED Turn Signal

- Beautiful chrome plated housing and bezel
- Fully assembled with crystal clear lens LED headlight, item #31378
- Headlight features 34 bright amber LED position light
- Includes 4 amber LED turn signal light

Item Number	Description	Package	Pack
32480	Amber LED/Amber Lens	Boxed	1 Pc./Box
32481	Amber LED/Clear Lens	Boxed	1 Pc./Box



7" GUIDE HEADLIGHTS

Classic Headlight Crystal H4 W/ LED Turn Signal

- Beautiful chrome plated or highly polished 304 stainless steel headlight housing and "Classic" style bezel
- Fully assembled with H4 halogen bulb and 4 amber LED turn signal
- High quality chrome or stainless steel finish for durability and shine

Item Number	Housing	Lens	LED	Package	Pack
31773	Chrome	Amber	Amber	Boxed	1 Pc./Box
31758	Stainless	Amber	Amber	Boxed	1 Pc./Box



Bullet Embossed Stripe Headlight W/ 34 White LED

- Stainless steel classic embossed stripe headlight with 34 LED crystal halogen
- Classic look with 3 raised ribs
- Universal ball mount fits any application
- 304 high grade stainless steel, rust free

Item Number	Description	Package	Pack
32766	34 Amber LED	Boxed	1 Pc./Box
32767	34 White LED	Boxed	1 Pc./Box

Bullet Embossed Stripe Headlight W/ 34 Amber LED

- Stainless steel bullet embossed stripe headlight with 34 amber LED crystal halogen
- Classic look with 3 raised ribs
- Distinctive sharp edge "bullet" style rim
- Universal ball mount fits any application
- 304 high grade stainless steel, rust free

Item Number	Description	Package	Pack
32774	34 Amber LED	Boxed	1 Pc./Box
32775	34 White LED	Boxed	1 Pc./Box





Classic Embossed Stripe Headlight

- 7" round stainless steel classic embossed stripe headlight w/ 5 LED
- Classic look with 3 raised ribs
- Universal ball mount fits any application
- 304 high grade stainless steel, rust free

Item Number	Description	Package	Pack
32762	5 LED	Boxed	1 Pc./Box
32770	5 LED	Boxed	1 Pc./Box

Classic Embossed Stripe Headlight W/ 6 Amber LED

- Stainless steel classic embossed stripe headlight w/ 6 amber LED crystal halogen
- Classic look with 3 raised ribs
- Universal ball mount fits any application
- 304 high grade stainless steel, rust free

Item Number	Description	Package	Pack
32769	6 Amber LED	Boxed	1 Pc./Box



Bullet Embossed Stripe Headlight W/ 6 Amber LED

- Stainless steel bullet embossed stripe headlight w/ 6 amber LED crystal halogen
- Classic look with 3 raised ribs
- Universal ball mount fits any application
- 304 high grade stainless steel, rust free

Item Number	Description	Package	Pack
32777	6 Amber LED	Boxed	1 Pc./Box



7" GUIDE HEADLIGHTS

Bullet Embossed Stripe Headlight W/ 6 Amber LED

- Stainless steel bullet embossed stripe headlight w/ 6 amber LED & dual mode LED signal
- Classic look with 3 raised ribs
- Universal ball mount fits any application
- 304 high grade stainless steel, rust free

Item Number	Description	Package	Pack
32760	6 Amber LED/Amber Lens	Boxed	1 Pc./Box
32761	6 Amber LED/Clear Lens	Boxed	1 Pc./Box



Classic Embossed Stripe Headlight W/ 6 Amber LED

- Stainless steel classic embossed stripe headlight w/ 6 amber LED & dual mode LED signal
- Classic look with 3 raised ribs
- Dual function LED turn signal light built into top of rim
- Universal ball mount fits any application
- 304 high grade stainless steel, rust free

Item Number	Description	Package	Pack
32744	6 Amber LED/Amber Lens	Boxed	1 Pc./Box
32745	6 Amber LED/Clear Lens	Boxed	1 Pc./Box



Dietz Style Headlight H4 Bulb W/ 6 Amber LED

- Chrome complete assembly
- Crystal headlight bulb with amber hi/low function LEDs
- LED for auxiliary/utility purposes
- 12V, dual function auxiliary LED have three wire hookup

Item Number	Description	Package	Pack
32695	Chrome/6 Amber LED	Boxed	1 Pc./Box



Chrome Dietz Style Headlight H4 Bulb W/ 6 Amber LED

- Stainless steel complete assembly
- Crystal headlight bulb with amber hi/low function LEDs
- LED for auxiliary/utility purposes
- 12V, dual function auxiliary LED have three wire hookup

Item Number	Description	Package	Pack
32696	Stainless/6 Amber LED	Boxed	1 Pc./Box



Dietz Style Headlight W/ 10 LED Headlamp Bulb

- Gloss black powder coated or highly polished 304 stainless steel "Dietz" style headlight with crystal lens and 10 LED headlamp bulb
- Single high power low beam LED and 10 outer LEDs
- For street rods and 1928-34 Ford cars and trucks

Item Number	Description	Package	Pack
A5022BCL	Black/Stainless	Boxed	1 Pc./Box
A5022SSE	Stainless Steel	Boxed	1 Pc./Box





Chopper Headlight W/ Smooth Visor W/ 34 LED

- Chrome aluminum billet style housing with smooth visor to give that ultra slick look
- Same billet style headlight found on custom motorcycles/choppers
- Fully assembled w/ crystal clear lens and 34 bright LED position light
- Included housing can be purchased separately, item # 32181

Item Number	Description	Package	Pack
32519	34 Amber LED	Boxed	1 Pc./Box
32520	34 White LED	Boxed	1 Pc./Box

Chopper Headlight W/ Smooth Visor H4 Bulb W/ 34 LED

- Ultra slick looking billet style chrome plated aluminum housing with smooth visor
- Fully assembled with crystal clear lens LED headlight, item # 31378
- Headlight features 34 bright LED position light
- Included housing can be purchased separately, item # 32181

Item Number	Description	Package	Pack
32511	34 Amber LED Position Lt.	Boxed	1 Pc./Box
32512	34 White LED Position Lt.	Boxed	1 Pc./Box



Chopper Headlight H4 Bulb W/ 34 LED

- Chrome aluminum billet style housing to give that ultra slick look
- Same billet style headlight found on custom motorcycles/choppers
- Fully assembled w/ crystal clear lens and 34 bright LED position light
- Included housing can be purchased separately, item # 32185

Item Number	Description	Package	Pack
32553	34 Amber LED	Boxed	1 Pc./Box
32554	34 White LED	Boxed	1 Pc./Box



Chopper Headlight W/ Razor Visor, 34 LED

- Chrome aluminum billet style housing with razor style visor to give that ultra slick look
- Same billet style headlight found on custom motorcycles/choppers
- Fully assembled w/ crystal clear lens and 34 bright LED position light
- Included housing can be purchased separately, item # 32182

Item Number	Description	Package	Pack
32527	34 Amber LED	Boxed	1 Pc./Box
32528	34 White LED	Boxed	1 Pc./Box



7" GUIDE HEADLIGHTS

Billet Style Groove Headlight W/H4 Bulb

- Black "Billet" style groove headlight with H4 bulb and 34 LED position light
- Fully assembled with crystal clear lens LED headlight, item # 31379
- Headlight features 34 bright LED position light
- Included housing can be purchased separately, item # 31498

Item Number	Description	Package	Pack
32668	34 Amber LED Position Lt.	Boxed	1 Pc./Box



Billet Style Groove Headlight W/ Visor H4 Bulb

- Black "Billet" style groove headlight with visor, H4 bulb and 34 amber or white LED position light
- Fully assembled with crystal clear lens LED headlight, item # 31379
- Headlight features 34 bright LED position light
- Included housing can be purchased separately, item # 31498

Item Number	Description	Package	Pack
32681	34 Amber LED Position Lt.	Boxed	1 Pc./Box
32682	34 White LED Position Lt.	Boxed	1 Pc./Box

Billet Style Groove Headlight W/ Visor 5 LED Bulb

- Gloss black powder coated "Billet" style headlight housing
- Fully assembled with dual function LED headlight, item # 31391
- LED headlight features dual Hi/Lo function, chrome accent center bar and crystal clear lens
- Included housing can be purchased separately, item # 31497

Item Number	Description	Package	Pack
32677	5 LED Dual Function	Boxed	1 Pc./Box



LED LIGHTS
7" GUIDE HEADLIGHTS



Billet Style Groove Headlight W/ Visor 5 LED Bulb

- Gloss black powder coated "Billet" style headlight housing
- Fully assembled with dual function LED headlight, item # 31391
- LED headlight features dual Hi/Lo function, chrome accent center bar and crystal clear lens
- Included housing can be purchased separately, item # 31498

Item Number	Description	Package	Pack
32691	5 LED Dual Function	Boxed	1 Pc./Box

Billet Style Groove Headlight W/ LED Halo Rim

- Gloss black powder coated "Billet" style groove headlight 9007 bulb with white LED halo rim
- Included housing can be purchased separately, item # 31497

Item Number	Description	Package	Pack
32670	LED Halo Rim	Boxed	1 Pc./Box



Billet Style Groove Headlight W/ Visor Halo LED

- Black "Billet" style groove headlight with visor, 9007 bulb and LED halo rim
- Housing item # 31498 light bulb item # 31285
- Included housing can be purchased separately, item # 31497

Item Number	Description	Package	Pack
32683	Amber LED Halo	Boxed	1 Pc./Box
32684	White LED Halo	Boxed	1 Pc./Box



LED LIGHTS
7" GUIDE HEADLIGHTS

Billet Style Groove Headlight 5 LED Bulb

- Gloss black powder coated "Billet" style headlight housing
- Fully assembled with dual function LED headlight, item # 31381
- LED headlight features dual Hi/Lo function, black accent center bar and crystal clear lens
- Included housing can be purchased separately, item # 31497

Item Number	Description	Package	Pack
32676	5 LED Dual Function	Boxed	1 Pc./Box



Billet Style Groove Headlight W / Visor 5 LED Bulb

- Gloss black powder coated "Billet" style headlight housing
- Fully assembled with dual function LED headlight, item # 31389
- LED headlight features dual Hi/Lo function, black accent center bar and crystal clear lens
- Included housing can be purchased separately, item # 31498

Item Number	Description	Package	Pack
32690	5 LED Dual Function	Boxed	1 Pc./Box



Billet Style Groove Headlight W/ 11 LED

- Gloss black powder coated "Billet" style headlight housing
- Single high power low beam LED and 10 outer LEDs
- Included housing can be purchased separately, item # 31497

Item Number	Description	Package	Pack
32674	11 LED/Black	Boxed	1 Pc./Box
32675	11 LED/Chrome	Boxed	1 Pc./Box

Billet Style Groove Headlight W/ Visor 11 LED

- Gloss black powder coated "Billet" style headlight housing
- Single high power low beam LED and 10 outer LEDs
- Included housing can be purchased separately, item # 31497

Item Number	Description	Package	Pack
32688	11 LED/Black	Boxed	1 Pc./Box
32689	11 LED/Chrome	Boxed	1 Pc./Box



No Visor



Chopper Style Headlight W/ 11 LED Bulb

- Ultra slick looking "Billet" style chrome plated aluminum housing
- Fully assembled LED headlight with crystal clear lens, item #31355
- LED headlight features single high power low beam 10 outer LED with chrome housing
- Included housing can be purchased separately, item # 32185

Item Number	Description	Package	Pack
31584	11 LED/Chrome	Boxed	1 Pc./Box

7" GUIDE HEADLIGHTS

Classic Headlight 11 LED W/ LED Turn Signal

- Highly polished 304 stainless steel headlight housing and "Bullet" style bezel
- Fully assembled with crystal clear lens LED headlight
- Headlight features 11 bright LEDs
- Includes 4 amber or white LED turn signal light

Item Number	Description	Package	Pack
31574	Amber LED Turn Signal	Boxed	1 Pc./Box
31575	White LED Turn Signal	Boxed	1 Pc./Box



Classic Headlight H4 W/ Amber LED Turn Signal

- Beautiful chrome plated or stainless steel headlight housing and "Classic" style bezel
- Fully assembled with H4 halogen bulb and 4 amber LED turn signal
- High quality chrome or stainless steel finish for durability and shine

Item Number	Housing	Lens	LED	Package	Pack
31770	Chrome	Amber	Amber	Boxed	1 Pc./Box
31771	Chrome	Clear	Amber	Boxed	1 Pc./Box
31755	Stainless	Amber	Amber	Boxed	1 Pc./Box

Classic Headlight 6014 Bulb & LED Turn Signal

- Highly polished 304 stainless steel headlight housing and "Bullet" style bezel
- Fully assembled headlight with H6014 halogen seal beam bulb
- Includes 4 amber LEDs with amber or clear lens

Item Number	Housing	Lens	LED	Package	Pack
31704	Stainless	Amber	Amber	Boxed	1 Pc./Box
31705	Stainless	Clear	Amber	Boxed	1 Pc./Box





Bullet Classic Headlight H6024 LED Turn Signal

- Highly polished 304 stainless steel headlight housing and "Bullet" style bezel
- Fully assembled headlight with H4 halogen bulb
- Includes 4 amber LED turn signal with amber or clear lens

Item Number	Housing	Lens	LED	Package	Pack
31740	Stainless	Amber	Amber	Boxed	1 Pc./Box
31741	Stainless	Clear	Amber	Boxed	1 Pc./Box

Bullet Classic Headlight H6024 LED Turn Signal

- Highly polished 304 stainless steel headlight housing and "Bullet" style bezel
- Fully assembled headlight with H6024 halogen bulb
- Includes 4 amber LEDs with amber or clear lens

Item Number	Housing	Lens	LED	Package	Pack
31737	Stainless	Amber	Amber	Boxed	1 Pc./Box
31738	Stainless	Clear	Amber	Boxed	1 Pc./Box



Bullet Classic Headlight H6014 & LED Turn Signal

- Highly polished 304 stainless steel headlight housing and "Bullet" style bezel
- Fully assembled headlight with H6014 halogen seal beam bulb
- Includes 4 amber LED turn signal with amber or clear lens

Item Number	Housing	Lens	LED	Package	Pack
31734	Stainless	Amber	Amber	Boxed	1 Pc./Box
31735	Stainless	Clear	Amber	Boxed	1 Pc./Box



7" GUIDE HEADLIGHTS

Classic Half Moon Headlight H4 Bulb & LED Turn Signal

- Highly polished 304 stainless steel headlight housing and "Classic" style bezel
- Fully assembled headlight with H4 halogen bulb
- Includes 4 amber LEDs with amber or clear lens turn signal

Item Number	Housing	Lens	LED	Package	Pack
31725	Stainless	Amber	Amber	Boxed	1 Pc./Box
31726	Stainless	Clear	Amber	Boxed	1 Pc./Box



Bullet Half Moon Headlight H4 Bulb & LED Turn Signal

- Highly polished 304 stainless steel headlight housing and "Bullet" style bezel
- Fully assembled headlight with H4 halogen bulb
- Includes 4 amber LEDs with amber or clear lens turn signal

Item Number	Housing	Lens	LED	Package	Pack
31710	Stainless	Amber	Amber	Boxed	1 Pc./Box
31711	Stainless	Clear	Amber	Boxed	1 Pc./Box

Bullet Half Moon Headlight H6024 Bulb & LED Turn Signal

- Highly polished 304 stainless steel headlight housing and "Bullet" style bezel
- Fully assembled headlight with H6024 halogen bulb
- Includes 4 amber LEDs with amber lens turn signal

Item Number	Housing	Lens	LED	Package	Pack
31707	Stainless	Amber	Amber	Boxed	1 Pc./Box





Guide Headlight With 5 LED bulb

- Gloss black powder coated steel headlight and beautiful chrome plated bezel
- Fully assembled with dual function LED headlight, item # 31289
- LED headlight features dual Hi/Lo function, black or chrome accent center bar and crystal clear lens
- Ready to use, can also be painted to match your vehicle
- Included housing can be purchased separately, item # 32018

Item Number	Description	Package	Pack
32660	Black Accent	Boxed	1 Pc./Box
32661	Chrome Accent	Boxed	1 Pc./Box

Guide Headlight 9007 Bulb With LED Halo Rim

- Gloss black powder coated steel headlight housing and beautiful chrome plated bezel
- Headlight features bright amber or white LED position light
- Gloss black ready to use, can also be painted to match your vehicle
- Housing item # 32018, light bulb item # 31284
- 304 high grade stainless steel, rust free

Item Number	Description	Package	Pack
32662	Amber LED Halo	Boxed	1 Pc./Box
32663	White LED Halo	Boxed	1 Pc./Box



Guide 682-C Headlight H4 Bulb W/ 34 LED

- Gloss black powder coated steel headlight housing and beautiful chrome plated bezel
- Fully assembled with crystal clear lens LED headlight
- Headlight features 34 bright amber or white LED position light
- Ready to use, can also be painted to match your vehicle
- Included housing can be purchased separately, item # 32018

Item Number	Description	Package	Pack
32653	34 Amber LED Position Lt.	Boxed	1 Pc./Box
32654	34 White LED Position Lt.	Boxed	1 Pc./Box



7" GUIDE HEADLIGHTS

Classic Headlight H6024 Bulb & Amber LED Turn Signal

- Beautiful chrome plated headlight housing and "Classic" style bezel
- Fully assembled w/ H6024 halogen bulb and 4 amber LED turn signal
- High quality chrome or stainless steel finish for durability and shine

Item Number	Housing	Lens	LED	Package	Pack
31767	Chrome	Amber	Amber	Boxed	1 Pc./Box
31768	Chrome	Clear	Amber	Boxed	1 Pc./Box



Classic Headlight H6024 Bulb & Amber LED Turn Signal

- Beautiful stainless steel headlight housing and "Classic" style bezel
- Fully assembled w/ H6024 halogen bulb and 4 amber LED turn signal
- High quality chrome or stainless steel finish for durability and shine

Item Number	Housing	Lens	LED	Package	Pack
31752	Stainless	Amber	Amber	Boxed	1 Pc./Box
31753	Stainless	Clear	Amber	Boxed	1 Pc./Box

Black Guide 682-C Style Headlight H6024 & LED Signal

- Gloss black powder coated steel headlight with matching top mount cover and beautiful chrome plated bezel
- Fully assembled with H6024 halogen bulb, item # 30356
- Includes top mount 5 amber LED with clear lens item # 38029B
- Included housing can be purchased separately, item # 32009

Item Number	Description	Package	Pack
31555	5 LED Turn Signal	Boxed	1 Pc./Box



Black Guide 682-C Headlight & Original Style LED Signal

- Gloss black powder coated steel headlight w/ matching top mount cover and beautiful chrome plated bezel
- Fully assembled with H4 halogen bulb, item # A5023-3
- Features top mounted amber LED with clear lens signal light
- Ready to use, can also be painted to match your vehicle

Item Number	Description	Package	Pack
32639	Black Guide 682-C	Boxed	1 Pc./Box

5"x7" RECTANGULAR HEADLIGHTS



"5x7" LED Headlight W/ LED Light Bar

- 9 high power LED rectangular headlight w/ 6 white LED light bar
- Reinforced aluminum reflector, rugged anti-vibration construction
- IP67 weatherproof rating
- High beam 3,700 lumens, low beam 1,800 lumens

Item Number	Description	Package	Pack
34122	6 White LED Light Bar	Boxed	1 Pc./Box

"5x7" LED Headlight W/ Polycarbonate Lens & Housing

- 12 high power LED rectangular headlight with durable corrosion resistant polycarbonate lens & housing
- Solid state design resists shock and vibration
- Easy connection, fits OEM housing, plugs into existing wiring harness, position light requires additional wiring
- High beam 1,100 lumens, low beam 600 lumens

Item Number	Description	Package	Pack
31087	12 High Power LED	Boxed	1 Pc./Box



"5x7" LED Crystal Headlight

- 5 high power LED crystal headlight w/ high and low beam function
- Reinforced aluminum reflector rugged anti-vibration construction
- Easy connection, fits OEM housing, plugs into existing wiring harness, position light requires additional wiring
- High beam 1,100 lumens, low beam 600 lumens

Item Number	Description	Package	Pack
31297	5 High Power LED	Boxed	1 Pc./Box



4"x6" RECTANGULAR HEADLIGHTS**"5x7" 7 LED Headlight W/ LED Light Bar**

- 7 high power LED headlight with 3 LED position light bar
- High and low beam function
- Reinforced aluminum reflector
- Easy connection, fits OEM housing, plugs into existing wiring harness, position light requires additional wiring
- IP 66 rated, DOT/SAE approved
- High beam 1,680 lumens, 12V-24V DC input, 1.15 amps
- Low beam 2,850 lumens, 12V-24V DC input, 2.7 amps

Item Number	Description	Package	Pack
31120	7 High Power LED	Boxed	1 Pc./Box

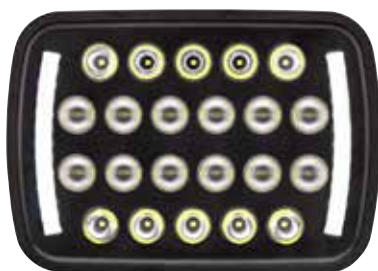
**5"x7" 22 High Power LED Headlight W/ LED Position Light**

- LED dual function black rectangular headlight with 12 white LED position lights
- Ultra slim housing design for easy installation
- Rugged anti-vibration construction
- Easy connection, fits OEM housing or fender, plugs into existing wiring harness, position light requires additional wiring
- High beam, 4,000 lumens, low beam 2,000 lumens, position light 100 lumens, 12VDC-24VDC

Item Number	Description	Package	Pack
36450	22 LED Headlight-Black	Boxed	1 Pc./Box

4"x6" 18 High Power LED Headlight W/ LED Position Lt.

- 18 high power LED headlight w/ 10 white LED position lights
- Ultra slim housing design for easier installation
- Rugged anti-vibration construction
- Easy connection, fits OEM housing, plugs into existing wiring harness, position light requires additional wiring
- High beam 3,500 lumens, 6500k, low beam 1,500 lumens/6500k position light 100 lumens, 12VDC-24VDC
- IP67 water resistant rating

Item Number	Description	Package	Pack
36449	18 LED Headlight	Boxed	1 Pc./Box

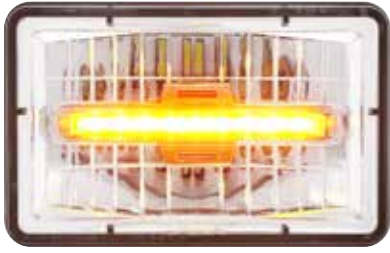

**4"x6" LED Headlight W/ Amber Auxiliary Light**

- High power LED headlight w/ quality crystal clear polycarbonate lens
- 9 super bright amber LED center light bar
- Waterproof housing provides maximum protection & durability
- OEM fit, plugs into existing wiring harness
- Sold individually, please specify low beam or high

Item Number	Description	Package	Pack
31150	Low Beam	Boxed	1 Pc./Box
31151	High Beam	Boxed	1 Pc./Box

4"x6" LED Headlight W/ White Auxiliary Light

- High power LED headlight with quality crystal clear polycarbonate lens
- 9 super bright white LED center light bar
- Waterproof die-cast housing provides maximum protection & durability
- OEM fit, plugs into existing wiring harness
- Sold individually, please specify low beam or high

Item Number	Description	Package	Pack
31152	Low Beam	Boxed	1 Pc./Box
31153	High Beam	Boxed	1 Pc./Box

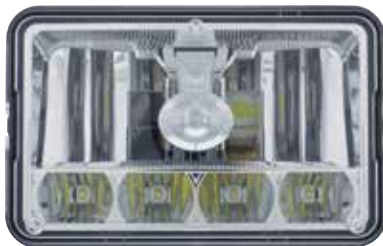
**4"x6" LED Crystal Headlight**

- High power 5 LED crystal headlight w/ high and low beam function
- Reinforced aluminum reflector, rugged anti-vibration construction
- Replaces H4651/H4656
- SAE approved

Item Number	Description	Package	Pack
31365	Low Beam	Boxed	1 Pc./Box

4"x6" RECTANGULAR HEADLIGHTS**4"x6" LED Headlight W/ White LED Position Light**

- 1 high power LED headlight w/ dual function 6 amber LED position light and polycarbonate lens
- Solid state design resists shock and vibration
- Die-cast aluminum housing provides maximum protection
- Load resistor may be required for proper installation, item #34205
- For offroad use only, 3 year warranty
- Application 12-24V DC input: 0.35 Amps/8.5 Watt

Item Number	Description	Package	Pack
31168	Low Beam	Boxed	1 Pc./Box
31169	High Beam	Boxed	1 Pc./Box

**4"x6" LED Headlight W/ Amber LED Position Light**

- 1 high power LED headlight w/ dual function 6 amber LED position light and polycarbonate lens
- Solid state design resists shock and vibration
- Die-cast aluminum housing provides maximum protection
- Load resistor may be required for proper installation, item #34205
- For offroad use only, 3 year warranty
- Application 12-24V DC input: 0.35 Amps/8.5 Watt

Item Number	Description	Package	Pack
31237	Low Beam	Boxed	1 Pc./Box
31238	High Beam	Boxed	1 Pc./Box



4"x6" RECTANGULAR HEADLIGHTS



4"x6" LED Headlight

- 5 high power LED headlight w/ polycarbonate lens & housing
- Solid state design resists shock and vibration
- Easy connection, fits OEM housing, plugs into existing wiring harness, position light requires additional wiring
- High beam 1000 lumens, 6500kelvin, color temp. 12-24V DC input
- DOT/SAE FMVSS 108

Item Number	Description	Package	Pack
31089	High Beam	Boxed	1 Pc./Box
31088	Low Beam	Boxed	1 Pc./Box

4"x6" Crystal Projection Headlight W/ LED Position Light

- Crystal projection headlight w/ 6 white LED position light
- Reinforced aluminum reflector, rugged anti-vibration construction
- Sylvania halogen bulb: DOT 9005 X/S 12V 60W, replaces H4656
- Includes two 9005 adapter plugs (one 3 wire to 2 wire plug and one 2 wire plug)

Item Number	Description	Package	Pack
31375	Low Beam	Boxed	1 Pc./Box
31376	High Beam	Boxed	1 Pc./Box



4"x6" 11 High Power LED Projection Headlight

- 11 high power LED projection headlight with white LED position light
- Improved visibility with light output that is closer to the color temperature of daylight
- Die-cast aluminum housing provides maximum protection
- Solid state design resists shock and vibration
- DOT/SAE and FMVSS 108

Item Number	Description	Package	Pack
31274	Low Beam	Boxed	1 Pc./Box
31275	High Beam	Boxed	1 Pc./Box



4"x6" RECTANGULAR HEADLIGHTS

4"x6" 9 High Power LED Headlight W/ LED Light Bar

- 9 super bright LED dual function headlight w/ 6 white LED light bar
- Die-cast aluminum housing provides maximum protection
- Headlight fits OEM housing, plugs into existing wiring harness
- For offroad use only

Item Number	Description	Package	Pack
34125	Low Beam	Boxed	1 Pc./Box



4"x6" 1 High Power CREE LED Headlight

- Improved visibility with light output that is closer to the color temperature of daylight
- Die-cast aluminum housing provides maximum protection
- Load resistor may be required for proper installation, item #34205
- Solid state design resists shock and vibration
- DOT/SAE and FMVSS 108

Item Number	Description	Package	Pack
31396	Low Beam	Boxed	1 Pc./Box
31397	High Beam	Boxed	1 Pc./Box

4x6 8 High Power LED Headlight

- 4"x6" rectangle headlight with 8 high power LEDs
- Improves visibility with whiter light output that is closer to daylight, output rated at 400 lumens
- Die-cast aluminum housing provides protection from the elements
- IP67 rating: Protects from dust and capable of withstanding water immersion, offering increased reliability and service life
- Dual power: use with 12VDC or 24VDC system, DOT/SAE approved

Item Number	Description	Package	Pack
31358	Low Beam	Boxed	1 Pc./Box
31359	High Beam	Boxed	1 Pc./Box



LED LIGHTS
4"x6" RECTANGULAR HEADLIGHTS



- 4"x6" Crystal Headlight W/ 9 Amber LED Position Light**
- 4"x6" rectangular crystal headlight w/ 9 amber LED position lights
 - Reinforced aluminum reflector
 - Rugged anti-vibration construction
 - Sold individually, please specify low beam or high beam

Item Number	Description	Package	Pack
31373	Low Beam	Boxed	1 Pc./Box
31374	High Beam	Boxed	1 Pc./Box



- 4"x6" Crystal Headlight W/ 9 White LED Position Light**
- 4"x6" rectangular crystal headlight with 9 white LED position lights
 - Reinforced aluminum reflector
 - Rugged anti-vibration construction
 - Sold individually, please specify low beam or high beam

Item Number	Description	Package	Pack
31368	Low Beam	Boxed	1 Pc./Box
31369	High Beam	Boxed	1 Pc./Box



4"x6" RECTANGULAR HEADLIGHTS

4"x6" Heated LED Headlight - Chrome

- Features a heating system that automatically de-ices the headlight according to ambient temperature
- Durable glass lens with heavy duty aluminum housing
- Plug & play with standard H4 style connector plug for easy instal.
- Low beam 1,000 lumens, 12-24VDC, 20 Watts
- High beam 1,200 lumens, 12-24VDC, 24 Watts
- Dimensions: 6.6" x 4.2" x 3.2"

Item Number	Description	Package	Pack
34131	Low Beam	Boxed	1 Pc./Box
34132	High Beam	Boxed	1 Pc./Box



4"x6" Heated LED Headlight - Black

- Features a heating system that automatically de-ices the headlight according to ambient temperature
- Durable glass lens with heavy duty aluminum housing
- Plug & play with standard H4 style connector plug for easy instal.
- Low beam 1,000 lumens, 12-24VDC, 20 Watts
- High beam 1,200 lumens, 12-24VDC, 24 Watts
- Dimensions: 6.6" x 4.2" x 3.2"

Item Number	Description	Package	Pack
34133	Low Beam	Boxed	1 Pc./Box
34134	High Beam	Boxed	1 Pc./Box



Dual Color High Power 12V H11 LED Bulbs - White/Yellow

- Specially engineered 240 degree wide angle dual color LED design
- Primary 6500k white color temp. LED with 1150 lumen output
- Secondary 3000k bright yellow color temp. LED w/ 1150 lumen output
- Features highly efficient rear heatsink design to help dissipate heat and prolong bulb life
- Small form factor in-line LED driver ballast
- Direct plug-n-play to H11 housing and socket
- Includes quality high temp rubber seal on bulb body
- White LED comes on by default. To switch over to yellow, simply turn off and on within 10 seconds
- Warning: yellow LED is designed for fog light use only, not to be used as normal driving light

Item Number	LEDs	Lens	Package	Pack
36468	2	White	Carded	2 Pc./Card



High Power 9005/HB3 LED Headlamp Bulb

- 2 high power CREE white LED headlamp bulb
- 10W low beam application, bright 1,200 lumen output, 6,000K
- Fan-less design, proprietary heat sink dissipates excess heat
- Sold individually

Item Number	Description	Package	Pack
36888	Low Beam	Boxed	1 Pc./Box



High Power 9005/HB3 LED Headlamp Bulb

- 12V, high beam and low beam function
- High beam 100 watt/low beam 80 watt
- Sold in pairs

Item Number	Description	Package	Pack
39132	High/Low Beam	Carded	2 Pc./Card



High Power 9006/HB4 LED Bulb (2 Pack)

- 20W low beam application
- 2300 lumen output
- Forced convection design with cooling fan and heat sink, to increase service life
- Includes driver/controller for easy installation, made to fit most 9006/HB4 applications
- Driver/controller is approximately 2 1/4" L x 15/16" W x 5/8" H

Item Number	LEDs	Lens	Package	Pack
36513	1 Amber	Amber	Carded	1 Pc./Card



High Power H4 LED Bulb with Fan

- 23 watt low beam application 25 watt high beam application
- 1800 lumen low beam output
- 2400 lumen high beam output
- Includes driver/controller for easy installation, replaces any H4 bulb.
- Driver/controller is approximately 2 3/16" L x 7/8" W x 5/8" H

Item Number	LEDs	Lens	Package	Pack
36512	1	White	Carded	1 Pc./Card



LED BULBS/ADAPTERS

High Power HB4 LED Bulb

- 3 CREE high power white LEDs
- 9 watt low beam application, 18W high beam application
- 1,000 lumen low beam output, 1,500 lumen high beam output
- Includes driver/controller for easy installation, replaces any H4 bulb, driver/controller is approximately 3 1/2" L x 1-3/4" W x 1" H

Item Number	LEDs	Lens	Package	Pack
36903	3	White	Carded	1 Pc./Card



High Power 9006/HB4 LED Bulb

- 2 CREE high power white LEDs
- 10 watt low beam application
- Fan-less design
- 1200 lumen output

Item Number	LEDs	Lens	Package	Pack
36904	2	White	Carded	1 Pc./Card



8 Watt High Power H8/H11/H16 LED Bulb

- High power H8/H11/H16 LED bulb
- 8 watt CREE LED, CREE LED are made in the U.S.A
- 500 lumens / 6000k brightness, 12V application
- Fan-less design, proprietary integrated heat sink design dissipates heat without use of external cooling fan
- Use of external cooling fan
- Includes in-line ballast

Item Number	LEDs	Lens	Package	Pack
36927	1	Clear	Carded	1 Pc./Card



LED Headlight PWM Anti-Flicker Module & Adaptor

- Works with most vehicles using pulse width modulated electrical systems, such as 2007-present Jeep JK
- Eliminates flicker on LED headlamps
- Adapts common H13 plug to H4 plug used by most LED headlights

Item Number	Description	Package	Pack
34217B	Ati-Flicker Module/Adapt.	Carded	1 Pc./Card



3 Contact Female Headlight Pigtail For H4 Halogen Bulb

- 3 contact female pigtail for H4 halogen bulb
- High heat resistant nylon wires in black, green and red color skin
- OEM # 01A-13076

Item Number	Description	Package	Pack
34222	Headlight Pigtail	Bulk	1 Pc./Bulk

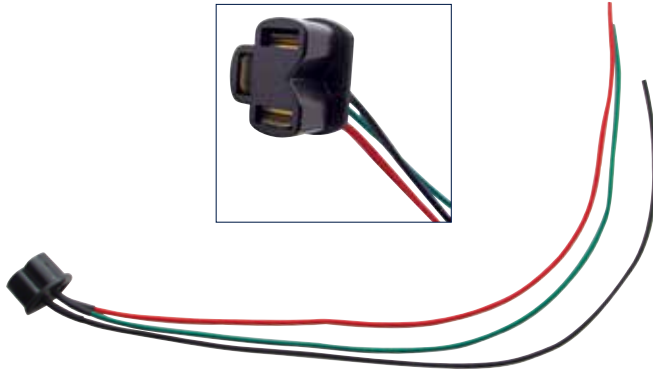

9005/9006 Headlight Relay Harness Kit

- Sends high amperage to headlamps
- Corrects dim lights on classic cars and hot rods
- Select proper kit to match your type of headlamp bulbs
- 12 Volt

Item Number	Description	Package	Pack
34264	Headlight Relay Harness	Carded	1 Pc./Card

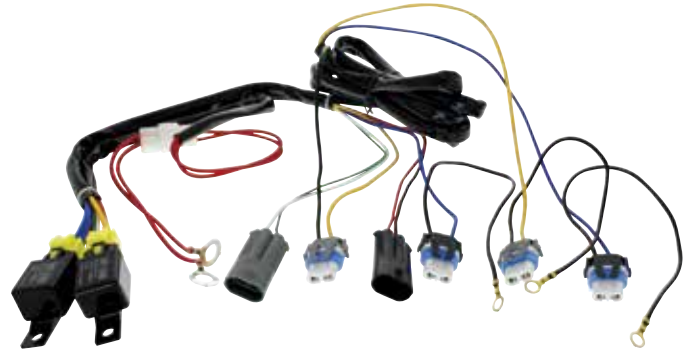

H4 Headlight Relay Harness Kit

- Sends high amperage to headlights
- Corrects dim lights on classic cars and hot rods
- Works on original style 6014 sealed beams
- 12 Volt

Item Number	Description	Package	Pack
34263	Headlight Relay Harness	Carded	1 Pc./Card

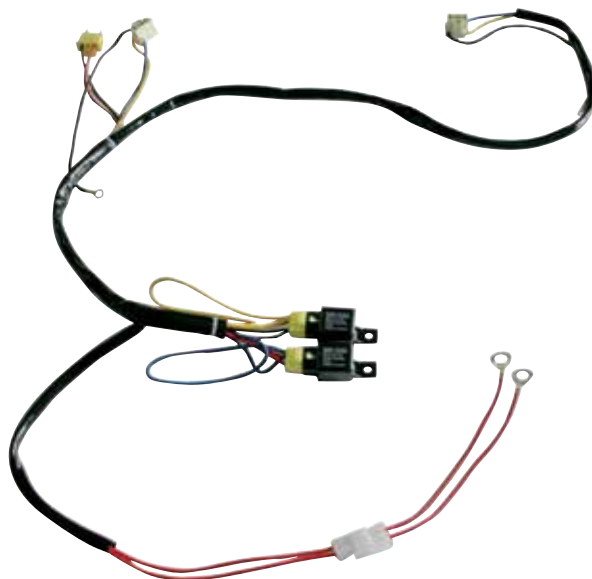

Dual Function LED Control Module

- Add dual function high/low brightness to 31378 and 31379 headlamps with 34 LED accent lights
- Built in split operation for motorcycle applications
- Easy plug & play hookup, wiring instructions included
- Sold individually, for 12 volt LED use only

Item Number	Description	Package	Pack
31372	LED Control Module	Carded	1 Pc./Card

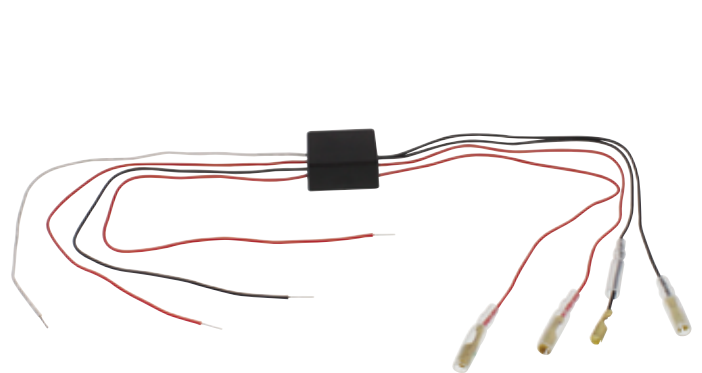

1933-35 Chevy Passenger Car

30 LED Tail Light w/ Black Housing & Chrome Rim

- 30 super bright red LED tail light w/ black housing & chrome rim
- Red polycarbonate lens, 12V
- Dual function with tail light & bright stop/turn signal
- Recommend to upgrade under dash flasher to item # 90642 or 90649 LED flasher

Item Number	LEDs	Lens	Application	Pack
CTL3335LED-BL	Red	Red	Driver	1 Pc./Box
CTL3335LED-BR	Red	Red	Passenger	1 Pc./Box



GM Restoration Parts.



1933-35 Chevy Passenger Car

30 LED Tail Light w/ Chrome Housing & Rim

- 30 super bright red LED tail light w/ chrome housing & rim
- Red polycarbonate lens, 12V
- Dual function with tail light & bright stop/turn signal
- Recommend to upgrade under dash flasher to item # 90642 or 90649 LED flasher

Item Number	LEDs	Lens	Application	Pack
CTL3335LED-CL	Red	Red	Driver	1 Pc./Box
CTL3335LED-CR	Red	Red	Passenger	1 Pc./Box



GM Restoration Parts.



1933-36 Chevy Passenger Car

LED Tail Light Lens

- 30 super bright red LEDs, driver side includes a 6 white LED license light
- Easy installation in original Tail Light housing with 1156 plug
- Epoxy coated, fully sealed electronics
- Solid state circuit boards are designed for 7.7 - 14.0 VDC
- Licensed by General Motors

Item Number	LEDs	Lens	Application	Pack
CTL3336LED-L	30 Red, 6 White	Red/Clear	Driver License	1 Pc./Card
CTL3336LED-R	30 Red	Red	Passenger	1 Pc./Card



GM Restoration Parts.

1937-38 Chevy Car & 1940-53 Chevy Truck

27 LED Sequential Tail Light Lens

- 27 super bright red LEDs with high quality polycarbonate lens
- LED license illuminator lens with 6 super bright white LEDs
- Features sequential function with selector switch to control sequential function off/on
- Also features brake attention option with sequence-once function
- Recommend to upgrade under dash flasher to item # 90652 or 90649 LED flasher

Item Number	LEDs	Lens	Application	Pack
110110	Red/White	Red	Driver	1 Pc./Card
110111	Red	Red	Passenger	1 Pc./Card



(((SEQUENTIAL)))
F.L.A.S.H. (((BRAKE)))
ATTENTION

1937-38 Chevy Passenger Car & 1940-53 Truck

45 LED Tail Light Lens

- 45 super bright red LEDs with high quality polycarbonate lens
- LED license illuminator lens with 6 super bright white LEDs
- Epoxy coated, fully sealed electronics, 3 wires hard wired
- Solid state circuit boards are designed for 7.7 - 14.0 VDC

Item Number	LEDs	Lens	Application	Pack
CTL4053LED-L	Red/White	Red	Driver License	1 Pc./Card
CTL4053LED-R	45 Red	Red	Passenger	1 Pc./Card



1937-38 Chevy Passenger Car

LED Tail Light - Passenger Side

- 6 super bright white LEDs, complete with polycarbonate lens
- Epoxy coated, fully sealed electronics
- Epoxy coated, fully sealed electronics
- Solid state circuit boards are designed for 7.7 - 14.0 VDC

Item Number	LEDs	Lens	Application	Pack
CTL4053LL	6 White	Clear	Passenger	1 Pc./Card

1937-38 Chevy Passenger Car

45 LED Tail Light w/ Stainless Steel Housing

- 45 red LED tail light and 6 white LED license plate light
- High quality injection molded polycarbonate lens
- Recommend to upgrade under dash flasher to item # 90652 or 90649 LED flasher

Item Number	LEDs	Lens	Application	Pack
C3704RL	45 Red	Red	Driver	1 Pc./Box
C3704RR	45 Red	Red	Passenger	1 Pc./Box



1937-38 Chevy Car & 1940-53 Chevy Truck

27 LED Sequential Tail Light Assembly w/ Black Housing

- 27 red LEDs with black powder coated housing & stainless rim and high quality polycarbonate lens
- Driver side includes LED license illuminator lens with 6 super bright white LEDs
- Also features brake attention option with sequence-once function
- Recommend to upgrade under dash flasher to item # 90652 or 90649 LED flasher

Item Number	LEDs	Lens	Application	Pack
110411	Red/White	Red	Driver	1 Pc./Box
110412	Red	Red	Passenger	1 Pc./Box



1940-53 Chevy & GMC Truck

27 LED Sequential Tail Light w/ Black Housing

- 27 super bright red LEDs with high quality polycarbonate lens
- Includes LED license illuminator lens w/ 6 super bright white LEDs
- Features sequential function with selector switch to control sequential function off/on
- Also features brake attention option with sequence-once function
- Energy efficient solid-state circuit board for 12V DC systems
- Recommend to upgrade under dash flasher to item # 90652 or 90649 LED flasher

Item Number	LEDs	Lens	Application	Pack
110415	27 Red	Red	Driver	1 Pc./Box
110414	27 Red	Red	Passenger	1 Pc./Box



(((SEQUENTIAL)))
F · L · A · S · H **(((BRAKE)))**
ATTENTION

1937-38 Chevy Passenger Car

27 LED Tail Light Assembly W/ Stainless Steel Housing

- 27 super bright red LEDs with high quality polycarbonate lens
- Includes LED license illuminator lens w/ 6 super bright white LEDs
- Features sequential function with selector switch to control sequential function off/on
- Also features brake attention option with sequence-once function
- Recommend to upgrade under dash flasher to item # 90652 or 90649 LED flasher

Item Number	LEDs	Lens	Application	Pack
110413	27 Red	Red	Driver	1 Pc./Box
110414	27 Red	Red	Passenger	1 Pc./Box



(((SEQUENTIAL)))
F · L · A · S · H **(((BRAKE)))**
ATTENTION



1937-38 Chevy Passenger Car & 1940-53 Truck

LED Tail Light with Blue Dot

- 27 super bright red LEDs with high quality injection molded polycarbonate lens and center mounted blue dot
- Driver side includes 6 white LED license light
- Epoxy coated, fully sealed electronics
- Solid state circuit boards are designed for 7.7 - 14.0 VDC
- Recommend to upgrade under dash flasher to item # 90652 or 90649 LED flasher

Item Number	LEDs	Lens	Application	Pack
CTL4053LED-LBD	27 Red 6 White	Red	Driver	1 Pc./Box
CTL4053LED-RBD	27 Red	Red	Passenger	1 Pc./Box

1937-38 Chevy Passenger Car

23 LED Tail Light W/ Stainless Steel Housing & Blue Dot

- 23 super bright LED with center mounted blue dot on high quality polycarbonate lens
- Includes 6 white LED for license plate
- Blue dot can be controlled independently with additional wiring
- Recommend to upgrade under dash flasher to item # 90652 or 90649 LED flasher

Item Number	LEDs	Lens	Application	Pack
C3704RLBD	Red/White	Red	Driver	1 Pc./Box
C3704RRBD	Red	Red	Passenger	1 Pc./Box



1939 Chevy Passenger Car

17 LED Tail Light With Chrome Or Primer Housing

- 17 super bright red LEDs, with high quality polycarbonate lens
- Epoxy coated, fully sealed electronics, 1157 plug
- Recommend to upgrade under dash flasher to item # 90652 or 90649 LED flasher

Item Number	Housing	Lens	Application	Pack
C3910CL	Chrome	Red	Driver	1 Pc./Box
C3910CR	Chrome	Red	Passenger	1 Pc./Box
C3910BL	Primer	Red	Driver	1 Pc./Box
C3910BR	Primer	Red	Passenger	1 Pc./Box



1939 Chevy Passenger Car

17 LED Amber Parking Light

- 17 super bright LED amber parking light with polycarbonate lens
- Epoxy coated, fully sealed electronics
- Easy wiring with hard wired 1157 double contact plug
- Energy efficient solid-state circuit board for 12V DC systems

Item Number	LEDs	Lens	Package	Pack
CPL3901AB	17 Amber	Amber	Carded	1 Pc./Card





1939 Chevy Passenger Car

17 LED Red Tail Light

- 17 super bright red LEDs, complete with polycarbonate lens
- Epoxy coated, fully sealed electronics, 1157 plug
- Energy efficient solid state circuit board for 12VDC systems
- Recommend to upgrade under dash flasher to item # 90652 or 90649 LED flasher
- Mounting pad sold separately: Item # CTL3918-1

Item Number	LEDs	Lens	Pack
CTL3918LED	17 Red	Red	1 Pc./Card

1939 Chevy Passenger Car

17 Red LED Vintage Style Round Tail Light

- 17 super bright red LEDs, for tail light/stop light/turn signal
- Flush mount design with mounting studs
- Mounting studs are approximately 2-3/4" apart
- 3 wires (hard wired)
- Recommend to upgrade under dash flasher to item # 90652 or 90649 LED flasher
- Mounting pad sold separately: Item # CTL3918-1

Item Number	LEDs	Lens	Pack
CTL3911LED	17 Red	Red	1 Pc./Card

1939 Chevy Passenger Car

17 Amber LED Vintage Style Round Parking Light

- 17 super bright amber LEDs for P/T/C
- Flush mount design with mounting studs
- Mounting studs are approximately 2-3/4" apart
- 3 wires (hard wired)
- Recommend to upgrade under dash flasher to item # 90652 or 90649 LED flasher
- Mounting pad sold separately: Item # CTL3918-1

Item Number	LEDs	Lens	Pack
CPL3911A	17 Amber	Amber	1 Pc./Card



LED LIGHTS
1940's CHEVY

1940 Chevy Passenger Car

22 LED Tail Light Lens

- 22 super bright red LEDs with high quality polycarbonate lens
- Epoxy coated, fully sealed electronics
- Energy efficient solid-state circuit board for 12V DC systems
- Recommend to upgrade under dash flasher to item # 90652 or 90649 LED flasher

Item Number	LEDs	Lens	Pack
CTL4010LED	22 Red	Red	1 Pc./Card



1940 Chevy Passenger Car

22 LED Tail Light With Chrome Rim

- 22 super bright red LEDs, with high quality polycarbonate lens
- Includes chrome rim, black housing, socket, bulb, and hardware
- Epoxy coated, fully sealed electronics
- Energy efficient solid-state circuit board for 12V DC systems
- Recommend to upgrade under dash flasher to item # 90652 or 90649 LED flasher

Item Number	LEDs	Lens	Pack
CTL4010LED-AS	22 Red	Red	1 Pc./Card



1941-48 Chevy Passenger Car

39 LED Tail Light

- 39 super bright red LEDs with high quality polycarbonate lens
- Epoxy coated, fully sealed electronics, 1157 plug
- Energy efficient solid-state circuit board engineered for 12VDC systems
- Recommend to upgrade under dash flasher to item # 90652 or 90649 LED flasher

Item Number	LEDs	Lens	Pack
CTL4248LED	39 Red	Red	1 Pc./Card
CTL4248C	39 Red	Clear	1 Pc./Card



1941-48 Chevy Passenger Car

39 LED Tail Light Assembly

- 39 super bright red LEDs, complete with polycarbonate lens
- Epoxy coated, fully sealed electronics, 1157 plug
- Stainless steel rim, black housing, rubber mounting pad included
- Mounting pad sold separately: Item # C4003-2

Item Number	LEDs	Lens	Application	Pack
C4061RL	39 Red	Red	Driver	1 Pc./Box
C4062RR	39 Red	Red	Passenger	1 Pc./Box
C4061CL	39 Red	Clear	Driver	1 Pc./Box
C4062RR	39 Red	Clear	Passenger	1 Pc./Box



1941-48 Chevy Passenger Car

39 LED Tail Light With Flush Mount Bezel

- 39 super bright red LEDs, flush mount light with polycarbonate lens
- Epoxy coated, fully sealed electronics
- Includes chrome die cast flush mount bezel and rubber mounting pad
- Chrome bezel available separately: item # CTL4248R

Item Number	LEDs	Lens	Pack
CTL424803	39 Red	Red	1 Pc./Card
CTL424804	39 Red	Clear	1 Pc./Card



1941-48 Chevy Passenger Car

39 LED Tail Light with LED Blue Dot

- 39 super bright LEDs with polycarbonate lens
- Blue dot with chrome plated rim looks exactly like original
- Dual function with tail light & bright stop/turn signal
- Blue dot can be controlled independently with additional wiring
- Easy electrical connection with 1157 plug, no modification to vehicle
- Recommend to upgrade under dash flasher to item # 90652 or 90649 LED flasher

Item Number	LEDs	Lens	Pack
CTL4248LEDBD	39 Red	Red	1 Pc./Card



1941-48 Chevy Passenger Car

36 LED Tail Light Assembly with Blue Dot

- 36 super bright red LED tail light with stainless steel rim and LED blue dot
- Epoxy coated, fully sealed electronics
- Stainless steel rim, black housing and mounting pad included
- Blue dot with chrome plated rim looks exactly as original
- Blue dot can be controlled independently with additional wiring
- Recommend to upgrade under dash flasher to item # 90652 or 90649 LED flasher

Item Number	LEDs	Application	Pack
C4061RLBD	36 Red	Driver	1 Pc./Box
C4062RRBD	36 Red	Passenger	1 Pc./Box



1941-48 Chevy Passenger Car

LED Tail Light with Blue Dot - Flush Mount

- 36 super bright red LED tail light with chrome bezel and LED blue dot
- Epoxy coated, fully sealed electronics
- Chrome die cast bezel with rubber mounting pad included
- Blue dot with chrome plated rim looks exactly as original
- Blue dot can be controlled independently with additional wiring
- Recommend to upgrade under dash flasher to item # 90652 or 90649 LED flasher

Item Number	LEDs	Blue Dot	Pack
CTL424805	36 Red	Yes	1 Pc./Card



1949-50 Chevy Passenger Car

16 LED Tail Light Assembly

- 16 super bright red LEDs, complete with polycarbonate lens
- Epoxy coated, fully sealed electronics, stamped stainless steel rim
- Includes housing, mounting hardware, round reflector, socket, wires
- Mounting pad available separately: Item # C495004
- Recommend to upgrade under dash flasher to item # 90652 or 90649 LED flasher

Item Number	LEDs	Application	Pack
CTL4950LED-ALS	16 Red	Driver	1 Pc./Box
CTL4950LED-ARS	16 Red	Passenger	1 Pc./Box



1949-50 Chevy Passenger Car

16 LED Tail Light Lens

- 16 super bright red LEDs, complete with polycarbonate lens
- Epoxy coated, fully sealed electronics, 1157 plug
- Energy efficient solid-state circuit board engineered for 12VDC
- Recommend to upgrade under dash flasher to item # 90652 or 90649 LED flasher

Item Number	LEDs	Lens	Pack
CTL4901LED	16 Red	Red	1 Pc./Card



1949-50 Chevy Passenger Car

Tail Light Mounting Pad

- High durability foam rubber material
- Exact shape and size as original to provide a tight seal
- Sold in pairs

Item Number	Description	Pack
C495004	Mounting Pad	1 Pair



1951-52 Chevy Passenger Car

16 LED Tail Light Assembly With Chrome Housing

- 16 super bright red LED with high quality polycarbonate lens
- Beautiful chrome plated housing with show ready chrome zinc die-cast bezel
- Includes chrome housing, mounting hardware, round reflector, socket and wires
- Mounting hardware, round reflector, socket and wiring included
- Recommend to upgrade under dash flasher to item # 90652 or 90649 LED flasher

Item Number	LEDs	Lens	Pack
CTL5152LED-AS	16 Red	Red	1 Pc./Box



1951-52 Chevy Passenger Car

16 LED Tail Light Lens

- 16 super bright red LED's with high quality polycarbonate lens
- Epoxy coated, fully sealed electronics, 1157 plug
- Energy efficient solid-state circuit board for 12VDC systems
- Recommend to upgrade under dash flasher to item # 90652 or 90649 LED flasher

Item Number	LEDs	Lens	Pack
CTL5152LED	16 Red	Red	1 Pc./Card
CTL5152C	16 Red	Clear	1 Pc./Card



1951-52 & 1956 Chevy Passenger Car

5 LED Tail Light Reflector

- 5 super bright LED's with high quality polycarbonate lens
- Mounting stud and nut included
- Mounting pad sold separately: Item # CTL5606P
- Recommend to upgrade under dash flasher to item # 90652 or 90649 LED flasher

Item Number	LEDs	Lens	Pack
CTL5606LED	5 Red	Red	1 Pc.
CTL5606A	5 Amber	Amber	1 Pc.
CTL5606W	5 White	White	1 Pc.

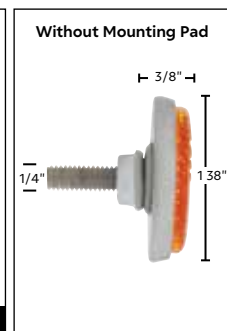

LED LIGHTS
1950's CHEVY

1953 Chevy Passenger Car

26 LED Tail Light

- 26 super bright LEDs with quality polycarbonate lens
- Epoxy coated, fully sealed electronics
- Energy efficient solid-state circuit board for 12VDC systems
- Recommend to upgrade under dash flasher to item # 90652 or 90649 LED flasher

Item Number	LEDs	Lens	Pack
CTL5310	26 Red	Red	1 Pc./Card



1953 Chevy Passenger Car

40 LED Tail Light Lens

- 40 super bright LEDs with high quality polycarbonate lens
- Stop/tail/turn function
- Epoxy coated, fully sealed electronics
- Energy efficient solid-state circuit board for 12VDC systems
- Recommend to upgrade under dash flasher to item # 90652 or 90649 LED flasher

Item Number	LEDs	Lens	Pack
CTL5312	40 Red	Red	1 Pc./Card



1953 Chevy Passenger Car

26 LED Backup Light Lens

- 26 super bright clear LEDs with clear lens
- High quality injection molded polycarbonate lens
- Epoxy coated, fully sealed electronics
- Energy efficient solid-state circuit board for 12V DC systems

Item Number	LEDs	Lens	Pack
CBL5311	26 White	Clear	1 Pc./Card



1954 Chevy Passenger Car

40 LED Tail Light

- 40 super bright red LEDs with high quality polycarbonate lens
- Epoxy coated, fully sealed electronics, 1157 plug
- Energy efficient solid-state circuit board for 12V DC systems
- Recommend to upgrade under dash flasher to item # 90652 or 90649 LED flasher

Item Number	LEDs	Lens	Pack
CTL5401LED	40 Red	Red	1 Pc./Card

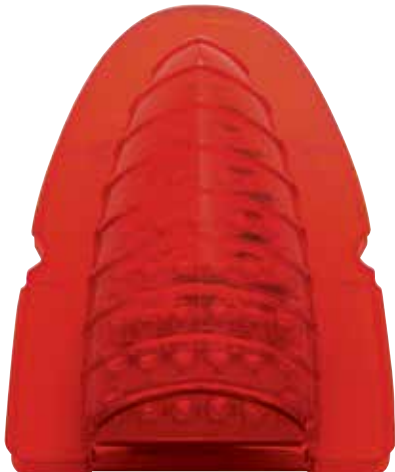

1954 Chevy Passenger Car

28 LED Back-Up Light

- 28 super bright LEDs with high quality polycarbonate lens
- Epoxy coated, fully sealed electronics, 1156 plug
- Energy efficient solid-state circuit board for 12V DC systems
- Recommend to upgrade under dash flasher to item # 90652 or 90649 LED flasher

Item Number	LEDs	Lens	Pack
CBL5451LED	28 Red	Clear	1 Pc./Card



1954 Chevy Passenger Car

40 LED Tail Light Assembly

- 40 LED tail light with chrome bezel, all lenses, gaskets, and backing plate
- Includes 28 LED backup lens
- 12V, includes tail light socket & backup light socket
- Mounting hardware and body seal included
- Epoxy coated, fully sealed electronics
- Recommend to upgrade under dash flasher to item # 90652 or 90649 LED flasher

Item Number	LEDs	Lens	Pack
CTL5408LED	40 Red/28White	Red/Clear	1 Pc./Box



1955 Chevy Passenger Car

60 LED Tail Light

- 60 super bright red LEDs with high quality polycarbonate lens
- Epoxy coated, fully sealed electronics, 1157 plug
- Energy efficient solid-state circuit board for 12V DC systems
- Recommend to upgrade under dash flasher to item # 90652 or 90649 LED flasher

Item Number	LEDs	Lens	Pack
CTL5510LED	60 Red	Red	1 Pc./Card



1955 Chevy Passenger Car

37 LED Parking and Turn Signal Light

- 37 super bright LEDs with high quality polycarbonate lens
- Epoxy coated, fully sealed electronics, 1157 plug
- Solid state circuit boards are designed for 7.7 - 14.0 VDC

Item Number	LEDs	Lens	Pack
CPL5531A	37 Amber	Amber	1 Pc./Card
CPL5531C	37 Amber	Clear	1 Pc./Card



1955 Chevy Passenger Car

26 LED Backup Light

- 26 super bright white LEDs with high quality polycarbonate lens
- Epoxy coated, fully sealed electronics, 1156 plug
- Energy efficient solid-state circuit board for 12V DC systems

Item Number	LEDs	Lens	Pack
CBL5511LED	26 White	Clear	1 Pc./Card





1955 Chevy Passenger Car

48 LED One-Piece Style Tail Light

- 48 SMD super bright red LEDs with high quality polycarbonate lens
- Direct plug & play installation with 1157 type connector
- Epoxy coated, fully sealed electronics, 1157 plug
- Energy efficient solid-state circuit board for 12V DC systems
- Recommend to upgrade under dash flasher to item # 90652 or 90649 LED flasher
- Recommend license plate with LED back-up light, item # 50187

Item Number	LED	Lens	Application	Pack
110206	48 Red	Red	Tail Light	1 Pc./Card



1955 Chevy Passenger Car

48 LED Sequential One-Piece Style Tail Light

- 48 SMD LED sequential tail light w/ high quality polycarbonate lens
- Features sequential function with selector switch to control sequential function off, direction left, or direction right
- Also features brake attention option with sequence-once function
- Epoxy coated, fully sealed electronics, 1157 plug
- Energy efficient solid-state circuit board for 12V DC systems
- Recommend to upgrade under dash flasher to item # 90652 or 90649 LED flasher
- Recommend license plate with LED back-up light, item # 50187

Item Number	LED	Lens	Application	Pack
110207	48 Red	Red	Tail Light	1 Pc./Card



SEQUENTIAL
F · L · A · S · H

BRAKE
ATTENTION



1957 Chevy Passenger Car

51 LED Tail Light

- 51 super bright red LEDs with high quality polycarbonate lens
- Epoxy coated, fully sealed electronics, 1157 plug
- Energy efficient solid-state circuit board for 12V DC systems
- Recommend to upgrade under dash flasher to item # 90652 or 90649 LED flasher

Item Number	LEDs	Lens	Pack
CTL5720LED	51 Red	Red	1 Pc./Card

1957 Chevy Passenger Car

32 LED Sequential Tail Light

- 32 super bright red LEDs with high quality polycarbonate lens
- Selector switch controls sequential function off, left, direction right
- Also features brake attention option with sequence-once function
- Epoxy coated, fully sealed electronics, 1157 plug
- Requires to upgrade under dash flasher to item # 90652 or 90649 LED flasher
- DOT & SAE FMVSS108

Item Number	LED	Lens	Application	Pack
110198	32 Red	Red	Tail Light	1 Pc./Card



(((SEQUENTIAL))) ((BRAKE ATTENTION))

LED LIGHTS
1950's CHEVY

1956 Chevy Passenger Car

40 LED Tail Light

- 40 super bright LEDs with high quality polycarbonate lens
- Epoxy coated, fully sealed electronics
- Energy efficient solid-state circuit board for 12V DC systems
- Recommend to upgrade under dash flasher to item # 90652 or 90649 LED flasher
- Due to space restriction, wires must be connected with included quick splice terminals

Item Number	LEDs	Lens	Pack
CTL5608LED	40 Red	Red	1 Pc./Card
CTL5608C	40 Red	Clear	1 Pc./Card



1956 Chevy Passenger Car

35 LED Parking Light

- 35 super bright amber LEDs with high quality polycarbonate lens
- Epoxy coated, fully sealed electronics, 1157 plug
- Energy efficient solid-state circuit board for 12V DC systems

Item Number	LEDs	Lens	Pack
CPL5601C	35 Amber	Clear	1 Pc./Card

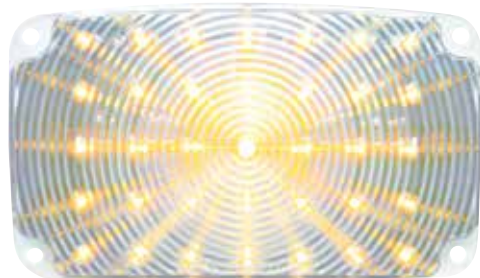

1956 Chevy Passenger Car

26 LED Backup Light Lens

- 26 Super bright white LEDs with high quality polycarbonate lens
- Epoxy coated, fully sealed electronics

Item Number	LEDs	Lens	Application	Pack
CBL5607LED	26 White	Clear	Backup Light	1 Pc./Card



1957 Chevy Car

17 LED Parking and Turn Signal Light

- 17 super bright LEDs with high quality polycarbonate lens
- Dual function with parking light & bright turn signal
- Epoxy coated, fully sealed electronics, 1157 plug
- Solid state circuit boards are designed for 7.7 - 14.0 VDC

Item Number	LEDs	Lens	Pack
CPL5702A	17 Amber	Amber	1 Pc./Card
CPL5702C	17 Amber	Clear	1 Pc./Card



1957 Chevy Passenger Car

28 LED Backup Light

- 28 super bright white LEDs with high quality polycarbonate lens
- Epoxy coated, fully sealed electronics, 1156 plug
- Lifetime warranty

Item Number	LEDs	Lens	Application	Pack
110221	28 White	Clear	Backup Light	1 Pc./Card



1955-60 Chevy Car

24 LED Dome Light

- 24 super bright white LEDs with high quality polycarbonate lens
- Beautiful chrome bezel with housing, whit lens, LED, and wires
- Does not fit 1955 Hardtop or Nomad

Item Number	LEDs	Lens	Pack
CDL555701-AS	24 White	Clear	1 Pc./Box



1955-60 Chevy Car

24 LED Dome Light Conversion

- 24 super bright white LEDs with high quality polycarbonate lens
- Simply installs in place of light bulb, connects with 1156 plug
- Does not fit 1955 Hardtop or Nomad

Item Number	LEDs	Lens	Pack
CDL555701	24 White	Clear	1 Pc./Card



LED LIGHTS
1950's CHEVY

1959 Cadillac

40 LED Tail Light

- 40 super bright LEDs with high quality polycarbonate lens
- Epoxy coated, fully sealed electronics
- 3 wires (1 wire with ring terminal)
- Energy efficient solid-state circuit board for 12V DC systems

Item Number	LEDs	Lens	Pack
CTL5901LED	40 Red	Red	1 Pc./Card



1959 Cadillac

40 LED Tail Light Assembly

- 40 super bright LEDs with high quality polycarbonate lens
- Includes chrome die cast bezel with mounting base
- Epoxy coated, fully sealed electronics
- 3 wires (1 wire with ring terminal)

Item Number	LEDs	Lens	Pack
CTL5911LED	40 Red	Red	1 Pc./Card



1959 Cadillac

40 LED Tail Light - Flush Mount

- 40 LED Tail Light with chrome die cast flush mount bezel
- Easy surface mounting with 2 studs
- Rubber mounting pad available separately: Item # CTL5903-1
- 12V, completely water proof
- Recommend to upgrade under dash flasher to item # 90652 or 90649 LED flasher

Item Number	LEDs	Lens	Pack
CTL5913LED	40 Red	Red	1 Pc./Box



1959 Cadillac

Flush Mount Bezel

- Flush mount bezel for 1959 Cadillac LED Tail Light
- Mounting studs are approximately 3 1/4" apart

Item Number	Description	Pack
CTL5903R	Flush Mount Bezel	1 Pc./Box

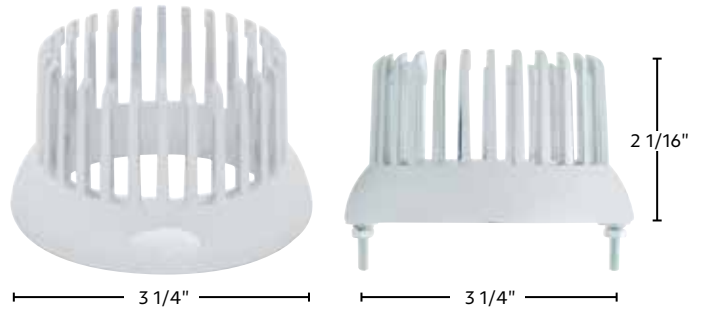

1959 Cadillac

Flush Mount Rubber Pad

- Flush mount rubber pad for 1959 Cadillac flush mount bezel

Item Number	Description	Pack
CTL5903-1	Mounting Pad Only	1 Pc.



1958 Chevy Impala

39 LED Parking Light Lens

- 39 super bright LED with high quality polycarbonate lens
- New lens is the same size & shape as the original Impala lens
- Dual function with parking light & bright turn signal
- Easy wiring with hard wired 1157 double contact plug
- Recommend to upgrade under dash flasher to item #90652 or 90649
- Hot tip: this LED can be used in place of the dummy lens, 2 LED each

Item Number	LEDs	Lens	Pack
CPL5801A	39 Amber	Amber	1 Pc./Card
CPL5801C	39 Amber	Clear	1 Pc./Card



1959 Chevy Impala

98 LED Tail Light - Retrofit

- 98 super bright LEDs, retrofit circuit board only
- Designed to fit 1959 Chevy Impala Tail Light using existing lens
- Epoxy coated, fully sealed electronics, 1157 plug
- Solid state circuit boards are designed for 7.7 - 14.0 VDC
- Fits United Pacific Tail Light lens: Item # C5901L and C5901R

Item Number	LEDs	Lens	Application	Pack
CTL5902LED-L	98 Red	Red	Driver	1 Pc./Card
CTL5902LED-R	98 Red	Clear	Passenger	1 Pc./Card



1958 Chevy Impala

Parking Light Lens Gasket

- Grey foam gasket, same as original, each car requires 4 gaskets
- Sold each, fits left hand and right hand side

Item Number	Description	Pack
C5851	Impala Lens Gasket	1 Pc.



1959 Chevy Impala

Tail Light Lens

- 1959 Chevy Impala Tail Light lens
- GM restoration licensed product

Item Number	LEDs	Lens	Application	Pack
C5901L	Red	Red	Driver	1 Pc./Bag
C5901R	Red	Red	Passenger	1 Pc./Bag

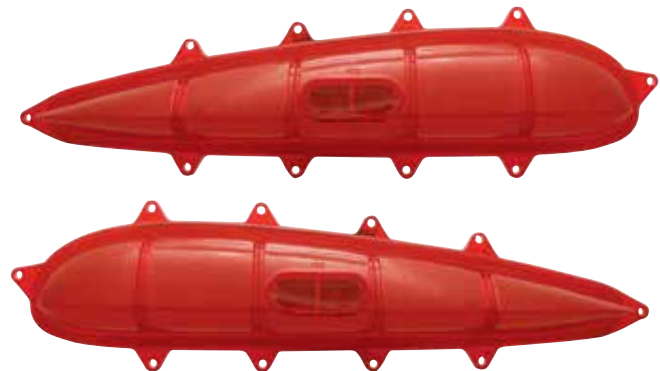

1959 Chevy Impala

Tail Light Lens Trim Set

- 8 polished stainless steel trim and 20 shoulder lens screws & nuts
- One set does both tail lamps

Item Number	Description	Pack
C5902	Trim + Nut & Bolt	1 Set/Box



C5902 - Trim + Nut & Bolt

LED LIGHTS
CHEVY CAMARO





LED LIGHTS
CHEVY CAMARO

1967 Chevy Camaro "Rally Sport"

40 LED Tail Light

- 40 super bright LEDs with high quality polycarbonate lens
- Epoxy coated, fully sealed electronics, 1157 plug
- Energy efficient solid-state circuit board for 12V DC systems
- Recommend upgrading under dash flasher to UP item # 90652 or 90649 LED flasher

Item Number	LEDs	Lens	Application	Pack
CTL6703LED	40 Red	Red	LH & RH	1 Pc./Card



1967 Chevy Camaro

40 LED Stop, Turn & Tail Light With Chrome Bezel

- 40 LED rectangular S/T/T light with chrome plastic bezel
- Flush mount
- Chrome bezel available separately: Item # 37961

Item Number	LEDs	Lens	Pack
37961	40 Red	Red	1 Pc.



1968 Chevy Camaro

LED Tail Light & Backup Light Lens

- 48 super bright red LED tail light lens & 20 super bright white LED backup light lens, high quality polycarbonate lens
- Dual function with tail light and bright stop/turn signal
- Epoxy coated, fully sealed electronics, 1157 plug
- Energy efficient solid-state circuit board for 12V DC systems
- Recommend upgrading under dash flasher to UP item # 90652 or 90649 LED flasher

Item Number	LEDs	Lens	Function	Pack
CTL6803LED	48 Red	Red	Tail	1 Pc./Card
CTL6853LED	20 White	Clear	Back-Up	1 Pc./Card



1968 Chevy Camaro "Rally Sport"

48 LED Tail Light - Rally Sport

- 48 super bright LEDs with high quality polycarbonate lens
- Dual function with tail light & bright stop/turn signal
- Epoxy coated, fully sealed electronics, 1157 plug
- Energy efficient solid-state circuit board for 12V DC systems
- Recommend upgrading under dash flasher to UP item # 90652 or 90649 LED flasher

Item Number	LEDs	Lens	Function	Pack
CTL6805LED	48 Red	Red	Tail	1 Pc./Card
CTL6803LED	48 Red	Red	Tail	1 Pc./Card



1969 Chevy Camaro "Rally Sport"

84 LED Tail Light

- 84 super bright red LEDs with red polycarbonate lens
- Rally sport style lens with stainless trim, all 3 segments are LED
- Upgrade to sequential function with item # 90656
- Epoxy coated, fully sealed electronics, 1157 plug
- Energy efficient solid-state circuit board for 12V DC systems
- Solid state circuit boards are designed for 7.7 - 14.0 VDC

Item Number	LEDs	Lens	Application	Pack
CTL6901LED-L	84 Red	Red	Driver	1 Pc./Box
CTL6901LED-R	84 Red	Red	Passenger	1 Pc./Box



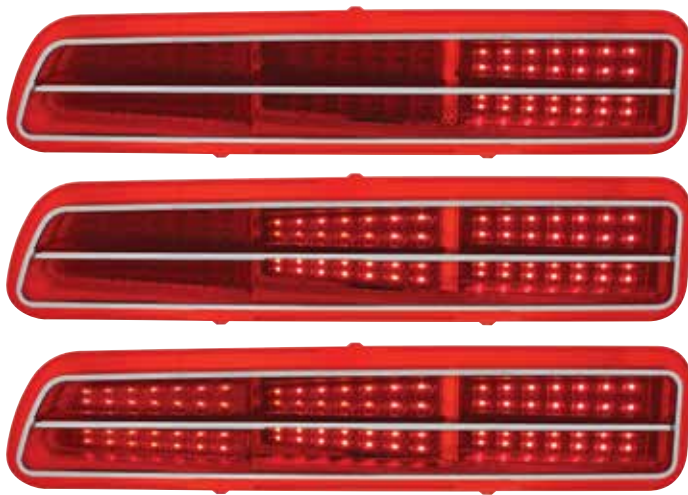

(((SEQUENTIAL))) ((BRAKE ATTENTION))

1969 Chevy Camaro

84 Sequential LED Tail Light Lens

- 84 super bright red LEDs with high quality injection molded polycarbonate lens and polished stainless steel trim ring
- Features sequential function with selector switch to control sequential function off/on
- Also features brake attention option with sequence-once function
- Epoxy coated, fully sealed electronic, 1157 double contact plug
- Energy efficient solid-state circuit board for 12V DC systems
- Recommend to upgrade under dash flasher to item # 90652 or 90649 LED flasher

Item Number	LEDs	Lens	Application	Pack
110108	84 Red	Red	Driver	1 Pc./Card
110109	84 Red	Red	Passenger	1 Pc./Card

1967 Chevy Camaro Standard

40 LED Tail Light

- 40 super bright red LEDs with high quality injection molded polycarbonate lens
- Will not fit RS model Camaro
- Energy efficient solid-state circuit board for 12V DC systems
- Recommend to upgrade under dash flasher to item # 90652 or 90649 LED flasher

Item Number	LEDs	Lens	Application	Pack
CTL6704LED	40 Red	Red	Tail Light	1 Pc./Card



1968 Chevy Camaro

48 LED Tail Light Lens

- 48 super bright red LEDs with high quality injection molded polycarbonate lens
- Epoxy coated, fully sealed electronics
- Easy wiring with hard wired 1157 double contact plug
- Energy efficient solid-state circuit board for 12V DC systems
- Recommend to upgrade under dash flasher to item # 90652 or 90649 LED flasher

Item Number	LEDs	Lens	Application	Pack
CTL6803C	48 Red	Clear	Tail Light	1 Pc./Card



1967 Chevy Camaro Standard

35 LED Backup Light Lens

- 35 Super bright white LEDs with high quality polycarbonate lens
- Epoxy coated, fully sealed electronics, 1156 plug
- Energy efficient solid-state circuit board for 12V DC systems

Item Number	LEDs	Lens	Application	Pack
CBL6704LED	35 White	Clear	Backup Light	1 Pc./Card



LED LIGHTS
CHEVY CAMARO

1968 Chevy Camaro

20 LED Backup Light Lens

- 20 super bright white LEDs with high quality polycarbonate lens
- Epoxy coated, fully sealed electronics, 1156 plug
- Energy efficient solid-state circuit board for 12V DC systems

Item Number	LEDs	Lens	Function	Pack
CBL6853LED	20 White	Clear	Back-Up	1 Pc./Card



1970-73 Chevy Camaro

30 LED Tail Light

- SEMA global media award winner
- 30 super bright LEDs, complete with polycarbonate lens
- Includes polished stainless steel lens trim attached
- Dual function with tail light and bright stop/turn signal
- Epoxy coated, fully sealed electronics, 1157 plug
- Recommend upgrading under dash flasher to UP item # 90652 or 90649 LED flasher

Item Number	LEDs	Lens	Application	Pack
CTL7073LED-L	30 Red	Red	Driver	1 Pc./Card
CTL7073LED-R	30 Red	Red	Passenger	1 Pc./Card



1969 Camaro "Rally Sport"

27 LED Backup Light

- 27 super bright white LEDs with high quality polycarbonate lens
- Epoxy coated, fully sealed electronics, 1156 plug
- Energy efficient solid-state circuit board for 12V DC systems
- Fits L/H or R/H side

Item Number	LEDs	Lens	Application	Pack
110443	27 White	Clear	Backup Light	1 Pc./Card



1970-73 Chevy Camaro

30 LED Backup Light

- 30 super bright white LED center backup light with 18 additional dual function red LED light
- Features polished stainless steel lens trim with high quality polycarbonate lens
- Additional red LEDs are designed for tail/stop/turn signal light use (quick splice connectors included)
- Fully sealed electronic solid state circuit boards are designed to operate at 12V DC
- Direct plug-n-play to original wiring harness with 1156 plug

Item Number	LEDs	Lens	Application	Pack
110375	30 Red/18White	Red	Driver	1 Pc./Card
110376	30 Red/18White	Red	Passenger	1 Pc./Card



1965 Chevy Chevelle & Malibu

41 LED Tail Light

- 41 super bright red LEDs with high quality injection molded polycarbonate lens and highly polished stainless steel trim
- Highly polished stainless steel trim
- Recommend to upgrade under dash flasher to item # 90652 or 90649 LED flasher

Item Number	LEDs	Lens	Application	Pack
CTL6521LED-L	41 Red	Red	Driver	1 Pc./Card
CTL6521LED-R	41 Red	Red	Passenger	1 Pc./Card



1967 Chevy Chevelle

68 LED Tail Light

- 68 super bright LEDs with high quality polycarbonate lens
- Epoxy coated, fully sealed electronics, 1157 plug
- Energy efficient solid-state circuit board for 12V DC systems
- Recommend upgrading under dash flasher to UP item # 90652 or 90649 LED flasher

Item Number	LEDs	Lens	Function	Pack
CTL6701LED	68 Red	Red	Tail Light	1 Pc./Card
CTL6701C	68 Red	Clear	Tail Light	1 Pc./Card



1964 Chevy Chevelle

23 LED Tail Light Lens

- 23 super bright LEDs with high quality polycarbonate lens
- Dual function with tail light & bright stop/turn signal
- Epoxy coated, fully sealed electronics, 1157 plug
- Recommend upgrading under dash flasher to UP item # 90652 or 90649 LED flasher

Item Number	LEDs	Lens	Application	Pack
CTL6402LED-L	23 Red	Red	Driver	1 Pc./Card
CTL6402LED-R	23 Red	Red	Passenger	1 Pc./Card



LED LIGHTS
CHEVY CHEVELLE/MALIBU

1970 Chevy Chevelle

48 LED Sequential Tail Light Insert Boards

48 LED Non-Sequential Tail Light Insert Boards

- 48 super bright red LED tail light insert board
- Features sequential function with selector switch to control sequential function off/on
- Also features brake attention option with sequence-once function
- Epoxy coated, fully sealed electronics, 1157 plug
- Energy efficient solid-state circuit board for 12V DC systems
- Recommend to upgrade under dash flasher to item # 90652 or 90649 LED flasher



Item Number	LEDs	Sequential	Application	Pack
110157	48 Red	Sequential	Driver	1 Pc./Card
110158	48 Red	Sequential	Passenger	1 Pc./Card
110155	48 Red	Non-Sequential	Driver	1 Pc./Card
110156	48 Red	Non-Sequential	Passenger	1 Pc./Card

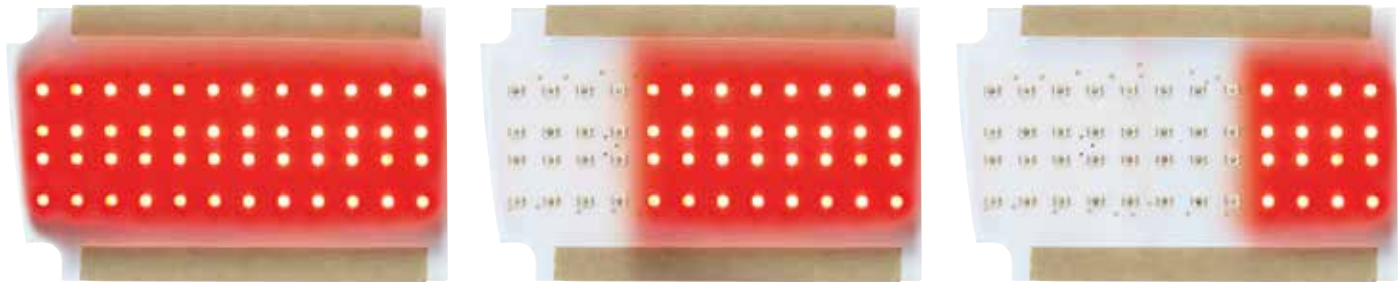

««« SEQUENTIAL »»»
(((BRAKE ATTENTION)))
F · L · A · S · H

1968 Chevy Chevelle

50 LED Tail Light

- 50 super bright LED with high quality polycarbonate lens
- Epoxy coated, fully sealed electronics, 1157 plug
- Energy efficient solid-state circuit board for 12V DC systems
- Recommend upgrading under dash flasher to UP item # 90652 or 90649 LED flasher

Item Number	LEDs	Lens	Application	Pack
CTL6821LED-L	50 Red	Red	Driver	1 Pc./Card
CTL6821LED-R	50 Red	Red	Passenger	1 Pc./Card

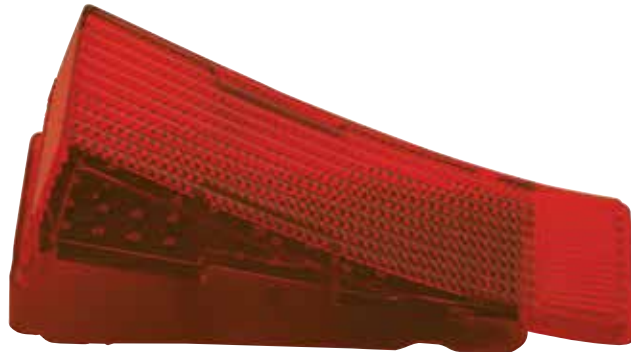

1971 Chevy Chevelle SS & Malibu

46 LED Tail Light Lens With Stainless Steel Trim

- 46 super bright red LED tail light with polycarbonate lens and stainless steel trim
- Dual function with tail light and bright stop/turn signal
- Epoxy coated, fully sealed electronics
- Easy wiring with hard wired 1157 double contact plug
- Recommend to upgrade under dash flasher to item # 90652 or 90649 LED flasher
- Lifetime warranty

Item Number	LEDs	Lens	Application	Pack
CTL7101LED-L	46 Red	Red	Driver	1 Pc./Card
CTL7101LED-R	46 Red	Red	Passenger	1 Pc./Card



1972 Chevy Chevelle SS & Malibu

42 LED Tail Light Lens With Stainless Steel Trim

- 42 super bright red LED tail light with polycarbonate lens and stainless steel trim
- Dual function with tail light and bright stop/turn signal
- Epoxy coated, fully sealed electronics
- Easy wiring with hard wired 1157 double contact plug
- Recommend to upgrade under dash flasher to item # 90652 or 90649 LED flasher

Item Number	LEDs	Lens	Application	Pack
CTL7201LED-L	42 Red	Red	Driver	1 Pc./Card
CTL7201LED-R	42 Red	Red	Passenger	1 Pc./Card



1972 Chevy Chevelle SS & Malibu

34 LED Backup Light

- 34 super bright white LEDs with high quality polycarbonate lens and stainless steel trim
- Epoxy coated, fully sealed electronics, 1156 plug
- Lifetime warranty

Item Number	LEDs	Lens	Application	Pack
CBL7201LED-L	34 White	Red/Clear	Driver	1 Pc./Card
CBL7201LED-R	34 White	Red/Clear	Passenger	1 Pc./Card



1971 Chevy Chevelle SS & Malibu

21 LED Backup Light

- 21 super bright white LEDs with high quality polycarbonate lens and stainless steel trim
- Epoxy coated, fully sealed electronics, 1156 plug
- Lifetime warranty

Item Number	LEDs	Lens	Application	Pack
CBL7101LED-L	21 White	Red/Clear	Driver	1 Pc./Card
CBL7101LED-R	21 White	Red/Clear	Passenger	1 Pc./Card



LED LIGHTS
CHEVY CORVETTE

1963-66 Chevy Corvette

20 LED Backup Light

- 20 super bright white LEDs, complete with polycarbonate lens
- Epoxy coated, fully sealed electronics, 1156 plug
- Energy efficient solid-state circuit board for 12V DC systems

Item Number	LEDs	Lens	Application	Pack
CBL6366LED	20 White	Clear	Back-Up	1 Pc./Card



1967 Chevy Corvette

20 LED Backup Light Lens

- 20 super bright white LEDs, complete with polycarbonate lens
- Epoxy coated, fully sealed electronics, 1156 plug
- Energy efficient solid-state circuit board for 12V DC systems

Item Number	LEDs	Lens	Application	Pack
CBL6711LED	20 White	Clear	Driver	1 Pc./Card
CBL6712LED	20 White	Clear	Passenger	1 Pc./Card



1968-73 Chevy Corvette

17 LED Tail Light With Stainless Steel Trim

- 17 super bright red LEDs, complete with polycarbonate lens and stainless steel trim
- Epoxy coated, fully sealed electronics, 1157 plug
- Solid state circuit boards are designed for 7.7 - 14.0 VDC
- Recommend upgrading under dash flasher to UP item # 90652 or 90649 LED flasher

Item Number	LEDs	Lens	Application	Pack
CTL6804LED	17 Red	Red	Tail Light	1 Pc./Card



1968-73 Chevy Corvette

20 LED Backup Light

- 20 super bright white LEDs, complete with polycarbonate lens and stainless steel trim
- Epoxy coated, fully sealed electronics, 1156 plug
- Energy efficient solid-state circuit board for 12V DC systems

Item Number	LEDs	Lens	Application	Pack
CBL6951LED	20 White	Red/Clear	Back-Up	1 Pc./Card



1990-96 Chevy Corvette

30 LED Tail Light

- 30 super bright white LEDs with high quality polycarbonate lens
- Epoxy coated, fully sealed electronics, 1157 plug
- Energy efficient solid-state circuit board for 12V DC systems
- Recommend to upgrade under dash flasher to item # 90652 or 90649 LED flasher

Item Number	LEDs	Lens	Application	Pack
CTL9096LED	30 Red	Red	Tail light	1 Pc./Card



1975-82 Chevy Corvette

25 LED Bubble Style Tail Light

- 25 super bright red LEDs complete with polycarbonate lens
- Most corvette customers install four per car (use 50121 back-up light)
- Epoxy coated, fully sealed electronics, 1157 plug
- Energy efficient solid-state circuit board for 12V DC systems
- 1975-79 note: must trim plastic mounting legs to match 1975-79 size
- Recommend to upgrade under dash flasher to item # 90652 or 90649 LED flasher

Item Number	LEDs	Lens	Application	Pack
CTL7582LED	25 Red	Red	Tail Light	1 Pc./Card



1980-82 Chevy Corvette

19 Chevy Corvette LED Tail Light

- 19 super bright red LEDs, complete with polycarbonate lens
- Most corvette customers install four per car (use 50121 back-up light)
- Epoxy coated, fully sealed electronics, 1157 plug
- Energy efficient solid-state circuit board for 12V DC systems
- Will fit 1975-79 note: must trim plastic mounting legs to match 1975-79 size
- Recommend to upgrade under dash flasher to item # 90652 or 90649 LED flasher

Item Number	LEDs	Lens	Application	Pack
CTL8010LED	19 Red	Red	Tail Light	1 Pc./Card
CTL8010C	19 Red	Clear	Tail Light	1 Pc./Card



1984-90 Chevy Corvette

19 LED Tail Light

- 19 super bright red LEDs with high quality polycarbonate lens
- Epoxy coated, fully sealed electronics, 1157 plug
- Energy efficient solid-state circuit board for 12V DC systems
- Recommend to upgrade under dash flasher to item # 90652 or 90649 LED flasher

Item Number	LEDs	Lens	Application	Pack
CTL8490LED	19 Red	Red	Tail Light	1 Pc./Card



LED LIGHTS
CHEVY CORVETTE

1956-57 Chevy Corvette

15 LED Tail Light

- 15 super bright red LEDs with high quality polycarbonate lens
- Epoxy coated, fully sealed electronics
- Easy wiring with hard wired 1157 double contact plug, 12V only
- Recommend to upgrade to under dash flasher to item #90652 or 90649 LED flasher

Item Number	LEDs	Lens	Application	Pack
CTL5701LED	15 Red	Red	Tail light	1 Pc./Card



1953-62 Chevy Corvette

25 LED Front Parking Light

- 25 super bright LEDs with high quality polycarbonate lens
- Dual function with parking light and bright turn signal
- 1953-57 Corvette may require a small notch to be filed on back edge of lens
- Easy wiring with hard wired 1157 double contact plug
- Recommend to upgrade to under dash flasher to item #90652 or 90649 LED flasher

Item Number	LEDs	Lens	Application	Pack
CPL5362A	25 Amber	Amber	Parking	1 Pc./Card
CPL5362C	25 Amber	Clear	Parking	1 Pc./Card



1958-67 Chevy Corvette

1958-60 Passenger Car

13 LED Tail Light Lens

- 13 super bright red LEDs with high quality polycarbonate lens
- Epoxy coated, fully sealed electronics, 1157 plug
- Energy efficient solid-state circuit board for 12V DC systems
- Recommend to upgrade to under dash flasher to item #90652 or 90649 LED flasher

Item Number	LEDs	Lens	Application	Pack
CTL5860LED	15 Red	Red	Tail Light	1 Pc./Card



1958-60 Chevy Corvette

Outer Tail Light Lens

- Quality polycarbonate lens with polished stainless steel strip
- Quality red polycarbonate lens

Item Number	LEDs	Lens	Application	Pack
C5860	-	Red	Tail Light	1 Pc./Card





1963-67 Chevy Corvette
25 LED 12V Front Parking Light

- 25 super bright LEDs with high quality polycarbonate lens
- Epoxy coated, fully sealed electronics
- Easy wiring with hard wired 1157 double contact plug
- Dual function with parking light & bright turn signal

Item Number	LEDs	Lens	Package	Pack
CPL6367A	25 Amber	Amber	Carded	1 Pc./Card
CPL6367C	25 Amber	Clear	Carded	1 Pc./Card

1958 Chevy Passenger Car
1958-67 Chevy Corvette
13 LED Tail Light Lens

- 13 super bright red LEDs with high quality polycarbonate lens
- Epoxy coated, fully sealed electronics, 1157 plug
- Solid state circuit boards are designed for 7.7 - 14.0 VDC

Item Number	LEDs	Lens	Pack
CTL5860LED	13 Red	Red	1 Pc./Card



1963-66 Chevy Corvette
20 LED Backup Light

- 20 super bright white LEDs with high quality polycarbonate lens
- Epoxy coated, fully sealed electronics, 1156 plug
- Energy efficient solid-state circuit board for 12V DC systems

Item Number	LEDs	Lens	Pack
CBL6366LED	20 White	White	1 Pc./Card



LED LIGHTS
CHEVY EL CAMINO/WAGON



1968 Chevy El Camino & Station Wagon

30 LED Tail Light Lens

- 30 super bright LEDs with high red polycarbonate lens
- Dual function with tail light & bright stop/turn signal
- Epoxy coated, fully sealed electronics, 1157 plug
- Recommend upgrading under dash flasher to UP item # 90652 or 90649 LED flasher

Item Number	LEDs	Lens	Application	Pack
CTL6869LED-L	30 Red	Red	Driver	1 Pc./Card
CTL6869LED-R	30 Red	Red	Passenger	1 Pc./Card

1970-72 Chevy El Camino & Station Wagon

36 LED Tail Light

- 36 super bright red LEDs, complete with polycarbonate lens
- Dual function with Tail Light and bright stop/turn signal
- Epoxy coated, fully sealed electronics, 1157 plug
- Recommend upgrading under dash flasher to UP item # 90652 or 90649 LED flasher

Item Number	LEDs	Lens	Application	Pack
CTL7072LED-L	36 Red	Red	Driver	1 Pc./Card
CTL7072LED-R	36 Red	Red	Passenger	1 Pc./Card



1969 -72 Chevy El Camino

24 LED Backup Light

- 24 Super bright white LEDs with high quality polycarbonate lens
- Epoxy coated, fully sealed electronics, 1156 plug
- Energy efficient solid-state circuit board engineered for 12V DC systems, Lifetime warranty

Item Number	LEDs	Lens	Application	Pack
110458	24 White	Clear	Backup Light	1 Pc./Card

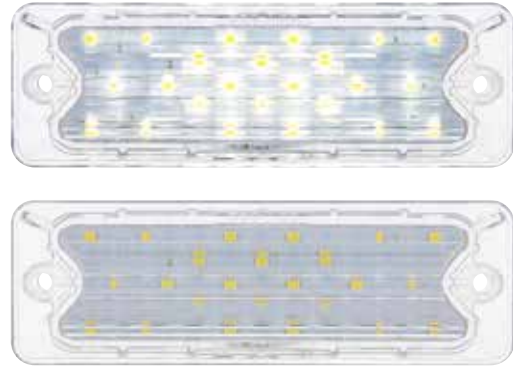

1960-61 Chevy Impala

40 LED Tail Light

- 40 super bright red LED with high quality polycarbonate lens
- Epoxy coated, fully sealed electronics, 1157 plug
- Solid state circuit boards are designed for 7.7 - 14.0 VDC
- Chrome bezel and seals sold separately, item # C6102 & C606306
- Energy efficient solid-state circuit board for 12V DC systems
- Recommend to upgrade to under dash flasher to item #90652 or 90649 LED flasher

Item Number	LEDs	Lens	Pack
CTL6061LED	40 Red	Red	1 Pc./Card



1961 Chevy Impala

40 LED Tail Light W/ Polished Aluminum Housing & Rim

- 40 super bright red LEDs with high quality polycarbonate lens
- Includes polished aluminum housing and lens trim
- Socket with wires included, 12 volt
- Recommend to upgrade to under dash flasher to item #90652 or 90649 LED flasher

Item Number	LEDs	Lens	Pack
CTL6111LED	40 Red	Red	1 Pc./Box



1960-61 Chevy Impala

40 LED Back-Up Light

- 40 super bright white LEDs with high quality polycarbonate lens
- Epoxy coated, fully sealed electronics, 1156 plug
- Energy efficient solid-state circuit board for 12V DC systems

Item Number	LEDs	Lens	Pack
CBL6051	40 White	Clear	1 Pc./Card



1961 Chevy Impala

40 LED Tail Light Assembly

- Complete assembly with 40 super bright white LEDs
- Includes polished aluminum housing and lens trim
- Epoxy coated, fully sealed electronics, 12 volt
- Energy efficient solid-state circuit board for 12V DC systems

Item Number	LEDs	Lens	Pack
CBL6111LED	40 White	Clear	1 Pc./Box



LED LIGHTS
CHEVY IMPALA

1962 Chevy Impala

40 LED Tail Light Lens

- 40 super bright red LEDs with high quality polycarbonate lens
- Epoxy coated, fully sealed electronics, 1157 plug
- Energy efficient solid-state circuit board for 12V DC systems
- Recommend to upgrade to under dash flasher to item #90652 or 90649 LED flasher

Item Number	LEDs	Lens	Pack
CTL6201LED	40 Red	Red	1 Pc./Card



1962 Chevy Impala

26 LED Backup Light

- 26 Super bright white LEDs with high quality polycarbonate lens
- Epoxy coated, fully sealed electronics, 1156 plug
- Energy efficient solid-state circuit board for 12V DC systems

Item Number	LEDs	Lens	Application	Pack
CBL6251LED	26 White	Red/Clear	Backup Light	1 Pc./Card



1963 Chevy Impala

40 LED Tail Light

- 40 super bright red LEDs with high quality polycarbonate lens
- Epoxy coated, fully sealed electronics, 1157 plug
- Energy efficient solid-state circuit board for 12V DC systems
- Use chrome bezel part # C6301P, lens gasket part # C6351
- Recommend to upgrade to under dash flasher to item #90652 or 90649 LED flasher

Item Number	LEDs	Lens	Pack
CTL6301LED	40 Red	Red	1 Pc./Card



1963 Chevy Impala

26 LED Backup Light Lens

- 26 super bright white LEDs with high quality polycarbonate lens
- Epoxy coated, fully sealed electronics, 1156 plug
- Energy efficient solid-state circuit board for 12V DC systems
- Use chrome bezel part # C6301P, lens gasket part # C6351

Item Number	LEDs	Lens	Pack
CBL6351LED	26 Red	Red/Clear	1 Pc./Card



1964 Chevy Impala

41 LED Tail Light Lens

- 41 super bright LEDs with high quality polycarbonate lens
- Epoxy coated, fully sealed electronics, 1157 plug
- Energy efficient solid-state circuit board for 12V DC systems
- Recommend to upgrade to under dash flasher to item #90652 or 90649 LED flasher

Item Number	LEDs	Lens	Pack
CTL6401LED	41 Red	Red	1 Pc./Card



1964 Chevy Impala

26 LED Backup Light

- 26 Super bright white LEDs with high quality polycarbonate lens
- Epoxy coated, fully sealed electronics, 1156 plug
- Energy efficient solid-state circuit board for 12V DC systems

Item Number	LEDs	Lens	Application	Pack
CBL6451LED	26 White	Red/Clear	Backup Light	1 Pc./Card



1964 Chevy Impala

41 LED Backup Light Assembly

- 41 super bright white LEDs with high quality polycarbonate lens
- Complete with polished anodized aluminum housing, chrome bezel, lens gasket and socket housing, lens gasket and socket
- Energy efficient solid-state circuit board for 12V DC systems
- Recommend to upgrade to under dash flasher to item #90652 or 90649 LED flasher

Item Number	LEDs	Lens	Pack
CBL6411LED	41 White	Clear	1 Pc./Box



1964 Chevy Impala

41 LED Tail Light With Chrome Bezel

- 41 super bright red LEDs with high quality polycarbonate lens
- Complete with polished anodized aluminum housing, chrome bezel, lens gasket and socket housing, lens gasket and socket
- Epoxy coated, fully sealed electronics, 1157 plug
- Energy efficient solid-state circuit board for 12V DC systems
- Recommend to upgrade to under dash flasher to item #90652 or 90649 LED flasher

Item Number	LEDs	Lens	Pack
CTL6411LED	41 Red	Red	1 Pc./Box



LED LIGHTS
CHEVY IMPALA

1965 Chevy Impala

41 LED Tail Light With Stainless Trim

- 41 super bright LEDs with high quality polycarbonate lens
- Polished stainless steel trim
- Epoxy coated, fully sealed electronics, 1157 plug
- Energy efficient solid-state circuit board for 12V DC systems
- Recommend to upgrade to under dash flasher to item #90652 or 90649 LED flasher

Item Number	LEDs	Lens	Pack
CTL6501LED	41 Red	Red	1 Pc./Card
CTL6501C	41 Red	Clear	1 Pc./Card



1965 Chevy Impala

26 LED Back-Up Light With Stainless Trim

- 26 super bright white LEDs, w/ polycarbonate lens and stainless trim
- Epoxy coated, fully sealed electronics, 1156 plug
- Solid state circuit boards are designed for 7.7 - 14.0 VDC

Item Number	LEDs	Lens	Pack
CBL6551LED	26 Red	Red/Clear	1 Pc./Card



1966 Chevy Impala

30 LED Parking Light Lens

- 30 super bright amber LEDs with high quality polycarbonate lens
- New lens is the same size & shape as original Impala lens
- Dual function with parking light & bright turn signal
- Easy electrical connection with 1157 plug, no modification to vehicle
- Recommend to upgrade under dash flasher to item # 90652 or 90649 LED flasher
- Gasket sold separately, item # C6651

Item Number	LEDs	Lens	Pack
CPL6601LED	30 Amber	Amber	1 Pc./Box



1967 Chevy Impala

27 LED Parking Light Lens

- 27 super bright amber LEDs with high quality polycarbonate lens
- New lens is the same size & shape as original Impala lens
- Dual function with parking light & bright turn signal
- Easy electrical connection with 1157 plug, no modification to vehicle
- Recommend to upgrade under dash flasher to item # 90652 or 90649 LED flasher
- Gasket sold separately, item # C6751

Item Number	LEDs	Lens	Pack
CPL6701LED	27 Amber	Amber	1 Pc./Box



1968 Chevy Caprice/Impala

40 LED Tail Light With Stainless Steel Trim

- 40 super bright red LEDs with high quality polycarbonate lens
- Beautiful polished outer and inner stainless steel trims
- Epoxy coated, fully sealed electronics, 1157 plug
- Energy efficient solid-state circuit board for 12V DC systems
- Recommend to upgrade to under dash flasher to item #90652 or 90649 LED flasher

Item Number	LEDs	Lens	Function	Pack
CTL6801LED	40 Red	Red	Tail	1 Pc./Card
CTL6801C	40 Red	Clear	Tail	1 Pc./Card



1968 Chevy Bel-Air/Biscayne

40 LED Tail light With Stainless Steel Center Trim

- 40 super bright red LEDs with high quality polycarbonate lens
- Beautiful polished inner stainless steel trim
- Epoxy coated, fully sealed electronics, 1157 plug
- Energy efficient solid-state circuit board for 12V DC systems

Item Number	LEDs	Lens	Function	Pack
CTL6802LED	40 Red	Red	Tail	1 Pc./Card



1968 Chevy Caprice/Impala

26 LED Backup Light With Stainless Steel Trim

- 26 super bright red LEDs with high quality polycarbonate lens
- Beautiful polished outer and inner stainless steel trims
- Epoxy coated, fully sealed electronics, 1157 plug
- Energy efficient solid-state circuit board for 12V DC systems

Item Number	LEDs	Lens	Function	Pack
CBL6851LED	26 White	Clear	Back-Up	1 Pc./Card



1968 Chevy Bel Air/Biscayne

26 LED Backup Light W/ Stainless Steel Trim

- 26 super bright white LEDs with high quality polycarbonate lens
- Beautiful polished outer and inner stainless steel trims
- Epoxy coated, fully sealed electronics, 1157 plug
- Energy efficient solid-state circuit board for 12V DC systems

Item Number	LEDs	Lens	Function	Pack
CBL6852LED	26 White	Clear	Back-Up	1 Pc./Card



1966-67 Chevy Nova

30 LED Tail Light

- 30 super bright LEDs with high quality polycarbonate lens
- Epoxy coated, fully sealed electronics, 1157 plug
- Energy efficient solid-state circuit board for 12V DC systems
- Recommend to upgrade under dash flasher to item # 90652 or 90649 LED flasher

Item Number	LEDs	Lens	Pack
CTL6667LED	30 Red	Red	1 Pc./Card



1966-67 Chevy Nova

24 LED Backup Light

- 24 super bright LEDs with high quality polycarbonate lens
- Epoxy coated, fully sealed electronics, 1156 plug
- Energy efficient solid-state circuit board for 12V DC systems

Item Number	LEDs	Lens	Pack
CBL6667LED	24 White	Clear	1 Pc./Card



1966-67 Chevy II & Nova

68 LED One-Piece Style Tail Light

- 68 SMD LED tail light w/ high quality red polycarbonate lens
- Custom style on-piece design with backup light deleted
- Epoxy coated, fully sealed electronics, 1157 plug
- Energy efficient solid-state circuit board for 12V DC systems
- Recommend license plate with LED backup light, item # 50187
- Recommend to upgrade under dash flasher to item # 90652 or 90649 LED flasher

Item Number	LEDs	Lens	Pack
110359	68 Red	Red	1 Pc./Card



1966-67 Chevy II & Nova

68 LED Sequential One-Piece Style Tail Light

- 68 SMD super bright LED sequential tail light with high quality polycarbonate lens
- Custom style on-piece design with backup light deleted
- Features sequential function with selector switch to control sequential function off, direction left, or direction right
- Also features brake attention option with sequence-once function
- Epoxy coated, fully sealed electronics, 1157 plug
- Solid state circuit boards are designed for 7.7 - 14.0 VDC
- Recommend license plate with LED backup light, item # 50187
- Recommend to upgrade under dash flasher to item # 90652 or 90649 LED flasher

Item Number	LEDs	Lens	Pack
110360	68 Red	Red	1 Pc./Card



1962-64 Chevy Nova

26 LED Tail Light Lens

- 26 super bright LEDs with high quality polycarbonate lens
- Epoxy coated, fully sealed electronics, 1157 plug
- Solid state circuit boards are designed for 7.7 - 14.0 VDC
- Energy efficient solid-state circuit board for 12V DC systems
- Recommend to upgrade under dash flasher to item # 90652 or 90649 LED flasher

Item Number	LEDs	Lens	Pack
CTL6264LED	26 Red	Red	1 Pc./Card



1962-64 Chevy Nova

32 LED Backup Light

- 32 super bright white LEDs with high quality polycarbonate lens
- Epoxy coated, fully sealed electronics, 1156 plug
- Energy efficient solid-state circuit board for 12V DC systems

Item Number	LEDs	Lens	Pack
CBL6264LED	32 White	Clear	1 Pc./Card



1966-67 Chevy II & Nova

68 LED One-Piece Style Tail Light

- 68 SMD LED tail light w/ high quality red polycarbonate lens
- Custom style on-piece design with backup light deleted
- Epoxy coated, fully sealed electronics, 1157 plug
- Energy efficient solid-state circuit board for 12V DC systems
- Recommend license plate with LED backup light, item # 50187
- Recommend to upgrade under dash flasher to item # 90652 or 90649 LED flasher

Item Number	LEDs	Lens	Pack
110359	68 Red	Red	1 Pc./Card

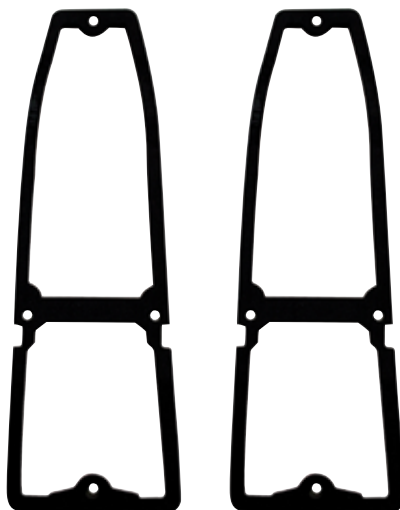

1968-69 Chevy Nova

36 LED Tail Light

- 36 super bright LEDs with high quality polycarbonate lens
- Dual function with tail light & bright stop/turn signal
- All red lens without backup light, fits L/H or R/H side
- Epoxy coated, fully sealed electronics, 1157 plug
- Recommend to upgrade under dash flasher to item # 90652 or 90649 LED flasher

Item Number	LEDs	Lens	Application	Pack
CTL6826LED	36 Red	Red	LH & RH	1 Pc./Card

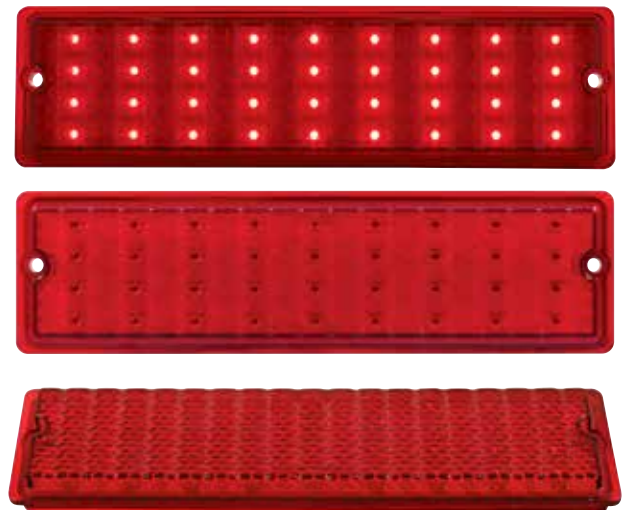

LED LIGHTS
1940s-50s CHEVY TRUCK

1940-53 Chevy & GMC Truck

Tail Light Lens Gasket

- Fits between the tail light housing and lens
- Made of quality cork-neoprene material as original
- Die cut to the exact shape and size as original to provide a nice tight seal

Item Number	Description	Package	Pack
C4009G	Tail Light Lens Gasket	Card	1 Pc./Card



1940-53 Chevy & GMC Truck

45 LED Tail Light Assembly

- 45 super bright red SMD LEDs with high quality polycarbonate lens
- Additional white LED with clear lens for license plate light
- Fully assembled gloss black or stainless steel die stamped metal housing with mounting studs
- Energy efficient solid-state circuit board for 12V DC systems
- Recommend to upgrade under dash flasher to item # 90652 or 90649 LED flasher

Item Number	Housing	Lens	Application	Pack
C7031RL	Black	Red	Driver	1 Pc./Card
C7031RR	Black	Red	Passenger	1 Pc./Card
C7033RL	Stainless	Red	Driver	1 Pc./Card
C7033RR	Stainless	Red	Passenger	1 Pc./Card

1940-53 Chevy & GMC Truck

27 LED Sequential Tail Light

- 27 super bright red LEDs with high quality polycarbonate lens
- Highly polished stainless steel housing
- Includes LED license illuminator lens with 6 bright white LEDs
- Features sequential function with selector switch to control sequential function off/on
- Also features brake attention option with sequence-once function
- Recommend to upgrade under dash flasher to item # 90652 or 90649 LED flasher

Item Number	LEDs	Lens	Application	Pack
110419	Red	Red	Driver	1 Pc./Box
110420	Red	Red	Passenger	1 Pc./Box



SEQUENTIAL F · L · A · S · H **BRAKE ATTENTION**

LED LIGHTS
1940s-50s CHEVY TRUCK

1940-53 Chevy Truck

23 LED Tail Light Assembly with LED Blue Dot

- 23 super bright red LEDs with LED blue dot, 6 white LEDs for license
- Available with black or stainless steel housing
- Blue dot can be controlled independently with additional wiring. For example, the blue dot can be turned-off, or be turned-on independently from Tail Light

Item Number	Housing	Lens	Application	Pack
C7031RLBD	Black	Red	Driver	1 Pc./Box
C7031RRBD	Black	Red	Passenger	1 Pc./Box
C7033RLBD	Stainless	Red	Driver	1 Pc./Box
C7033RRBD	Stainless	Red	Passenger	1 Pc./Box



1940-53 Chevy & GMC Truck

1937-38 Chevy Car

23 LED Tail Light Set w/ LED Blue Dot

- 23 super bright red LEDs with LED blue dot, 6 white LEDs for license
- Dual function with tail light and bright stop/turn signal
- Blue dot can be controlled independently with additional wiring
- High quality injection molded polycarbonate lens
- Epoxy coated, fully sealed electronics
- Energy efficient solid-state circuit board for 12V DC systems
- Set includes both L/H & R/H tail light lens, housing not included

Item Number	LEDs	Lens	Application	Pack
110750	Red	Red	L/H & R/H	1 Pair



1947-53 Chevy Truck

24 LED Parking and Turn Signal Light

- 24 super bright amber LEDs, complete with polycarbonate lens
- Dual function with parking light and bright turn signal
- Epoxy coated, fully sealed electronics, 1157 plug
- Gasket sold separately, item # C475308

Item Number	LEDs	Lens	Application	Pack
CPL4753A	24 Amber	Amber	Park/Turn	1 Pc./Card
CPL4753C	24 Amber	Clear	Park/Turn	1 Pc./Card



1947-53 Chevy Truck

24 LED Parking and Turn Signal Light Assembly

- Complete LED parking and turn signal light
- Polished stainless steel or chrome bezel with black housing
- 24 super bright amber LEDs, complete with polycarbonate lens
- Dual function with parking light and bright turn signal
- Epoxy coated, fully sealed electronics, 1157 plug

Item Number	Housing	LEDs	Lens	Pack
CPL4753A-AC	Chrome	24 Amber	Amber	1 Pc./Box
CPL4753C-AC	Chrome	24 Amber	Clear	1 Pc./Box
CPL4753A-AS	Stainless	24 Amber	Amber	1 Pc./Box
CPL4753C-AS	Stainless	24 Amber	Clear	1 Pc./Box



LED LIGHTS
1950s-60s CHEVY TRUCK

1960-66 Chevy Fleetside Truck

33 LED Parking Light

- 33 super bright LED parking light with polycarbonate lens
- Dual function with parking light & bright turn signal
- Fits L/H or R/H side
- Epoxy coated, fully sealed electronics, 1157 plug

Item Number	LEDs	Lens	Application	Pack
CPL6066A	33 Amber	Amber	Park/Turn	1 Pc./Card



1955-57 Chevy Truck

39 LED Parking Light

- 39 super bright LED parking light with polycarbonate lens
- Dual function with parking light & bright turn signal
- Easy electrical connection with 1157 plug, no modification to vehicle
- Lifetime warranty

Item Number	LEDs	Lens	Package	Pack
CPL5557A	39 Amber	Amber	Carded	1 Pc./Card
CPL5557C	39 Amber	Clear	Carded	1 Pc./Card



1951-53 GMC Truck

LED Parking Light Lens

- High quality polycarbonate replacement lens
- Excellent reproduction of the original design

Item Number	LEDs	Lens	Application	Pack
C515301	-	Clear	Parking	1 Pc./Bag



1951-53 GMC Truck

38 LED Parking Light

- 38 Amber LED parking light with clear lens
- Fits L/H or R/H side

Item Number	LEDs	Lens	Application	Pack
CPL5153C	38 Amber	Clear	LH & RH	1 Pc./Card



1958-59 Chevy & GMC Truck

41 LED Tail Light Lens

- 41 super bright red LEDs with high quality polycarbonate lens
- Epoxy coated, fully sealed electronics, 1157 plug
- Energy efficient solid-state circuit board for 12V DC systems
- Recommend to upgrade under dash flasher to item # 90652 or 90649 LED flasher

Item Number	LEDs	Lens	Application	Pack
CTL5859LED	41 Red	Red	Tail Light	1 Pc./Card
CTL5859C	41 Red	Clear	Tail Light	1 Pc./Card



LED LIGHTS
1950s-60s CHEVY TRUCK

1954-59 Chevy & GMC 2nd Series Stepside Truck

29 LED Sequential Tail Light

- 29 super bright red LEDs tail light with polycarbonate lens
- Features sequential operation with selector switch to select sequential left, sequential right, or sequential function off
- Also features brake attention option with sequence-once function
- Easy electrical connection with 1157 plug, no modification to vehicle
- Recommend to upgrade under dash flasher to item # 90652 or 90649 LED flasher

Item Number	LEDs	Lens	Application	Pack
110405	29 Red	Red	Tail light	1 Pc./Card



«« SEQUENTIAL »»
(((BRAKE)))
F · L · A · S · H ATTENTION

1954-59 Chevy & GMC Truck

29 LED Sequential Tail Light W/ Stainless Steel Housing

- 29 super bright red LED sequential tail light, with polished stainless steel housing and bezel
- Selector switch to control sequential function off, direction left, or direction right
- Also features brake attention option with sequence-once function
- Easy electrical connection w/ 1157 plug, no modification to vehicle
- Energy efficient solid-state circuit board for 12V DC systems
- Recommend to upgrade under dash flasher to item # 90652 or 90649 LED flasher

Item Number	LEDs	Lens	Application	Pack
110768	29 Red	Red	Tail Light	1 Pc./Card



«« SEQUENTIAL »»
(((BRAKE)))
F · L · A · S · H ATTENTION

1954-59 Chevy & GMC Truck

29 LED Tail Light

- 29 super bright red LEDs tail light with polycarbonate lens
- Easy electrical connection with 1157 plug, no modification to vehicle
- Recommend to upgrade under dash flasher to item # 90652 or 90649 LED flasher

Item Number	LEDs	Lens	Application	Pack
110404	29 Red	Red	Tail light	1 Pc./Card

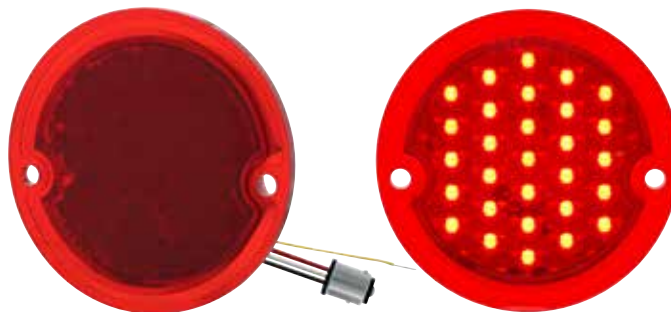

1955-59 Chevy Truck

Tail Light Lens Gasket

- Black foam rubber as original

Item Number	Description	Package	Pack
C555911-3	Tail Light Lens Gasket	Card	1 Pc./Card

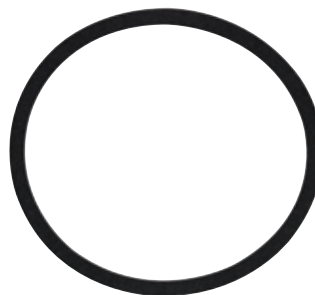

1954-59 Chevy & GMC Truck

29 LED Tail Light W/ Stainless Steel Housing

- 29 super bright red LED tail light with highly polished stainless steel housing
- Epoxy coated, fully sealed electronics, 1157 plug
- Energy efficient solid-state circuit board for 12V DC systems
- Recommend to upgrade under dash flasher to item # 90652 or 90649 LED flasher

Item Number	LEDs	Lens	Application	Pack
110766	29 Red	Red	Tail Light	1 Pc./Card



LED LIGHTS
1950s-60s CHEVY TRUCK

1954-59 Chevy & GMC Truck

29 LED Sequential Tail Light W/ Black Housing

- 29 super bright red LED sequential tail light with gloss black powder coated housing and polished stainless steel bezel
- Selector switch to control sequential function off, direction left, or direction right
- Also features brake attention option with sequence-once function
- Epoxy coated, fully sealed electronics, 1157 plug
- Upgrade under dash flasher to item # 90652 or 90649 LED flasher

Item Number	LEDs	Lens	Application	Pack
110767	29 Red	Red	Tail Light	1 Pc./Card



(((SEQUENTIAL))) ((BRAKE ATTENTION))

1954-59 Chevy & GMC Truck

29 LED Tail Light W/ Black Housing

- 29 super bright red LED tail light, with gloss black powder coated housing and polished stainless steel bezel
- Epoxy coated, fully sealed electronics, 1157 plug
- Recommend to upgrade under dash flasher to item # 90652 or 90649 LED flasher

Item Number	LEDs	Lens	Application	Pack
110765	29 Red	Red	Tail Light	1 Pc./Card



1960-66 Chevy Stepside Truck

41 LED Tail Light Assembly

- 41 super bright red LEDs with high quality polycarbonate lens
- Black or stainless steel housing, lens, gasket, socket & wiring
- Epoxy coated, fully sealed electronics, 1157 plug
- Energy efficient solid-state circuit board for 12V DC systems

Item Number	Housing	Lens	Application	Pack
CTL6066BR	Black	Red	Tail Light	1 Pc./Box
CTL6066BC	Black	Clear	Tail Light	1 Pc./Box
CTL6066SR	Stainless	Red	Tail Light	1 Pc./Box
CTL6066SC	Stainless	Clear	Tail Light	1 Pc./Box



1960-66 Chevy Stepside Truck

41 LED Tail Light

- 41 super bright red LEDs with high quality polycarbonate lens
- Epoxy coated, fully sealed electronics, 1157 plug
- Energy efficient solid-state circuit board for 12V DC systems
- Recommend to upgrade under dash flasher to item # 90652 or 90649 LED flasher

Item Number	LEDs	Lens	Application	Pack
CTL6066LED	41 Red	Red	Tail Light	1 Pc./Card
CTL6066C	41 Red	Clear	Tail Light	1 Pc./Card



LED LIGHTS

1960-66 CHEVY TRUCK



1960-66 Chevy & GMC Fleetside Truck

40 LED Sequential Tail Light Assembly

- 40 super bright red LEDs with high quality polycarbonate lens
- Features sequential function with selector switch to control sequential function off, direction left, or direction right
- Features sequence-once brake attention function
- OE style wiring with bullet terminal connectors
- Epoxy coated, fully sealed electronics
- Recommend to upgrade under dash flasher to item # 90652 or 90649 LED flasher

Item Number	LEDs	Lens	Application	Pack
110795	40 Red	Red	Tail Light	1 Pc./Card

1960-66 Chevy & GMC Fleetside Truck

40 LED Tail Light Assembly

- 40 super bright red LEDs with high quality polycarbonate lens
- Complete with housing, lens, gasket, socket & wiring
- Fully assembled, ready to install right out of the box
- Recommend to upgrade under dash flasher to item # 90652 or 90649 LED flasher

Item Number	LEDs	Lens	Application	Pack
CTL6066FSR	40 Red	Red	Tail Light	1 Pc./Card
CTL6066FSC	40 Red	Clear	Tail Light	1 Pc./Card



««« SEQUENTIAL »»»
(((BRAKE ATTENTION)))

1960-66 Chevy & GMC Fleetside Truck

40 LED Sequential Tail Light Assembly

- 40 super bright red LEDs with high quality polycarbonate lens
- Features sequential function with selector switch to control sequential function off, direction left, or direction right
- Also features sequence-once brake attention function
- Epoxy coated, fully sealed electronic, 1157 plug
- Recommend to upgrade under dash flasher to item # 90652 or 90649 LED flasher

Item Number	LEDs	Lens	Application	Pack
110199	40 Red	Red	Tail Light	1 Pc./Card



<<< SEQUENTIAL >>>
(((BRAKE ATTENTION)))

1960-66 Chevy & GMC Fleetside Truck

40 LED Tail Light Lens

- 40 super bright red LEDs with high quality polycarbonate lens
- Epoxy coated, fully sealed electronics, 1157 plug
- Energy efficient solid-state circuit board for 12V DC systems
- Recommend to upgrade under dash flasher to item # 90652 or 90649 LED flasher

Item Number	LEDs	Lens	Application	Pack
CTL6066FSLED	40 Red	Red	Tail Light	1 Pc./Card
CTL6066FC	40 Red	Clear	Tail Light	1 Pc./Card



1960-66 Chevy & GMC Fleetside Truck

40 LED Tail Light Lens

- 40 super bright red LEDs with high quality polycarbonate lens
- Epoxy coated, fully sealed electronics
- Easy wiring with hard wired 1157 double contact plug
- Energy efficient solid-state circuit board for 12V DC systems
- Recommend to upgrade under dash flasher to item # 90652 or 90649 LED flasher

Item Number	LEDs	Lens	Application	Pack
CTL6066FSLED	40 Red	Red	Tail Light	1 Pc./Card



1960-66 Chevy & GMC Fleetside Truck

Tail Light Lens Gasket (Pair)

- White foam rubber as original
- Die cut to the exact shape and size as original to provide nice a tight seal

Item Number	Description	Package	Pack
C606651	Tail Light Gasket	Carded	1 Pair

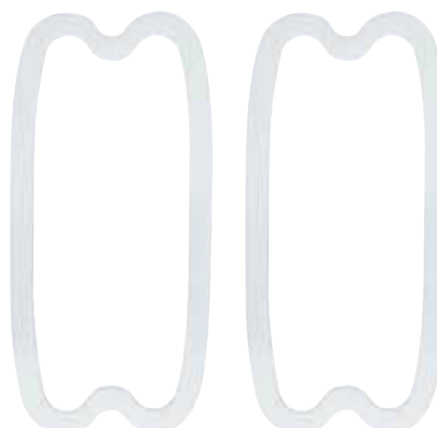

LED LIGHTS
C10 CHEVY TRUCK





LED LIGHTS
C10 CHEVY TRUCK

1967-72 Chevy & GMC Fleetside Truck

20 LED Sequential Tail Light Lens

- 20 super bright red LEDs with high quality polycarbonate lens
- Features sequential operation with selector switch to select sequential left, sequential right, or sequential function off
- Epoxy coated, fully sealed electronics, 1157 plug
- Energy efficient solid-state circuit board for 12V DC systems
- Upgrade under dash flasher to item # 90652 or 90649 LED flasher

Item Number	LEDs	Lens	Application	Pack
CTL6721SEQ	20 Red	Red	Tail Light	1 Pc./Card

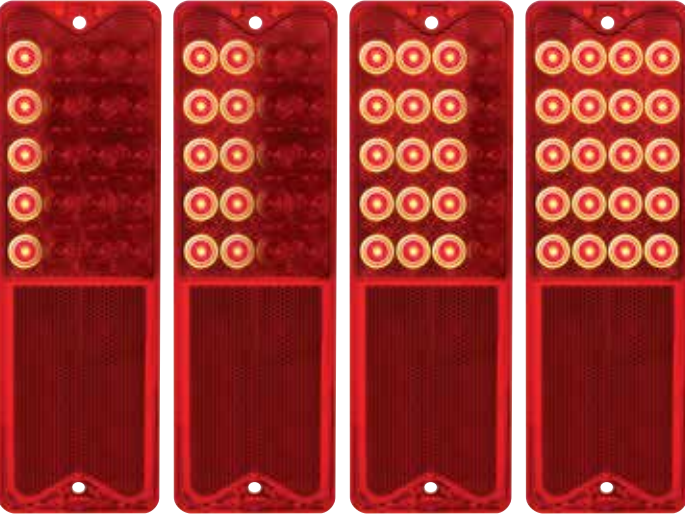

(((SEQUENTIAL)))
 F · L · A · S · H

(((BRAKE)))
 ATTENTION

1967-72 Chevy & GMC Fleetside Truck

20 LED Sequential & Non Sequential Tail Light Assembly

- 20 super bright red LEDs with high quality polycarbonate lens
- Features sequential operation with selector switch to select sequential left, sequential right, or sequential function off
- Epoxy coated, fully sealed electronics, 1157 plug
- Energy efficient solid-state circuit board for 12V DC systems
- Die stamped steel housing with mounting studs, socket, and gasket
- Recommend to upgrade under dash flasher to item # 90652 or 90649 LED flasher

Item Number	LEDs	Lens	Application	Pack
110214	20 RED	RED	Sequential	1 Pc./Card
110213	20 RED	RED	Non-Seq.	1 Pc./Card

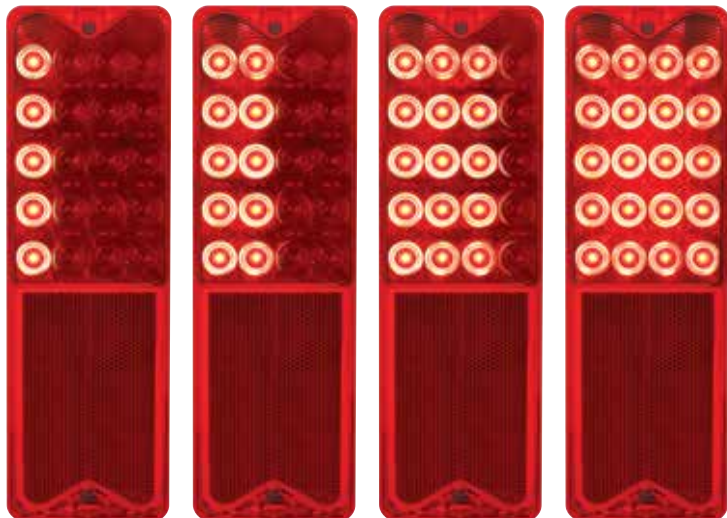

(((SEQUENTIAL)))
 F · L · A · S · H

(((BRAKE)))
 ATTENTION

1967-72 Chevy & GMC Truck

Tail Light Lens Gaskets (Pair)

- Fits between tail light housing and lens
- White foam rubber as original
- Die cut to the exact shape and size as original to provide a nice tight seal

Item Number	Description	Package	Pack
110215	Tail Light Lens Gasket	Carded	1 Pair



1967-72 Chevy Fleetside Truck

20 LED Tail Light Lens

- 20 super bright red LEDs with high quality polycarbonate lens
- Epoxy coated, fully sealed electronics, 1157 plug
- Energy efficient solid-state circuit board for 12V DC systems
- Recommend to upgrade under dash flasher to item # 90652 or 90649 LED flasher

Item Number	LEDs	Lens	Application	Pack
CTL6721LED	20 Red	Red	Tail Light	1 Pc./Card
CTL6721C	20 Red	Clear	Tail Light	1 Pc./Card

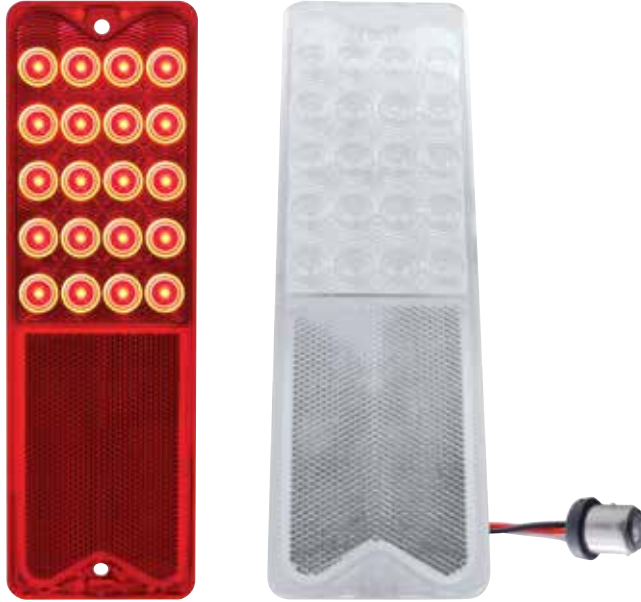

1967-72 Chevy & GMC Truck

30 LED Backup Light

- 30 super bright white LED bullseye lens
- Epoxy coated, fully sealed electronics, 1156 plug
- Energy efficient solid-state circuit board for 12V DC systems

Item Number	LEDs	Lens	Application	Pack
110200	30 White	Clear	Driver	1 Pc./Card
110201	30 White	Clear	Passenger	1 Pc./Card



1967-72 Chevy & GMC Truck

Backup Light Gasket (Pair)

- Fits between tail light housing and lens
- White foam rubber as original, die cut to the exact shape and size as original to provide a nice tight seal

Item Number	Description	Package	Pack
110202	Backup Light Gasket	Card	1 Pair



1967-72 Chevy & GMC Fleetside Truck

Tail Light Lens

- Great looking replacement lens (no GM markings)
- High quality injection molded polycarbonate lens
- Fits L/H or R/H

Item Number	LEDs	Lens	Application	Pack
C677209	-	Red	Tail Light	1 Pc./Card



1967-72 Chevy & GMC Suburban & Fleetside

61 Red LED Tail Light Insert

- 61 Super bright red LED circuit board installs behind existing lens
- Dual function with tail light & bright stop/turn signal
- Easy wiring with hard wired 1157 double contact plug, no modification to vehicle
- Mold to fit original housing, foam padding and tabs to secure
- Recommend to upgrade under dash flasher to item # 90652 or 90649 LED flasher

Item Number	LEDs	Lens	Application	Pack
110126	61	-	Tail Light	1 Pc./Card

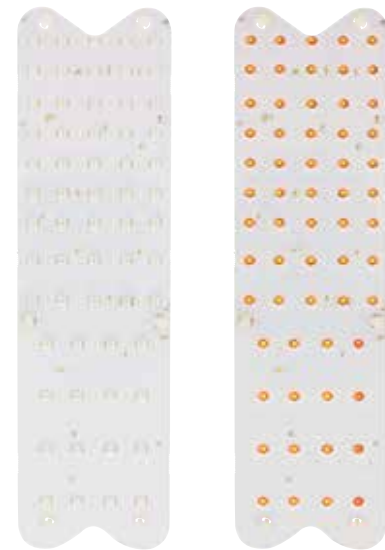

LED LIGHTS
C10 CHEVY TRUCK

1967-72 Chevy Stepside Truck

LED Tail Light

- 25 super bright red LEDs with high quality polycarbonate lens
- Epoxy coated, fully sealed electronics, 1157 plug
- Energy efficient solid-state circuit board for 12V DC systems
- Recommend to upgrade under dash flasher to item # 90652 or 90649 LED flasher

Item Number	LEDs	Lens	Application	Pack
CTL6772LED	25 Red	Red	Tail Light	1 Pc./Card



1973-87 Chevy & GMC Truck

20 LED Sequential Tail Light

- 20 Super bright red LEDs with high quality polycarbonate lens
- Features sequential operation with selector switch to select sequential left, sequential right, or sequential function off
- Also features brake attention option with sequence-once function
- Mounting base plate included
- Recommend to upgrade under dash flasher to item # 90652 or 90649 LED flasher

Item Number	LEDs	Lens	Application	Pack
CTL7387LED-L	20 Red	Red	Driver	1 Pc./Card
CTL7387LED-R	20 Red	Red	Passenger	1 Pc./Card



(((SEQUENTIAL)))
 F • L • A • S • H

(((BRAKE ATTENTION)))



1973-87 Chevy & GMC Truck

56 LED Sequential Tail Light With Trim

- 56 super bright red LED tail light with 12 LED white back-up light
- Features sequential operation with brake attention feature, selector switch to turn off if desired
- Special tail light mounting base plate included
- Electronics completely sealed in epoxy to resist corrosion and moisture
- Requires use of United Pacific LED turn signal flasher, item # 90652 or 90649

Item Number	LEDs	Lens	Application	Pack
110843	56 Red	Red	Driver	1 Pc./Card
110844	56 Red	Red	Passenger	1 Pc./Card



«« SEQUENTIAL »» (((BRAKE ATTENTION)))

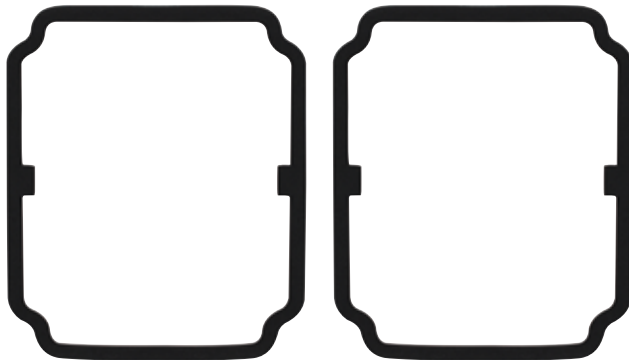

1973-87 Chevy & GMC Truck

Tail Light Lens Gasket (Pair)

- Black EVA foam
- Precision die cut to OE specifications for a perfect fit

Item Number	Description	Package	Pack
C738703	Tail Light Lens Gasket	Card	1 Pair

LED LIGHTS
C10 CHEVY TRUCK

1967-68 Chevy Truck

27 LED Parking Light Lens

- 27 super bright amber LEDs with high quality polycarbonate lens
- Dual function with parking light & bright turn signal
- Epoxy coated, fully sealed electronics, 1157 plug

Item Number	LEDs	Lens	Application	Pack
CPL6768A	27 Amber	Amber	Park/Turn	1 Pc./Card
CPL6768C	27 Amber	Clear	Park/Turn	1 Pc./Card

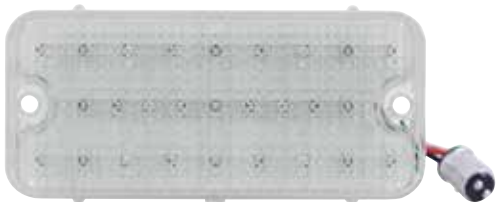
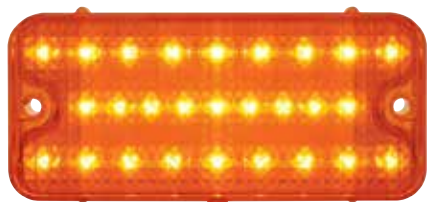

1969-70 Chevy Truck

36 LED Parking Light Lens

- 36 super bright amber LEDs, complete with polycarbonate lens
- Dual function with parking light & bright turn signal
- Epoxy coated, fully sealed electronics, 1157 plug
- Solid state circuit boards are designed for 7.7 - 14.0 VDC
- Recommend to upgrade to under dash flasher to item #90652 or 90649 LED flasher

Item Number	LEDs	Lens	Application	Pack
CPL6970AL	36 Amber	Amber	Driver	1 Pc./Card
CPL6970AR	36 Amber	Amber	Passenger	1 Pc./Card
CPL6970CL	36 Amber	Clear	Park/Turn	1 Pc./Card
CPL6970CR	36 Amber	Clear	Passenger	1 Pc./Card

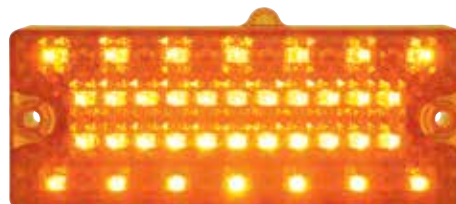
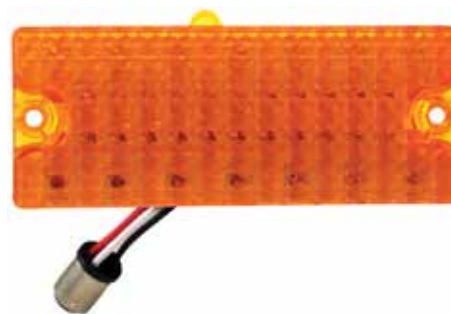

1971-72 Chevy Truck

34 LED Parking Light Lens

- 34 super bright LEDs with high quality injection molded polycarbonate lens, fits L/H or R/H
- Epoxy coated, fully sealed electronics, 1157 plug
- Recommend to upgrade to under dash flasher to item #90652 or 90649 LED flasher

Item Number	LEDs	Lens	Application	Pack
CPL7172A	34 Amber	Amber	LH & RH	1 Pc./Card
CPL7172C	34 Amber	Clear	LH & RH	1 Pc./Card

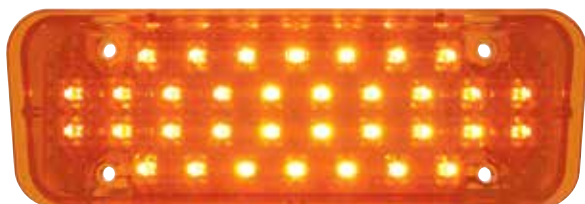



1968-72 Chevy Truck

18 LED Side Marker Light W/ Stainless Steel Trim

- 18 super bright LEDs with high quality polycarbonate lens
- Dual function, parking light and turn signal
- Identical to the original with deluxe stainless trim
- Epoxy coated, fully sealed electronics, 1157 plug
- Easy wiring with hard wired 1157 double contact plug
- Energy efficient solid-state circuit board for 12V DC systems

Item Number	LEDs	Lens	Application	Pack
CML6872A	18 Amber	Amber	Side Marker	1 Pc./Card
CML6872R	18 Red	Red	Side Marker	1 Pc./Card

1969-72 Chevy & GMC Truck

18 LED 3rd Brake & Cargo Light

- 18 super bright white LED cargo light with integrated 9 red LED 3rd brake light feature
- Plug & play with 1004 double contact plug as original
- 1004 double contact plug, straight pins
- Third brake light requires additional wiring, instructions included
- Epoxy coated, fully sealed electronics
- Energy efficient solid-state circuit board for 12V DC systems

Item Number	LEDs	Lens	Application	Pack
110127	18 White 9Red	Clear	Brake Light	1 Pc./Card



1973-80 Chevy & GMC Truck

15 LED Side Marker Light

- Polycarbonate lens with deluxe stainless steel trim
- Fits L/H or R/H side, sold individually

Item Number	LEDs	Lens	Application	Pack
CML7380A	15 Amber	Amber	L/H or R/H	1 Pc./Card
CML7380R	15 Red	Red	L/H or R/H	1 Pc./Card



LED LIGHTS
C10 CHEVY TRUCK



1969-72 Chevy & GMC Truck
LED Cargo Light Assembly

- Super bright LED cargo light assembly with integrated LED 3rd brake light
- High quality heavy chrome plated die-cast housing
- Includes large rubber mounting pad, socket, lens gasket, lens screws and housing to cab mounting spacers

Item Number	LEDs	Lens	Package	Pack
110147	White/Red	Clear	Carded	1 Pc./Card



LED LIGHTS
1928-34 FORD



LED LIGHTS
1928-32 FORD

1928-31 Ford Model A

LED Tail Light Lens W/ License Plate Light - 12V

- Super bright LED with high quality polycarbonate lens
- Drivers side includes LED license plate illuminator lens on bottom
- Epoxy coated, fully sealed electronics, two 1156 plugs
- Energy efficient solid-state circuit board for 12V DC systems
- Recommend to upgrade under dash flasher to item # 90652 or 90649 LED flasher

Item Number	LEDs	Lens	Application	Pack
FTL2831LED-L	19 Red 4 White	Red/Clear	Driver License	1 Pc./Card
FTL2831LED-R	19 Red	Red	Passenger	1 Pc./Card
FTL2831RA-L	12 Amber 7 Red 4 White	Amber/ Red/Clear	Driver License	1 Pc./Card
FTL2831RA-R	12 Amber 7 Red	Amber/Red	Passenger	1 Pc./Card



1928-31 Ford Model A

LED Tail Light W/ Stainless Steel Housing - 12V

- Super bright LEDs with high quality polycarbonate lens
- Complete with polished stainless steel housing and bezel
- Drivers side includes LED license plate illuminator lens on bottom
- Epoxy coated, fully sealed electronics, 1156 plug
- Energy efficient solid-state circuit board for 12V DC systems
- Recommend to upgrade under dash flasher to item # 90652 or 90649 LED flasher

Item Number	LEDs	Lens	Application	Pack
FTL2831LED-AL	19 Red 4 White	Red/Clear	Driver License	1 Pc./Box
FTL2831LED-AR	19 Red	Red	Passenger	1 Pc./Box
FTL2831RA-AL	12 Amber 7 Red 4White	Amber/ Red/Clear	Driver License	1 Pc./Card
FTL2831RA-AR	12 Amber 7 Red	Amber/Red	Passenger	1 Pc./Box



1928-31 Ford Model A

LED Tail Light Lens W/ License Plate Light- 6V

- Super bright LEDs with high quality polycarbonate lens
- Drivers side includes LED license plate illuminator lens on bottom
- Epoxy coated, fully sealed electronics, 1156 plug
- Energy efficient solid-state circuit board for 6V DC systems
- Recommend 6V flasher item # 110252, and load resistor kit 34235

Item Number	LEDs	Lens	Application	Pack
FTL2831LED6-L	19 Red 4 White	Red/Clear	Driver License	1 Pc./Card
FTL2831LED6-R	19 Red	Red	Passenger	1 Pc./Card
FTL2831RA6-L	12 Amber 7 Red 4 White	Amber/ Red/Clear	Driver License	1 Pc./Card
FTL2831RA6-R	12 Amber 7 Red	Amber/Red	Passenger	1 Pc./Card



1928-31 Ford Model A

LED Tail Light W/ Stainless Steel Housing - 6V

- Super bright LEDs with high quality polycarbonate lens
- Complete with polished stainless steel housing and bezel
- Drivers side includes LED license plate illuminator lens on bottom
- Epoxy coated, fully sealed electronics
- Energy efficient solid-state circuit board for 6V DC systems
- Recommend 6V flasher item # 110252, and load resistor kit 34235

Item Number	LEDs	Lens	Application	Pack
FTL2831LED6-AL	19 Red 4 White	Red/Clear	Driver License	1 Pc./Box
FTL2831LED6-AR	19 Red	Red	Passenger	1 Pc./Box
FTL2831RA6-AL	12 Amber 7 Red 4White	Amber/Red/ Clear	Driver License	1 Pc./Box
FTL2831RA6-AR	12 Amber 7 Red	Amber/Red	Passenger	1 Pc./Box



1928-31 Ford Model A

LED Tail Light W/ Black Housing - 12V

- Super bright LEDs with high quality polycarbonate lens
- Drivers side includes LED license plate illuminator lens on bottom
- Gloss black powder coated housing w/ polished stainless steel rim
- Epoxy coated, fully sealed electronics
- Energy efficient solid-state circuit board for 12V DC systems
- Recommend to upgrade under dash flasher to item # 90652 or 90649 LED flasher

Item Number	LEDs	Lens	Application	Pack
FTL2831LED-BAL	19 Red 4 White	Red/Clear	Driver License	1 Pc./Box
FTL2831LED-BAR	19 Red	Red	Passenger	1 Pc./Box
FTL2831RA-BAL	12 Amber 7 Red 4 White	Amber/ Red/Clear	Driver License	1 Pc./Box
FTL2831RA-BAR	12 Amber 7 Red	Amber/Red	Passenger	1 Pc./Box



1928-31 Ford Model A

LED Tail Light W/ Black Housing - 6V

- Super bright LEDs with high quality polycarbonate lens
- Drivers side includes LED license plate illuminator lens on bottom
- Gloss black powder coated housing w/ polished stainless steel rim
- Epoxy coated, fully sealed electronics
- Energy efficient solid-state circuit board for 6V DC systems
- Recommend 6V flasher item # 110252, and load resistor kit 34235

Item Number	LEDs	Lens	Application	Pack
FTL2831LED6-BAL	19 Red 4 White	Red/Clear	Driver License	1 Pc./Box
FTL2831LED6-BAR	19 Red	Red	Passenger	1 Pc./Box
FTL2831RA6-BAL	12 Amber 7 Red 4 White	Amber/ Red/Clear	Driver License	1 Pc./Box
FTL2831RA6-BAR	12 Amber 7 Red	Amber/Red	Passenger	1 Pc./Box



1928-31 Ford Model A

LED Tail Light With LED Blue Dot - 12V

- Super bright LEDs with high quality polycarbonate lens
- Unique center blue dot lens with chrome ring
- Drivers side includes LED license plate illuminator lens on bottom
- Blue dot can be controlled independently with additional wiring
- Epoxy coated, fully sealed electronics
- Energy efficient solid-state circuit board for 12V DC systems
- Recommend to upgrade under dash flasher to item # 90652 or 90649 LED flasher

Item Number	LEDs	Lens	Application	Pack
FTL2831BD-L	21 Red 4 White	Red/Clear	Driver License	1 Pc./Box
FTL2831BD-R	21 Red	Red	Passenger	1 Pc./Box



1928-31 Ford Model A

LED Tail Light With LED Blue Dot - 12V

- Super bright LEDs with high quality polycarbonate lens
- Drivers side includes LED license plate illuminator lens on bottom
- Blue dot can be controlled independently with additional wiring
- Epoxy coated, fully sealed electronics
- Energy efficient solid-state circuit board for 12V DC systems
- Recommend to upgrade under dash flasher to item # 90652 or 90649 LED flasher

Item Number	LEDs	Lens	Application	Housing
FTL2831BD-AL	21 Red 4 White	Red/Clear	Driver License	Stainless
FTL2831BD-AR	21 Red	Red	Passenger	Stainless
FTL2831BD-BAL	21 Red 4 White	Red/Clear	Driver License	Black
FTL2831BD-BAR	21 Red	Red	Passenger	Black



LED LIGHTS
1928-32 FORD

1928-31 Ford Car

31 LED Sequential Tail Light W/ Black Housing SS Rim

- 31 super bright LEDs behind high quality red acrylic lens
- 4 additional white LEDs with clear lens for license plate light
- Selector switch to control sequential function off, direction left, or direction right
- Also features brake attention option with sequence-once function
- Electronics sealed in epoxy to resist corrosion and moisture
- Energy efficient solid-state circuit board for 12V DC systems
- Recommend to upgrade under dash flasher to item # 90652 (2-terminal) or 90651 (3-terminal) LED flasher

Item Number	LEDs	Lens	Application	Pack
110894	31 Red 4 White	Red/Clear	Driver Side	1 Pc./Box
110895	31 Red	Red	Passenger Side	1 Pc./Box



««« SEQUENTIAL »»» (((BRAKE ATTENTION)))

1928-31 Ford Model "A"

31 LED Sequential Tail Light W/ Stainless Housing & Rim

- 31 bright LED sequential tail light w/ stainless steel housing & rim
- 4 additional white LEDs with clear lens for license plate light
- Selector switch to control sequential function off, direction left, or direction right
- Also features brake attention option with sequence-once function
- Electronics sealed in epoxy to resist corrosion and moisture
- Energy efficient solid-state circuit board for 12V DC systems
- Recommend to upgrade under dash flasher to item # 90652 (2-terminal) or 90651 (3-terminal) LED flasher

Item Number	LEDs	Lens	Application	Pack
110890	31 Red 4 White	Red/Clear	Driver Side	1 Pc./Box
110891	31 Red	Red	Passenger Side	1 Pc./Box



««« SEQUENTIAL »»» (((BRAKE ATTENTION)))

1928-31 Ford Car

31 LED Sequential Tail Light W/ Black Housing & Rim

- 31 super bright LED sequential tail light w/ black housing & rim
- 4 additional white LEDs with clear lens for license plate light
- Selector switch to control sequential function off, direction left, or direction right
- Also features brake attention option with sequence-once function
- Electronics sealed in epoxy to resist corrosion and moisture
- Energy efficient solid-state circuit board for 12V DC systems
- Recommend to upgrade under dash flasher to item # 90652 (2-terminal) or 90651 (3-terminal) LED flasher

Item Number	LEDs	Lens	Application	Pack
110892	31 Red 4 White	Red/Clear	Driver Side	1 Pc./Box
110893	31 Red	Red	Passenger Side	1 Pc./Box



««« SEQUENTIAL »»» (((BRAKE ATTENTION)))

1928-31 Ford Car

19 LED Tail Light - Stainless Steel Housing & Rim

- 19 super bright LEDs with polished stainless steel housing & rim
- 4 additional white LEDs with clear lens for license plate light
- Electronics sealed in epoxy to resist corrosion and moisture
- Energy efficient solid-state circuit board for 12V DC systems
- Recommend to upgrade under dash flasher to item # 90652 (2-terminal) or 90651 (3-terminal) LED flasher

Item Number	LEDs	Lens	Application	Pack
FTL2831LED-AL	19 Red 4 White	Red/Clear	Driver Side	1 Pc./Box
FTL2831LED-AR	19 Red	Red	Passenger Side	1 Pc./Box



1928-31 Ford Model "A"

LED Tail Light W/ Black Housing & Blue Dot Lens

- Super bright red LEDs w/ gloss black powder coated housing & rim
- 4 additional white LEDs with clear lens for license plate light
- Blue dot with chrome plated ring looks exactly as original
- Blue dot can be controlled independently with additional wiring
- Electronics sealed in epoxy to resist corrosion and moisture
- Energy efficient solid-state circuit board for 12V DC systems
- Recommend to upgrade under dash flasher to item # 90652 (2-terminal) or 90651 (3-terminal) LED flasher

Item Number	LEDs	Lens	Application	Pack
FTL2831BD-MAL	19 Red 4 White	Red/Clear	Driver Side	1 Pc./Box
FTL2831BD-MAR	19 Red	Red	Passenger Side	1 Pc./Box



1932 Ford Car & Truck

31 LED Sequential Tail Light W/ Stainless Housing & Rim

- 31 super bright LED sequential tail light w/ highly polished stainless steel housing & rim
- 4 additional white LEDs with clear lens for license plate light
- Selector switch to control sequential function off, direction left, or direction right
- Also features brake attention option with sequence-once function
- Electronics sealed in epoxy to resist corrosion and moisture
- Energy efficient solid-state circuit board for 12V DC systems
- Recommend to upgrade under dash flasher to item # 90652 or 90649 LED flasher

Item Number	LEDs	Lens	Application	Pack
110873	31 Red	Red	Driver	1 Pc./Box
110872	31 Red	Red	Passenger	1 Pc./Box



LED LIGHTS
1928-34 FORD

1928 Ford Model "A"

LED Tail Lights - Horizontal

- Bobby style LED 1928 Ford Model "A" tail light w/ LED license light
- Bright red LEDs with red glass lens and black license bracket
- Perfect for custom motorcycles

Item Number	LEDs	Lens	Rim/Housing	Pack
86819	19 Red 4 White	Red/Clear	Black/Black	1 Pc./Box
86817	19 Red 4 White	Red/Clear	Stainless Steel/ Black	1 Pc./Box
86815	19 Red 4 White	Red/Clear	Stainless Steel	1 Pc./Box



86819



86817



86815

1928 Ford Model "A"

LED Tail Lights - Vertical

- Bobby style LED 1928 Ford Model "A" tail light w/ LED license light
- Bright red LEDs with red glass lens and black license bracket
- Perfect for custom motorcycles

Item Number	LEDs	Lens	Rim/Housing	Pack
86844	19 Red 4 White	Red/Clear	Black/Black	1 Pc./Box
86842	19 Red 4 White	Red/Clear	Stainless Steel/ Black	1 Pc./Box
86840	19 Red 4 White	Red/Clear	Stainless Steel	1 Pc./Box



86844



86842



86840

1932 Ford

LED Tail Light - Horizontal W/ Stainless Rim & Housing

- Bobby style LED 1932 Ford tail light w/ LED license light
- Bright red LEDs with red glass lens and black license bracket
- Perfect for custom motorcycles

Item Number	LEDs	Lens	Rim/Housing	Pack
86821	19 Red 4 White	Red/Clear	Stainless Steel	1 Pc./Box



1932 Ford

LED Tail Light - Vertical W/ Stainless Rim & Housing

- Bobby style LED 1932 Ford tail light w/ LED license light
- Bright red LEDs with red glass lens and black license bracket
- Perfect for custom motorcycles

Item Number	LEDs	Lens	Rim/Housing	Pack
86846	19 Red 4 White	Red/Clear	Stainless Steel/ Black	1 Pc./Box



1933 Ford

LED Tail Lights - Horizontal

- Bobby style LED 1933 Ford tail light w/ LED license light
- Bright red LEDs with red glass lens and black license bracket
- Perfect for custom motorcycles

Item Number	LEDs	Lens	Rim/Housing	Pack
86824	19 Red 4 White	Red/Clear	Black/Black	1 Pc./Box
86823	19 Red 4 White	Red/Clear	Stainless Steel/ Black	1 Pc./Box



86824



86823

1933 Ford

LED Tail Lights - Vertical

- Bobby style LED 1933 Ford tail light w/ LED license light
- Bright red LEDs with red glass lens and black license bracket
- Perfect for custom motorcycles

Item Number	LEDs	Lens	Rim/Housing	Pack
86849	19 Red 4 White	Red/Clear	Stainless Steel/ Black	1 Pc./Box
86848	19 Red 4 White	Red/Clear	Stainless Steel	1 Pc./Box



86849

86848

LED LIGHTS
1928-34 FORD

Ford LED Cowl Light

- Ford LED cowl light, dual function, parking light and turn signal light
- Hardwired with 3 wires, 1 wire with ring terminal, 12V
- Solid state circuit boards are designed for 7.7 - 14.0 VDC

Fits 1928-1929 Ford

Item Number	LEDs	Lens	Application	Pack
FPL2829LED	22 Amber	Clear	Carded	1 Pc./Card

Fits 1930-1931 Ford

Item Number	LEDs	Lens	Application	Pack
FPL3031LED	17 Amber	Clear	Carded	1 Pc./Card

Fits 1932 Ford

Item Number	LEDs	Lens	Application	Pack
FPL3232LED	15 Amber	Clear	Carded	1 Pc./Card

Fits 1933-1934 Ford

Item Number	LEDs	Lens	Application	Pack
FPL3334LED	13 Amber	Clear	Carded	1 Pc./Card



FPL2829LED - 1928-29 Ford



FPL3031LED - 1930-31 Ford



FPL3232LED - 1932 Ford



FPL3334LED - 1933-34 Ford

1932 Ford Car & Truck

Polished Stainless Steel Spreader Bar w/ LED Turn Signals

- Highly polished stainless steel with hidden welds
- Wires exit on each side near mounting flange and can be easily hidden along inside frame rail
- Flush mounted amber lens LED lights
- Each light strip has 10 super bright amber LED lights to function as turn signal light
- High quality polycarbonate lens with epoxy coated fully sealed 12V DC solid state circuit boards
- Recommend to upgrade under dash flasher to item # 90652 or 90649 LED flasher

Item Number	LEDs	Lens	Application	Pack
F3201LED	5 Amber x 2	Amber	Spreader	1 Pc./Box

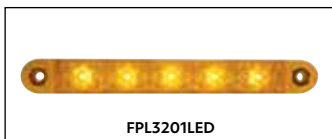
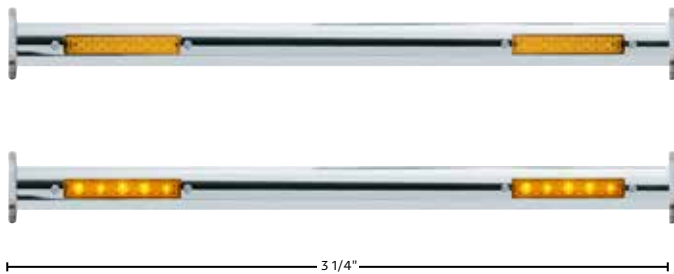

Directly Fits All 1928 - 1934 Ford Cowl Lamps



1933-34 Ford Car & Truck

SS Front V-Shape Spreader Bar With LED

- Highly polished stainless steel with hidden welds
- Wires exit on each side near mounting flange and can be easily hidden along inside frame rail
- Flush mounted amber lens LED lights
- Each light strip has 10 super bright amber LED light to function as turn signal light
- High quality polycarbonate lens with epoxy coated fully sealed 12V DC solid state circuit boards
- Recommend to upgrade under dash flasher to item # 90652 or 90649 LED flasher

Item Number	LEDs	Lens	Application	Pack
F3301-LED	5 Amber x 2	Amber	Spreader	1 Pc./Box

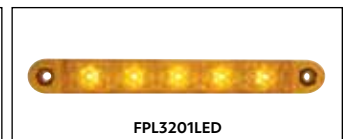
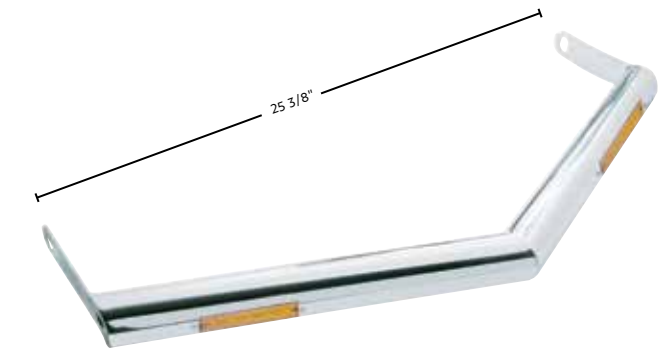



1932 Ford Car & Truck

17 LED Tail Light Lens

- 17 super bright LEDs, driver side includes a 4 white LED license light
- Epoxy coated, fully sealed electronics, two 1156 plugs
- Solid state circuit boards are designed for 7.7 - 14.0 VDC

Item Number	LEDs	Lens	Application	Pack
FTL3201LED-L	17 Red/4 Wht.	Red/Clear	Driver	1 Pc./Card
FTL3201LED-R	17 Red	Red	Passenger	1 Pc./Card

1928-31 Ford Car

31 LED Sequential Tail Light

- 31 bright LEDs, driver side includes a 4 white LED license light
- Selector switch to control sequential function off, direction left, or direction right
- Also features brake attention with a sequence-once function
- Epoxy coated, fully sealed electronics, two 1156 plugs
- Recommend to upgrade under dash flasher to item # 90652 or 90649 LED flasher
- DOT & SAE FMVSS108. Not for use w/early 1928 "AR" drum tail lights

Item Number	LEDs	Lens	Application	Pack
110194	31 Red/4 Wht.	Red/Clear	Driver	1 Pc./Card
110195	31 Red	Red	Passenger	1 Pc./Card

1932 Ford Car & Truck

34 LED Sequential Tail Light

- 34 bright LEDs, driver side includes a 4 white LED license light
- Selector switch to control sequential function off, direction left, or direction right
- Also features brake attention with a sequence-once function
- Epoxy coated, fully sealed electronics, two 1156 plugs
- Energy efficient solid-state circuit board for 12VDC systems
- Recommend to upgrade under dash flasher to item # 90652 or 90649 LED flasher

Item Number	LEDs	Lens	Application	Pack
110196	34 Red/4 Wht.	Red/Clear	Driver	1 Pc./Card
110197	34 Red	Red	Passenger	1 Pc./Card

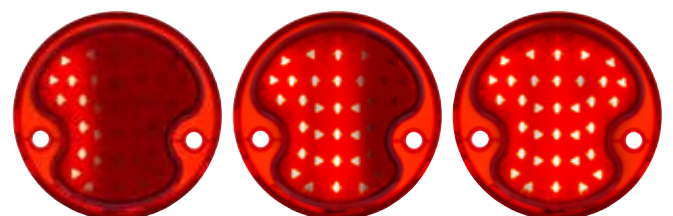

(((SEQUENTIAL)))
F • L • A • S • H (((BRAKE)))
ATTENTION

(((SEQUENTIAL)))
F • L • A • S • H (((BRAKE)))
ATTENTION

LED LIGHTS
1930s-40s FORD

1932 Ford Car & Truck

17 LED Tail Light Assembly W/ Stainless Housing

- 17 super bright LEDs with high quality polycarbonate lens
- Complete with polished stainless steel housing and bezel
- Includes bright LED license plate illuminator lens on bottom
- Electronics sealed in epoxy to resist corrosion and moisture
- Energy efficient solid-state circuit board for 12V DC systems
- Recommend to upgrade under dash flasher to item # 90652 or 90649 LED flasher

Item Number	LEDs	Lens	Application	Pack
FTL3201LED-AL	17 Red/4 Wht.	Red/Clear	Driver	1 Pc./Box
FTL3201LED-AR	17 Red	Red	Passenger	1 Pc./Box



1933-36 Ford Car & Truck

21 LED Tail Light Assembly

- 21 super bright LEDs with high quality polycarbonate lens
- Polished stainless steel housing
- Includes bright LED license plate illuminator lens on bottom
- Epoxy coated, fully sealed electronics
- Easy wiring with hard wired 1157 double contact plug
- Recommend to upgrade under dash flasher to item # 90652 or 90649 LED flasher

Item Number	LEDs	Lens	Application	Housing
FTL3336LED-AL	17 Red 4 White	Red/Clear	Driver License	Stainless
FTL3336LED-AR	17 Red	Red	Passenger	Stainless
FTL3336LED-ALB	17 Red 4 White	Red/Clear	Driver License	Black
FTL3336LED-ARB	17 Red	Red	Passenger	Black



1933-36 Ford Car & Truck

19 LED Tail Light Assembly - Glass Lens

- 19 super bright LEDs with high quality polycarbonate lens
- Epoxy coated, fully sealed electronics
- Solid-state circuit board engineered for 12V DC systems
- Recommend to upgrade under dash flasher to item # 90652 or 90649 LED flasher

Item Number	LEDs	Lens	Application	Housing
FTL3336L	19 Red 5 White	Red/Clear	Driver License	Stainless
FTL3336R	19 Red	Red	Passenger	Stainless
FTL3336L-BK	19 Red 5 White	Red/Clear	Driver License	Black
FTL3336R-BK	19 Red	Red	Passenger	Black



1933-36 Ford Truck

17 LED Tail Light With Chrome Grille Bezel

- Great for hot rods, rat rods, and motorcycles
- Chrome plated die-cast metal grille bezel protects tail light lens
- Includes LED license plate illuminator with lens
- Solid-state circuit board engineered for 12V DC systems

Item Number	LEDs	Lens	Application	Pack
110660	17 Red 4 White	Red	Driver License	1 Pc./Card
110661	17 Red	Red	Passenger	1 Pc./Card



1937 Ford Car

17 LED Tail Light W/Chrome Grille Bezel Flush Mount Style

- 17 super bright red LEDs with chrome flush mount bezel
- Light is 3-3/4" dia. and 3/4" tall
- Mounting studs are approximately 3-7/16" apart
- Recommend to upgrade under dash flasher to item # 90652 or 90649 LED flasher

Item Number	LEDs	Lens	Application	Pack
110407	17 Red	Red	Tail light	1 Pc./Card



1933-36 Ford Truck

17 LED Tail Light W/ Black Grille Bezel

- Great for hot rods, rat rods, and motorcycles
- Gloss black powder coated metal grille bezel protects tail light lens
- High quality polycarbonate all red lens
- Includes LED license plate illuminator with lens
- Solid-state circuit board engineered for 12V DC systems

Item Number	LEDs	Lens	Application	Pack
110662	17 Red 4 White	Red	Driver License	1 Pc./Card
110663	17 Red	Red	Passenger	1 Pc./Card



1937 Ford Car

17 LED Tail Light W/Black Grille Bezel Flush Mount Style

- 17 super bright red LEDs with black powder coated flush mount bezel
- Light is 3-3/4" dia. and 3/4" tall
- Mounting studs are approximately 3-7/16" apart
- Recommend to upgrade under dash flasher to item # 90652 or 90649 LED flasher

Item Number	LEDs	Lens	Application	Pack
110409	17 Red	Red	Tail light	1 Pc./Card



1933-36 Ford Car & Truck

21 LED Tail Light

- 21 super bright LEDs with injection molded polycarbonate lens
- Includes bright LED license plate illuminator lens on bottom
- Epoxy coated, fully sealed electronics, 1157 plug
- Solid-state circuit board engineered for 12V DC systems
- Recommend to upgrade under dash flasher to item # 90652 or 90649 LED flasher

Item Number	LEDs	Lens	Application	Pack
FTL3336LED-L	17 Red 4 White	Red/Clear	Driver License	1 Pc./Card
FTL3336LED-R	17 Red	Red	Passenger	1 Pc./Card

LED LIGHTS
1930s-40s FORD

1937 Ford Car & Truck

17 LED Tail Light Lens

- 17 super bright LED with high quality polycarbonate lens
- Includes bright LED license plate illuminator lens on bottom
- Epoxy coated, fully sealed electronics, 1157 plug
- Energy efficient solid-state circuit board for 12V DC systems
- Recommend to upgrade under dash flasher to item # 90652 or 90649 LED flasher

Item Number	LEDs	Lens	Application	Pack
FTL3701LED-L	17 Red 8 White	Red/Clear	Driver License	1 Pc./Card
FTL3701LED-R	17 Red	Red	Passenger	1 Pc./Card



1937 Ford Car & Truck

17 LED Tail Light

- 17 super bright LED with high quality polycarbonate lens
- Beautiful chrome plated housing and polished stainless steel rim
- Epoxy coated, fully sealed electronics
- Energy efficient solid-state circuit board for 12V DC systems
- Recommend to upgrade under dash flasher to item # 90652 or 90649 LED flasher

Item Number	LEDs	Lens	Application	Pack
FTL3711RC	17 Red	Red	Passenger	Chrome
FTL3711L	17 Red 6 White	Red/Clear	Driver License	Black
FTL3711R	17 Red	Red	Passenger	Black



1933-36 Ford Car & Truck

19 LED Tail Light Retrofit

- 19 super bright LEDs with high quality polycarbonate lens
- Epoxy coated, fully sealed electronics
- Solid-state circuit board engineered for 12V DC systems
- Recommend to upgrade under dash flasher to item # 90652 or 90649 LED flasher

Item Number	LEDs	Lens	Application	Pack
FTL3336CB-L	19 Red 5 White	Red/Clear	Driver License	1 Pc./Card
FTL3336CB-R	19 Red	Red	Passenger	1 Pc./Card



1933-36 Ford Car & Truck

21 LED Tail Light With Smoke Lens

- 21 super bright LEDs with high quality polycarbonate lens
- Includes 4 bright white LED license light
- Epoxy coated, fully sealed electronics, 1157 plug
- Solid-state circuit board engineered for 12V DC systems
- Recommend to upgrade under dash flasher to item # 90652 or 90649 LED flasher

Item Number	LEDs	Lens	Application	Pack
110150	21 Red 4 White	Clear	Driver License	1 Pc./Card



1938-39 Ford Car

33 LED Tail Light Lens

- 33 super bright LED tail light with red polycarbonate lens
- Dual function with parking light and bright turn signal
- Lens fits all original & reproduction 1938-39 Ford tail lights
- Easy electrical connection w/ 1157 plug, no modification to vehicle
- Fits L/H or R/H side
- Recommend to upgrade under dash flasher to item # 90652 (2-terminal or 90651 (3-terminal)

Item Number	LEDs	Lens	Package	Pack
FTL3839NTLED	33 Red	Red	Carded	1 Pc./Card

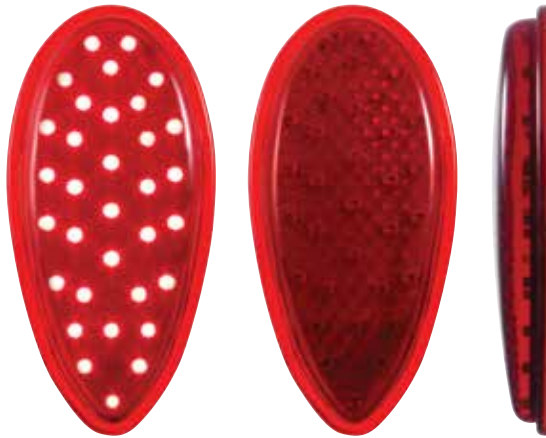

1938-39 Ford Car

33 LED Tail Light W/ Stainless Steel Rim

- 33 super bright LED tail light with red polycarbonate lens
- Dual function with tail light & bright stop/turn signal
- Epoxy coated, fully sealed electronics, 1157 plug
- Original style black tail lamp housing with stainless steel rim
- Rubber mounting pad sold separately, item # A9009
- Recommend to upgrade under dash flasher to item # 90652 or 90649 LED

Item Number	LEDs	Lens	Package	Pack
F383904	33 Red	Red	Boxed	1 Pc./Box



1938-39 Ford Car

33 LED Tail Light W/ Chrome Flush Mount Bezel

- 33 super bright LED tail light with red polycarbonate lens
- Dual function with tail light and bright stop/turn signal
- Die-cast chrome plated bezel, mounts to flat surface with 2 small studs, fits L/H or R/H side
- Epoxy coated, fully sealed electronics, 1157 plug
- Rubber mounting pad sold separately, item # FTL3839-1
- Recommend to upgrade under dash flasher to item # 90652 or 90649 LED

Item Number	LEDs	Lens	Package	Pack
FTL383907	33 Red	Red	Carded	1 Pc./Card



1938-39 Ford Car

28 LED Tail light With Glass Lens

- 28 super bright red LED behind glass lens
- Epoxy coated, fully sealed electronics
- Includes stainless steel rim and black housing
- Recommend to upgrade under dash flasher item # 90652 or 90649 LED flasher

Item Number	LEDs	Lens	Package	Pack
A1060LED	28 Red	Red	Carded	1 Pc./Box



LED LIGHTS
1930s-40s FORD

1938-39 Ford Car

51 LED Tail Light

- 51 super bright red LEDs w/ high quality polycarbonate lens
- Epoxy coated, fully sealed electronics
- Easy electrical connection w/ 1157 plug, no modification to vehicle
- Energy efficient solid-state circuit board for 12V DC systems
- Recommend to upgrade under dash flasher to item # 90652 or 90649 LED

Item Number	LEDs	Lens	Package	Pack
FTL3839LED	51 Red	Red	Carded	1 Pc./Card



1938-39 Ford Car

51 LED Tail Light With Stainless Steel Rim

- 51 super bright red LEDs w/ high quality polycarbonate lens
- Epoxy coated, fully sealed electronics
- Includes stainless steel rim and black housing
- Energy efficient solid-state circuit board for 12V DC systems
- Recommend to upgrade under dash flasher to item # 90652 or 90649 LED

Item Number	LEDs	Lens	Package	Pack
F383901	51 Red	Red	Carded	1 Pc./Card



1938-39 Ford Passenger Car

19 LED Sequential Tail Light Lens

- 19 super bright red LED sequential tail light
- Selector switch to control sequential function off, direction left, or direction right
- Also features brake attention option with sequence-once function
- Epoxy coated, fully sealed electronics, 1157 plug
- Recommend to upgrade under dash flasher to item # 90652 or 90649 LED
- Fits United Pacific chrome teardrop bezel: item # 34024B and flame bezel item # 34025B, DOT/SAE approved

Item Number	LEDs	Lens	Package	Pack
110253	19 Red	Red	Carded	1 Pc./Card

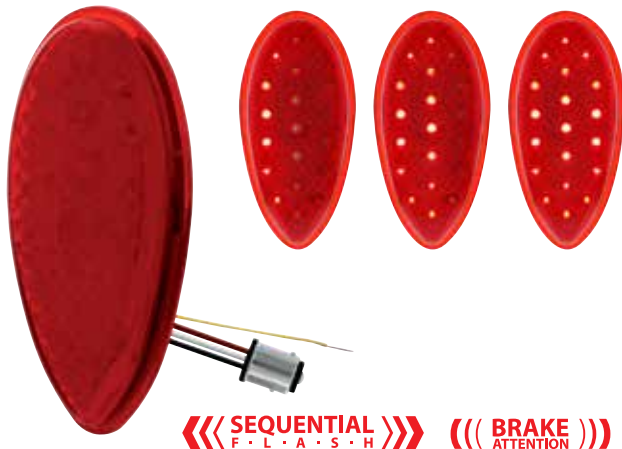

<<< SEQUENTIAL >>>
(((BRAKE)))
F.L.A.S.H
ATTENTION

1938-39 Ford Car

19 LED Sequential Tail Light Assembly

- 19 super bright red LED sequential tail light
- Black powder coated housing, stainless steel rim
- Selector switch to control sequential function off, direction left, or direction right
- Also features brake attention option with sequence-once function
- Epoxy coated, fully sealed electronics, 1157 plug
- Recommend to upgrade under dash flasher to item # 90652 or 90649 LED

Item Number	LEDs	Lens	Package	Pack
110796	19 Red	Red	Carded	1 Pc./Card

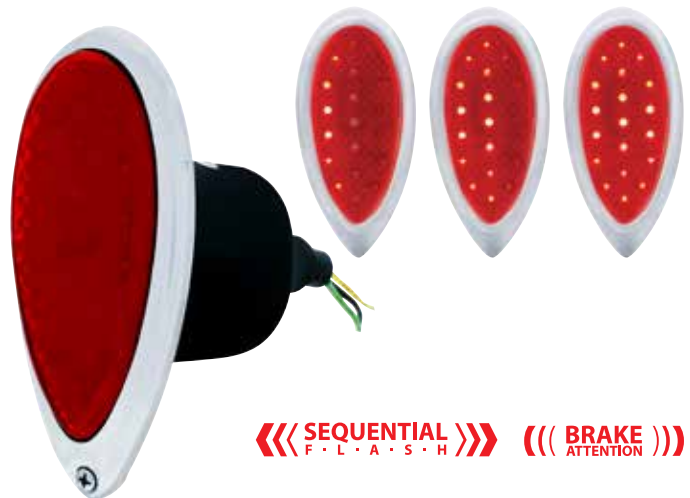

<<< SEQUENTIAL >>>
(((BRAKE)))
F.L.A.S.H
ATTENTION

1938-39 Ford Car

19 LED Sequential Tail Light w/Chrome Bezel - Flush Mount

- 19 bright LED sequential tail light with chrome flush mount bezel
- Selector switch to control sequential function off, direction left, or direction right
- Also features brake attention option with sequence-once function
- Epoxy coated, fully sealed electronics, 1157 plug
- Chrome plastic flame bezel, mounts with 2 small studs
- Recommend to upgrade under dash flasher to item # 90652 or 90649 LED

Item Number	LEDs	Lens	Package	Pack
110797	19 Red	Red	Carded	1 Pc./Card

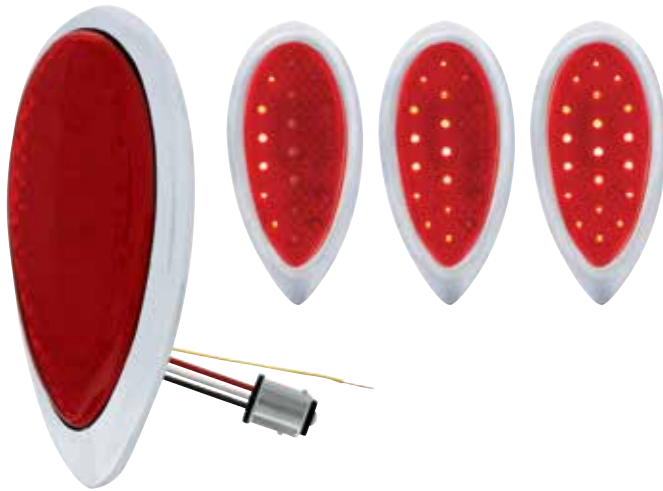

(((SEQUENTIAL)))
F · L · A · S · H

(((BRAKE ATTENTION)))

1938-39 Ford Car

39 LED Tail Light W/ Flush Mount Chrome Bezel

- 39 super bright LEDs w/ high quality polycarbonate lens
- Die-cast chrome plated bezel mounts to flat surface w/ 2 small studs
- Epoxy coated, fully sealed electronics, 1157 plug
- Energy efficient solid-state circuit board for 12V DC systems
- Mounting pad sold separately item # FTL3839-1
- Recommend to upgrade under dash flasher to item # 90652 or 90649 LED

Item Number	LEDs	Lens	Housing	Pack
FTL383903	39 Red	Red	Chrome	1 Pc./Card



1938-39 Ford Car

37 LED Tail Light W/ Stainless Steel Bezel

- 37 super bright LED tail light with high quality polycarbonate lens
- Stainless steel rim and black original style housing
- Epoxy coated, fully sealed electronics, 1157 plug
- Recommend to upgrade under dash flasher to item # 90652 or 90649 LED
- Mounting pad item # A9009 sold separately

Item Number	LEDs	Lens	Housing	Pack
F383905	37 Red/14 Amber	Clear	Chrome	1 Pc./Card



1938-39 Ford Car

37 LED Tail Light W/ Stainless Steel Bezel

- 37 super bright LED tail light w/ high quality polycarbonate lens
- High quality injection molded polycarbonate lens
- Epoxy coated, fully sealed electronics
- Easy electrical connection w/ 1157 plug, no modification to vehicle
- Recommend to upgrade under dash flasher to item # 90652 or 90649 LED

Item Number	LEDs	Lens	Housing	Pack
FTL383905ZR	37 Red/14 Amber	Clear	Chrome	1 Pc./Card



LED LIGHTS
1930s-40s FORD

1938-39 Ford Car

51 LED Tail Light W/Flush Mount "Baby Zephyr" Bezel

- 51 super bright LED tail light with high quality polycarbonate lens
- Baby Zephyr style bezel with over-the-lens cross bar
- Die-cast chrome plated bezel mounts to flat surface w/ 2 small studs
- Epoxy coated, fully sealed electronics, 1157 plug
- Energy efficient solid-state circuit board for 12V DC systems
- Recommend to upgrade under dash flasher to item # 90652 or 90649 LED

Item Number	LEDs	Lens	Housing	Pack
FTL383903ZR	51 Red/14 Amber	Clear	Chrome	1 Pc./Card



1938-39 Ford Car

33 LED Tail Light Lens - Original Style

- 33 super bright LED tail light with red polycarbonate lens
- New LED lens design is the same size and shape as original Ford lens
- Dual function with tail light and bright turn signal
- Blue dot can be controlled independently with additional wiring
- Lens fits all original & reproduction 1938-39 Ford tail lights
- Easy wiring with hard wired 1157 double contact plug, no modification to vehicle, fits L/H or R/H side
- Recommend to upgrade under dash flasher to item # 90652 or 90649 LED

Item Number	LEDs	Lens	Package	Pack
FTL3839NT-BD	33 Red	Red	Carded	1 Pc./Card



1938-39 Ford Car

33 LED Tail Light W/Blue Dot Lens & Stainless Steel Bezel

- 33 super bright LED tail light with red polycarbonate lens
- Blue dot with chrome plated rim looks exactly as original
- Stamped steel housing with polished stainless rim
- Dual function with tail light and bright turn signal
- Blue dot can be controlled independently with additional wiring
- Rubber mounting pad sold separately, item # A9009
- Recommend to upgrade under dash flasher to item # 90652 or 90649 LED

Item Number	LEDs	Lens	Package	Pack
F383904BD	33 Red	Red	Carded	1 Pc./Card



1938-39 Ford Car

33 LED Tail Light W/ Chrome Bezel & Blue Dot, Flush Mount

- 33 super bright LED flush mount tail light with polycarbonate lens
- Blue dot with chrome plated rim looks exactly as original
- Dual function with tail light and bright turn signal
- Blue dot can be controlled independently with additional wiring
- Die-cast chrome plated bezel, mounts to flat surface with 2 studs
- Epoxy coated, fully sealed electronics, 1157 plug
- Recommend to upgrade under dash flasher to item # 90652 or 90649 LED

Item Number	LEDs	Lens	Package	Pack
FTL383908	33 Red	Red	Carded	1 Pc./Card



1938-39 Ford Car

LED Tail Light w/ Chrome Bezel

- 37 super bright LED tail light with dual color polycarbonate lens
- Chrome flush mount "Teardrop" style bezel
- Epoxy coated, fully sealed electronics, 1157 plug
- Recommend to upgrade under dash flasher to item # 90652 or 90649 LED

Item Number	LEDs	Lens	Housing	Pack
38812	39 Red	Red	Chrome	1 Pc./Card
38814	39 Amber	Clear	Chrome	1 Pc./Card



1938-39 Ford Car

33 LED Tail Light W/ Chrome Flame Flush Mount Bezel

- New LED lens design is the same size and shape as original Ford lens
- Super bright LED with high quality injection molded polycarbonate lens
- Dual function with tail light & bright stop/turn signal
- Epoxy coated, fully sealed electronics, 1157 plug
- Recommend to upgrade under dash flasher to item # 90652 or 90649 LED

Item Number	LEDs	Lens	Package	Pack
FTL383909	33 Red	Red	Carded	1 Pc./Card



1938-39 Ford Car

19 LED Sequential Tail Light w/Chrome Flame Bezel

- Chrome plated flush mount flame light bezel
- Selector switch to control sequential function off, direction left, or direction right
- Also features brake attention option with sequence-once function
- Epoxy coated, fully sealed electronics, 1157 plug
- Recommend to upgrade under dash flasher to item # 90652 or 90649 LED

Item Number	LEDs	Lens	Package	Pack
110798	19 Red	Red	Carded	1 Pc./Card

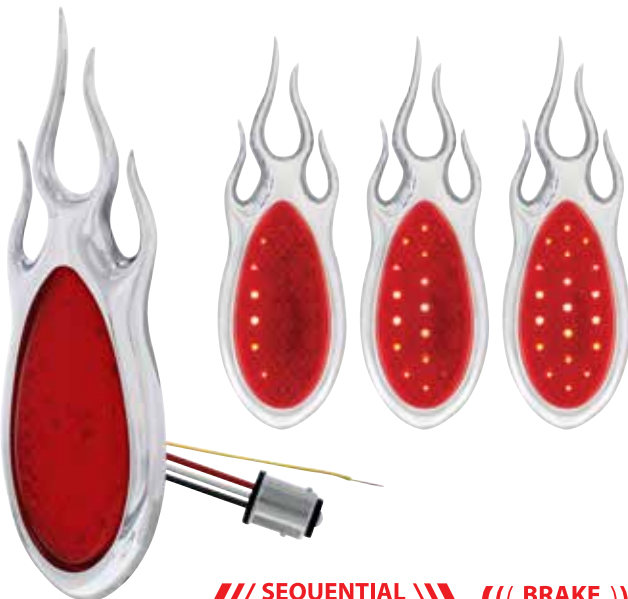

1938-39 Ford Car

33 LED Tail Light w/ Chrome Flame

- New lens design is the same size and shape as original Ford lens
- Super bright LED with high quality polycarbonate lens
- Dual function with tail light & bright stop/turn signal
- Epoxy coated, fully sealed electronics, 1157 plug
- Recommend to upgrade under dash flasher to item # 90652 or 90649 LED

Item Number	LEDs	Lens	Package	Pack
FTL383910	33 Red	Red	Carded	1 Pc./Card



SEQUENTIAL F.L.A.S.H. **BRAKE ATTENTION**

LED LIGHTS
1930s-40s FORD

1938-48 Ford Car

28 Super Bright LED Retrofit Tail Light Insert

- 28 super bright LED retrofit for 1938-48 Ford Tail light with glass lens
- Epoxy coated, fully sealed electronics, 1157 plug
- Energy efficient solid-state circuit board for 12V DC systems

Item Number	LEDs	Lens	Package	Pack
A1060-5	28	Clear	Carded	1 Pc./Card



1940 Ford Car & 1940-41 Ford Truck

21 LED Front Turn Signal

- Super bright LED turn signal with high quality injection molded polycarbonate lens
- 3 mounting clips included with package
- Epoxy coated, fully sealed electronics
- Energy efficient solid-state circuit board for 12V DC systems

Item Number	LEDs	Lens	Housing	Pack
FPL4001LED	12 Amber	Clear	Chrome	1 Pc./Card
FPL4002LED	12 Amber 9 White	Clear	Chrome	1 Pc./Card



1940 Ford Car

24 LED Tail Light w/ Black Flush Mount Bezel

- 24 super bright LED tail light lens with polycarbonate lens
- New lens design is exactly same size & shape as original lens
- Fits all 1940 Ford standard & deluxe passenger cars
- Mounts on fender with 3 small studs, requires drilling 2 small holes behind the light
- Dual function with tail light & bright stop/turn signal
- Includes chrome bezel, rubber pad and mounting studs
- Recommend to upgrade under dash flasher to item # 90652 or 90649 LED

Item Number	LEDs	Lens	Package	Pack
FTL4014LED	24 Red	Red	Carded	1 Pc./Card



1940 Ford Car

24 LED Tail Light w/ Chrome Flush Mount Bezel

- 24 super bright LED tail light lens with polycarbonate lens
- New lens design is exactly same size & shape as original lens
- Fits all 1940 Ford standard & deluxe passenger cars
- Mounts on fender with 3 small studs, requires drilling 2 small holes behind the light
- Dual function with tail light & bright stop/turn signal
- Includes chrome bezel, rubber pad and mounting studs
- Recommend to upgrade under dash flasher to item # 90652 or 90649 LED

Item Number	LEDs	Lens	Package	Pack
FTL4005LED	24 Red	Red	Carded	1 Pc./Card



1940 Ford Car

24 LED Tail Light Lens

- 24 super bright LED tail light lens with polycarbonate lens
- New lens design is exactly same size & shape as original lens
- Dual function with tail light & bright stop/turn signal
- Epoxy coated, fully sealed electronics, 1157 plug
- Recommend to upgrade under dash flasher to item # 90652 or 90649 LED

Item Number	LEDs	Lens	Package	Pack
FTL4004LED	24 Red	Red	Carded	1 Pc./Card



1940 Ford Car

Chrome Tail Light Bezel and Mounting Pad

- 1940 Ford chrome flush mount bezel for FTL4004LED
- 1940 flush mount rubber pad for original curved or flat fender

Item Number	LEDs	Pack
FTL4004RB	Chrome Tail light Bezel	1 Pc.
FTL4004-2	Curved Fender Flush Mount Rubber Pad	1 Pc.



LED LIGHTS
1940s-50s FORD

1940 Ford Passenger Car

20 LED Deluxe Tail Light

- 20 super bright LED tail light lens with polycarbonate lens
- Epoxy coated, fully sealed electronics
- Easy wiring with hard wired 1157 double contact plug
- Energy efficient solid-state circuit board for 12V DC systems
- Recommend to upgrade under dash flasher to item # 90652 or 90649 LED
- Chrome bezel also available separately item # FT4003

Item Number	LEDs	Lens	Package	Pack
FTL4006LED	20 Red	Red	Carded	1 Pc./Card



1940 Ford Passenger Car

20 LED Deluxe Tail Light

- 20 super bright LED tail light lens with polycarbonate lens
- Complete with stainless steel rim and black housing
- Epoxy coated, fully sealed electronics
- Easy wiring with hard wired 1157 double contact plug
- Energy efficient solid-state circuit board for 12V DC systems
- Recommend to upgrade under dash flasher to item # 90652 or 90649 LED

Item Number	LEDs	Lens	Package	Pack
FTL4011LED	20 Red	Red	Carded	1 Pc./Card



1940 Ford Passenger Car
 1948-56 Ford Panel Truck
 1946-48 Sportsman

21 LED Deluxe Tail Light

- 21 super bright LED tail light lens with polycarbonate lens
- Epoxy coated, fully sealed electronics
- Easy wiring with hard wired 1157 double contact plug
- Energy efficient solid-state circuit board for 12V DC systems
- Recommend to upgrade under dash flasher to item # 90652 or 90649 LED

Item Number	LEDs	Lens	Package	Pack
FTL4101LED	21 Red	Red	Carded	1 Pc./Card



1941 Ford Car

21 LED Tail Light w/ Chrome Bezel and Mounting Pad

- 21 super bright LED tail light lens with polycarbonate lens
- Mounting studs are approximately 4-3/4" apart
- Epoxy coated, fully sealed electronics
- Easy wiring with hard wired 1157 double contact plug
- Energy efficient solid-state circuit board for 12V DC systems
- Recommend to upgrade under dash flasher to item # 90652 or 90649 LED
- Chrome bezel and mounting pad sold separately, item # FTL4101R & FTL4101-1

Item Number	LEDs	Lens	Package	Pack
FTL414103	21 Red	Red	Carded	1 Pc./Card



1941 Ford Car

21 Super Bright LED Retrofit Tail Light Insert

- 21 super bright LEDs with amber polycarbonate lens
- Beautiful die-cast chrome bezel
- Mounting studs are approximately 4-3/4" apart
- Epoxy coated, fully sealed electronics
- Energy efficient solid-state circuit board for 12V DC systems
- Chrome bezel and mounting pad sold separately, item # FTL4101R & FTL4101-1

Item Number	LEDs	Lens	Package	Pack
FPL4111A	21 Amber	Amber	Bulk	1 Pc./Card



5 3/16"



4 3/4"

1941 Ford

21 Super Bright LED Retrofit Tail Light Insert

- 21 super bright LEDs with amber polycarbonate lens
- Epoxy coated, fully sealed electronics
- Energy efficient solid-state circuit board for 12V DC systems

Item Number	LEDs	Lens	Package	Pack
FPL4101A	21 Amber	Amber	Bulk	1 Pc./Card

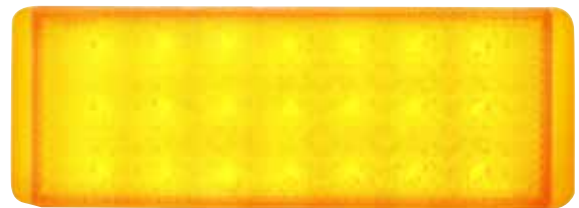
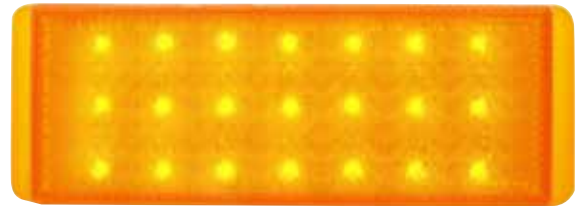

1942-48 Ford

40 Super Bright LED Tail Light

- 40 super bright LEDs with polycarbonate lens, stainless steel bezel and black housing
- Epoxy coated, fully sealed electronics, 1157 plug
- Solid state circuit boards are designed for 7.7 - 14.0 VDC

Item Number	LEDs	Lens	Package	Pack
F42802	40 Red	Red	Boxed	1 Pc./Box



1942-48 Ford

40 Super Bright LED Tail Light

- 40 super bright LEDs with polycarbonate lens
- Epoxy coated, fully sealed electronics, 1157 plug
- Solid state circuit boards are designed for 7.7 - 14.0 VDC

Item Number	LEDs	Lens	Package	Pack
FTL4248LED	40 Red	Red	Carded	1 Pc./Card
FTL4248C	40 Red	Clear	Carded	1 Pc./Card



LED LIGHTS
1940s-50s FORD

1942-48 Ford Passenger Car

40 LED Stainless Steel Flush Mount Tail Light Assembly

- 40 super bright LED tail light lens with polycarbonate lens, stainless steel rim and flush mount backing plate
- Epoxy coated, fully sealed electronics
- Easy wiring with 1157 double contact plug
- Recommend to upgrade under dash flasher to item # 90652 or 90649 LED

Item Number	LEDs	Lens	Package	Pack
F42803	40 Red	Red	Bulk	1 Pc.
F42803C	40 Red	Clear	Bulk	1 Pc.



1942-48 Ford Car

40 LED Chrome Die-cast Flush Mount Tail Light Assembly

- 40 super bright LED tail light lens with polycarbonate lens, chrome die-cast rim and flush mount bezel
- Epoxy coated, fully sealed electronics
- Easy wiring with 1157 double contact plug
- Recommend to upgrade under dash flasher to item # 90652 or 90649 LED

Item Number	LEDs	Lens	Package	Pack
FTL424803	40 Red	Red	Bulk	1 Pc.
FTL424804	40 Red	Clear	Bulk	1 Pc.



1942-48 Ford Car

Stainless Steel Flush Mount Tail light Bezel

- Die stamped highly polished stainless steel

Item Number	Description	Package	Pack
F42805	Stainless Flush Mount Bezel	Bulk	1 Pc.



1942-48 Ford Car

Chrome Flush Mount Tail light Bezel

- Chrome flush mount bezel with 3 stud mount

Item Number	Description	Package	Pack
FTL4248R	Chrome Flush Mount Bezel	Bulk	1 Pc.



1942-48 Ford Car

Stainless Steel Flush Mount Tail light Bezel

- High quality durable rubber material

Item Number	Description	Package	Pack
FTL4248-1	Mounting Pad	Bulk	1 Pc.



1947-48 Ford Car & 1942-47 Ford Truck

21 LED Parking Light Lens

- 21 super bright LED tail light with polycarbonate lens
- Dual function with parking light and bright turn signal
- Easy wiring with 1157 double contact plug, 12 volt only
- Lens fits all original and reproduction Ford parking light assemblies
- Recommend to upgrade under dash flasher to item # 90652 or 90649 LED flasher
- Gasket available separately item # F474804

Item Number	LEDs	Lens	Package	Pack
FTL4748A	21 Amber	Amber	Carded	1 Pc./Carded
FTL4748C	21 Amber	Clear	Carded	1 Pc./Carded



1949-50 Ford Car

33 LED Tail Light Assembly w/ Chrome Bezel

- 33 super bright LED tail light lens with polycarbonate lens
- Epoxy coated, fully sealed electronics, 1157 plug
- Chrome zinc die cast rim, complete assembly includes housing, mounting hardware, socket, and wires
- Recommend to upgrade under dash flasher to item # 90652 or 90649 LED flasher

Item Number	LEDs	Lens	Package	Pack
FTL4950LED-AS	33 Red	Red	Carded	1 Pc./Carded



1949-50 Ford Car

33 LED Tail Light

- 33 super bright LED tail light lens with polycarbonate lens
- Epoxy coated, fully sealed electronics, 1157 plug
- Energy efficient solid-state circuit board for 12V DC systems
- Recommend to upgrade under dash flasher to item # 90652 or 90649 LED flasher

Item Number	LEDs	Lens	Package	Pack
FTL4950LED	33 Red	Red	Carded	1 Pc./Carded



1949-50 Ford Passenger Car

Chrome Die Cast Tail light Bezel

- Chrome die cast bezel for 1949-50 Ford passenger car tail light

Item Number	Description	Package	Pack
F49503	Chrome Tail light Bezel	Bulk	1 Pc.



1949-50 Ford Passenger Car

Tail light Gasket

- Made of high quality sponge rubber
- Die cut to the exact shape and size to provide a tight seal

Item Number	Description	Package	Pack
F49501	Tail light Gasket	Bulk	1 Pc.



1949-50 Ford Passenger Car

Tail light Mounting Pad

- Made of high quality sponge rubber
- Die cut to the exact shape and size to provide a tight seal

Item Number	Description	Package	Pack
F49504	Tail light Mounting Pad	Bulk	1 Pc.



LED LIGHTS
1940s-50s FORD

1947-48 Ford Car & 1942-47 Ford Truck

26 LED Parking Light Assembly

- 26 super bright LED parking light with polycarbonate lens
- Dual function tail light and bright turn signal
- Complete assembly with LED lens and polished stainless steel rim
- Easy wiring with 1157 double contact plug, 12 volt only
- Includes stamped steel housing with socket, bulb, and pigtail
- Recommend to upgrade under dash flasher to item # 90652 or 90649 LED flasher. Fits L/H or R/H side

Item Number	LEDs	Lens	Package	Pack
110139	26 Amber	Amber	Carded	1 Pc./Carded
110138	26 Amber	Clear	Carded	1 Pc./Carded



1953-56 Ford Truck

38 LED Sequential Tail Light W/ Chrome Housing

- 38 SMD LED sequential tail light with polycarbonate lens
- Additional white LED with clear lens for license plate light
- Features sequential function with selector switch to control sequential function off, direction left, or direction right
- Features sequence-once brake attention function
- Fully assembled chrome plated die stamped metal housing
- Upgrade under dash flasher to item # 90652 or 90651

Item Number	LEDs	Lens	Application	Pack
110761	38 Red	Red	Driver	1 Pc./Carded
110762	38 Red	Red	Passenger	1 Pc./Carded



(((SEQUENTIAL)))
 F · L · A · S · H

(((BRAKE ATTENTION)))

1951 Ford Passenger Car

44 LED Tail Light Insert Board

- Super bright LED circuit board installs behind existing lens
- Dual function with tail light & bright stop/turn signal
- Easy electrical connection with 1157 plug, no modification to vehicle
- Recommend to upgrade under dash flasher to item # 90652 or 90649 LED flasher

Item Number	LEDs	Lens	Package	Pack
110128	44 Red	Red	Carded	1 Pc./Carded



1953-56 Ford Truck

38 LED Tail Light W/ Black Housing

- 38 SMD LED sequential tail light with polycarbonate lens
- Additional white LED with clear lens for license plate light
- Fully assembled glossy black die stamped metal housing with studs
- Electronics completely sealed in epoxy to resist corrosion and moisture
- Solid-state circuit board engineered for 12V DC systems
- Recommend to upgrade under dash flasher to item # 90652 or 90651 LED flasher

Item Number	LEDs	Lens	Application	Pack
110759	38 Red	Red	Driver	1 Pc./Carded
110760	38 Red	Red	Passenger	1 Pc./Carded



1953-56 Ford Truck

38 LED Sequential Tail Light w/ Black Housing

- 38 super bright SMD LED sequential tail light with high quality polycarbonate lens
- Additional white LED with clear lens for license plate light
- Features sequential function with selector switch to control sequential function off, direction left, or direction right
- Features sequence-once brake attention function
- Fully assembled with beautiful glossy black plated die stamped metal housing with mounting studs
- Recommend to upgrade under dash flasher to item # 90652 (2-terminal) or 90651 (3-terminal)

Item Number	LEDs	Lens	Application	Pack
110763	38 Red	Red	Driver	1 Pc./Carded
110764	38 Red	Red	Passenger	1 Pc./Carded



(((SEQUENTIAL)))
F · L · A · S · H (((BRAKE)))
ATTENTION



(((SEQUENTIAL)))
F · L · A · S · H (((BRAKE)))
ATTENTION

1953-56 Ford Truck

38 LED Tail Light Lens

- 38 super bright LED tail light with high quality polycarbonate lens
- Additional white LED with clear lens for license plate light
- Easy electrical connection with 1157 plug, no modification to vehicle
- Electronics completely sealed in epoxy to resist corrosion and moisture
- Energy efficient solid-state circuit board for 12V DC systems
- Recommend to upgrade under dash flasher to item # 90652 (2-terminal) or 90651 (3-terminal)

Item Number	LEDs	Lens	Application	Pack
110142	38 Red	Red	Driver	1 Pc./Carded
110143	38 Red	Red	Passenger	1 Pc./Carded



1953-56 Ford Truck

38 LED Sequential Tail Light

- 38 super bright LED sequential tail light with high quality polycarbonate lens
- Additional white LED with clear lens for license plate light
- Features sequential function with selector switch to control sequential function off, direction left, or direction right
- Features sequence-once brake attention function
- 1157 double connector with offset pins, plugs into existing socket
- Recommend to upgrade under dash flasher to item # 90652 or 90651 LED flasher

Item Number	LEDs	Lens	Application	Pack
110144	38 Red	Red	Driver	1 Pc./Carded
110145	38 Red	Red	Passenger	1 Pc./Carded

LED LIGHTS
FORD MUSTANG



1964 1/2-66 Ford Mustang

68 LED Sequential Tail Light Lens

- 68 super bright LEDs with polycarbonate lens
- Sequential operation with selector switch to select sequential left, sequential right, or sequential function off
- Epoxy coated, fully sealed electronics
- Easy wiring with 1157 double contact plug
- Energy efficient solid-state circuit board for 12VDC systems
- Recommend to upgrade under dash flasher to item # 90652 or 90649 LED
- Lifetime warranty

Item Number	LEDs	Lens	Package	Pack
110105	68 Red	Red	Carded	1 Pc./Card



(((SEQUENTIAL)))
F · L · A · S · H

(((BRAKE ATTENTION)))

1964 1/2-66 Ford Mustang

68 LED Tail Light Lens

- 68 super bright LEDs with high quality polycarbonate lens
- Epoxy coated, fully sealed electronics, 1157 double contact plug
- Energy efficient solid-state circuit board for 12V DC systems
- Recommend to upgrade under dash flasher to item # 90652 or 90649 LED
- Chrome bezel sold separately item # F6405

Item Number	LEDs	Lens	Package	Pack
FTL6401LED	68 Red	Red	Carded	1 Pc./Card



1964 1/2-66 Ford Mustang

68 LED Tail Light Lens With Chrome Housing & Rim

- 68 super bright LEDs with high quality polycarbonate lens
- Includes original style wiring connector and mounting hardware
- Epoxy coated, fully sealed electronics
- Easy wiring with 1157 double contact plug
- Energy efficient solid-state circuit board for 12V DC systems
- Recommend to upgrade under dash flasher to item # 90652 or 90649 LED

Item Number	LEDs	Lens	Package	Pack
FTL6411LED	68 Red	Red	Carded	1 Pc./Card



1964 1/2-66 Ford Mustang

48 LED Parking Light

- 48 super bright amber LEDs with amber polycarbonate lens
- Not for use on early Mustang with single dash indicator
- Epoxy coated, fully sealed electronics
- Easy wiring with 1157 double contact plug
- Energy efficient solid-state circuit board for 12V DC systems

Item Number	LEDs	Lens	Package	Pack
FPL6401LED	48 Amber	Amber	Carded	1 Pc./Card



1967-68 Ford Mustang

84 LED Sequential Tail Light Lens

- 84 super bright LEDs with polycarbonate lens
- Sequential operation with selector switch to select sequential left, sequential right, or sequential function off
- Also features brake attention option with sequence-once function
- Epoxy coated fully sealed electronics, 1157 double plug
- Energy efficient solid-state circuit board for 12V DC systems
- Recommend to upgrade under dash flasher to item # 90652 or 90649 LED
- Lifetime warranty

Item Number	LEDs	Lens	Package	Pack
110106	84 Red	Red	Carded	1 Pc./Card



««« SEQUENTIAL »»» (((BRAKE ATTENTION)))

1969 Ford Mustang

108 LED Sequential Tail Light Lens

- 108 super bright LEDs with high quality polycarbonate lens
- Sequential operation with selector switch to select sequential left, sequential right, or sequential function off
- Includes polished stainless steel trim rings attached
- Epoxy coated fully sealed electronics, 1157 double contact plug
- Energy efficient solid-state circuit board for 12VDC systems
- Recommend to upgrade under dash flasher to item # 90652 or 90649 LED
- Lifetime warranty

Item Number	LEDs	Lens	Package	Pack
110107	108 Red	Red	Carded	1 Pc./Card



««« SEQUENTIAL »»» (((BRAKE ATTENTION)))

1967-68 Ford Mustang

84 LED Tail Light Lens

- 84 super bright LEDs with high quality polycarbonate lens
- Epoxy coated fully sealed electronics, 1157 double contact plug
- Energy efficient solid-state circuit board for 12V DC systems
- Recommend to upgrade under dash flasher to item # 90652 or 90649

Item Number	LEDs	Lens	Package	Pack
FTL6701LED	84 Red	Red	Carded	1 Pc./Card



1969 Ford Mustang

108 LED Tail Light

- 108 super bright LEDs with high quality polycarbonate lens
- Includes polished stainless steel rims
- Epoxy coated fully sealed electronics, 1157 double contact plug
- Energy efficient solid-state circuit board for 12V DC systems
- Includes polished stainless steel trim ring attached
- Recommend to upgrade under dash flasher to item # 90652 or 90649

Item Number	LEDs	Lens	Package	Pack
FTL6901LED	108 Red	Red	Carded	1 Pc./Card





1961 Ford Thunderbird

41 LED Tail Light

- 41 super bright red LEDs with high quality polycarbonate lens
- Epoxy coated, fully sealed electronics, 1157 plug
- Energy efficient solid-state circuit board for 12V DC systems
- Recommend to upgrade under dash flasher to item # 90652 or 90649 LED flasher
- Rubber mounting pad sold separately, item # S10051-1

Item Number	LEDs	Lens	Package	Pack
FTL6106LED	41 Red	Red	Carded	1 Pc./Card

1964 Ford Thunderbird

68 LED Tail Light

- 68 super bright red LEDs with high quality polycarbonate lens
- Epoxy coated, fully sealed electronics, 1157 plug
- Easy wiring with 1157 double contact plug
- Energy efficient solid-state circuit board for 12V DC systems
- Recommend to upgrade under dash flasher to item # 90652 or 90649 LED flasher

Item Number	LEDs	Lens	Package	Pack
FTL6406LED	68 Red	Red	Carded	1 Pc./Card



1964 Ford Thunderbird

Tail Light Lens with Chrome Emblem

- High quality reproduction of the original lens
- Beautiful chrome plate emblem

Item Number	Description	Package	Pack
F6411	Tail light Lens with Emblem	Bulk	1 Pc.



1964 Ford Thunderbird

Tail Light Lens

- High quality reproduction of the original lens

Item Number	Description	Package	Pack
F6411-1	Tail light Lens	Bulk	1 Pc.



1964 Ford Thunderbird

Chrome Thunderbird Tail Light Emblem

- Beautiful chrome plated finish with triple chrome plating process
- Perfect replacement for missing or damaged tail light emblem

Item Number	Description	Package	Pack
F6412	Tail light Emblem	Bulk	1 Pc.



LED LIGHTS
FORD BRONCO



1967-72 Ford Truck & 1966-77 Ford Bronco

27 LED Tail Light Insert Board

- Retrofit circuit board with super bright LEDs
- Installs behind original tail light lens
- Dual function with driving, and bright stop/turn signal
- Easy electrical connection w/ 1157 plug no modification to vehicle
- Recommend to upgrade under dash flasher to item # 90652 or 90649 LED

Item Number	LEDs	Application	Package	Pack
FTL6772LED-L	27 Red	Driver	Bulk	1 Pc.
FTL6772LED-R	27 Red	Passenger	Bulk	1 Pc.
FTL6772LED-PR	27 Red	Driver/passenger	Carded	1 Set.

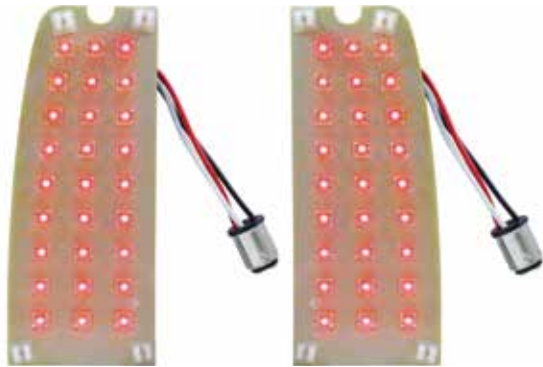

1967-72 Ford Truck & 1967-77 Bronco

27 LED Sequential Tail Light Retrofit Board

- Super bright LED circuit board installs behind existing lens
- Dual function with tail light & bright stop/turn signal
- Features sequential operation with selector switch to select sequential function on/off
- Also features brake attention option with sequence-once function
- Easy wiring with hard wired 1157 double contact plug
- Recommend to upgrade under dash flasher to item # 90652 or 90649 LED flasher

Item Number	LEDs	Lens	Application	Pack
110497	27	-	Tail Light	1 Pc./Card

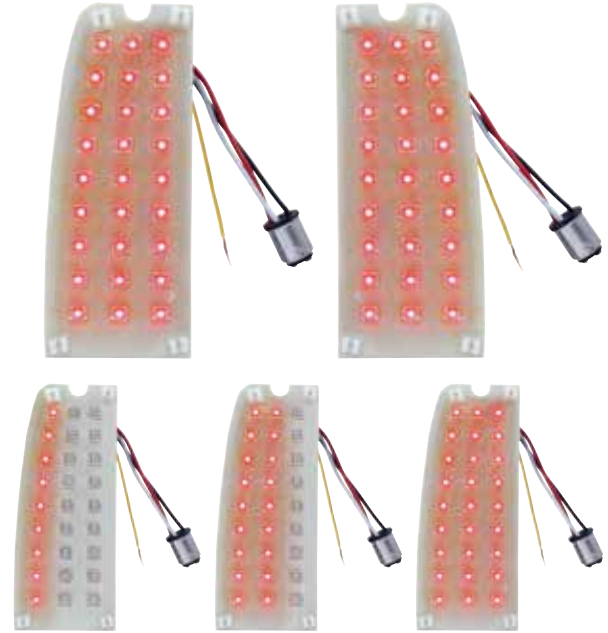

<<< SEQUENTIAL >>>
(((BRAKE)))
F · L · A · S · H
ATTENTION

1966-77 Ford Bronco

Anodized Billet Aluminum Tail Light Bezel

- CNC milled out of a single solid aluminum block
- Beautifully CNC milled from billet aluminum
- Durable anodized finish to resist corrosion while keeping the machined finished look
- Stainless steel extended length socket head screws included for use with original tail light lens mounting holes
- Includes foam gaskets to prevent scratches to the tail light panel
- Sold as a set

Item Number	Description	Package	Pack
110583	Clear Anodized Aluminum	Box	1 Pc.
110584	Black Anodized Aluminum	Box	1 Pc.



1967-72 Ford Truck & 1967-77 Bronco

Tail Light Lens Gasket (Pair)

- Fits between tail light housing and lens
- Made of quality white foam rubber as original
- Die cut to the exactly as original to provide a nice tight seal

Item Number	Description	Package	Pack
110497	Tail Light Lens Gasket	Card	1 Pair

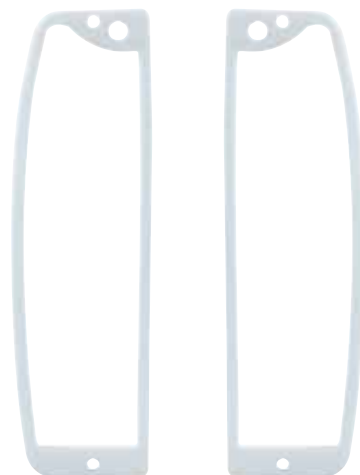

LED LIGHTS
FORD BRONCO

1969-77 Ford Bronco

Anodized Billet Aluminum Turn Signal Bezel (Pair)

- Beautifully CNC milled from billet aluminum
- Durable clear anodized finish to resist corrosion while keeping the machined finished look
- Mounts between the front turn signal bucket and the grille
- Includes mounting gaskets, sold in pairs

Item Number	Description	Package	Pack
110837	Clear Anodized Aluminum	Box	1 Pair
110838	Black Anodized Aluminum	Box	1 Pair



1969-77 Ford Bronco

35 LED Front Parking/Signal Light

- 35 LED parking/signal light for 1969-77 Ford Bronco
- LED dual function, parking light and turn signal
- Epoxy coated, fully sealed electronics, 1157 plug
- Fits left hand or right hand
- Also fits 1959-64 Ford F100, F250, F350, and 1968-74 Econoline

Item Number	LEDs	Lens	Package	Pack
110382	35 Amber	Amber	Carded	1 Pc./Card

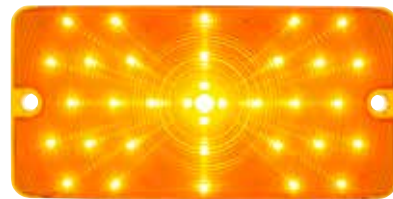

1970-77 Ford Bronco

Anodized Billet Aluminum Low Side Marker Bezel

- Anodized billet aluminum side marker bezel with raised side protection
- Beautifully CNC milled from billet aluminum
- Durable clear anodized finish to resist corrosion while keeping the machined finished look
- Includes two stainless steel screws and mounting gasket
- Also fits 1970-74 Econoline, and rear 1970-72 F100, F150, & F250
- Sold each

Item Number	Description	Package	Pack
110774	Clear Anodized Aluminum	Box	1 Pc.
110775	Black Anodized Aluminum	Box	1 Pc.



1969-77 Ford Bronco

Anodized Billet Aluminum Side Marker Bezel

- Anodized billet aluminum side marker bezel with raised side protection
- Beautifully CNC milled from billet aluminum
- Durable clear anodized finish to resist corrosion while keeping the machined finished look
- Includes two stainless steel screws and mounting gasket
- Also fits 1970-74 Econoline, and rear 1970-72 F100, F150, & F250
- Sold each

Item Number	Description	Package	Pack
110772	Clear Anodized Aluminum	Box	1 Pc.
110773	Black Anodized Aluminum	Box	1 Pc.



1970-77 Ford Bronco

8 LED Side Marker Light

- 8 LED dual function, parking light and turn signal
- Super bright amber LED with amber acrylic lens
- Epoxy coated, fully sealed electronics
- Fits left hand and right hand

Item Number	LEDs	LENS	Application	Package	Pack
110804	8 Amber	Amber	Front	Carded	1 Pc./Card
110805	8 Red	Red	Rear	Carded	1 Pc./Card



1953-56 Ford Truck

12 LED License Plate Light W/ Clear Lens

- 12 super bright white LEDs with high quality polycarbonate lens
- Epoxy coated, fully sealed electronics
- Easy electrical connection w/ 1157 plug, no modification to vehicle
- Energy efficient solid-state circuit board for 12V DC systems

Item Number	LEDs	Lens	Package	Pack
FTL5356LLB	12 White	Clear	Carded	1 Pc./Card



LED LIGHTS
1950s PONTIAC

1963-67 Shelby Cobra

36 LED Tail Light

- Exact replacement of original Shelby Cobra tail light
- Includes mounting pad and hardware
- Energy efficient solid-state circuit board for 12V DC systems
- Epoxy coated, fully sealed electronics
- Recommend to upgrade under dash flasher to item # 90652 or 90649 LED flasher

Item Number	LEDs	Lens	Application	Pack
STL1012LED	36 Red	Red	Tail light	1 Pc./Card



1950s Pontiac Style

41 LED Round Tail Light

- 41 super bright amber LEDs with amber polycarbonate lens
- 3 5/16" diameter tail light
- Epoxy coated, fully sealed electronics
- Fits United Pacific rim item # S1005
- Recommend to upgrade under dash flasher to item # 90652 or 90649 LED

Item Number	LEDs	Lens	Package	Pack
STL1001LED	41 Red	Red	Carded	1 Pc./Card



1950s Ford Pontiac

Chrome 1950s Pontiac Style Tail Light Bezel

- 4 5/16 round chrome zinc die-cast bezel with two mounting studs
- Fits Pontiac style LED light item # STL1001LED/STL1002

Item Number	Description	Package	Pack
S1005	Pontiac Style Tail Light Bezel	Bulk	1 Pc.

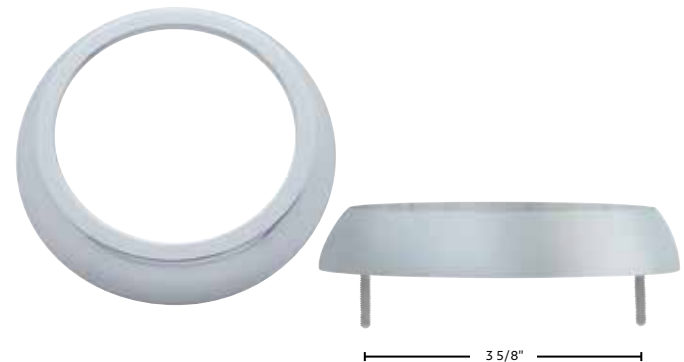

1950s Pontiac Style

41 LED Pontiac Style Tail Light W/ Chrome Bezel

- 41 super bright red LEDs with high quality polycarbonate lens
- 3 5/16" dia. with 4 5/16" dia. chrome bezel
- Epoxy coated, fully sealed electronics
- Energy efficient solid-state circuit board for 12V DC systems
- Rubber pad sold separately item # S10051-1
- Recommend to upgrade under dash flasher to item # 90652 or 90649 LED flasher

Item Number	LEDs	Lens	Package	Pack
STL1006LED	41 Red	Red	Carded	1 Pc./Card



1950s Pontiac Style

41 LED Spider Web Style Tail Light

- 41 super bright LEDs with high quality polycarbonate lens
- Chrome spider lens overlay styled after 1936 Chrysler Airflow tail lamp lens, mounts flat to surface with 2 small studs
- Dual function with tail light & bright turn signal
- Epoxy coated, fully sealed electronics
- Rubber mounting pad sold separately, item # S1005-1

Item Number	LEDs	Lens	Application	Pack
STL1004LED	41 Red	Red	LH & RH	1 Pc./Box



1937-42 Willys

22 LED Tail Light

- Fits in place of the original glass lens
- Epoxy coated, fully sealed electronics
- Energy efficient solid-state circuit board for 12VDC systems
- Recommend to upgrade under dash flasher to item # 90652 or 90649 LED

Item Number	LEDs	Lens	Package	Pack
STL1010LED	22 Red	Red	Carded	1 Pc./Card



1937-42 Willys

22 LED Tail Light Assembly

- 22 super bright red LEDs with polished stainless steel bezel
- Mounts with two studs, long enough to use with fiberglass bodies
- Includes flat mounting pad and wedge mounting pad
- Epoxy coated, fully sealed electronics
- Energy efficient solid-state circuit board for 12VDC systems
- Recommend to upgrade under dash flasher to item # 90652 or 90649 LED

Item Number	LEDs	Lens	Package	Pack
STL1010LED-AS	22 Red	Red	Bulk	1 Pc.



1968 Dodge Charger

25 LED Tail Light

- 25 super bright LEDs with polycarbonate lens
- Epoxy coated, fully sealed electronics
- Easy wiring with 1157 double contact plug
- Solid state circuit boards are designed for 7.7 - 14.0 VDC

Item Number	LEDs	Lens	Package	Pack
DTL6801LED	25 Red	Red	Carded	1 Pc./Card

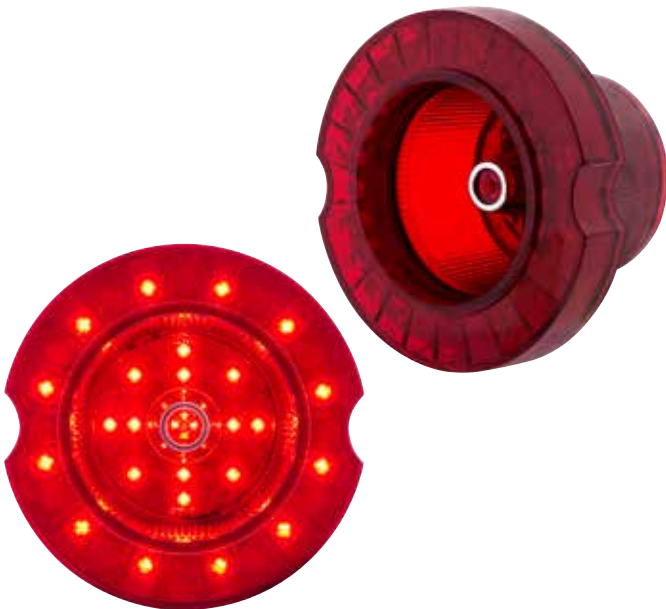

1968-70 VW Beetle

46 LED Tail Light

- 46 super bright red LEDs for tail light/stop light/turn signal
- 20 super bright white LEDs for backup light, polycarbonate lens
- Plug-n-play, fits in place of original lens without modification
- Easy electrical hook-up with mail push-on terminals
- Includes stainless steel trim and mounting screws

Item Number	LEDs	Lens	Application	Pack
VTL6870LED	46 Red 20 White	Red/ White	Tail Back-Up	1 Pc./Card



HONDA & PEDESTAL LIGHTS

Honda

13 LED 2 1/8" Arm Light Kit w/ Flame Bezel

- 13 super bright LED Honda light with 2 1/8" arm and flame bezel
- Beautiful high quality chrome plated housing with triple chrome plating process
- 2 wires (hard wired)

Item Number	LEDs	Lens	Package	Pack
38496	13 Amber	Amber	Carded	1 Pc./Card
38497	13 Red	Red	Carded	1 Pc./Card
38498	13 White	Clear	Carded	1 Pc./Card



Honda

13 LED 1 1/8" Arm Light Kit w/ Flame Bezel

- 13 super bright LED Honda light with 1 1/8" arm and flame bezel
- Beautiful high quality chrome plated housing with triple chrome plating process
- 2 wires (hard wired)

Item Number	LEDs	Lens	Package	Pack
38492	13 Amber	Amber	Carded	1 Pc./Card
38493	13 Red	Red	Carded	1 Pc./Card
38494	13 Amber	Clear	Carded	1 Pc./Card



Honda

13 LED 2 1/8" Arm Watermelon Light Kit

- 13 super bright LED watermelon Honda light with 2 1/8" arm
- Beautiful high quality chrome plated housing with triple chrome plating process
- 2 wires (hard wired)

Item Number	LEDs	Lens	Package	Pack
38824	13 Amber	Amber	Carded	1 Pc./Card
38825	13 Red	Red	Carded	1 Pc./Card



Honda

13 LED 1 1/8" Arm Watermelon Light Kit

- 13 super bright LED watermelon Honda light with 1 1/8" arm
- Beautiful high quality chrome plated housing with triple chrome plating process
- 2 wires (hard wired)

Item Number	LEDs	Lens	Package	Pack
38820	13 Amber	Amber	Carded	1 Pc./Card



Honda

11 LED 2 1/8" Arm Watermelon Light Kit w/ Visor

- 11 super bright LED watermelon Honda light with 2 1/8" arm and visor
- Beautiful high quality chrome plated housing with triple chrome plating process
- 2 wires (hard wired)

Item Number	LEDs	Lens	Package	Pack
38595	11 Amber	Amber	Carded	1 Pc./Card
38597	11 Amber	Clear	Carded	1 Pc./Card
38596	11 Red	Red	Carded	1 Pc./Card
38598	11 Red	Clear	Carded	1 Pc./Card

Honda

11 LED 1 1/8" Arm Watermelon Light Kit w/ Visor

- 11 super bright LED watermelon Honda light with 1 1/8" arm and visor
- Beautiful high quality chrome plated housing with triple chrome plating process
- 2 wires (hard wired)

Item Number	LEDs	Lens	Package	Pack
38444	11 Amber	Amber	Carded	1 Pc./Card
38446	11 Amber	Clear	Carded	1 Pc./Card
38445	11 Red	Red	Carded	1 Pc./Card
38447	11 Red	Clear	Carded	1 Pc./Card



HONDA & PEDESTAL LIGHTS*Honda***11 LED 2 1/8" Arm Watermelon Light Kit**

- 11 super bright LED watermelon Honda light with 2 1/8" arm
- Beautiful high quality chrome plated housing with triple chrome plating process
- 2 wires (hard wired)

Item Number	LEDs	Lens	Package	Pack
38440	11 Amber	Amber	Carded	1 Pc./Card
38442	11 Amber	Clear	Carded	1 Pc./Card
38441	11 Red	Red	Carded	1 Pc./Card
38443	11 Red	Clear	Carded	1 Pc./Card

*Honda***11 LED 1 1/8" Arm Watermelon Light Kit**

- 11 super bright LED watermelon Honda light with 1 1/8" arm
- Beautiful high quality chrome plated housing with triple chrome plating process
- 2 wires (hard wired)

Item Number	LEDs	Lens	Package	Pack
38436	11 Amber	Amber	Carded	1 Pc./Card
38438	11 Amber	Clear	Carded	1 Pc./Card
38437	11 Red	Red	Carded	1 Pc./Card
38439	11 Red	Clear	Carded	1 Pc./Card



Honda

13 LED 2 1/8" Arm Light Kit

- 13 super bright LED Honda light with 2 1/8" arm
- High quality chrome plated housing with triple chrome plating
- 2 wires (hard wired)

Item Number	LEDs	Lens	Package	Pack
38379	13 Amber	Amber	Carded	1 Pc./Card
38389	13 Amber	Clear	Carded	1 Pc./Card
38380	13 Red	Red	Carded	1 Pc./Card



Honda

13 LED 1 1/8" Arm Light Kit

- 13 super bright LED Honda light with 1 1/8" arm
- High quality chrome plated housing with triple chrome plating
- 2 wires (hard wired)

Item Number	LEDs	Lens	Package	Pack
38375	13 Amber	Amber	Carded	1 Pc./Card
38377	13 Amber	Clear	Carded	1 Pc./Card
38376	13 Red	Red	Carded	1 Pc./Card



Pedestal Light

2 High Power LED "Hyper Mini"

- 1W rebel 3045 LED, 100. Waterproof compact design
- Heavy duty chrome die-cast housing
- Vertical & horizontal mounting application
- Universal application, install anywhere
- Lifetime warranty

Item Number	LEDs	Lens	Package	Pack
36673	2 Amber	Clear	Carded	1 Pc./Card
36675	2 Red	Clear	Carded	1 Pc./Card
36676	2 White	Clear	Carded	1 Pc./Card



ROD AND BULLET LIGHTS

6 LED Medium Rod Lights

- 6 LED medium rectangular rod light with chrome housing
- 3 wires (hard wired), 12 volt

Item Number	LEDs	Lens	Package	Pack
39192	6 Amber	Amber	Carded	1 Pc./Card
39193	6 Red	Red	Carded	1 Pc./Card



6 LED Medium Rod Light

- 6 super bright red LEDs with red polycarbonate lens
- 3 wires (hard wired)

Item Number	LEDs	Lens	Package	Pack
39515B	6 Red	Red	Bulk	1 Pc./Bulk



6 LED Large Rod Lights

- 6 LED large rectangular rod light with chrome housing
- 3 wires (hard wired), 12 volt

Item Number	LEDs	Lens	Package	Pack
39196	6 Amber	Amber	Carded	1 Pc./Card
39197	6 Red	Red	Carded	1 Pc./Card
39199	6 Red	Clear	Carded	1 Pc./Card



4 LED Small Rod Lights

- 4 LED small rectangular rod light with chrome housing
- 3 wires (hard wired), 12 volt

Item Number	LEDs	Lens	Package	Pack
39188	4 Amber	Amber	Carded	1 Pc./Card
39189	4 Red	Red	Carded	1 Pc./Card



4 LED Small Rod Light

- 4 super bright LEDs with polycarbonate lens
- 3 wires (hard wired)

Item Number	LEDs	Lens	Package	Pack
39511B	4 Amber	Amber	Bulk	1 Pc./Bulk
39512B	4 Red	Red	Bulk	1 Pc./Bulk



9 LED Dual Function Mini Bullet Lights

- 9 LED mini bullet light with chrome housing, dual function
- Perfect for custom installation on motorcycles, trucks and hot rods
- Chrome bullet housing available separately: item # 30105B

Item Number	LEDs	Lens	Package	Pack
36859	9 Amber	Amber	Carded	1 Pc./Card
36860	9 Red	Red	Carded	1 Pc./Card



15 LED 3" Single Face Light

- 15 LED single face auxiliary light with chrome housing
- For auxiliary/utility light applications, 2 wires (hard wired)

Item Number	LEDs	Lens	Package	Pack
38853	15 Amber	Amber	Carded	1 Pc./Card
38855	15 Amber	Clear	Carded	1 Pc./Card
38856	15 Red	Clear	Carded	1 Pc./Card



17 LED Watermelon Double Face Light

- Durable heavy duty chrome plated housing with single stud mount
- Beautiful high quality chrome plated housing with triple chrome plating process
- For auxiliary/utility light application, 2 wires (hard wired)
- Universal application, install anywhere, lifetime warranty

Item Number	LEDs	Lens	Package	Pack
32326	17 Amber/Red	Amber/Red	Carded	1 Pc./Card
32329	17 Amber/Red	Clear	Carded	1 Pc./Card
37308	17 Amber	Dark Amber	Carded	1 Pc./Card



3 LED Straight Mount Double Face Light

- 3 LED rectangular double face auxiliary light
- Chrome die-cast t-mount housing only item # 30963b
- 2 wires (hard wired)

Item Number	LEDs	Lens	Package	Pack
38842	3 Amber/Red	3 Amber/Red	Carded	1 Pc./Card
38843	3 Amber/Red	Clear	Carded	1 Pc./Card



3 LED T-Mount Double Face Light

- 3 LED rectangular double face auxiliary light
- Chrome die-cast t-mount housing only item # 30962b
- 2 wires (hard wired)

Item Number	LEDs	Lens	Package	Pack
38840	3 Amber/Red	3 Amber/Red	Carded	1 Pc./Card
38841	3 Amber/Red	Clear	Carded	1 Pc./Card



LED ACCESSORY LIGHTS
MISCELLANEOUS

19 LED 17" Stop, Turn, Tail Light Bar With Bezel

- 19 LED S/T/T light bar with chrome plastic bezel
- Perfect for trailers or below tailgate on pickups
- Approximate size 17 1/8" L x 1 5/8" W x 1 1/8" H
- Mounting holes are approximately 16" apart

Item Number	LEDs	Lens	Package	Pack
36833	19 Red	Red	Carded	1 Pc./Card



17 LED Flush Mount Tail Light W/ Chrome Bezel

- 17 super bright red LED flush mount bezel
- Light is 3-3/4" dia. and 3/4" tall
- Mounting studs are approximately 3-7/16" apart
- Includes installation hardware and mounting pad
- Recommend to upgrade under dash flasher to item # 90652 or 90649 LED flasher

Item Number	LEDs	Lens	Application	Pack
110406	17 Red	Red	Tail light	1 Pc./Card



10 LED Split Function 3rd Brake Light

- 10 bright red LED 3rd brake light with swivel pedestal base, red polycarbonate lens and beautiful chrome plated housing and base
- Adjustable base mount for inside rear window installation
- Mounting base swivels 180 degrees for multiple applications

Item Number	LEDs	Lens	Application	Pack
33010	10 Red	Red	Brake Light	1 Pc./Card



40 LED Stop, Turn & Tail light With Bezel

- 40 Super bright red LED S/T/T light with chrome plastic bezel
- Flush mount
- Chrome plastic bezel available separately: item # 34027B

Item Number	LEDs	Lens	Application	Pack
37961	40 Red	Red	S/T/T Light	1 Pc./Card



15 LED Pick-Up/SUV Cab Light

- Beautiful chrome plated housing
- Polycarbonate lens sonically sealed to housing to prevent moisture intrusion, epoxy coated fully sealed electronics
- 2 wires (1 wire with ring terminal)

Item Number	LEDs	Lens	Package	Pack
38453	15 Amber	Amber	Carded	1 Pc./Card
38454	15 Amber	Clear	Carded	1 Pc./Card



13 LED Pick-Up/SUV Cab Light

- Beautiful chrome plated housing
- Polycarbonate lens sonically sealed to housing to prevent moisture intrusion, epoxy coated fully sealed electronics
- 2 wires (1 wire with ring terminal)

Item Number	LEDs	Lens	Package	Pack
38451	15 Amber	Amber	Carded	1 Pc./Card
38450	15 Amber	Clear	Carded	1 Pc./Card



6 Amber LED Pick-Up/SUV Cab Light

- Polycarbonate lens sonically sealed to housing to prevent moisture intrusion, epoxy coated fully sealed electronics
- Fits various standard pickup trucks
- Includes mounting gasket

Item Number	LEDs	Lens	Package	Pack
36621B	6 Amber	Amber	Carded	1 Pc./Card



12 LED Door/Interior Light

- 12 super bright amber LED door/interior light with amber lens
- Includes chrome plastic bezel

Item Number	LEDs	Lens	Package	Pack
38021	12 Amber	Amber	Carded	1 Pc./Card



LED ACCESSORY LIGHTS
MISCELLANEOUS

4 LED Mini Bullet Marker Lights

- 4 LED die-cast mini bullet marker light
- Universal application, mounts anywhere, perfect for trucks, 12 volt

Item Number	LEDs	Lens	Package	Pack
37151	4 Blue	Clear	Carded	1 Pc./Card
37153	4 Red	Clear	Carded	1 Pc./Card
37154	4 White	Clear	Carded	1 Pc./Card



1 SMD LED Mini Clearance/Marker Lights

- 1 SMD LED mini clearance/marker light with rubber grommet.
- Polycarbonate lens sonically sealed to housing to prevent moisture
- Requires a 3/4" diameter hole for installation
- Lifetime warranty

Item Number	LEDs	Lens	Package	Pack
36843	1 Amber	Amber	Carded	1 Pc./Card
36844	1 Red	Red	Carded	1 Pc./Card



3 LED Dual Function Mini Auxiliary/Utility/Light W/ Bezel

- 3 LED mini dual function clearance marker light with stainless steel bezel
- Requires a 3/4" diameter hole for installation
- Fits panels and bumpers up to 1/4" thick
- Includes plastic backing washer for mounting on thin body panels

Item Number	LEDs	Lens	Package	Pack
36600	3 Amber	Amber	Carded	1 Pc./Card
36601	3 Red	Red	Carded	1 Pc./Card
36602	3 Amber	Clear	Carded	1 Pc./Card
36603	3 Red	Clear	Carded	1 Pc./Card

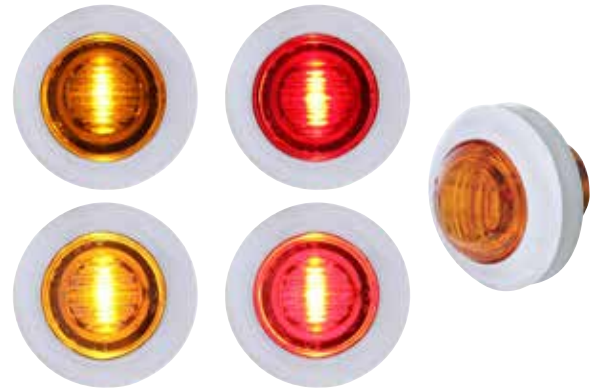

3 LED Mini Clearance/Marker Lights

- Requires a 13/16" opening, grommet mount, 7 1/2" wire lead
- Stainless bezel available separately: item # 20527B

Item Number	LEDs	Lens	Package	Pack
39767	3 Amber	Amber	Carded	1 Pc./Card
39768	3 Red	Red	Carded	1 Pc./Card
39769	3 Amber	Clear	Carded	1 Pc./Card
39770	3 Red	Clear	Carded	1 Pc./Card
39771	3 Blue	Clear	Carded	1 Pc./Card
39772	3 White	Clear	Carded	1 Pc./Card



3 LED Mini Clearance/Marker Lights - Stainless Steel

- Requires a 13/16" opening, grommet mount, 7 1/2" wire lead
- Stainless bezel available separately: item # 20527B

Item Number	LEDs	Lens	Light	Pack
39932	3 Amber	Amber	39767	1 Pc./Card
39933	3 Red	Red	39768	1 Pc./Card
39934	3 Amber	Clear	39769	1 Pc./Card
39935	3 Red	Clear	39770	1 Pc./Card
39936	3 Blue	Clear	39771	1 Pc./Card
39937	3 White	Clear	39772	1 Pc./Card



LED Bullet Fastener Lights

- 4 LED die-cast mini bullet marker light
- Universal application, mounts anywhere, perfect for trucks, 12 volt

Item Number	LEDs	Lens	Package	Pack
10863	1 Amber	Amber	Carded	2 Pcs./Card
10864	1 Blue	Blue	Carded	2 Pcs./Card
10867	1 Red	Red	Carded	2 Pcs./Card
10862	1 White	Clear	Carded	2 Pcs./Card



1 LED License Plate Fastener Lights (2 Pack)

- Super bright LED fastener with stainless steel housing
- Perfect for license plates, interior and under the hood lighting
- Includes nylon mounting nuts. Requires 5/16" diameter hole for installation
- 12 Volt DC. Easy hookup with 8 1/2" wire leads

Item Number	LEDs	Lens	Package	Pack
70300	1 Amber	Clear	Carded	2 Pcs./Card
70301	1 Blue	Clear	Carded	2 Pcs./Card
70302	1 Red	Clear	Carded	2 Pcs./Card
70303	1 White	Clear	Carded	2 Pcs./Card



1 LED Indicator Lights

- Indicator light with 1 super bright LED
- Requires 1/4" diameter hole for installation, 12 volt

Item Number	LEDs	Lens	Package	Pack
39314	1 Amber	Amber	Carded	1 Pc./Card
39314B	1 Amber	Amber	Bulk	1 Pc.
39315	1 Blue	Blue	Carded	1 Pc./Card
39315B	1 Blue	Blue	Bulk	1 Pc.
39316	1 Green	Green	Carded	1 Pc./Card
39316B	1 Green	Green	Bulk	1 Pc.
39317	1 Purple	Purple	Carded	1 Pc./Card
39317B	1 Purple	Purple	Bulk	1 Pc.
39318	1 Red	Red	Carded	1 Pc./Card
39318B	1 Red	Red	Bulk	1 Pc.
39319	1 White	Clear	Carded	1 Pc./Card
39319B	1 White	Clear	Bulk	1 Pc./Card



Mini Pilot Lights

- Simple wiring connection with 0.180" diameter ring terminal at wire end
- Requires 3/8" diameter mounting holes, universal application

Item Number	LEDs	Lens	Package	Pack
40051	1 Amber	Amber	Carded	2 Pcs./Card
40052	1 Blue	Blue	Bulk	2 Pcs./Card
40053	1 Green	Green	Carded	2 Pcs./Card
40055	1 Red	Red	Bulk	2 Pcs./Card



LED ACCESSORY LIGHTS
MISCELLANEOUS

21 High Power LED 6 1/4" Dome Light W/ Bezel

- 21 high power LED dome light with chrome plated bezel
- 6 1/4" round
- 12V/24V application

Item Number	LEDs	Lens	Package	Pack
37625B	21 White	Clear	Carded	1 Pc./Card



4 LED Dome Light With Chrome Bezel

- 4 super bright LED clear lens auxiliary light w/ chrome plastic bezel
- 2 wires (hard wired)
- Mounting holes are 2 3/16" apart

Item Number	LEDs	Lens	Package	Pack
38931	4 Amber	Clear	Carded	1 Pc./Card
38936	4 White	Clear	Carded	1 Pc./Card



3 LED 1" Dual Function Auxiliary/Utility Light W/ Visor

- 3 high power amber LED 1" auxiliary/utility light with visor

Item Number	LEDs	Lens	Package	Pack
36899	3 Amber	Amber	Carded	1 Pc./Card



5 LED Tab Mounting Auxiliary/Utility Light

- Super bright LEDs with high quality injection molded polycarbonate lens
- Easy hookup to any 12V DC system
- Clip attachment

Item Number	LEDs	Lens	Package	Pack
CTL4950LED	5 Red	Red	Carded	1 Pc./Card

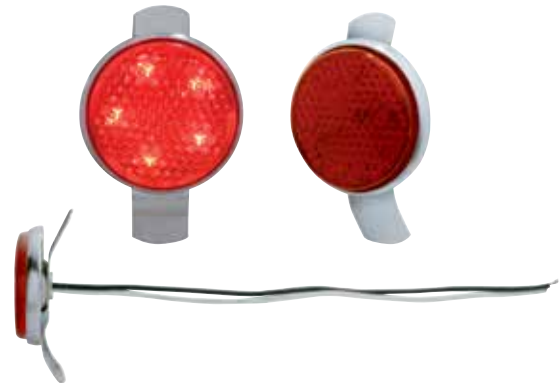

30 LED 19 1/2" Auxiliary/Utility Flex Strip Light

- Can be used as accent lighting under dash edges, arm rest, inside trunk and engine compartment
- Easily attaches with adhesive tape
- Not designed or warranted for exterior use

Item Number	LEDs	Package	Pack
37954	30 Amber	Carded	1 Pc./Card
37957	30 Red	Carded	1 Pc./Card

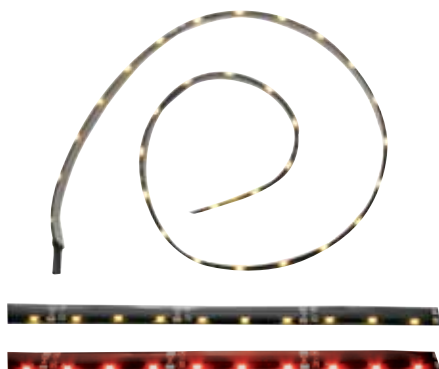

45 LED 35 1/4" Auxiliary/Utility Flex Strip Light

- 45 super bright LED flex strip light

Item Number	LEDs	Wire Exit	Package	Pack
37623	45 Red	Left	Carded	1 Pc./Card
37624	45 Red	Right	Carded	1 Pc./Card
37659	45 White	Left	Carded	1 Pc./Card
37660	45 White	Right	Carded	1 Pc./Card

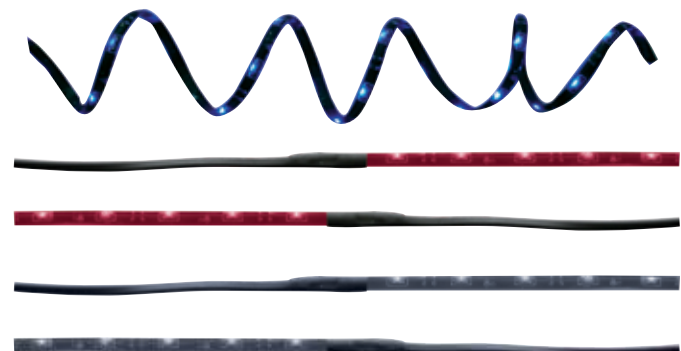

1 LED Snap-In Indicator Light

- Snap-in indicator light with 1 super bright LED
- Requires 1/4" diameter hole for installation
- 2 wire (hard wired), wire length approximately 7"

Item Number	LEDs	Lens	Package	Pack
36517B	1 Amber	Amber	Carded	1 Pc./Card
36518B	1 Blue	Clear	Carded	1 Pc./Card
36519B	1 Green	Green	Carded	1 Pc./Card
36520B	1 Red	Red	Carded	1 Pc./Card
36521B	1 White	Clear	Carded	1 Pc./Card



11 LED Slim Strip Light

- 11 high power white LED slim, low profile LED strip light

Item Number	LEDs	Lens	Package	Pack
37499B	11 White	Clear	Carded	1 Pc./Card



Bluetooth RGB Multi-Color 500 Lumen LED Rock Light

- Bluetooth app control with thousands of colors, dimming, strobe & beat to music on your IOS or Android device
- Plays millions of colors of light synchronized to the beat of the music from your smart phone
- Control & dim lights with RGB remote app
- CREE LED in a waterproof and aluminum housing
- Mounting pads & spacers, screws and instructions included
- Supports most iPhone, iPad and Android smartphones
- 500 lumens, 12V-24V multiple voltage
- Wire length: 11'
- Solids & Liquid protection rating: IP-67

Item Number	LEDs	Lens	Package	Pack
36604	1 Amber	Amber	Carded	1 Pc./Card



LED ACCESSORY LIGHTS
LED LIGHT BARS



19 LED 12" Reflector Turn Signal Light Bar

- 19 LED 12" P/T/C reflector light bar, approximate size 12" L x 5/8" W
- Mounting holes approximately 11 7/16" apart

Item Number	LEDs	Lens	Package	Pack
39773	19 Amber	Amber	Carded	1 Pc./Card
39773B	19 Amber	Amber	Bulk	1 Pc.
39774	19 Red	Red	Carded	1 Pc./Card
39774B	19 Red	Red	Bulk	1 Pc.
39775	19 Amber	Clear	Carded	1 Pc./Card
39775B	19 Amber	Clear	Bulk	1 Pc.
39776	19 Red	Clear	Carded	1 Pc./Card
39776B	19 Red	Clear	Bulk	1 Pc.

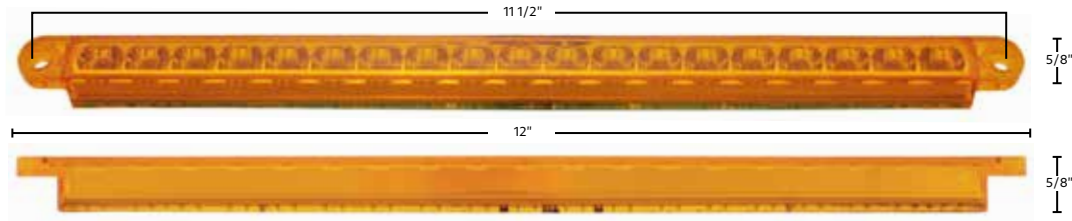

14 LED 12" Reflector Turn Signal Light Bar

- 14 LED 12" P/T/C strip light, 3 wire
- Mounting holes approximately 11 7/16" apart

Item Number	LEDs	Lens	Package	Pack
38946	14 Amber	Amber	Carded	1 Pc./Card
38946B	14 Amber	Amber	Bulk	1 Pc.
38947	14 Red	Red	Carded	1 Pc./Card
38947B	14 Red	Red	Bulk	1 Pc.
38948	14 Amber	Clear	Carded	1 Pc./Card
38948B	14 Amber	Clear	Bulk	1 Pc.
38949	14 Red	Clear	Carded	1 Pc./Card
38949B	14 Red	Clear	Bulk	1 Pc.
39483B	14 Blue	Clear	Bulk	1 Pc.
39484B	14 Green	Clear	Bulk	1 Pc.
39485B	14 White	Clear	Bulk	1 Pc.
39644B	14 Amber	Chrome	Bulk	1 Pc.
39645B	14 Red	Chrome	Bulk	1 Pc.

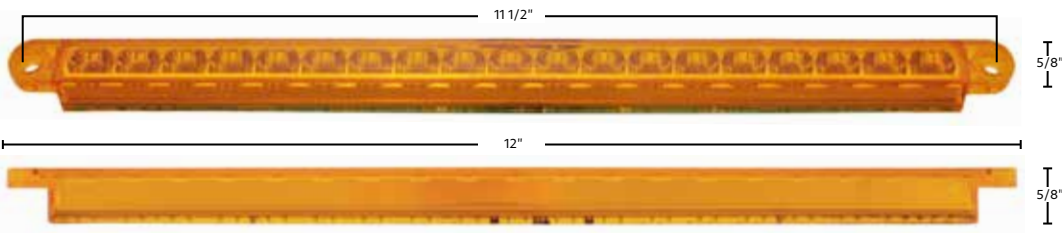

12 LED 12" Ultra Slim Turn Signal Light Bar

- Mounting holes approximately 11 1/2" apart

Item Number	LEDs	Lens	Package	Pack
38861B	12 Amber	Amber	Bulk	1 Pc.
38862B	12 Red	Red	Bulk	1 Pc.
38863B	12 Amber	Clear	Bulk	1 Pc.
38864B	12 Red	Clear	Bulk	1 Pc.

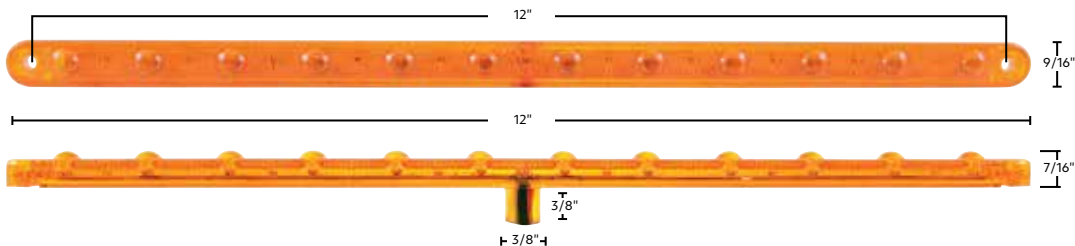

10 LED 9" Turn Signal Light Bar

- 10 LED 9" P/T/C strip light, 3 wire
- Mounting holes approximately 8 1/2" apart

Item Number	LEDs	Lens	Package	Pack
38942	10 Amber	Amber	Carded	1 Pc./Card
38942B	10 Amber	Amber	Bulk	1 Pc.
38943	10 Red	Red	Carded	1 Pc./Card
38943B	10 Red	Red	Bulk	1 Pc.
38944	10 Amber	Clear	Carded	1 Pc./Card
38944B	10 Amber	Clear	Bulk	1 Pc.
38945	10 Red	Clear	Carded	1 Pc./Card
38945B	10 Red	Clear	Bulk	1 Pc.
38005	10 White	Clear	Carded	1 Pc./Card

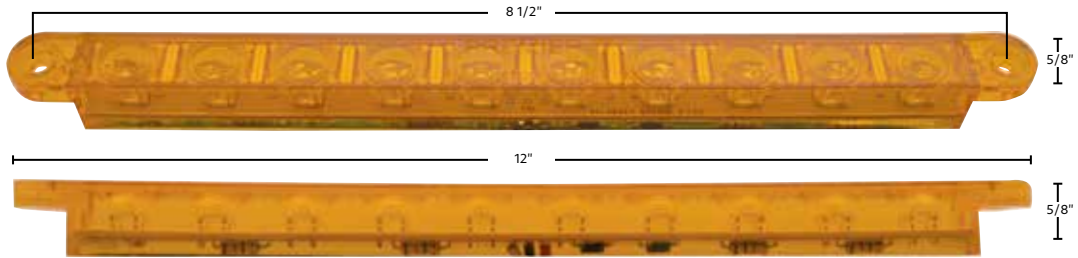
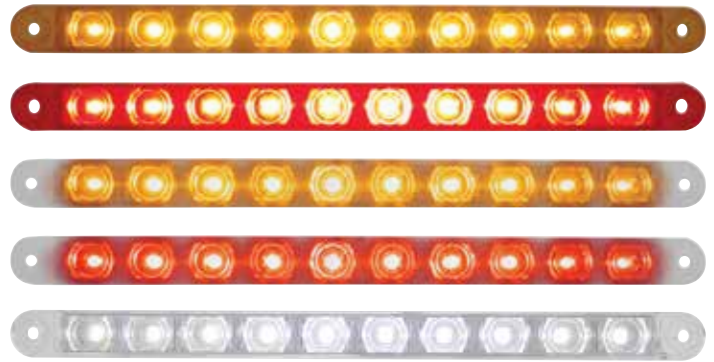

10 LED 6 1/2" Turn Signal Light Bar

- 10 LED 6 1/2" turn signal light bar, 3 wires (hard wired)
- Mounting holes approximately 6" apart

Item Number	LEDs	Lens	Package	Pack
39684B	10 Amber	Amber	Bulk	1 Pc.
39685	10 Red	Red	Carded	1 Pc./Card
39685B	10 Red	Red	Bulk	1 Pc.
39686	10 Amber	Clear	Carded	1 Pc./Card
39686B	10 Amber	Clear	Bulk	1 Pc.
39687	10 Red	Clear	Carded	1 Pc./Card
39687B	10 Red	Clear	Bulk	1 Pc.

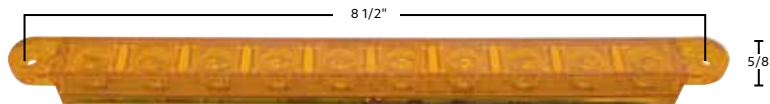
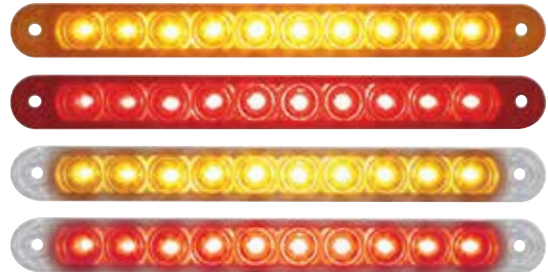

5 LED 5" Light Strip With Hard Wire

- 5 super bright SMD LED 5" light strip with fully sealed electronics
- 12VDC, dual function red or amber, or single function white
- Captive #6-32 nuts for rear flush mounted installation
- For clean and proper mounting, a 3-15/16x5/8" rectangular pocket is required, see line art for more dimensional details

Item Number	LEDs	Lens	Package	Pack
36446	5 Amber	Amber	Carded	1 Pc./Card
36447	5 Red	Red	Carded	1 Pc./Card
36448	5 White	Clear	Carded	1 Pc./Card

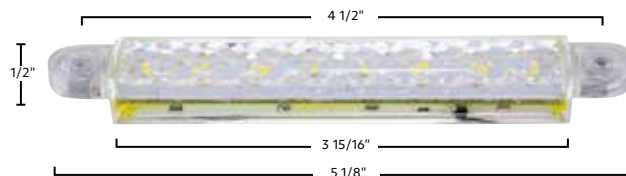

LED LIGHT BARS W/ BEZEL

19 LED 12" Reflector Turn Signal Light Bar With Bezel

- 19 LED 12" reflector light bar with chrome plastic bezel
- Stainless steel mounting hardware included
- Mounting screws can be moved to accommodate mounting distance from 4 1/2" - 7 3/8" apart
- 12" chrome plastic light bar bezel available separately: item # 30933B

Item Number	LEDs	Lens	Light	Pack
37940	19 Amber	Amber	39773B	1 Pc./Card
37941	19 Red	Red	39774B	1 Pc./Card
37942	19 Amber	Clear	39775B	1 Pc./Card
37943	19 Red	Clear	39776B	1 Pc./Card

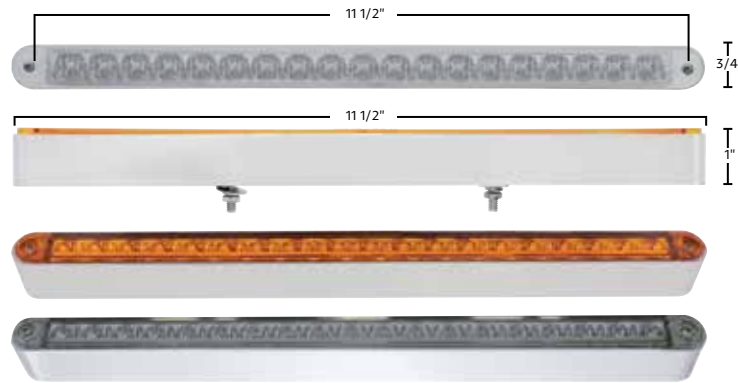

14 LED 12" Turn Signal Light Bar W/ Bezel

- 14 LED 12" light bar with chrome plastic bezel
- Stainless steel hardware included
- Mounting holes can be moved to accommodate mounting distance from 4 1/2" - 7 3/8" apart

Item Number	LEDs	Lens	Light	Pack
39606	14 Amber	Amber	38946B	1 Pc./Card
39608	14 Amber	Clear	38948B	1 Pc./Card
39607	14 Red	Red	38947B	1 Pc./Card
39609	14 Red	Clear	38949B	1 Pc./Card
39804	14 Blue	Clear	39483B	1 Pc./Card
39805	14 Green	Clear	39484B	1 Pc./Card
39806	14 White	Clear	39485B	1 Pc./Card
39698	14 Amber	Chrome	39644B	1 Pc./Card
39699	14 Red	Chrome	39645B	1 Pc./Card

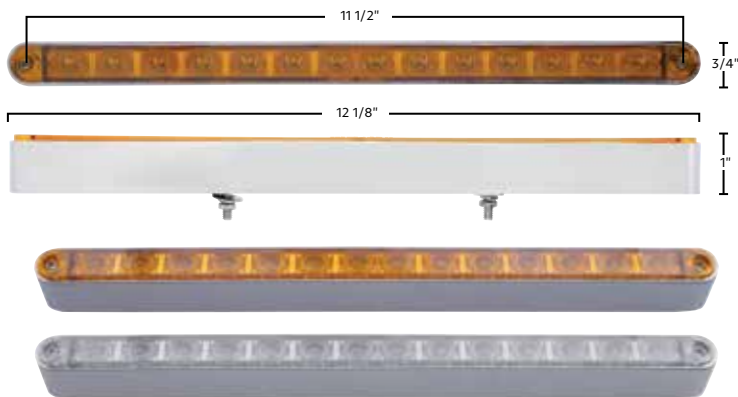

10 LED 9" Turn Signal Light Bar W/ Bezel

- 10 LED 9" light bar with quality polycarbonate lens
- Beautiful chrome plated plastic bezel
- Mounting screws can move to accommodate mounting distance from 4 1/2" - 7 3/8" apart

Item Number	LEDs	Lens	Light	Pack
39306	10 Amber	Amber	38942B	1 Pc./Card
39307	10 Red	Red	38943B	1 Pc./Card
39308	10 Amber	Clear	38944B	1 Pc./Card
39309	10 Red	Clear	38945B	1 Pc./Card

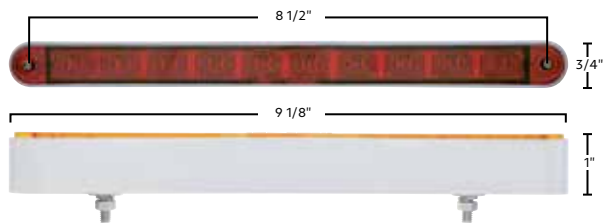

10 LED 6 1/2" Turn Signal Light Bar W/ Bezel

- 10 LED 6 1/2" light bar with quality polycarbonate lens
- Beautiful chrome plated plastic bezel
- Mounting screws can move to accommodate mounting distance from 2 1/4" - 4 7/8" apart

Item Number	LEDs	Lens	Light	Pack
37637	10 Amber	Amber	39684B	1 Pc./Card
37638	10 Red	Red	39685B	1 Pc./Card
37639	10 Amber	Clear	39686B	1 Pc./Card
37640	10 Red	Clear	39687B	1 Pc./Card

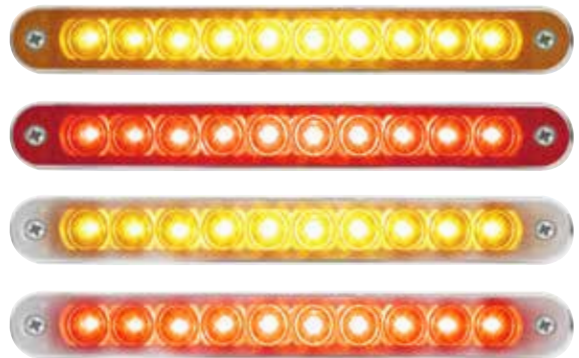
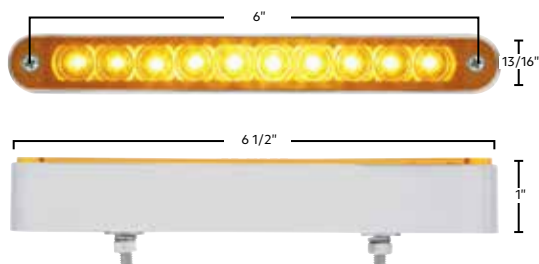

LED ACCESSORY LIGHTS
LED LICENSE LIGHT

19 LED 12" Light Bar Chrome License Plate Frame

- Beautiful high quality chrome plated finish with triple chrome plating process
- Designed for all 12V application

Item Number	LEDs	Lens	Package	Pack
37946	19 Amber	Amber	Bulk	1 Pc./Card
37947	19 Red	Red	Bulk	1 Pc./Card
37948	19 Red	Clear	Bulk	1 Pc./Card
37949	19 Red	Clear	Bulk	1 Pc./Card



14 LED Light Bar Chrome License Plate Frame

- Beautiful high quality chrome plated finish with triple chrome plating process
- Designed for all 12V application

Item Number	LEDs	Lens	Package	Pack
39743	14 Amber	Amber	Bulk	1 Pc./Card
39744	14 Red	Red	Bulk	1 Pc./Card
39781	14 White	Clear	Bulk	1 Pc./Card

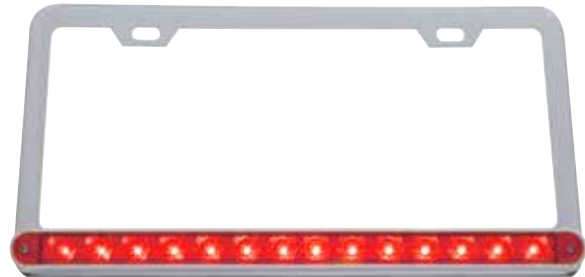
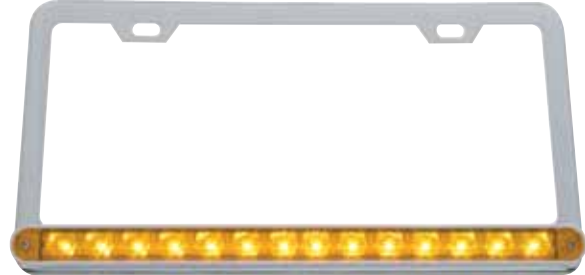

14 LED Dual Light Bar Chrome License Plate Frame

- 14 super bright white LEDs with clear polycarbonate lens
- Solid state circuit boards are designed for 7.7-14.0V DC, 1156 plug
- Perfect solution for back-up lights on Corvettes converted to 4 tail lights, hardware included

Item Number	LEDs	Lens	Package	Pack
50121	14 White	Clear	Carded	1 Pc./Card
50122	14 Red	Clear	Carded	1 Pc./Card



10 LED Chrome Deluxe License Plate Frame

- Beautiful chrome plated finish with triple chrome plating process
- New deluxe vintage style with 10 white LEDs and clear lens
- Designed for all 12V applications

Item Number	LEDs	Lens	Package	Pack
36541	10 White	Clear	Carded	1 Pc./Card



LED Chrome License Plate Frame W/ LED Auxiliary Light

- Deluxe chrome license plate frame with LED back-up light and white LED license light
- Beautiful chrome die cast metal light housing with 5 LED light, and 11 LED license plate light
- Fits standard U.S. & Canadian 6" x 12" license plates
- Overall frame dimension 12-5/16" x 6-3/8"

Item Number	LEDs	Lens	Package	Pack
50148	5 Red/10 White	White	Carded	1 Pc./Card
50149	5 Amber/10 White	Amber	Carded	1 Pc./Card
50187	5 White/10 White	White	Carded	1 Pc./Card



10 LED 9" Light Bar Chrome License Plate Frame

- Beautiful high quality chrome plated finish with triple chrome plating process
- Designed for all 12V application

Item Number	LEDs	Lens	Package	Pack
39755	10 Amber	Amber	Bulk	1 Pc.
39756	10 Red	Red	Bulk	1 Pc.
39757	10 Amber	Clear	Bulk	1 Pc.
39758	10 Red	Clear	Bulk	1 Pc.

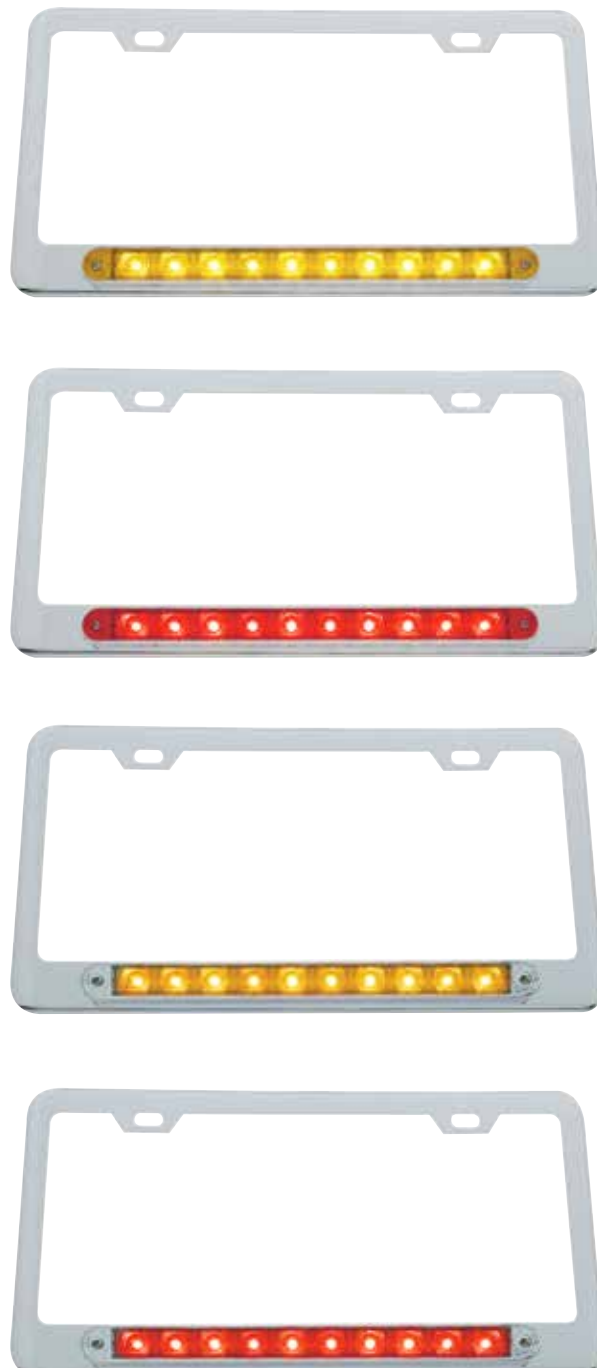

LED ACCESSORY LIGHTS
LED LICENSE LIGHT

Chrome License Plate Frame W/ 24 LED GLO Light

- Beautiful high quality chrome plated finish with triple chrome plating process
- Easy hookup to your existing brake light switch, 12V application
- Fits standard U.S. & Canadian 6" x 12" license plates

Item Number	LEDs	Lens	Package	Pack
36497	24 Red	Red	Carded	1 Pc./Card
36498	24 Red	Clear	Carded	1 Pc./Card



Black License Plate Frame W/ 24 LED GLO Light

- Gloss black powder coated plastic license plate frame and plastic light bar housing
- 12V application, easy hookup to your existing auxiliary wiring
- Fits standard U.S. & Canadian 6" x 12" license plates

Item Number	LEDs	Lens	Package	Pack
36480	24 Amber	Amber	Carded	1 Pc./Card
36482	24 Amber	Clear	Carded	1 Pc./Card
36481	24 Red	Red	Carded	1 Pc./Card
36483	24 Red	Clear	Carded	1 Pc./Card



Chrome Deluxe License Plate W/ Split Turn Function

- Chrome license plate with 10 LED 9 split turn function light bar
- Dual function 10 LED running light & 5 LED left hand & 5 LED right hand turn signal
- Easy electrical hookup w/ 4 wires: ground, tail, L/H high, R/H high
- Includes stainless steel mounting hardware

Item Number	LEDs	Lens	Package	Pack
39397	10 Red	Red	Carded	1 Pc./Card



14 LED Black License Plate Frame W/ 12" Light Bar

- Gloss black powder coated plastic license plate frame and plastic light bar housing
- 12V application, easy hookup to your existing auxiliary wiring
- Fits standard U.S. & Canadian 6" x 12" license plates

Item Number	LEDs	Lens	Package	Pack
36472	14 Amber	Amber	Carded	1 Pc./Card
36474	14 Amber	Clear	Carded	1 Pc./Card
36473	14 Red	Red	Carded	1 Pc./Card
36475	14 Red	Clear	Carded	1 Pc./Card
36496	14 White	Clear	Carded	1 Pc./Card



19 LED Black License Plate Frame W/ 12" Light Bar

- Gloss black powder coated plastic license plate frame and plastic light bar housing
- 12V application, easy hookup to your existing auxiliary wiring
- Fits standard U.S. & Canadian 6" x 12" license plates

Item Number	LEDs	Lens	Package	Pack
36476	19 Amber	Amber	Carded	1 Pc./Card
36478	19 Amber	Clear	Carded	1 Pc./Card
36477	19 Red	Red	Carded	1 Pc./Card
36479	19 Red	Clear	Carded	1 Pc./Card



LED ACCESSORY LIGHTS
LED LICENSE LIGHT

6 LED Stainless Steel Tube Light

- 6 LED stainless tube light, universal application, install anywhere
- Highly polished 304 stainless steel finish for durability and shine
- Mounting studs are approximately 8" apart
- Designed for all 12V application, 2 wires (hard wired)

Item Number	LEDs	Lens	Package	Pack
37586	6 Amber	Clear	Carded	1 Pc./Card
37587	6 Blue	Clear	Carded	1 Pc./Card
37588	6 Red	Amber	Carded	1 Pc./Card



6 LED Stainless Steel Tube Light

- 6 LED stainless tube light, universal application, install anywhere
- Highly polished 304 stainless steel finish for durability and shine
- Mounting studs are approximately 8" apart
- Designed for all 12V application, 2 wires (hard wired)

Item Number	LEDs	Lens	Package	Pack
S2008LED	6 White	Clear	Carded	1 Pc./Card

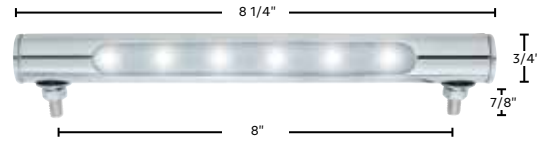

2 LED Chrome License Plate Light/Utility Light

- 2 super bright white LED license/utility light, 12 volt
- Water resistant chrome housing
- Includes mounting screws and pad
- Mounting screws are 5-1/2" apart

Item Number	LEDs	Lens	Package	Pack
39909	2 White	Clear	Carded	1 Pc./Card



4 LED License Light

- 4 super bright LED utility/license light
- Chrome housing, water resistant
- Install anywhere
- 2 wires (hard wired)

Item Number	LEDs	Lens	Package	Pack
39930	4 White	Clear	Carded	1 Pc./Card



2 LED License Light

- 2 white LED auxiliary/license light

Item Number	LEDs	Lens	Package	Pack
39994B	2 White	Clear	Carded	1 Pc./Card





11 LED Chrome License Plate Frame

- Show quality chrome plated die-cast license bracket
- 11 bright white LED license plate light
- 5 bright LED rear facing auxiliary light
- Mounts to any surface with 2 mounting studs on back

Item Number	LEDs	Lens	Package	Pack
S2007LED-A	11 White/5 Amber	Amber	Carded	1 Pc./Card
S2007LED	11 White/5 Red	Red	Carded	1 Pc./Card
S2007LED-W	11 White/5 White	Clear	Carded	1 Pc./Card



11 LED Chrome License Plate Light

- Beautiful chrome die-cast art-deco design light housing
- 11 bright white LED license plate light
- 5 bright LED rear facing auxiliary light
- Mounting screws are 5-1/2" apart
- Includes mounting pad with lip and mounting hardware

Item Number	LEDs	Lens	Package	Pack
110265	11 White/5 Amber	Amber	Carded	1 Pc./Card
110203	11 White/5 Red	Red	Carded	1 Pc./Card
110204	11 White/5 White	Clear	Carded	1 Pc./Card



4 LED Round License Light

- 4 bright white LED round license plate light, simple universal auxiliary license plate light design
- Requires 12V power and can be mounted horizontal, vertical, on or off the license plate frame

Item Number	LEDs	Lens	Package	Pack
39995B	4 White	Clear	Carded	1 Pc./Card



LED LIGHT BULBS 1157 BULBS

2 High Power LED 1157 Bulbs

- Bright 2 watt Osram LED, 250 lumens
- Double contact, offset pin

Item Number	LEDs	Lens	Package	Pack
36932	2	Amber	Carded	1 Pc./Card
36934	2	Red	Carded	1 Pc./Card
36935	2	White	Carded	1 Pc./Card



High Power 1157 LED Bulb

- Dual function LED bulb: high 275 lumens/low 150 lumens
- 360 degrees surround illumination, 180 degree front illumination
- Long life sealed design

Item Number	LEDs	Lens	Package	Pack
36469	1 Amber	Amber	Carded	1 Pc./Card
36470	1 Red	Red	Carded	1 Pc./Card
36471	1 White	White	Carded	1 Pc./Card

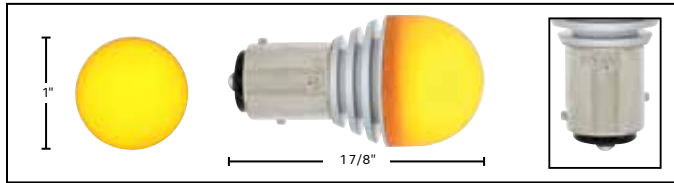

13 LED 360 Degree 1157 Bulb

- 13 LED 360 degree 1157 bulb
- 1157 double contact, offset pin

Item Number	LEDs	Lens	Package	Pack
39862	13 Amber	Amber	Carded	1 Pc./Card
39864	13 White	White	Carded	1 Pc./Card

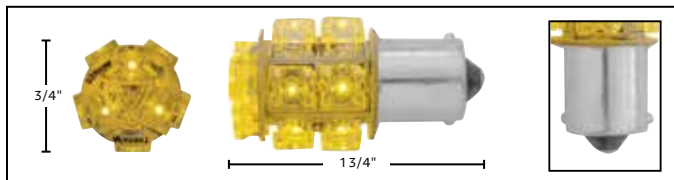

8 High Power LED 1157 Bulb (2 Pack)

- 8 high power SMD LED's, 50 lumens/150/lumens
- Replaces most #1157 and #P21/5W applications
- 12 volt, double contact with off-set pins

Item Number	LEDs	Lens	Package	Pack
36445	8 Amber	Amber	Carded	2 Pcs./Card
36444	8 Red	Red	Carded	2 Pcs./Card
36443	8 White	White	Carded	2 Pcs./Card

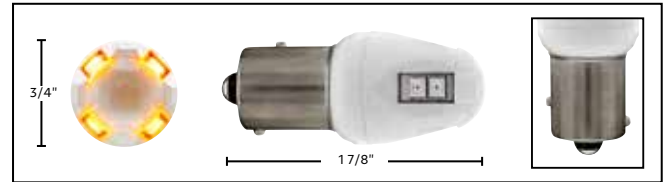

30 LED Right Angle 1157 Bulb

- Epoxy coated fully sealed electronics
- Double contact, offset pin

Item Number	LEDs	Lens	Package	Pack
38788	30	Amber	Carded	1 Pc./Card

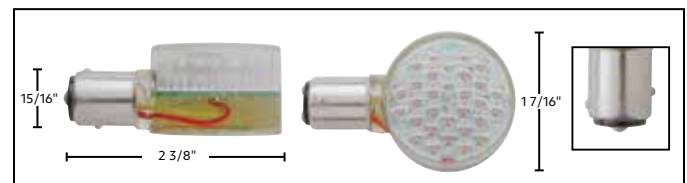

8 High Power LED 1156 Bulb (2 Pack)

- 8 high power SMD LED's, 250 lumens
- Replaces most #1156 and #89 applications
- 12 volt, single contact straight across pins

Item Number	LEDs	Lens	Package	Pack
38899	8 Amber	Amber	Carded	2 Pcs./Card
38898	8 Red	Red	Carded	2 Pcs./Card
38897	8 White	Amber	Carded	2 Pcs./Card

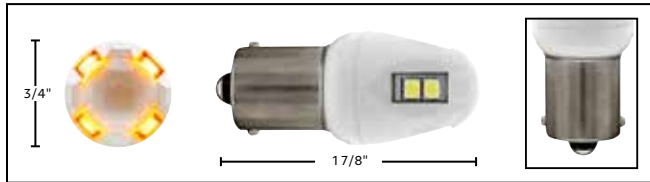

30 LED Right Angle 1156 Bulb

- Epoxy coated fully sealed electronics
- Single contact, straight pin

Item Number	LEDs	Lens	Package	Pack
38790	30	Amber	Carded	1 Pc./Card

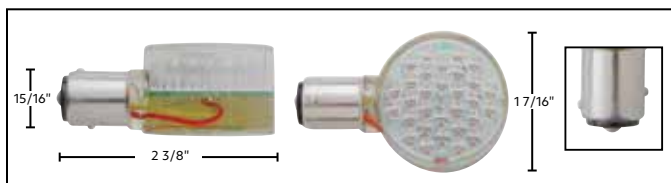

2 High Power LED 1156 Bulbs

- Bright 2 watt Osram LED, 250 lumens
- Single contact, straight pin

Item Number	LEDs	Lens	Package	Pack
36928	2	Amber	Carded	1 Pc./Card
36930	2	Red	Carded	1 Pc./Card
36931	2	White	Carded	1 Pc./Card



High Power 1156 LED Bulb

- Single function LED bulb with maximum 275 lumens
- 360 degrees surround illumination, 180 degree front illumination
- Long life sealed design

Item Number	LEDs	Lens	Package	Pack
36465	1 Amber	Amber	Carded	1 Pc./Card
36466	1 Red	Red	Carded	1 Pc./Card
36467	1 White	White	Carded	1 Pc./Card

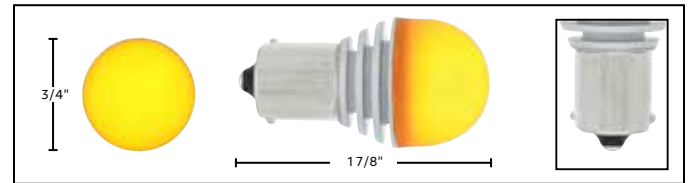

13 LED 360 Degree 1156 Bulb

- 13 LED 360 degree 1156 bulb
- 1156 single contact, straight pin

Item Number	LEDs	Lens	Package	Pack
39865	13 Amber	Amber	Carded	1 Pc./Card

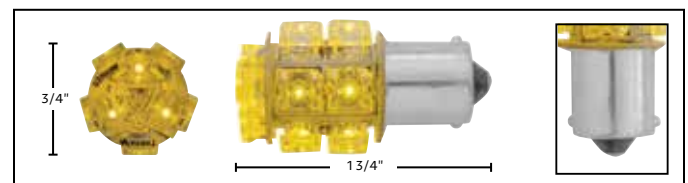

LED LIGHT BULBS
194 BULBS

4 LED 194 Bulb (3 Pack)

- Standard 194 wedge base
- Deluxe packaging with 3 bulbs per card

Item Number	LEDs	Lens	Package	Pack
38272	4	Amber	Carded	3 Pcs./Card
38273	4	Blue	Carded	3 Pcs./Card
38274	4	Green	Carded	3 Pcs./Card
38276	4	Red	Carded	3 Pcs./Card
38277	4	White	Carded	3 Pcs./Card

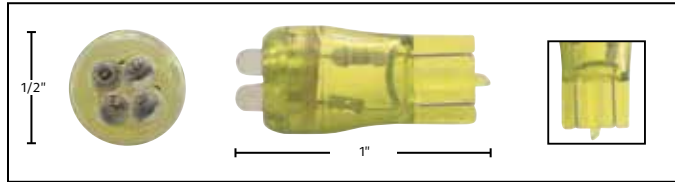

1 LED 194 Bulb (2 Pack)

- Single Cree LED
- Single contact, straight pin

Item Number	LEDs	Lens	Package	Pack
36917	1 Amber	Clear	Carded	2 Pcs./Card
36918	1 Blue	Clear	Carded	2 Pcs./Card
36919	1 Red	Clear	Carded	2 Pcs./Card
36920	1 White	Clear	Carded	2 Pcs./Card



1 Micro LED 37/BP2 Bulb (2 Pack)

- Popular on most dash applications
- Standard 37/bp2 wedge base

Item Number	LEDs	Lens	Package	Pack
38343	1	Amber	Carded	2 Pcs./Card
38344	1	Blue	Carded	2 Pcs./Card
38345	1	Green	Carded	2 Pcs./Card
38346	1	Purple	Carded	2 Pcs./Card
38348	1	White	Carded	2 Pcs./Card



4 Micro LED 194 Bulb (2 Pack)

- Standard 194 wedge base

Item Number	Micro LEDs	Lens	Package	Pack
38288	4 Purple	Purple	Carded	2 Pcs./Card

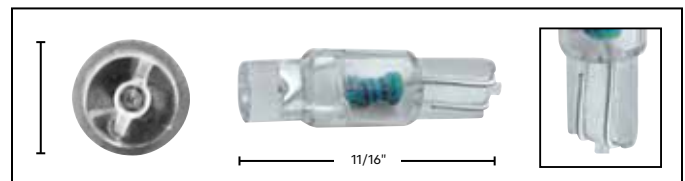



13 LED 3157 Bulb

- Epoxy coated fully sealed electronics
- Single contact, straight pin

Item Number	LEDs	Lens	Package	Pack
37800	5	Amber	Carded	2 Pcs./Card
37801	5	Blue	Carded	2 Pcs./Card
37802	5	Red	Carded	2 Pcs./Card
37803	5	White	Carded	2 Pcs./Card

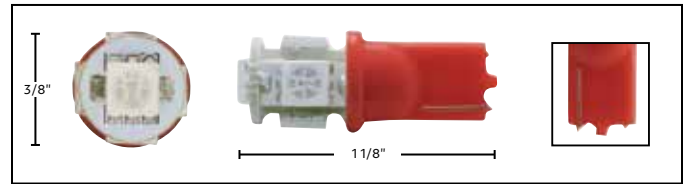

2 High Power LED 3157 Bulb

- Super bright 2W LED
- Output rated at 250 lumens
- 3157 wedge base

Item Number	LEDs	Lens	Package	Pack
36547	4 Amber	Clear	Carded	1 Pc./Card
36549	4 Red	Clear	Carded	1 Pc./Card
36550	4 White	Clear	Carded	1 Pc./Card



2 High Power LED 3156 Bulb

- Super bright 2W LED
- Output rated at 250 lumens
- 3156 wedge base

Item Number	LEDs	Lens	Package	Pack
36543	2 Amber	Amber	Carded	1 Pc./Card
36545	2 Red	Red	Carded	1 Pc./Card
36546	2 White	Clear	Carded	1 Pc./Card



LED LIGHT BULBS
1893/211-1/912 BULBS

1 LED 1893 Bulb (2 Pack)

- 1893 bulb with 1 large 10mm LED bulb
- Single contact, straight pin

Item Number	LEDs	Lens	Package	Pack
38565	1	White	Carded	2 Pcs./Card

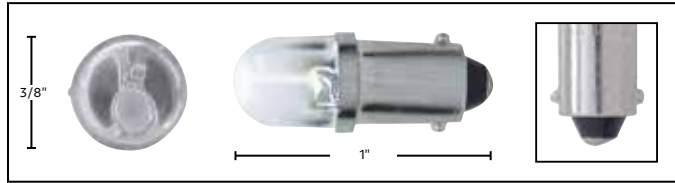

4 Micro LED 1893 Bulb (2 Pack)

- 1893 bulb with 4 micro LED bulbs, single contact, straight pin

Item Number	Micro LEDs	Lens	Package	Pack
38566	4	Amber	Carded	2 Pcs./Card
38567	4	Blue	Carded	2 Pcs./Card
38568	4	Green	Carded	2 Pcs./Card
38570	4	Red	Carded	2 Pcs./Card
38571	4	White	Carded	2 Pcs./Card



7 White LED 912/921 Bulb

- 912/921 wedge base, also fits 194 socket
- Light output is estimated at 34 lumens

Item Number	LEDs	Lens	Package	Pack
36504	7 White	White	Carded	1 Pc./Card

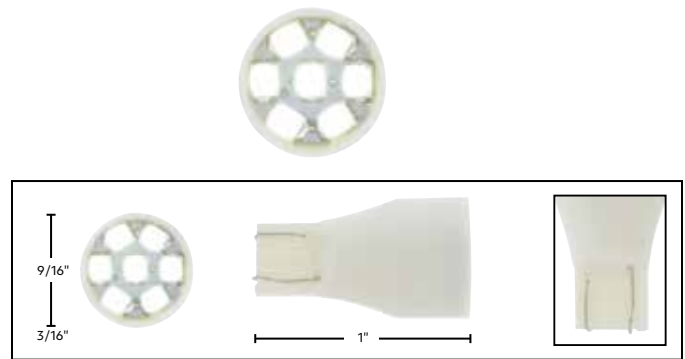

6 SMD High Power LED 6418-6461 36mm Bulb (2 Pack)

- Standard T-3 festoon base
- Specially designed bulb projects light 160 degrees

Item Number	LEDs	Lens	Package	Pack
36591	6 Amber	Amber	Carded	2 Pcs./Card
36592	6 Blue	Blue	Carded	2 Pcs./Card
36593	6 Red	Red	Carded	2 Pcs./Card
36594	6 White	White	Carded	2 Pcs./Card

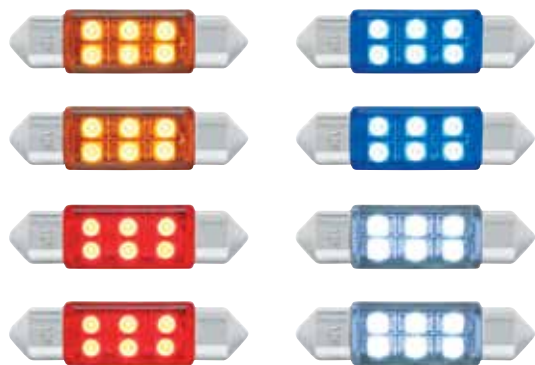

8 SMD High Power LED 211-1 Bulb (2 Pack)

- Perfect upgrade for dome lights that use a 211-2 bulb
- Specially designed bulb projects light 160 degrees
- Standard T-3 festoon base, 43.7mm length, 8.5mm dia, 12VDC

Item Number	LEDs	Lens	Package	Pack
36595	8 Amber	Amber	Carded	2 Pcs./Card
36596	8 Blue	Blue	Carded	2 Pcs./Card
36597	8 Red	Red	Carded	2 Pcs./Card
36598	8 White	White	Carded	2 Pcs./Card



LED Flasher W/ Reverse Polarity Base & Extension Wires

- Designed for all 12V applications, 20 amp maximum
- Solves turn signal problems, such as hyper flashing, no flashing, or burnt out bulb indication when using LED lights and bulbs
- Includes polarity reversing base & extension wires

Item Number	Description	Package	Pack
90649	LED Flasher - 2 Terminal	Carded	1 Pc./Card



LED Flashers - 12V, Terminal

- For use with all vehicles that are changed to LED tail lights and front turn signals
- Single contact, straight pen

Item Number	Description	Package	Pack
90650	LED Flasher - 2 Terminal	Carded	1 Pc./Card
90651	LED Flasher - 3 Terminal	Carded	1 Pc./Card



LED Flasher With Polarity Reversing Adapter 12V

- For use with all vehicles that are changed to LED tail lights and front turn signals, plug & play
- Simply replaces the original 552, or 536 under dash flasher
- Includes 2-terminal flasher (90650), polarity reversing adapter (90650a)
- Polarity reversing adapter solves reversed issues on some applic.

Item Number	Description	Package	Pack
90652	12V Flasher & Adapter	Carded	1 Pc./Card



Sequential LED Light Kit

- This kit will convert three 12 volt LED tail lights to sequential operation
- Kit includes two sequencer modules, hookup wire, wire connectors and instructions
- Designed for pre 1970's classic applications
- Also works with United Pacific LED tail lights for 1969 Camaro, 1967-68 Mustang and 1969 Mustang
- Not for use on vehicles with factory cruise control, alarm systems, or ABS brakes
- Not for use on vehicles that tow trailer, and not for use on trailers
- Not for use with incandescent light bulbs (LED only)
- Installation requires knowledge of automotive electrical systems

Item Number	Description	Package	Pack
90656	Sequential Light Kit	Kit	1 Kit

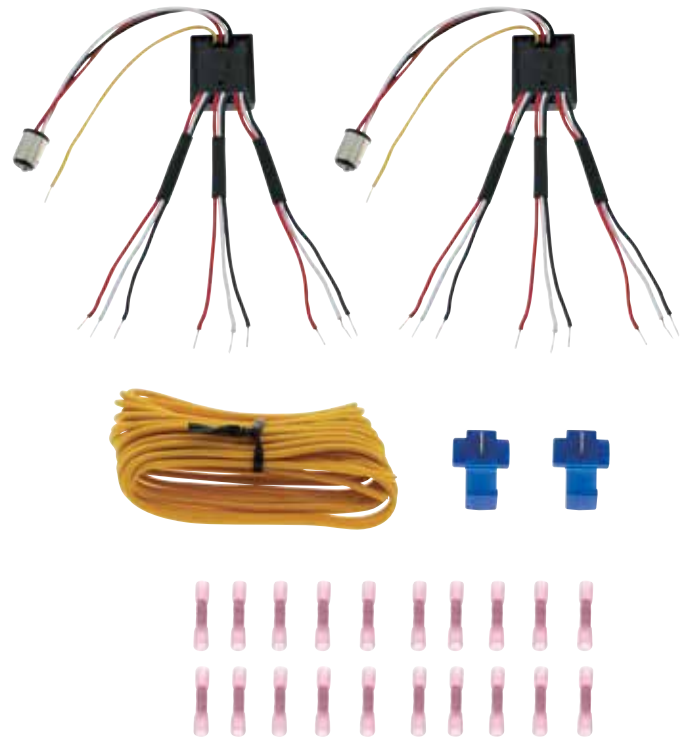

Polarity Reversing Adapter

- Polarity reversing adapter for UP 90650 turn signal flasher
- Reverses "X" and "I" terminals without modifying vehicle wiring

Item Number	Description	Package	Pack
90650A	Polarity Adapter	Carded	1 Pc./Card



FLASHERS/LOAD RESISTORS

Load Resistor - 50 Watt, 6 OHM

- Sends higher amperage to headlights
- Corrects dim lights on classic cars and hot rods
- Works on original style 6014 sealed beams
- Select proper kit to match your type of headlamp bulbs
- 12 volt application

Item Number	Description	Package	Pack
34263	H4 Relay Harness	Bulk	1 Pc.
34264	9005/9006 Relay Harness	Bulk	1 Pc.
34265	9007 Relay Harness	Bulk	1 Pc.

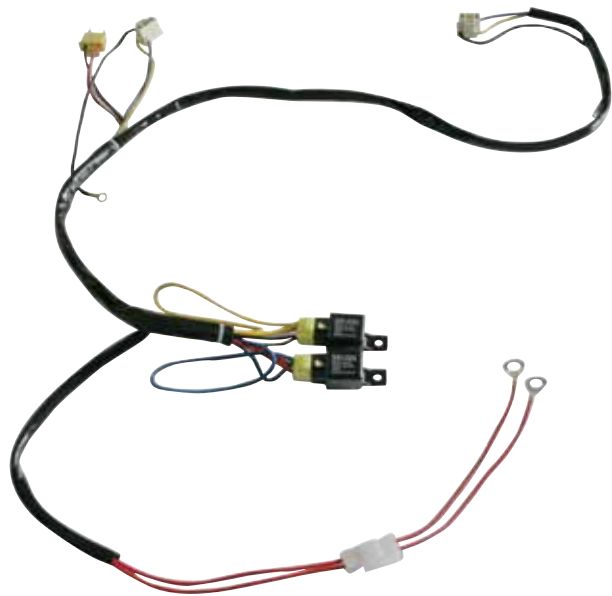

Load Resistor - 50 Watt, 6 OHM

- Simulate the load of an incandescent bulb
- Eliminate LED turn signal and LED headlight problems, such as hyper flashing, no flashing or burnt out bulb indication
- Aluminum housing with proprietary heat management allows installation in most locations
- Mounting hardware included
- Includes one load resistor and 2 connectors

Item Number	Description	Package	Pack
34205	Load Resistor	Carded	1 Pc./Card

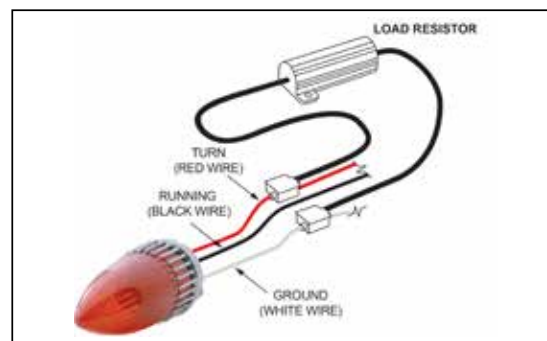

Brake Attention Module

- Upon applying the brakes, this electronic device rapidly flashes the third brake light (or both brake lights) for a second or two to gain the attention of the driver behind you
- Maximum capacity of 1.5 amp
- Easy hookup instructions included, 12 volt

Item Number	Description	Package	Pack
90655	Polarity Adapter	Carded	1 Pc./Card

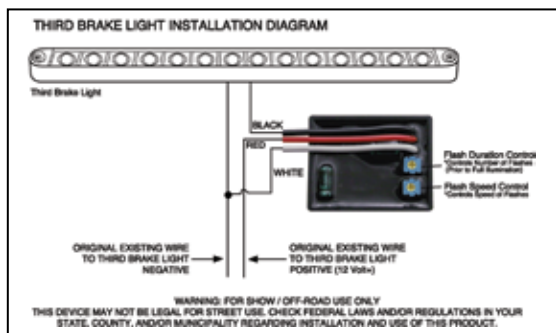

Load Resistor Kit Solves LED Issue - 50 Watt/6 OHM

- 50W/6 OHM LED load resistors for LED turn signal lights or LED license plate lights
- Eliminate LED turn signal problems, such as hyper flashing, no flashing, or burnt out bulb indication
- Simulates the load of an incandescent bulb to solve LED issues
- Aluminum housing with proprietary heat management allows installation in most locations
- Kit includes two load resistors and 4 connectors

Item Number	Description	Package	Pack
34235	Load Resistor Kit	Box	2 Pcs./Box



Fog Lamp Wiring Harness

- Complete wire harness from dash switch fog lamps
- Relay safety handles high amperage draw from fog lights
- 12 volt application

Item Number	Description	Package	Pack
34266	Fog Lamp Wiring Harness	Carded	1 Pc./Card



72" Chrome Plastic Wire Looms

1/4" Diameter

Item Number	Diameter	Color	Package	Pack
34800	1/4"	Chrome	Hang Pack	1 Pc./Pack

3/8" Diameter

Item Number	Diameter	Color	Package	Pack
34801	3/8"	Chrome	Hang Pack	1 Pc./Pack

1/2" Diameter

Item Number	Diameter	Color	Package	Pack
34802	1/2"	Chrome	Hang Pack	1 Pc./Pack

5/8" Diameter

Item Number	Diameter	Color	Package	Pack
34803	5/8"	Chrome	Hang Pack	1 Pc./Pack

3/4" Diameter

Item Number	Diameter	Color	Package	Pack
34804	3/4"	Chrome	Hang Pack	1 Pc./Pack



LED Flasher/Warning Module With 24 Flash Patterns

- Converts regular LED lights into flashing warning lights
- 24 selectable flash patterns, sync or alternating flash
- 12V application, 2 outputs, 20 amp max draw
- 1 module works with 2 LED lights

Item Number	Description	Package	Pack
90660	LED Warning Module	Carded	1 Pc./Card



LED Flasher/Warning Module With 15 Flash Patterns

- LED for warning module for use with one LED
- Converts regular LED lights into flashing warning lights
- 15 selectable flash patterns
- Designed for all 12V applications, 5 amp maximum LED load

Item Number	Description	Package	Pack
90661	LED Warning Module	Carded	1 Pc./Card



Plug Adaptor For Tail Lamp Socket

- 3 wire 1157 double contact plug adaptor with 5' of wire
- and 2 wire 1156 single contact style adaptor with 5' of wire

Item Number	Description	Package	Pack
FTL1157-PLUG	3 Wire Plug	Bag	1 Pc./Bag
FTL1156-PLUG	2 Wire Plug	Bag	1 Pc./Bag



100" Chrome Plastic Wire Looms

1/4" Diameter

Item Number	Diameter	Color	Package	Pack
34815	1/4"	Chrome	Hang Pack	1 Pc./Pack

3/8" Diameter

Item Number	Diameter	Color	Package	Pack
34816	3/8"	Chrome	Hang Pack	1 Pc./Pack

1/2" Diameter

Item Number	Diameter	Color	Package	Pack
34817	1/2"	Chrome	Hang Pack	1 Pc./Pack



PRODUCT INDEX

ITEM #	PAGE #	ITEM #	PAGE #	ITEM #	PAGE #	ITEM #	PAGE #	ITEM #	PAGE #
10862	142	31704	27	32654	30	34803	162	36603	141
10863	142	31705	27	32655	14	34804	162	36604	144
10864	142	31707	29	32658	16	34815	162	36673	136
10867	142	31710	29	32659	16	34816	162	36675	136
31084	10	31711	29	32660	30	34817	162	36676	136
31087	32	31725	29	32661	30	36443	155	36833	139
31088	36	31726	29	32662	30	36444	155	36843	141
31089	36	31734	28	32663	30	36445	155	36844	141
31120	33	31735	28	32668	23	36446	146	36859	137
31150	34	31737	28	32670	24	36447	146	36860	137
31151	34	31738	28	32674	26	36448	146	36888	40
31152	34	31740	28	32675	26	36449	33	36899	143
31153	34	31741	28	32676	25	36450	33	36903	41
31168	35	31752	31	32677	23	36452	10	36904	41
31169	35	31753	31	32681	23	36465	156	36917	157
31200	8	31755	27	32682	23	36466	156	36918	157
31201	12	31758	19	32683	24	36467	156	36919	157
31202	12	31767	31	32684	24	36468	40	36920	157
31237	35	31768	31	32688	26	36469	155	36927	41
31238	35	31770	27	32689	26	36470	155	36928	156
31247	11	31771	27	32690	25	36471	155	36930	156
31259	12	31773	19	32691	24	36472	152	36931	156
31267	12	32035	14	32695	21	36473	152	36932	155
31274	36	32043	14	32696	21	36474	152	36934	155
31275	36	32047	14	32744	21	36475	152	36935	155
31284	10	32059	16	32745	21	36476	152	37151	141
31285	10	32326	138	32760	21	36477	152	37153	141
31289	8	32329	138	32761	21	36478	152	37154	141
31297	32	32425	15	32762	20	36479	152	37308	138
31353	9	32429	15	32763	17	36480	151	37586	153
31355	9	32437	15	32766	19	36481	151	37587	153
31358	37	32441	15	32767	19	36482	151	37588	153
31359	37	32452	17	32769	20	36483	151	37623	143
31365	34	32453	17	32770	20	36496	152	37624	143
31368	38	32456	18	32771	17	36497	151	37637	148
31369	38	32457	18	32774	19	36498	151	37638	148
31372	42	32464	18	32775	19	36504	159	37639	148
31373	38	32465	18	32777	20	36512	40	37640	148
31374	38	32468	17	33010	139	36513	40	37659	143
31375	36	32469	17	34122	32	36541	149	37660	143
31376	36	32480	18	34125	37	36543	158	37800	158
31378	11	32481	18	34131	39	36545	158	37801	158
31379	11	32508	14	34132	39	36546	158	37802	158
31391	9	32509	14	34133	39	36547	158	37803	158
31396	37	32511	22	34134	39	36549	158	37940	147
31397	37	32512	22	34205	161	36550	158	37941	147
31458	8	32519	22	34222	42	36591	159	37942	147
31459	8	32520	22	34235	161	36592	159	37943	147
31496	7	32527	22	34263	42	36593	159	37946	149
31513	9	32528	22	34263	161	36594	159	37947	149
31514	9	32553	22	34264	42	36595	159	37948	149
31555	31	32554	22	34264	161	36596	159	37949	149
31570	16	32557	15	34265	161	36597	159	37954	143
31571	16	32558	15	34266	162	36598	159	37957	143
31574	27	32559	15	34800	162	36600	141	37961	63
31575	27	32639	31	34801	162	36601	141	37961	139
31584	26	32653	30	34802	162	36602	141	38005	146

PRODUCT INDEX

ITEM #	PAGE #
38021	140
38272	157
38273	157
38274	157
38276	157
38277	157
38288	157
38343	157
38344	157
38345	157
38346	157
38348	157
38375	136
38376	136
38377	136
38379	136
38380	136
38389	136
38436	135
38437	135
38438	135
38439	135
38440	135
38441	135
38442	135
38443	135
38444	134
38445	134
38446	134
38447	134
38450	140
38451	140
38453	140
38454	140
38492	133
38493	133
38494	133
38496	133
38497	133
38498	133
38565	159
38566	159
38567	159
38568	159
38570	159
38571	159
38595	134
38596	134
38597	134
38598	134
38788	155
38790	156
38812	114
38814	114
38820	133
38824	133
38825	133

ITEM #	PAGE #
38840	138
38841	138
38842	138
38843	138
38853	138
38855	138
38856	138
38897	156
38898	156
38899	156
38931	143
38936	143
38942	146
38943	146
38944	146
38945	146
38946	145
38947	145
38948	145
38949	145
39132	40
39188	137
39189	137
39192	137
39193	137
39196	137
39197	137
39199	137
39306	148
39307	148
39308	148
39309	148
39314	142
39315	142
39316	142
39317	142
39318	142
39319	142
39397	151
39606	147
39607	147
39608	147
39609	147
39685	146
39686	146
39687	146
39698	147
39699	147
39743	149
39744	149
39755	150
39756	150
39757	150
39758	150
39767	141
39768	141

ITEM #	PAGE #
39769	141
39770	141
39771	141
39772	141
39773	145
39774	145
39775	145
39776	145
39781	149
39804	147
39805	147
39806	147
39862	155
39864	155
39865	156
39909	153
39930	153
39932	141
39933	141
39934	141
39935	141
39936	141
39937	141
40051	142
40052	142
40053	142
40055	142
50121	149
50122	149
50148	150
50149	150
50187	150
70300	142
70301	142
70302	142
70303	142
86815	103
86817	103
86819	103
86821	104
86823	104
86824	104
86840	103
86842	103
86844	103
86846	104
86848	104
86849	104
90649	160
90650	160
90651	160
90652	160
90655	161
90656	160
90660	162
90661	162

ITEM #	PAGE #
110105	124
110106	125
110107	125
110108	64
110109	64
110110	44
110111	44
110126	92
110127	96
110128	121
110138	121
110139	121
110142	122
110143	122
110144	122
110145	122
110147	97
110150	109
110155	67
110156	67
110157	67
110158	67
110194	106
110195	106
110196	106
110197	106
110198	56
110199	88
110200	92
110201	92
110202	92
110203	154
110204	154
110206	55
110207	55
110213	91
110214	91
110215	91
110221	58
110253	111
110265	154
110359	79
110359	80
110360	79
110375	65
110376	65
110382	129
110404	85
110405	85
110406	139
110407	108
110409	108
110411	45
110412	45
110413	46
110414	46

PRODUCT INDEX

ITEM #	PAGE #	ITEM #	PAGE #	ITEM #	PAGE #	ITEM #	PAGE #
110414	46	38862B	145	C555911-3	85	CPL5153C	84
110415	46	38863B	145	C5851	60	CPL5362A	71
110419	81	38864B	145	C5860	71	CPL5362C	71
110420	81	38942B	146	C5901L	60	CPL5531A	54
110443	65	38943B	146	C5901R	60	CPL5531C	54
11045	73	38944B	146	C5902	60	CPL5557A	84
110497	128	38945B	146	C606651	88	CPL5557C	84
110497	128	38946B	145	C677209	92	CPL5601C	57
110583	128	38947B	145	C7031RL	81	CPL5702A	58
110584	128	38948B	145	C7031RLBD	82	CPL5702C	58
110660	108	38949B	145	C7031RR	81	CPL5801A	60
110661	108	39314B	142	C7031RRBD	82	CPL5801C	60
110662	108	39315B	142	C7033RL	81	CPL6066A	83
110663	108	39316B	142	C7033RLBD	82	CPL6367A	72
110750	82	39317B	142	C7033RR	81	CPL6367C	72
110759	121	39318B	142	C7033RRBD	82	CPL6601LED	77
110760	121	39319B	142	C738703	94	CPL6701LED	77
110761	121	39483B	145	CBL5311	53	CPL6768A	95
110762	121	39484B	145	CBL5451LED	53	CPL6768C	95
110763	122	39485B	145	CBL5511LED	54	CPL6970AL	95
110764	122	39511B	137	CBL5607LED	57	CPL6970AR	95
110765	86	39512B	137	CBL6051	74	CPL6970CL	95
110766	85	39515B	137	CBL6111LED	74	CPL6970CR	95
110767	86	39644B	145	CBL6251LED	75	CPL7172A	95
110768	85	39645B	145	CBL6264LED	80	CPL7172C	95
110772	130	39684B	146	CBL6351LED	75	CTL3335LED-BL	43
110773	130	39685B	146	CBL6366LED	69	CTL3335LED-BR	43
110774	129	39686B	146	CBL6366LED	72	CTL3335LED-CL	43
110775	129	39687B	146	CBL6411LED	76	CTL3335LED-CR	43
110795	87	39773B	145	CBL6451LED	76	CTL3336LED-L	43
110796	111	39774B	145	CBL6551LED	77	CTL3336LED-R	43
110797	112	39775B	145	CBL6667LED	79	CTL3911LED	48
110798	114	39776B	145	CBL6704LED	64	CTL3918LED	48
110804	130	39994B	153	CBL6711LED	69	CTL4010LED	49
110805	130	39995B	154	CBL6712LED	69	CTL4010LED-AS	49
110837	129	90650A	160	CBL6851LED	78	CTL4053LED-L	44
110838	129	A1060-5	115	CBL6852LED	78	CTL4053LED-LBD	46
110843	94	A1060LED	110	CBL6853LED	65	CTL4053LED-R	44
110844	94	A5022BCL	21	CBL6951LED	69	CTL4053LED-RBD	46
110872	102	A5022SSE	21	CBL7101LED-L	68	CTL4053LL	44
110873	102	C3704RL	45	CBL7101LED-R	68	CTL424803	50
110890	101	C3704RLBD	47	CBL7201LED-L	68	CTL424804	50
110891	101	C3704RR	45	CBL7201LED-R	68	CTL424805	50
110892	101	C3704RRBD	47	CDL555701	58	CTL4248C	49
110893	101	C3910BL	47	CDL555701-AS	58	CTL4248LED	49
110894	101	C3910BR	47	CML6872A	96	CTL4248LEDBD	50
110895	101	C3910CL	47	CML6872R	96	CTL4901LED	51
34217B	41	C3910CR	47	CML7380A	96	CTL4950LED	143
36517B	144	C4009G	81	CML7380R	96	CTL4950LED-ALS	51
36518B	144	C4061CL	49	CPL3901AB	47	CTL4950LED-ARS	51
36519B	144	C4061RL	49	CPL3911A	48	CTL5152C	52
36520B	144	C4061RLBD	50	CPL4753A	82	CTL5152LED	52
36521B	144	C4062RR	49	CPL4753A-AC	82	CTL5152LED-AS	52
36621B	140	C4062RR	49	CPL4753A-AS	82	CTL5310	53
37499B	144	C4062RRBD	50	CPL4753C	82	CTL5312	53
37625B	143	C495004	51	CPL4753C-AC	82	CTL5401LED	53
38861B	145	C515301	84	CPL4753C-AS	82	CTL5408LED	54

PRODUCT INDEX

ITEM #	PAGE #	ITEM #	PAGE #	ITEM #	PAGE #	ITEM #	PAGE #
CTL5510LED	54	CTL6803LED	63	FTL2831BD-BAR	100	FTL383909	114
CTL5606A	52	CTL6804LED	69	FTL2831BD-L	100	FTL383910	114
CTL5606LED	52	CTL6805LED	63	FTL2831BD-MAL	102	FTL3839LED	111
CTL5606W	52	CTL6821LED-L	67	FTL2831BD-MAR	102	FTL3839NT-BD	113
CTL5608C	57	CTL6821LED-R	67	FTL2831BD-R	100	FTL3839NTLED	110
CTL5608LED	57	CTL6826LED	80	FTL2831LED-AL	99	FTL4004-2	116
CTL5701LED	71	CTL6853LED	63	FTL2831LED-AL	102	FTL4004LED	116
CTL5720LED	56	CTL6869LED-L	73	FTL2831LED-AR	99	FTL4004RB	116
CTL5859C	84	CTL6869LED-R	73	FTL2831LED-AR	102	FTL4005LED	116
CTL5859LED	84	CTL6901LED-L	63	FTL2831LED-BAL	100	FTL4006LED	117
CTL5860LED	71	CTL6901LED-R	63	FTL2831LED-BAR	100	F TL4011LED	117
CTL5860LED	72	CTL7072LED-L	73	FTL2831LED-L	99	FTL4014LED	116
CTL5901LED	59	CTL7072LED-R	73	FTL2831LED-R	99	FTL4101LED	117
CTL5902LED-L	60	CTL7073LED-L	65	FTL2831LED6-AL	99	FTL414103	117
CTL5902LED-R	60	CTL7073LED-R	65	FTL2831LED6-AR	99	FTL4248-1	119
CTL5903-1	59	CTL7101LED-L	68	FTL2831LED6-BAL	100	FTL424803	119
CTL5903R	59	CTL7101LED-R	68	FTL2831LED6-BAR	100	FTL424804	119
CTL5911LED	59	CTL7201LED-L	68	FTL2831LED6-L	99	FTL4248C	118
CTL5913LED	59	CTL7201LED-R	68	FTL2831LED6-R	99	FTL4248LED	118
CTL6061LED	74	CTL7387LED-L	93	FTL2831RA-AL	99	FTL4248R	119
CTL6066BC	86	CTL7387LED-R	93	FTL2831RA-AR	99	FTL4748A	120
CTL6066BR	86	CTL7582LED	70	FTL2831RA-BAL	100	FTL4748C	120
CTL6066C	86	CTL8010C	70	FTL2831RA-BAR	100	FTL4950LED	120
CTL6066FC	88	CTL8010LED	70	FTL2831RA-L	99	FTL4950LED-AS	120
CTL6066FSC	87	CTL8490LED	70	FTL2831RA-R	99	FTL5356LLB	130
CTL6066FSLED	88	CTL9096LED	70	FTL2831RA6-AL	99	FTL6106LED	126
CTL6066FSLED	88	DTL6801LED	132	FTL2831RA6-AR	99	FTL6401LED	124
CTL6066FSR	87	F3201LED	105	FTL2831RA6-BAL	100	FTL6406LED	126
CTL6066LED	86	F3301-LED	105	FTL2831RA6-BAR	100	FTL6411LED	124
CTL6066SC	86	F383901	111	FTL2831RA6-L	99	FTL6701LED	125
CTL6066SR	86	F383904	110	FTL2831RA6-R	99	FTL6772LED-L	128
CTL6111LED	74	F383904BD	113	FTL3201LED-AL	107	FTL6772LED-PR	128
CTL6201LED	75	F383905	112	FTL3201LED-AR	107	FTL6772LED-R	128
CTL6264LED	80	F42802	118	FTL3201LED-L	106	FTL6901LED	125
CTL6301LED	75	F42803	119	FTL3201LED-R	106	S1005	131
CTL6401LED	76	F42803C	119	FTL3336CB-L	109	S2005LED	12
CTL6402LED-L	66	F42805	119	FTL3336CB-R	109	S2007LED	154
CTL6402LED-R	66	F49501	120	FTL3336L	107	S2007LED-A	154
CTL6411LED	76	F49503	120	FTL3336L-BK	107	S2007LED-W	154
CTL6501C	77	F49504	120	FTL3336LED-AL	107	S2008LED	153
CTL6501LED	77	F6411	126	FTL3336LED-ALB	107	S2010LED	11
CTL6521LED-L	66	F6411-1	126	FTL3336LED-ARB	107	STL1001LED	131
CTL6521LED-R	66	F6412	126	FTL3336LED-AR	107	STL1004LED	131
CTL6667LED	79	FPL2829LED	105	FTL3336LED-ARB	107	STL1006LED	131
CTL6701C	66	FPL3031LED	105	FTL3336LED-L	108	STL1010LED	132
CTL6701LED	66	FPL3232LED	105	FTL3336LED-R	108	STL1010LED-AS	132
CTL6703LED	63	FPL3334LED	105	FTL3336R	107	STL1012LED	131
CTL6704LED	64	FPL4001LED	115	FTL3336R-BK	107	VTL6870LED	132
CTL6721C	92	FPL4002LED	115	FTL3701LED-L	109		
CTL6721LED	92	FPL4101A	118	FTL3701LED-R	109		
CTL6721SEQ	91	FPL4111A	118	FTL3711L	109		
CTL6772LED	93	FPL6401LED	124	FTL3711R	109		
CTL6801C	78	FTL1156-PLUG	162	FTL3711RC	109		
CTL6801LED	78	FTL1157-PLUG	162	FTL383903	112		
CTL6802LED	78	FTL2831BD-AL	100	FTL383903ZR	113		
CTL6803C	64	FTL2831BD-AR	100	FTL383905ZR	112		
CTL6803LED	63	FTL2831BD-BAL	100	FTL383907	110		
				FTL383908	113		



United Pacific

1947-1987 CHEVY & GMC



As leaders in the industry, it is our mission to ensure the best fitment and function when it comes to your custom build. We understand the rigors and stresses that our products are subjected to on the road, so we partner with top manufacturing facilities that conform to our strict requirements and must perform quality assurance tests. It is our duty to provide our customers with products of superior quality and reliability.



QUALITY

With over 30 years of experience in the automotive aftermarket industry, United Pacific Industries understands the rigors and stresses that our products are subjected to on the road. It is our mission to provide our customers with products of superior quality and reliability. In achieving this goal, United Pacific only partners with manufacturing facilities that conforms to our quality control requirements and standards. Our manufacturing partners meet or exceed ISO-9001 requirements. In addition, United Pacific's manufacturing partners must be equipped on site to perform the following quality assurance tests and maintain a track record of consistent quality and low product failure rate.

- Aging Test
- Air Tight Test
- Dust Test
- Flux Test
- Photometric Test
- Pull Force Test
- Rain Test
- Salt Spray Test
- Shock Test
- Temperature Test
- Humidity Test
- Vibration Test

Furthermore, our internal quality control structure allows us to function as the final quality control station prior to shipping. With the assistance of 3D computer technology, United Pacific can adhere to strict quality control standards during prototype creation and the production process. Our engineers and technicians perform a battery of tests to ensure that our products meet the demands of today's drivers and our goal to be first in quality.

INNOVATION

Known as the leader in innovation, United Pacific is dedicated to be the first to bring new and exciting products to the market. United Pacific's global expertise allows us to search the globe for new ideas and concepts. Not only do we search the globe for new products, United Pacific invest a significant amount of resources into our own research and development efforts. With the assistance of advance 3D scanning technology, our engineers and designers can acquire accurate and precise data in seconds. The 3D data allows United Pacific to verify designs, perform quality assurance tests, and reverse engineer with unprecedented speed and accuracy. Digital inspection contributes to the early detection of shape problems, provides rapid feedback on design, and eliminates unnecessary work in downstream processes. Our rapid prototyping facility permits us to have a concept-to-shelf time of less than 5 months. In addition, United Pacific's 3D printing capabilities permit our designers to have physical models of their design concepts in hours. The physical models allow our designers and marketing staff to evaluate and test the viability of different design ideas. Our rapid prototyping facility allow United Pacific to compress design cycles, improve manufacturing planning, shorten concept-to-shelf time, most importantly, generate new and innovative products.

DESIGN

Located near some of the nation's most progressive automotive design centers, United Pacific established the UP Design Studio in 2002 to consolidate our position as the design leader in the automotive industry. UP Design Studio utilizes the latest generation of computer aided design (CAD) and studio/graphic software. The design studio is equipped with the newest computers and rapid prototyping systems. In addition, UP Design Studio is staffed by graduates from the nation's most prestigious design colleges. Unlike our competitors, United Pacific's design and manufacturing capabilities mean that we carry more new and original items than our competitors. The establishment of the design studio will enable us to generate even more new products with significant shorter concept-to-shelf time. The reduction in development cost mean that we can develop products utilizing design based development processes. Design based product development allows United Pacific to create new product concepts based on designs incorporating driver demands and needs instead of economic considerations. United Pacific's emphasis on design distinguishes and positions us ahead of our competitors.



WARRANTY

With LED (Light Emitting Diodes) rated at 100,000 hours of operation and solid-state construction, United Pacific's LED lights are extremely reliable and durable. Purchase with confidence, United Pacific offers a complete line of LED lighting products with extended or limited lifetime warranties. Please see the warranty policy page for more details.

INVENTORY AND SHIPPING

United Pacific carries over 20,000 items in our California distribution center. No other company in the heavy duty trucking industry can match United Pacific in the variety and range of in-stock inventories. With an order fill rate of over 98.5%, United Pacific is the largest and most reliable supplier in the industry. Our shipping department ships 96.8% of all orders within 24 hours and 98.9% within 48 hours. United Pacific's vast inventory and prompt shipping has made United Pacific the only source for our customer's chrome and lighting needs.



HARD AT WORK FOR THE ENVIRONMENT



United Pacific
132,000 sq ft
Distribution Center
Long Beach, CA

100% reduction in potable water used for landscaping
40% reduction in total energy use due to high-efficiency mechanical and lighting systems
82% of construction waste was diverted from landfills

LEED ACCOMPLISHMENTS

Sustainable Sites

- On-site bicycle storage, showers and changing areas for company employees.
- Preferred parking for low-emitting, fuel-efficient and carpool vehicles.
- Stormwater is infiltrated on-site and treated to remove contaminants to reduce environmental impact on local waterways.

Water Efficiency

- In addition to using reclaimed water, drought-tolerant plants and a high-efficiency irrigation system were installed to reduce the use of potable water for irrigation by 100%.

Energy and Atmosphere

- Efficient HVAC equipment and a lighting system with daylight controls reduces energy consumption by over 30%.
- Enhanced commission verifies that the building's energy and water-related systems are performing as intended by the initial design.

Indoor Environmental Quality

- Building ventilation systems was designed to provide enhanced levels of fresh outside air to building occupants.
- Interior finishes (plants, sealants, adhesives, coatings, carpet systems and composite wood) were selected with low levels of volatile organic compounds (VOCs) to reduce indoor air contamination.



TABLE OF CONTENTS

Week To Wicked	7-8	Glove Box / Hand Brake Covers / Pedals	95
Shortbed Body Panels	9-10	AC Vents / Defrost Ducts	96
Headlights	11-24	Vent Windows / Glass Channels	97-98
Headlight Bulbs / Adapters / Relay	25	Door Handles	99-100
LED Control Module	26	Window Regulators	101
Misc. Headlight Parts	27-28	Door Sill / Door Latch Relay	102
Headlight Visors	29-30	Door Latches / Striker Plates	103-104
Tail Lights	31-43	Running Boards / Bedside Steps	105-106
Tail Light Bezels	44	Gas Caps	107
Tail Light Housings / Brackets	45	Fuel Tanks	108
Tail Light Gasket / Backup Lights	46	Fuel Sending Units	109-110
Parking Lights	48-52	Hood Emblem	111
Parking Light Bezels / Gaskets	53-54	Hub Caps / Exhaust Deflector	112
Side Marker Lights	55-56	License Plate Frames	113-114
Misc. Lights	57-58	Horns / Compressor	115-116
License Light / Bracket w/ Light	59-60	Terms and Conditions	117-118
Bumpers	61-64	Warranty Policy / Returns	119-120
Grilles	65-66	Index	121-124
Hood Parts	67-68		
Battery Hold Downs / Trays Etc.	69-70		
Exterior Mirrors	71-78		
Wiper Blades / Arms	79-80		
Rear View Mirrors	81-84		
Gauge Packages	85-86		
Dash Knobs / Cables	87-88		
Switches / Shift knobs	89-90		
Steering Columns / Hub / Horn	91-92		
Steering Wheels	93-94		



**UNITED PACIFIC
WEEK TO WICKED 1971 CHEVY C10 BUILD**



In the most recent installment of Week to Wicked presented by Classic Trucks Magazine, United Pacific and the team over at the MotorTrend Tech Center in Santa Ana, California, banded together to transform a stock 1971 Chevy C10 Pick-up truck to a WICKED street performance ride...in just ONE WEEK! The build started off with the usual wrenches and sparks flying as the guys stripped the truck down in preparation for the complete restoration. Things motored along as we raced towards the final days updating the build with a new suspension, drivetrain, brakes, and steering components, a fresh set of wheels and tires, and some interior redecorating. As we finally reached the finish line, it was time to fire up the C10's ZZ6 small-block. The engine came to life on the first crank leaving the crew excited for the test drive and of course, the obligatory burnout.

THANKS TO ALL THAT HELPED WITH THE BUILD



United Pacific Industries:

Sheetmetal, Lighting, Restoration Products

Classic Performance Products:

Presenting (Steering, Dual Adjustable Coilover Suspension, 6 Piston Modular Brakes, EFI Fuel Tank)

Covercraft:

Official Car Cover

Dakota Digital:

Official Gauges (HDX Series)

Holley Performance:

Dual Quad Terminator EFI, Exhaust (Hooker Blackheart) & Radiator (Frostbite)

Strange Engineering:

Strange Bolt-In Housing for 67-72 c10, 3.70 Ratio, 31 Spline Axles

Gandrud Chevrolet:

Crate Engine- ZZ6 Chevy Small Block 405 horsepower and 406 lb.-ft. of torque

Old Air Products:

Air Conditioning- Hurricane Bolt in kit

American Legend:

Wheels- Racer series wheels 18x8 Front, 18X9 Rear

Gearstar Transmission:

200-4R Transmission

Custom Auto Sound Mfg:

Official Product (Bluetooth Audio System)

American Autowire:

Official Product (Classic Update Series Wiring Harness)

Odyssey Battery/Ha B&M Sports:

Official Product (Performance Series AGM Battery)

Procar by Scat:

Official Product (Seats)

Yank Performance:

Torque Converter

SHORTBED BODY PANELS

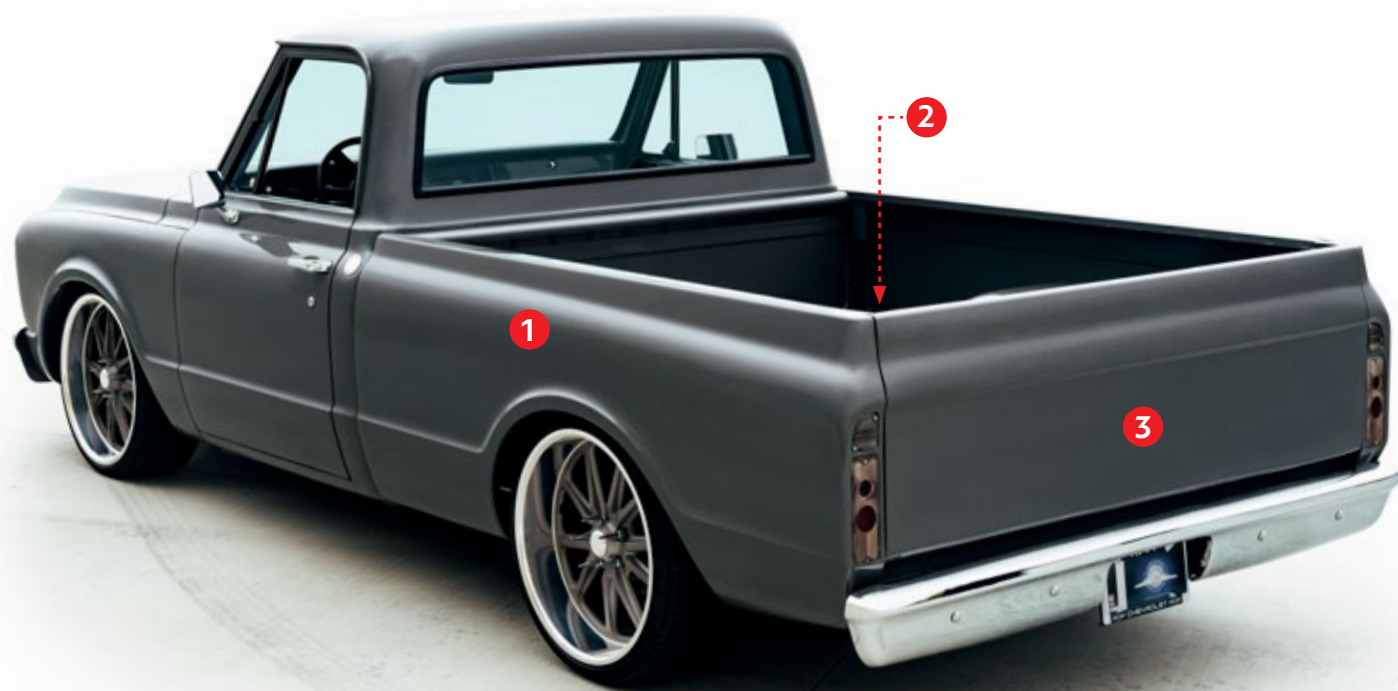

1



Bedside exterior



Bedside interior

1968-72 Chevy & GMC Fleetside Truck

SHORTBED BEDSIDE PANELS

- Reproduced exactly like the original with high quality 20-gauge steel, stamped with all the original contour and detail
- Complete bedside, includes installed and spot welded 17 gauge inner liner
- Features 3/8-16 and 5/16-18 threads welded in between exterior steel panel and inner reinforcement
- Black EDP Coated
- Includes rubber tailgate bumpers
- Has side marker cutout for 1968-72, but can be used on 1967 if side marker is desired
- Packed in heavy-duty cardboard box

110829 | LH/Driver | 1Pc. / Box

110830 | RH/Passenger | 1Pc. / Box

--- Pre-welded wheel well nuts



UNITED PACIFIC BODY PANELS

United Pacific is the source for quality body panels for long bed to short bed conversions. By reverse engineering each panel with exact specifications and modern technology, we are able to create a complete replica of short bed C10 bedside, bed floor pan and tailgate panels. Our high-quality heavy steel panels are manufactured with mounting holes and feature our exclusive welded nut inserts for the wheel well, tailgate pivot trunnion, tailgate support and striker.

United Pacific's goal is to ensure that our parts have the best possible fit and make sure installation is a breeze. We are here to help the C10 community restore and rebuild the truck of their dreams.

SHORTBED BODY PANELS

2

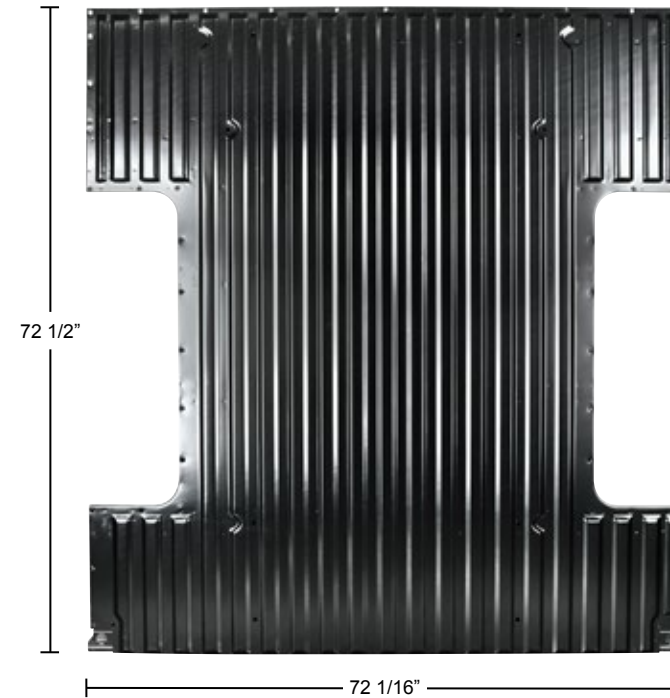

1967-72 Chevy & GMC Fleetside Shortbed Truck

6-1/2' BED FLOOR PAN

- 6-1/2' Bed Floor Pan For 1967-72 Chevy & GMC Truck Fleetside Shortbed
- Excellent stamped sheet metal reproduction with all of the original contour detail
- Quality 18 gauge floor panel with spot welded heavy 14 gauge crossmembers
- Features precision punched mounting holes for easy bed front, bed side, and wheel well installation
- Finished with black EDP protective coating

110839

3



1967-72 Chevy & GMC Fleetside Truck

TAILGATES

- Die stamped quality 17 gauge steel
- Precision cut latch handle pocket with mounting holes
- Two welded 5/16-18 nuts on each side for latch mounting
- Includes tailgate linkage posts and tailgate trunnion pockets
- Finish with black EDP protective coating to keep your new steel fresh and rust-free
- Official GM licensed for GMC lettering

110845 | Plain

110846 | Recessed Chevrolet Lettering

110847 | Recessed GMC Lettering

LED HEADLIGHTS



Universal

7" LED HEADLIGHT W/ POSITION LIGHT

- High power LED headlight with LED turn signal and position light bar
- Reinforced aluminum reflector with rugged anti-vibration construction
- Easy connection, fits OEM housing or fender, plugs into existing wiring harness, position light requires additional wiring
- DOT/SAE approved, sold individually

31458 | Amber LED Position Light Bar

31459 | White LED Position Light Bar



Universal

7" LED HEADLIGHT-BLACK

- 5 high power LED 7" headlight, Philips Lumileds
- Reinforced aluminum reflector with rugged anti-vibration construction
- Sold individually

31289



Universal

7" LED HEADLIGHT-CHROME

- 5 high power LED 7" headlight, Philips Lumileds
- Reinforced aluminum reflector with rugged anti-vibration construction
- DOT/SAE compliant, sold individually

31391

LED HEADLIGHTS



Universal

7" LED HEADLIGHT W/ POSITION LIGHT BAR

- High power LED headlight with 2 LED position light bar
- Dual function headlight with high and low beam
- Reinforced aluminum reflector with rugged anti-vibration construction
- Easy connection, fits OEM housing or fender, plugs into existing wiring harness, position light requires additional wiring
- DOT/SAE approved, sold individually

31200



Universal

7" LED HEADLIGHT W/ POSITION LIGHT BAR

- 3 high power LED headlight with 10 LED dual function position light bar
- 900 lumen output on low, 1,600 lumen output on high
- White position light bar can be wired as daytime running light and amber position light bar can be wired as turn signal
- Easy installation, fits OEM housing, plugs into existing wiring harness
- DOT/SAE approved, sold individually

31513 | White LED Position Light Bar

31514 | Amber LED Position Light Bar

LED HEADLIGHTS



LED HEADLIGHTS



Universal

7" LED CRYSTAL HEADLIGHT-CHROME

- 11 high power LED 7" headlight, impact resistant polycarbonate lens provides unparalleled protection from road hazards
- Die-cast aluminum housing provides maximum protection from the elements
- DOT/SAE compliant, sold individually

31355



Universal

7" LED PROJECTION HEADLIGHT W/ LED HALO

- 7" high power projection headlight with dual function LED halo ring
- Dual color white/amber auxiliary LED halo ring with amber automatic override feature
- Die-cast housing and polycarbonate lens provide maximum protection and durability
- Solid state design resists shock and vibration, IP67 weatherproof rating
- DOT/SAE compliant, sold individually

31496



Universal

7" LED HEADLIGHT

- 7" high power LED headlight
- Durable corrosion resistant polycarbonate lens & housing
- Solid state design resists shock and vibration, DOT/SAE headlight compliant
- Easy connection, fits OEM housing, plugs into existing wiring harness, position light requires additional wiring
- Low beam 500 lumens, high beam 950 lumens

31084

HEADLIGHTS W/ LED POSITION



Universal

7" CRYSTAL HEADLIGHT W/ LED HALO RING

- 7" crystal headlight with LED halo ring and 9007 bulb
- Reinforced aluminum reflector with rugged anti-vibration construction
- Sold individually

31284 | Amber LED Halo Ring

31285 | White LED Halo Ring



Universal

7" CRYSTAL HEADLIGHT W/ AUXILIARY LED

- High power LED 7" headlight with clear lens, 34 auxiliary LED
- Reinforced aluminum reflector with rugged anti-vibration construction
- H4/HB2/9003 halogen bulb: 12V 65/55W, replaces H6017/H6024
- HB2/9003 DOT/SAE code: DOT SAE-HR1-01
- DOT/SAE compliant, sold individually

31378 | Amber Auxiliary LED

31379 | White Auxiliary LED

Universal

7" CRYSTAL HEADLIGHT W/ LED POSITION LT

- 7" crystal headlight with 6 hi/low function amber LED position lights
- Reinforced aluminum reflector with rugged anti-vibration construction
- DOT/SAE Hr 15, LED for auxiliary/utility purposes, sold individually
- Includes 9007 halogen bulb and seal beam/H4 plug adapter
- 12V, dual function auxiliary LEDs have three wire hookup

31247



HEADLIGHTS



Universal

7" SEALED BEAM HEADLIGHT

- 7" regular 6014 sealed beam headlight
- Replaces H6014/H6024, high and low beam

30356



Universal

7" CRYSTAL HEADLIGHT

- Reinforced multi-surfaced, aluminum reflector
- Rugged anti-vibration construction
- Sylvania halogen bulb: H4/HB2 12V 65/55W
- Replaces H6014/H6024, SAE & ECE approved

31387



Universal

7" GLASS LENS HEADLIGHT

- 7" round headlight with glass lens & replaceable H4 bulb
- Replaces H6014/H6024, high and low beam, H4 bulb included

A5023-3



Universal

7" SEALED BEAM HEADLIGHT

- 7" regular 6014 sealed beam headlight
- Replaces H6014/H6024, high and low beam

30354



Universal

7" GLASS HEADLIGHT W/ 1893 Accent Socket

- 7" round glass headlight with 1893 accent socket
- High beam only

31393

LED HEADLIGHTS



Universal

5 3/4" LED HEADLIGHT W/ POSITION LIGHT

- 9 high power 5 3/4" LED headlight with LED position light bar
- High power bright LED high and low beam
- Reinforced aluminum reflector with rugged anti-vibration construction

31259 | Amber LED Position Light Bar

31267 | White LED Position Light Bar



Universal

5 3/4" LED HEADLIGHT

- 8 high power 5 3/4" LED headlight
- Replaces H5001 and H5006 bulb, DOT/SAE and FMVSS 108 compliant
- Easy connection, fits OEM housing or fender, plugs into existing wiring harness
- Low beam 1,020 lumens, high beam 1,600 lumens

31201 | Silver

31202 | Black



Universal

5 3/4" CRYSTAL HEADLIGHT

- Beautiful crystal clear front lens
- Reinforced multi-surfaced, aluminum reflector, rugged anti-vibration construction
- Sylvania halogen bulb: SAE 9007 12V 65/55W
- Replaces H5001/H5006, SAE & ECE approved
- 9007 bulb adapter plug included, item # 34207V

31386

Universal

5 3/4" SEALED BEAM HEADLIGHT

- 5 3/4" round sealed beam Philips headlight
- High beam and low beam

H5006

LED HEADLIGHTS



Universal

5"x7" LED HEADLIGHT

- 9 high power LED rectangular headlight with 6 white LED light bar
- Reinforced aluminum reflector, rugged anti-vibration construction
- IP67 weatherproof rating
- High beam 3,700 lumens, low beam 1,800 lumens

34122



Universal

5"x7" LED HEADLIGHT

- 12 High power LED rectangular headlight with durable corrosion resistant polycarbonate lens & housing
- Solid state design resists shock and vibration
- Easy connection, fits OEM housing, plugs into existing wiring harness, position light requires additional wiring
- High beam 1,100 lumens, low beam 600 lumens

31087



Universal

5"x7" LED CRYSTAL HEADLIGHT

- 5 high power LED crystal headlight with high and low beam function
- Reinforced aluminum reflector and rugged anti-vibration construction

31297

LED HEADLIGHTS



Universal

4"x6" LED HEADLIGHT W/ AMBER AUXILIARY

- High power LED headlight with quality crystal clear polycarbonate lens
- Center light bar with 9 super bright amber LEDs
- Waterproof die-cast housing provides maximum protection and durability
- OEM fit, plugs into existing wiring harness
- Sold individually, please specify low beam or high beam

31150 | Low Beam

31151 | High Beam



Universal

4"x6" LED HEADLIGHT W/ WHITE AUXILIARY

- High power LED headlight with quality crystal clear polycarbonate lens
- Center light bar with 9 super bright white LEDs
- Waterproof die-cast housing provides maximum protection and durability
- OEM fit, plugs into existing wiring harness
- Sold individually, please specify low beam or high beam

31152 | Low Beam

31153 | High Beam



Universal

4"x6" LED CRYSTAL HEADLIGHT

- High power 5 LED rectangular crystal headlight with high and low beam function
- Reinforced aluminum reflector, rugged anti-vibration construction
- Replaces H4651/H4656
- SAE approved

31365

LED HEADLIGHTS



Universal

4"x6" LED HEADLIGHT-HIGH BEAM

- Durable corrosion resistant polycarbonate lens & housing
- Solid state design resists shock and vibration
- Easy connection, fits OEM housing, plugs into existing wiring harness, position light requires additional wiring
- High beam 1000 lumens, 6500kelvin, 12-24v DC input

31089



Universal

4"x6" LED HEADLIGHT-LOW BEAM

- Durable corrosion resistant polycarbonate lens & housing
- Solid state design resists shock and vibration
- Easy connection, fits OEM housing, plugs into existing wiring harness, position light requires additional wiring
- Low beam 750 lumens, 6500kelvin, 12-24v DC input

31088



Universal

4"x6" BLACKOUT LED HEADLIGHT-HIGH BEAM

- 4"x6" rectangular crystal headlight with 1 high power LED and 6 high power LED position lights
- Solid state design resists shock and vibration
- Durable corrosion resistant polycarbonate lens & housing
- Load resistor may be required for proper installation
- DOT/SAE FMVSS 108

31299

LED HEADLIGHTS



Universal

4"x6" LED HEADLIGHT W/ POSITION LIGHT

- Rectangular 1 high power LED headlight with 6 amber LED dual function position lights
- Solid state design resists shock and vibration
- Die-cast aluminum housing, impact resistant polycarbonate lens for protection from road hazards
- 12-24v DC input, -.35 Amps / 8.5 Watt, FMVSS 108
- Sold individually, please specify low beam or high beam

31237 | Low Beam
31238 | High Beam



Universal

4"x6" LED PROJECTION HEADLIGHT

- 11 high power LED projection headlight with white LED position light bar
- Die-cast aluminum housing, impact resistant polycarbonate lens for protection from road hazards
- Solid state design resists shock and vibration, DOT/SAE FMVSS 108

31274 | Low Beam
31275 | High Beam



Universal

4"x6" LED HEADLIGHT W/ POSITION LIGHT

- Rectangular 1 high power LED headlight with 6 white LED dual function position lights
- Solid state design resists shock and vibration, DOT/SAE headlight compliant
- Die-cast aluminum housing, impact resistant polycarbonate lens for protection from road hazards
- Low beam 600 lumens, high beam 1,000 lumens
- Sold individually, please specify low beam or high beam

31168 | Low Beam
31169 | High Beam



Universal

4"x6" LED HEADLIGHT W/ LED LIGHT BAR

- 9 high power LED dual function light with 6 white LED light bar
- Reinforced aluminum reflector, rugged anti-vibration construction
- Headlight fits OEM housing, plugs into existing wiring harness
- For off-road use only

34125



Universal

4"x6" CRYSTAL PROJECTION HEADLIGHT

- Crystal projection headlight with 6 white LED position lights
- Reinforced aluminum reflector, rugged anti-vibration construction
- Low beam includes two 9005 adapter plugs (one 3 wire to 2 wire plug and one 2 wire plug)
- High beam has 2 wires and 9005 adapter plug
- Sold individually, please specify low beam or high beam

31375 | Low Beam
31376 | High Beam



Universal

4"x6" CREE LED HEADLIGHT

- 1 high power Cree LED headlight
- Solid state design resists shock and vibration, DOT/SAE FMVSS 108
- Improves visibility with whiter light output that is closer to daylight
- Durable corrosion resistant polycarbonate lens & housing
- Load resistor may be required for proper installation, SAE/DOT FMVSS108
- Sold individually, please specify low beam or high beam

31396 | Low Beam
31397 | High Beam

HEADLIGHTS W/ LED POSITION



Universal

4"x6" LED CRYSTAL HEADLIGHT

- Crystal headlight with 9 amber LED position lights
- Reinforced aluminum reflector
- Rugged anti-vibration construction
- Sold individually, please specify low beam or high beam

31373 | Low Beam

31374 | High Beam



Universal

4"x6" CRYSTAL HL W/ LED POSITION LIGHT

- Crystal headlight with 9 white LED position lights
- Reinforced aluminum reflector
- Rugged anti-vibration construction
- Sold individually, please specify low beam or high beam

31368 | Low Beam

31369 | High Beam

HEADLIGHTS



Universal

4"x6" RECTANGULAR CRYSTAL HEADLIGHT

- Reinforced aluminum reflector, rugged anti-vibration construction
- Replaceable bulb, Sylvania halogen bulb: SEA-9007 12V 65/55W
- Replaces H4651/H4556, SAE & ECE approved
- High and low beam, 9007 bulb adapter plug included

31388



Universal

4"x6" RECTANGULAR CRYSTAL HEADLIGHT

- Reinforced aluminum reflector, rugged anti-vibration construction
- Replaceable bulb, Sylvania halogen bulb: SEA-9007 12V 65/55W
- Replaces H4651/H4556, SAE & ECE approved
- High beam only, 2 wire 9007 bulb adapter plug included

31390



Universal

5"x7" RECTANGULAR CRYSTAL HEADLIGHT

- Reinforced aluminum reflector, rugged anti-vibration construction
- Replaceable bulb, Sylvania halogen bulb: H4/HB2, 12V 65/55W
- Replaces H6054

31389

BULBS / ADAPTERS / ETC.



Universal

9005/HB3 LED HEADLAMP BULB

- 2 Cree high power white LED headlamp bulb
- 10W low beam application, bright 1,200 lumen output, 6,000k
- Fan-less design, proprietary heat sink dissipates excess heat
- Sold individually

36888

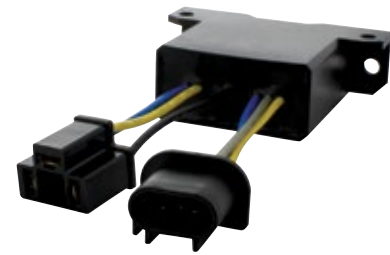

Universal

LED HL ANTI FLICKER MODULE & ADAPTER

- LED headlight PWM anti flicker module & adapter for most vehicles using pulse width modulated electrical systems
- Eliminates flicker on LED headlamps
- Adapts common H13 plug to H4 plug used by most LED headlights

34217B

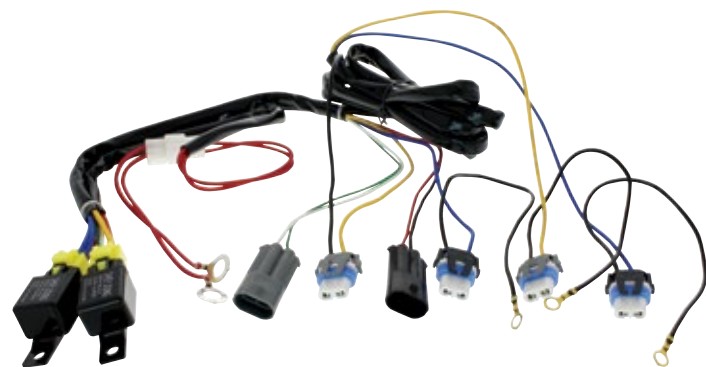

Universal

9005/9006 HEADLIGHT RELAY HARNESS KIT

- Sends high amperage to headlamps and corrects dim lights
- 12 volt

34264



Universal

XENON WHITE 9007 HALOGEN BULB

- 12V, Hi/Low function
- High beam 100 watt/low beam 80 watt
- Sold in pairs

39132

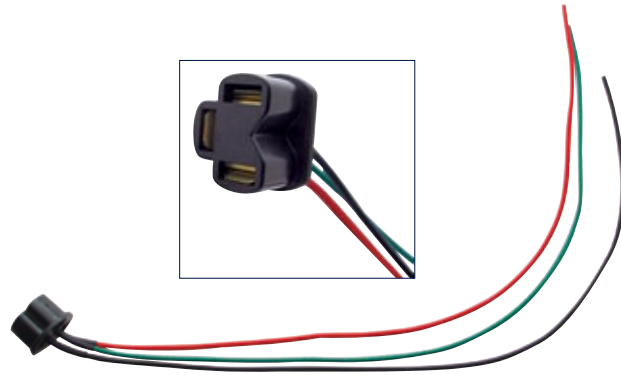

Universal

HEADLIGHT PIGTAIL

- 3 contact female pigtail for H4 halogen bulbs
- Head resistant wire, OEM #: 01A-13076
- Sealed beam or halogen bulb socket with 3 high heat resistant nylon wires, black, green and red

34222

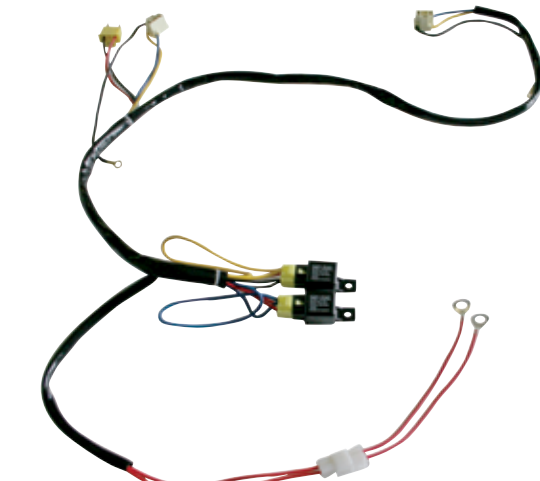

Universal

H4 HEADLIGHT RELAY HARNESS KIT

- Sends high amperage to headlamps and corrects dim lights
- Works on original style 6014 sealed beams

34263

LED CONTROL MODULE

Universal

DUAL FUNCTION LED CONTROL MODULE

- Add dual function high/low brightness to 31378 and 31379 headlamps with 34 LED accent lights
- Built in split operation for motorcycle application
- Easy plug & play hookup, wiring instructions included
- Sold individually, for 12 Volt LED use only

31372

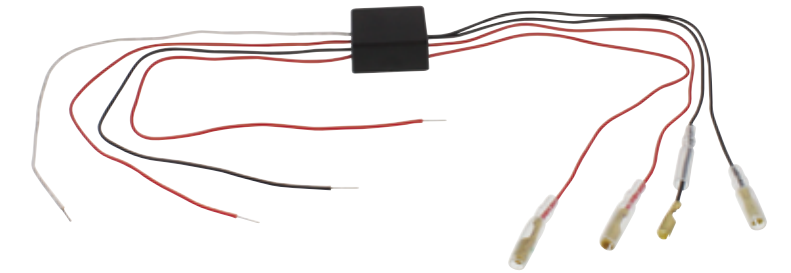

For Cars & Trucks

- Red wires 12+ for turn signal (high brightness). Connect BOTH red wires together.
- Black wire 12+ for parking/running light (lower brightness).
- White wire negative (ground-).

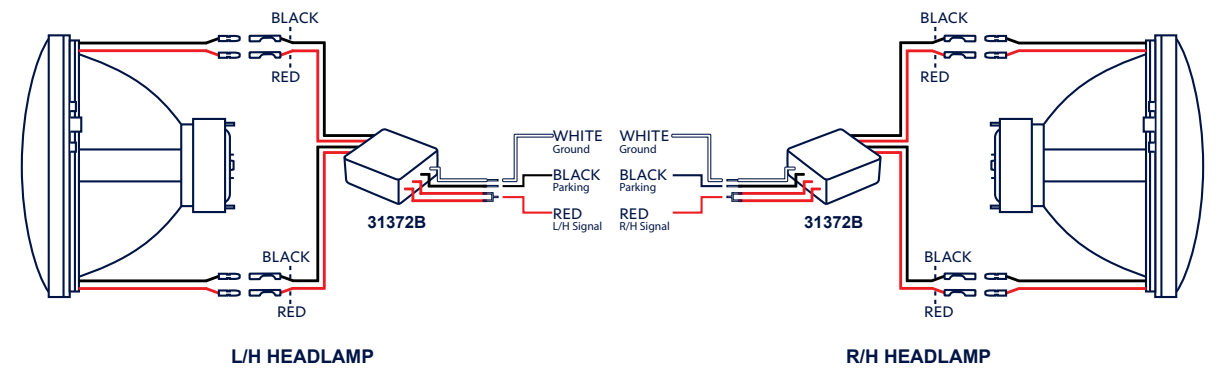

For Motorcycles

- Red wires 12+ for R/H and L/H turn signal (high brightness).
- Black wire 12+ for parking/running light (lower brightness).
- White wire negative (ground-).

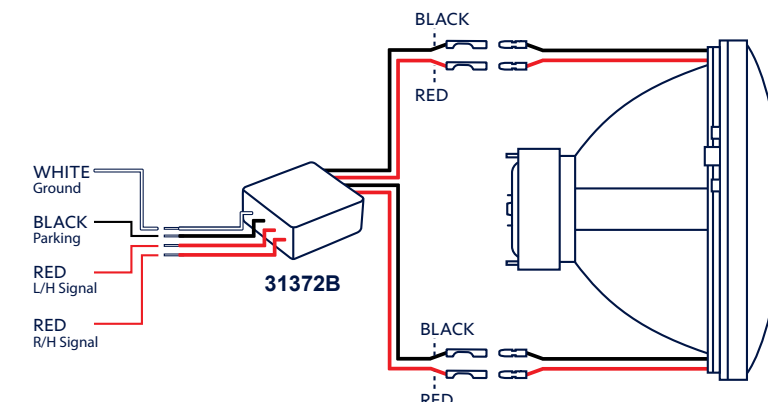

HEADLIGHT PARTS



1947-54 Chevy Truck

HEADLIGHT RIM KIT

- Includes 2 polished stainless steel headlight bezels, 2 rubber "o" ring gaskets, 2 set clips
- Headlight bezels, "o" rings, and clip set also available separately

C7011-KIT

C7011 | Headlight Bezel Only

C7012 | Bezel "O" Ring Only

C7013 | Headlight Clip Set Only



1963 Chevrolet Truck

CHROME HEADLIGHT BEZEL

- Beautiful triple chrome plating
- 8 oval head sheet metal screws included
- Sold in pairs

110429



1955-57 Chevy Truck

CHROME HEADLAMP BEZEL SET

- Beautiful chrome plating
- High quality rubber seals included
- Sold as a set

110705



1958-59 Chevy Truck

CHROME HEADLIGHT BEZEL

- Sold in pairs

C585981

HEADLIGHT PARTS

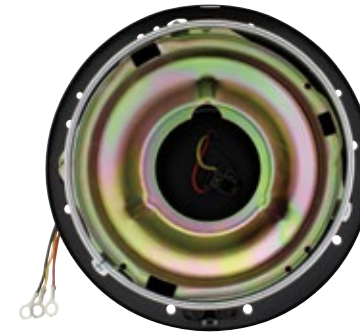

1947-54 Chevy & GMC Truck

HEADLIGHT BUCKET

- Steel reproduction like original
- Includes inner headlamp cradle, aiming adjusters, springs, chrome headlamp retainer ring and screws
- Headlamp wiring pigtail with ring terminals like original
- Fits LH/Driver and RH/Passenger

110282



1955-57 Chevy & GMC Truck

HEADLIGHT BUCKET

- Steel reproduction like original
- Includes headlamp bulb retaining ring and electrical pigtail
- Fits LH/Driver and RH/Passenger

110283



1967-72 GMC Truck

HEADLIGHT MOUNTING BUCKET SET

- High quality 19 gauge sheet metal stamped buckets, 8 piece set
- Each bucket is properly trimmed with grooves for specific bulbs
- Chrome plated headlamp retainer rings
- 6-32 screws included for mounting retainer ring to bucket

110358

HEADLIGHT VISORS



Universal

7" ROUND HEADLIGHT DROP VISOR

- Sold individually
- 10532 | Stainless Steel



Universal

7" ROUND HEADLIGHT VISOR

- Sold individually
- 10468 | Stainless Steel
- 10467 | Chrome



Universal

CHROME HALF MOON HEADLIGHT SHIELDS

- Stick out style headlight visor
- Fits 5 3/4" headlights or dual round headlight systems
- Sold in pairs
- 10476 | 7 1/2" | Chrome | Fits 6014, 6015, 6016
- 10477 | 5 3/4" | Chrome | Fits 4000, 4001, 4040, 5001
- 21476 | 7 1/2" | Stainless Steel | Fits 6014, 6015, 6016
- 21477 | 5 3/4" | Stainless Steel | Fits 4000, 4001, 4040, 5001



Universal

HEADLIGHT VISORS WITH GLASS DOTS

- 7 1/2" round headlight visor
- Sold individually
- 10444 | Blue Dot | Chrome
- 10445 | Blue Dot | Stainless Steel
- 10448 | Red Dot | Chrome
- 10449 | Red Dot | Stainless Steel



Universal

OUTSIDE MOUNTING HEADLIGHT VISORS

- Stainless steel
- Fits 7 1/2" headlights
- Sold in pairs
- C5010



Universal

TRANSPARENT PLASTIC VISORS

- 7 1/2" headlight visor
- Sold in pairs
- C2001A | Amber
- C2001B | Blue
- C2001G | Green
- C2001R | Red



Universal

OUTSIDE MOUNTING HEADLIGHT VISORS

- Stainless steel
- Fits 7 1/2" headlights
- Sold in pairs
- C5006



Universal

CHROME CATS EYE HEADLIGHT COVERS

- Also fits Volkswagen 67-68 Beetle, 67-73 Type LII, 68/69 Bus, 74-77 Dasher, and 75-79 Rabbit
- Sold in pairs
- 10466 | 7" Headlights
- 10461 | 5 3/4" Headlights



LED TAIL LIGHTS



LED TAIL LIGHTS



1940-53 Chevy Truck

23 LED TAIL LIGHT ASSEMBLY W/ BLUE DOT

- 23 super bright red LEDs, with LED blue dot, 6 super white LEDs for license light, polycarbonate lens
- Blue dot can be controlled independently with additional wiring
- Sold individually please specify LH/Driver or RH/Passenger

C7031RLBD | Black Housing | LH/Driver

C7031RRBD | Black Housing | RH/Passenger

C7033RLBD | Stainless Housing | LH/Driver

C7033RRBD | Stainless Housing | RH/Passenger

1940-53 Chevy & GMC Truck

27 LED SEQUENTIAL TAIL LIGHT ASSEMBLY

- 27 super bright red LEDs, 6 super white LEDs for license light
- Features sequential operation with selector switch to select sequential left, sequential right, or sequential function off
- Features sequential once brake attention function
- LH/Driver side includes 6 super bright white LED license light
- Recommended to upgrade with LED flasher 90652
- Sold individually please specify LH/Driver or RH/Passenger

110415 | Black Housing | LH/Driver

110416 | Black Housing | RH/Passenger

110419 | Stainless Housing | LH/Driver

110420 | Stainless Housing | RH/Passenger

«« SEQUENTIAL »»
(((BRAKE ATTENTION)))

LED TAIL LIGHTS



C7031RL C7033RL C7001L C7028L-1

1940-53 Chevy & GMC Truck

45 LED TAIL LIGHT ASSEMBLY

- 45 super bright LED tail light, 6 super bright white LED license light
- Recommended to upgrade with LED flasher 90652 (2-Terminal) Or 90651 (3-Terminal)
- Sold individually please specify LH/Driver or RH/Passenger

- C7031RL | Black Housing | LH/Driver
 C7031RR | Black Housing | RH/Passenger
 C7033RL | Stainless Housing | LH/Driver
 C7033RR | Stainless Housing | RH/Passenger

1940-53 Chevy & GMC Truck

TAIL LIGHT ASSEMBLY W/ RED GLASS LENS

- High quality chrome plated bezel with black or chrome housing
- Sold individually please specify LH/Driver or RH/Passenger

- C7001L | Black Housing | LH/Driver
 C7001R | Black Housing | RH/Passenger
 C7001L-1 | Black / Blue Dot | LH/Driver
 C7001R-1 | Black / Blue Dot | RH/Passenger
 C7002R | Stainless Housing | RH/Passenger
 C7028L | Stainless Housing | LH/Driver
 C7028R | Stainless Housing | RH/Passenger
 C7028L-1 | Stainless / Blue Dot | LH/Driver
 C7028R-1 | Stainless / Blue Dot | RH/Passenger



1940-53 Chevy & GMC Truck

27 LED SEQUENTIAL TAIL LIGHT LENS

- 27 super bright red LEDs, 6 super white LEDs for license light
- Features sequential operation with selector switch to select sequential left, sequential right, or sequential function off
- Features sequential once brake attention function
- LH/Driver includes LED license illuminator lens with 6 super bright white LEDs
- Recommended to upgrade with LED flasher 90652
- Sold individually please specify LH/Driver or RH/Passenger

- 110110 | LH/Driver
 110111 | RH/Passenger

SEQUENTIAL
F.L.A.S.H.

(((BRAKE ATTENTION)))



LED TAIL LIGHTS



1940-53 Chevy & GMC Truck/ 1937-38 Chevy Car



1940-53 Chevy & GMC Truck/ 1937-38 Chevy Car

23 LED TAIL LIGHT W/ BLUE DOT

- 23 LED tail light w/ LED blue dot, with polycarbonate lens
- Dual function with tail light and bright stop/turn signal
- Left hand includes 6 super white LED license plate lights
- Epoxy coated, fully sealed electronics
- Energy efficient solid-state circuit board engineered for 7.7-14.0 VDC systems
- Recommended to upgrade with LED flasher 90652

- CTL4053LED-LBD | LH/Driver
 CTL4053LED-RBD | RH/Passenger



1940-53 Chevy & GMC Truck/ 1937-38 Chevy Car



1940-53 Chevy & GMC Truck/ 1937-38 Chevy Car

23 LED TAIL LIGHT W/ BLUE DOT SET

- 23 LED tail light w/ LED blue dot, with polycarbonate lens
- Dual function with tail light and bright stop/turn signal
- Left hand includes 6 super white LED license plate light
- Epoxy coated, fully sealed electronics
- Energy efficient solid-state circuit board engineered for 7.7-14.0 VDC systems
- Recommended to upgrade with LED flasher 90652
- Set includes: CTL4053LED-LBD & CTL4053LED-RBD

110750



1940-53 Truck / 1937-38 Chevy Passenger Car

27 LED TAIL LIGHT LENS

- 27 super bright red LEDs for tail light and 6 white LEDs for license plate light
- Epoxy coated, fully sealed electronics
- Solid state circuit boards are designed for 7.7-14.0 VDC

- CTL4053LED-L | LH/Driver
 CTL4053LED-R | RH/Passenger



1940-53 Chevy & GMC Truck

RED GLASS TAIL LIGHT LENS

- Beautiful red glass lens
- Identical shape and size as the original
- Sold individually

- C4009 | Red Lens
 C4009-1 | Red Lens w/ Blue Dot

LED TAIL LIGHTS



1954-59 Chevy & GMC Truck

LED SEQUENTIAL TAIL LIGHT ASSEMBLY

- Super bright red LED light with housing
- Features sequential operation with selector switch to select sequential left, sequential right, or sequential function off
- Features sequential once brake attention function
- Requires use of United Pacific LED turn signal flasher, item number: 90652 or 90649
- DOT & SAE approved

110767 | Black Housing

110768 | Chrome Housing



1954-59 Chevy & GMC Truck

29 LED TAIL LIGHT ASSEMBLY

- 29 super bright red LED light with housing
- Epoxy coated, fully sealed electronics
- 1157 double connector with off set pins, plugs into existing tail lamp socket
- Requires use of United Pacific LED turn signal flasher, item number: 90652 or 90649
- DOT & SAE approved

110765 | Black Housing

110766 | Chrome Housing

1954-59 Chevy Truck

41 LED TAIL LIGHT ASSEMBLY

- 41 super bright red LED light with polycarbonate lens
- Epoxy coated, fully sealed electronics, 1157 plug
- Recommended upgrade with LED flasher No. 90652 (2-terminal) or 90651 (3-terminal)

CTL5459BR | Black Housing | Red Lens

CTL5459BC | Black Housing | Clear Lens

CTL5459SR | Stainless Steel Housing | Red Lens

CTL5459SC | Stainless Steel Housing | Clear Lens

TAIL LIGHTS



1960-66 Chevy Stepside Truck

41 LED TAIL LIGHT ASSEMBLY

- 41 super bright red LED light with polycarbonate lens
- Epoxy coated, fully sealed electronics

CTL6066BR | Black Housing | Red Lens

CTL6066BC | Black Housing | Clear Lens

CTL6066SR | Stainless Steel Housing | Red Lens

CTL6066SC | Stainless Steel Housing | Clear Lens



1954-55 Chevy 1st Series Truck

TAIL LIGHT ASSEMBLY

- Injection molded high quality polycarbonate plastic with chrome plated bezel
- Sold individually

C545505 | W/O Blue Dot

C545507 | W/ Blue Dot

1954-55 Chevy Truck

TAIL LIGHT ASSEMBLY

- Injection molded high quality polycarbonate plastic with chrome plated bezel
- Sold individually

C545504BK | Black Housing

C545504SS | Stainless Housing



1955-59 Chevy Truck

TAIL LIGHT ASSEMBLY

- Injection molded high quality polycarbonate plastic
- Sold individually

C555910 | Black Housing

C555911 | Stainless Housing

1960-66 Chevy Stepside Truck

TAIL LIGHT ASSEMBLY

- Injection molded high quality polycarbonate plastic
- Sold individually

C606607 | Black Housing

C606608 | Stainless Steel Housing

LED TAIL LIGHTS



1955-59 Chevy Stepside Truck

TAIL LIGHT LENS

- Injection molded from high quality polycarbonate plastic
- Sold individually

C555908 | Red Lens

C555912 | Red lens w/ Blue Dot



1958-59 Chevy Fleetside Truck

TAIL LIGHT LENS

- Injection molded from high quality polycarbonate plastic
- Sold individually

C585901 | Red Lens

C585902 | Red Lens w/ Blue Dot

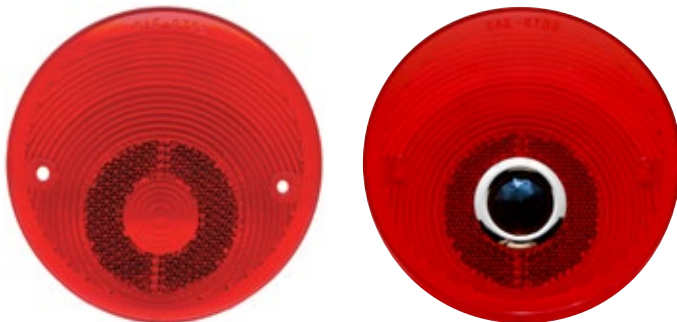

1960-66 Chevy Stepside Truck

TAIL LIGHT LENS

- Injection molded from high quality polycarbonate plastic
- Sold individually

C606605 | Red Lens

C606610 | Red Lens w/ Blue Dot



1954-59 Chevy Truck

41 LED TAIL LIGHT

- 41 super bright red LEDs
- Epoxy coated, fully sealed electronics
- Solid state circuit boards are designed for 7.7-14.0 VDC

CTL5459LED | Red Lens

CTL5459C | Clear Lens



1958-59 Chevy Truck

41 LED TAIL LIGHT

- 41 super bright red LEDs
- Epoxy coated, fully sealed electronics
- Solid state circuit boards are designed for 7.7-14.0 VDC

CTL5859LED | Red Lens

CTL5859C | Clear Lens



1960-66 Chevy Truck

41 LED TAIL LIGHT

- 41 super bright red LEDs
- Epoxy coated, fully sealed electronics
- Solid state circuit boards are designed for 7.7-14.0 VDC

CTL6066LED | Red Lens

CTL6066C | Clear Lens

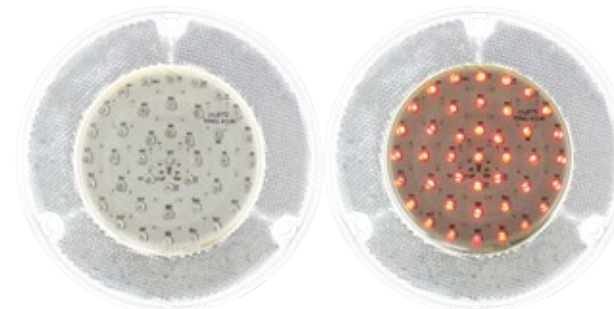

1967-72 Chevy Stepside Truck

41 LED TAIL LIGHT

- 41 Super bright red LEDs with clear lens
- Polycarbonate lens, epoxy coated, fully sealed electronics
- 1157 plug
- Energy efficient solid state circuit board engineered for 7.7-14.0 VDC systems
- Recommended under dash flasher is item no. 90652 (2-Terminal) or 90651 (3-terminal)
- Sold individually

CTL6722CL

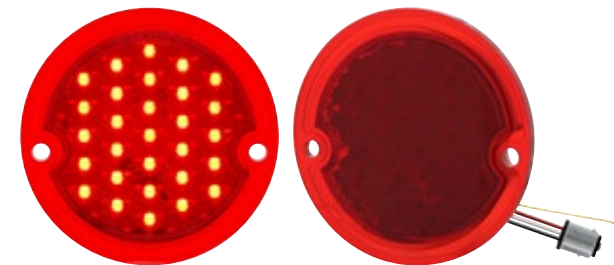

1954-59 Chevy & GMC 2nd Series Stepside Truck

29 LED TAIL LIGHT

- 29 LED red tail light
- Sold individually

110404



1955-58 Chevy Cameo Truck

TAIL LIGHT LENS

- Injection molded from high quality polycarbonate plastic
- Sold individually

C7006 | Red Lens

C7006-1 | Red Lens w/ Blue Dot

LED TAIL LIGHTS

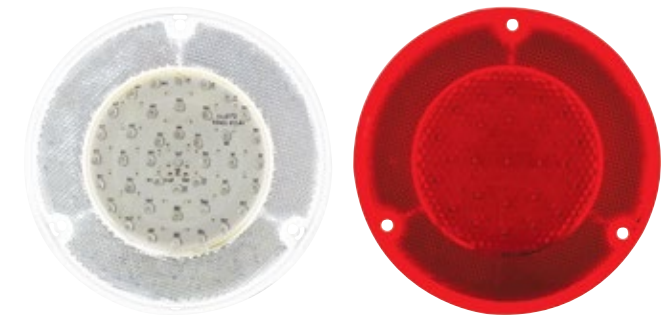

1967-72 Chevy Truck

41 LED TAIL LIGHT

- 41 super bright red LEDs
- Epoxy coated, fully sealed electronics
- Solid state circuit boards are designed for 7.7-14.0 VDC

CTL6772LED | Red Lens

CTL6772C | Clear Lens

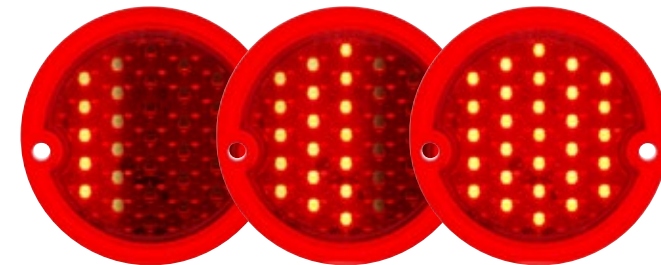

1954-59 Chevy & GMC 2nd Series Stepside Truck

29 LED SEQUENTIAL TAIL LIGHT

- 29 LED sequential tail light
- Sold individually

110405



1956-59 Chevy & GMC Panel Truck

TAIL LIGHT LENS

- Injection molded from high quality polycarbonate plastic
- Sold individually

C7008 | Red Lens

C7008-1 | Red Lens w/ Blue Dot

LED TAIL LIGHTS

1960-66 Chevy & GMC Fleetside Truck

TAIL LIGHT ASSEMBLY

- Includes housing, lens, gasket, socket, 1157 bulb & wiring
- Sold individually

C606616 | Original Lens
 C606616BD | Red Lens w/ Blue Dot
 C606616C | Clear Lens w/ Red Bulb



1960-66 Chevy Fleetside Truck

LED TAIL LIGHT ASSEMBLY

- Complete with housing, lens gasket, socket & wiring
- Sold individually please specify LH/Driver or RH/Passenger

CTL6066FSR | Red Lens
 CTL6066FSC | Clear Lens/Red LED



1960-66 Chevy & GMC Fleetside Truck

40 LED SEQUENTIAL TAIL LIGHT

- 40 super bright red LED with fully sealed epoxy coated electronics
- Features sequential operation with selector switch to select sequential left, sequential right, or sequential function off
- Features sequential once brake attention function
- Complete with zinc plated housing, lens, gasket, socket & wiring
- OE style wiring with bullet terminal connectors
- Requires use of United Pacific LED turn signal flasher, item number: 90652 or 90649
- SAE/DOT FMVSS108

110795

LED TAIL LIGHTS



1960-66 Chevy & GMC Fleetside Truck

40 LED SEQUENTIAL TAIL LIGHT

- 40 super bright red LED with fully sealed epoxy coated electronics
- Available with standard LED or sequential operation with selector switch to select sequential left, sequential right, or sequential function off
- Complete with polycarbonate lens and LEDs sealed inside
- Easy electrical connection with 1157 plug, 12 volt only
- Recommended Under Dash Flasher Is Item No. 90652 (2-Terminal) Or 90651 (3-Terminal)

110199



1960-66 Chevy Truck

40 LED TAIL LIGHT

- 40 super bright red LEDs, epoxy coated, fully sealed electronics
- Solid state circuit boards are designed for 7.7-14.0 VDC

CTL6066FSLED | Red Lens
 CTL6066FC | Clear Lens



1960-66 Chevy & GMC Fleetside Truck

TAIL LIGHT LENS

- Injection molded from high quality polycarbonate plastic
- Sold individually

C606617 | Red Lens
 C606618 | Red Lens w/ Blue Dot



1960-66 Chevy & GMC Fleetside Truck

TAIL LIGHT LENSES AND BULBS

- Injection molded from high quality polycarbonate plastic
- Fits LH/Driver and RH/Passenger
- Use 39014 clear with red lenses, 39006 red bulb with clear lenses

C606609 | Red Lens
 C606611 | Red Lens w/ Blue Dot
 C60609C | Clear Lens
 39014 | Clear 1157 Bulb 2 Pack
 39006 | Red 1157 Bulb 10 Pack
 C606603 | Aluminum Bezel



LED TAIL LIGHT ASSEMBLIES

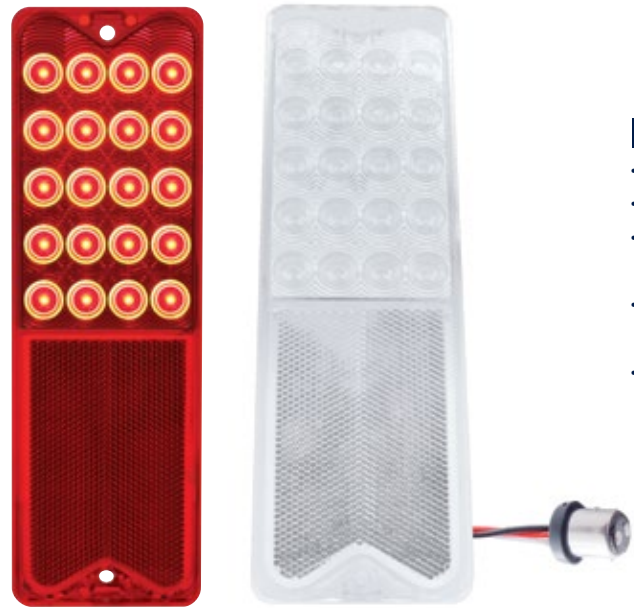

1967-72 Chevy Fleetside Truck

20 LED TAIL LIGHT

- 20 Super bright red LEDs
- Polycarbonate lens, epoxy coated, fully sealed electronics, 1157 plug
- Energy efficient solid state circuit board engineered for 7.7-14.0 VDC systems
- Recommended under dash flasher is item no. 90652 (2-Terminal) or 90651 (3-terminal)
- Sold individually

CTL6721LED | Red Lens
CTL6721C | Clear Lens

LED SEQUENTIAL TAIL LIGHTS



1967-72 Chevy & GMC Fleetside Truck

20 LED SEQUENTIAL TAIL LIGHT ASSEMBLY

- 20 Super bright red LEDs, complete with polycarbonate lens
- Includes steel tail light housing with socket and gasket
- Available with standard LED or sequential operation with selector switch to select sequential left, sequential right, or sequential function off
- Features sequential-once brake attention function
- Epoxy coated, fully sealed electronics, 1157 plug
- Solid state circuit boards are designed for 7.7-14.0 VDC
- Recommended under dash flasher is item no. 90652 (2-Terminal) or 90651 (3-terminal)

110213
110214

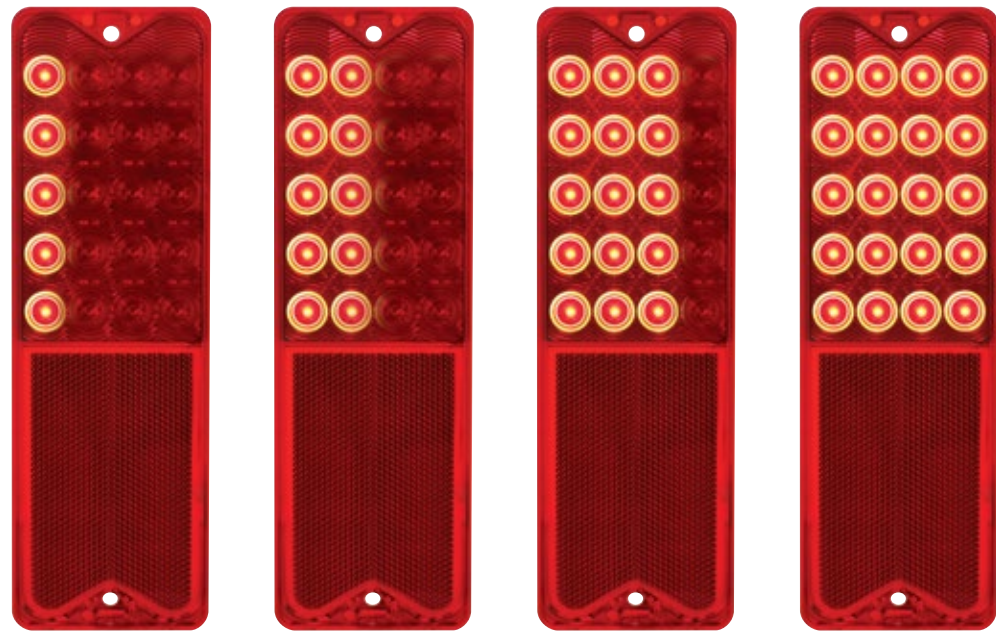

(((SEQUENTIAL)))
F · L · A · S · H

(((BRAKE)))
ATTENTION



(((SEQUENTIAL)))
F · L · A · S · H

(((BRAKE)))
ATTENTION



1967-72 Chevy & GMC Fleetside Truck

20 LED SEQUENTIAL TAIL LIGHT ASSEMBLY

- 20 Super bright red LEDs, complete with polycarbonate lens
- Available with standard LED or sequential operation with selector switch to select sequential left, sequential right, or sequential function off
- Features sequential-once brake attention function
- Complete with polycarbonate lens and LEDs sealed inside
- Easy electrical connection with 1157 plug, 12 volt only
- Recommended Under Dash Flasher Is Item No. 90652 (2-Terminal) Or 90651 (3-Terminal)
- Lifetime warranty

CTL6721SEQ



1967-72 Chevy & GMC Fleetside Truck

TAIL LIGHT LENS

- Sold individually

C677209

TAIL LIGHTS



1973-87 Chevy & GMC Truck

20 LED SEQUENTIAL TAIL LIGHT

- 20 Super bright red LEDs, with polycarbonate lens
- Mounting base plate included
- Features sequential operation with selector switch to select sequential left, sequential right, or sequential function off
- Features sequential-once brake attention function
- Epoxy coated, fully sealed electronics, 1157 plug
- Solid state circuit boards are designed for 7.7-14.0 VDC
- Recommended under dash flasher is item no. 90652 (2-Terminal) or 90651 (3-terminal)

CTL7387LED-L | LH/Driver

CTL7387LED-R | RH/Passenger



1973-87 Chevy & GMC Truck

TAIL LIGHT ASSEMBLY WITH TRIM

- Injection molded from high quality polycarbonate plastic
- Beautiful anodized aluminum trim
- Sold individually

C738705 | LH/Driver

C738704 | RH/Passenger



1988-02 Chevy & GMC Truck

TAIL LIGHT

- Injection molded from high quality polycarbonate plastic
- Fits 1988-98 Chevy C/K truck & 99-02 Chevy Silverado Classic
- 1992-99 Chevy Suburban / GMC Suburban
- 1995-99 Chevy Tahoe / GMC Yukon / GMC Denali (full-size)
- 1992-94 Chevy Blazer (full-size) & GMC Jimmy (full-size)
- Sold individually

110114 | LH/Driver

110115 | RH/Passenger

TAIL LIGHT BEZELS



1940-53 Chevy Truck

TAIL LIGHT BEZEL

- Sold individually

C4008-1 | Chrome

C4008-2 | Stainless Steel



1954-55 Chevy 1st Series Truck

STAINLESS STEEL TAIL LIGHT BEZEL

- Sold individually

C545506



1955-59 Chevy Truck

STAINLESS STEEL TAIL LIGHT BEZEL / GASKET

- Sold individually

C555909 | Bezel

C555911-3 | Gasket



1958-59 Chevy & GMC Fleetside Truck

TAIL LIGHT BEZEL

- Sold individually

C585902ALU | Aluminum

C585902SS | Stainless Steel



1960-66 Chevy & GMC Fleetside Truck

ANODIZED ALUMINUM TAIL LIGHT BEZEL

- Sold individually

C606603



1954-59 Chevy Truck

TAIL LIGHT RUBBER CONDUIT

- Universal tail light wiring boot for all restoration projects

- Total length: 21 1/2"

- Sold individually

C545504-2

T/L HOUSINGS / BRACKETS



1960-66 Chevy & GMC Fleetside Truck

TAIL LIGHT HOUSING, GASKET & PIGTAIL

- Zinc plated housing with socket
- Socket wiring pigtail sold separately: C606615
- Sold individually

C606614 | Tail Light Housing
C606651 | Lens Gasket
C606615 | Pigtail



1967-72 Chevy & GMC Fleetside Truck

TAIL LIGHT HOUSING

- Zinc plated housing with socket
- Socket wiring pigtail sold separately: C606615
- Sold individually

C677207 | Tail Light Housing
110215 | Lens Gasket Pair

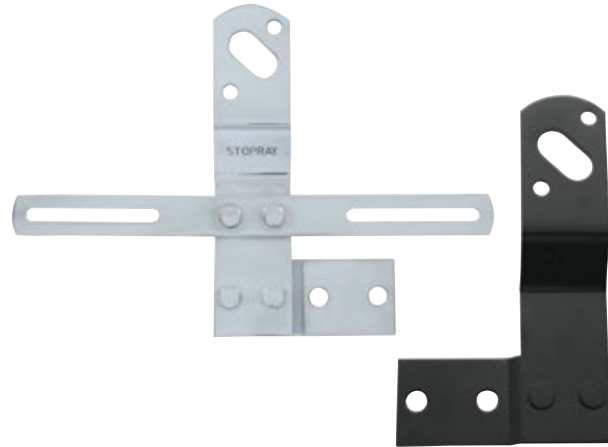

1947-53 Chevy & GMC 1st Truck

TAIL LIGHT BRACKET

- Sold individually

C7026RSS | Stainless Steel | RH/Passenger
C7026LSS | Stainless Steel | LH/Driver
C7003R | Black | RH/Passenger
C7003L | Black | LH/Driver
C7004R | Chrome | RH/Passenger
C7004L | Chrome | LH/Driver



1954-55 Chevy & GMC 1st Truck

TAIL LIGHT BRACKET

- Sold individually

C545502BK | Black | RH/Passenger
C545503BK | Black | LH/Driver
C545502CR | Chrome | RH/Passenger
C545503CR | Chrome | LH/Driver
C545502SS | Stainless Steel | RH/Passenger
C545503SS | Stainless Steel | LH/Driver



1955-66 Chevy & GMC 1st Truck

TAIL LIGHT BRACKET

- Sold individually

C556601BK | Black | RH/Passenger
C556602BK | Black | LH/Driver
C556601CR | Chrome | RH/Passenger
C556602CR | Chrome | LH/Driver
C556601SS | Stainless Steel | RH/Passenger
C556602SS | Stainless Steel | LH/Driver

TL GASKET / BACKUP LIGHTS

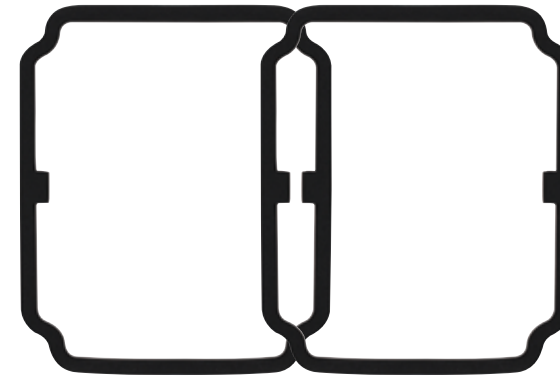

1973-87 Chevy & GMC Truck

TAIL LIGHT LENS GASKET

- Black EVA foam
- Precision die cut to OE specifications for a perfect fit
- Sold in pairs

C738703



1967-72 Chevy & GMC Truck

BULLSEYE STYLE BACKUP LIGHT LENS

- Rare 1967-68 bullseye style circular pattern
- Sold individually

110362



1967-72 Chevy & GMC Truck

BACKUP LIGHT LENS

- Injection molded high quality polycarbonate plastic
- Sold in pairs

110216



1967-72 Chevy & GMC Truck

30 LED BACKUP LIGHT

- 30 white super bright LEDs, with desirable bullseye lens
- Epoxy coated, fully sealed electronics, 1156 plug
- Solid state circuit boards are designed for 7.7-14.0 VDC

110200 | LH/Driver

110201 | RH/Passenger



1955-58 Chevy Cameo Truck

BACKUP LIGHT LENS

- Injection molded high quality polycarbonate plastic
- Sold in pairs

C7007

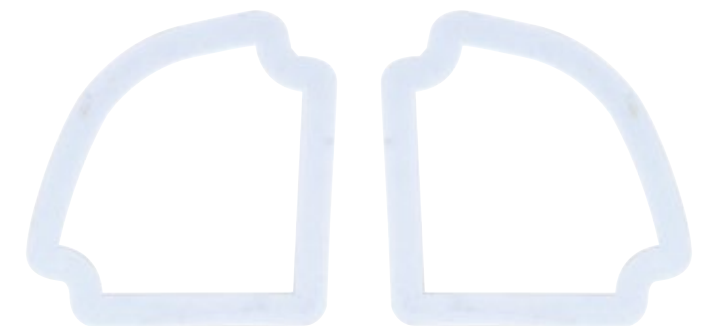

1967-72 Chevy & GMC Truck

BACKUP LIGHT GASKET

- White foam rubber like the original
- Fits between tail light housing and lens
- Sold in pairs

110202

LED PARKING LIGHTS



LED PARKING LIGHTS



1960-66 Chevy & GMC Truck

LED PARKING LIGHT

- 33 amber super bright LEDs, polycarbonate lens
 - Dual function with parking light and turn signal
 - Epoxy coated, fully sealed electronics, 1157 plug
- CPL6066A**

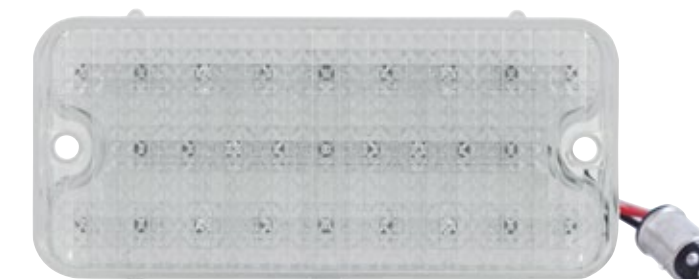
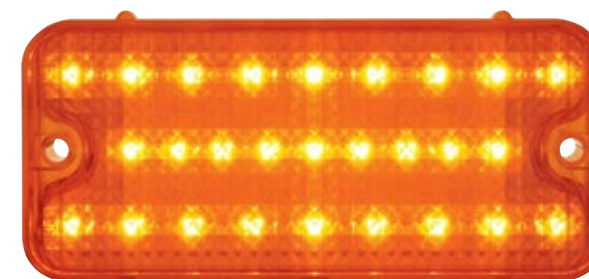

1967-68 Chevy & GMC Truck

LED PARKING LIGHT

- 27 amber super bright LEDs, polycarbonate lens
 - Dual function with parking light and turn signal
 - Epoxy coated, fully sealed electronics, 1157 plug
- CPL6768A | Amber**
CPL6768C | Clear

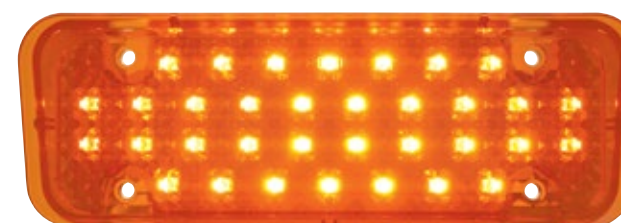

1971-72 Chevy & GMC Truck

LED PARKING LIGHT

- 34 super bright amber LEDs, polycarbonate lens
 - Dual function, epoxy coated, fully sealed electronics, 1157 plug
 - Fits LH/Driver and RH/Passenger
- CPL7172A | Amber**
CPL7172C | Clear



LED PARKING LIGHTS

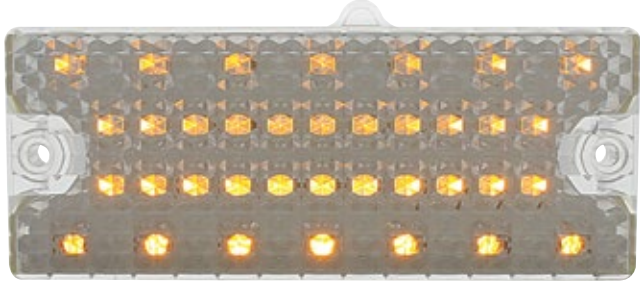
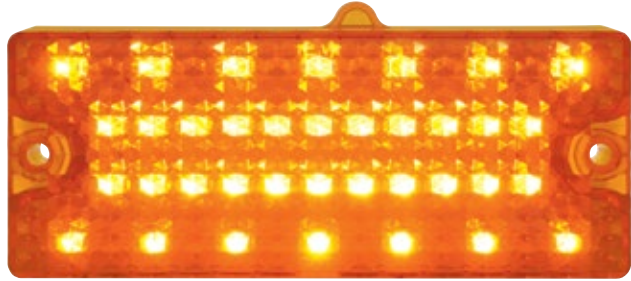
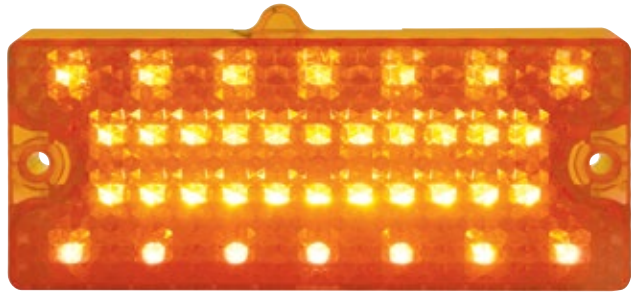

1969-70 Chevy & GMC Truck

LED PARKING LIGHT

- 36 amber super bright LEDs, with amber polycarbonate lens
- Dual function with parking light and turn signal
- Epoxy coated, fully sealed electronics, 1157 plug

CPL6970AL | LH/Driver

CPL6970AR | RH/Passenger

1969-70 Chevy & GMC Truck

LED PARKING LIGHT

- 36 amber super bright LEDs, with clear polycarbonate lens
- Dual function with parking light and turn signal
- Epoxy coated, fully sealed electronics, 1157 plug

CPL6970CL | LH/Driver

CPL6970CR | RH/Passenger

LED PARKING LIGHTS



1947-53 Chevy & GMC Truck

LED PARKING LIGHT ASSEMBLY

- Complete parking light assembly with LED lens installed
- Polished stainless steel bezel, black housing with socket and wires
- 24 amber super bright LEDs, polycarbonate lens
- Dual function with parking light and turn signal
- Epoxy coated, fully sealed electronics, 1157 plug

CPL4753A-AS | Amber

CPL4753C-AS | Clear



1951-53 GMC Truck

LED PARKING LIGHT

- Amber LEDs with clear lens

CPL5153C

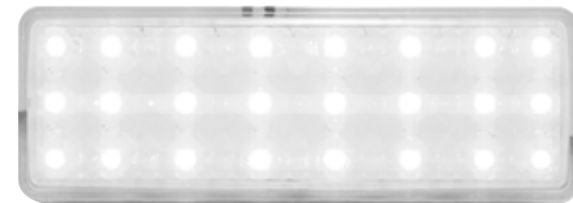
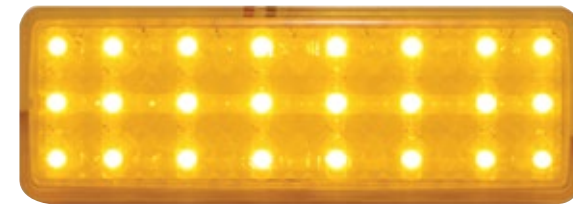

1947-53 Chevy & GMC Truck

LED PARKING LIGHT LENS

- 24 super bright LED parking light lens
- High quality injection molded polycarbonate lens
- Dual function with parking light and turn signal
- Epoxy coated, fully sealed electronics, 1157 plug

CPL4753A | Amber

CPL4753C | Clear



1955-57 Chevy & GMC Truck

LED PARKING LIGHT

- 39 super bright LED parking light
- Polycarbonate lens with LEDs sealed inside
- Dual function with parking light and turn signal
- Easy electrical connection with 1157 plug, 12 volt only

CPL5557A | Amber

CPL5557C | Clear

PARKING LIGHT LENS



1942-46 Chevy Truck
GLASS PARKING LIGHT LENS
 • Excellent quality all glass lens
 • Sold individually
C7010



1951-53 GMC Truck
PARKING LIGHT LENS
 • Injection molded from high quality polycarbonate plastic
 • Sold individually
C515301 | Clear



1955-57 Chevy Truck
PARKING LIGHT LENS
 • Injection molded from high quality polycarbonate plastic
 • Sold individually
C7014A | Amber
C7014C | Clear



1947-53 Chevy Truck
CLEAR GLASS PARKING LIGHT LENS
 • Fits LH/Driver or RH/Passenger
 • Sold individually
C7019



1955-57 Chevy Truck
PARKING LIGHT LENS
 • Great looking replacement with new lens pattern
 • Injection molded from high quality polycarbonate plastic
C555751A | Amber
C555751C | Clear



1958-59 Chevy Truck
PARKING LIGHT LENS
 • Fits LH/Driver or RH/Passenger
 • Injection molded from high quality polycarbonate plastic
 • Sold individually
C7009A | Amber
C7009C | Clear

PARKING LIGHT LENS

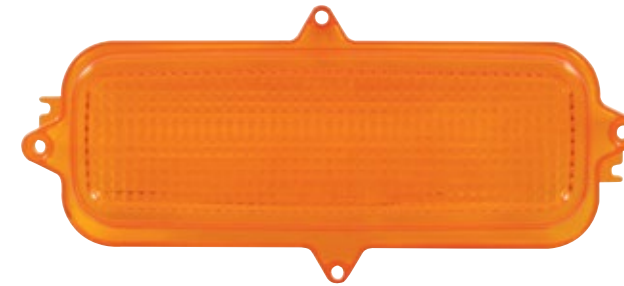
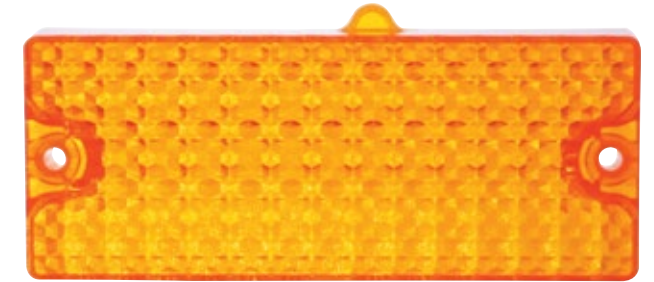

1960-66 Chevy Truck
PARKING LIGHT LENS
 • Injection molded from high quality polycarbonate plastic
 • Sold individually
C606621 | Amber

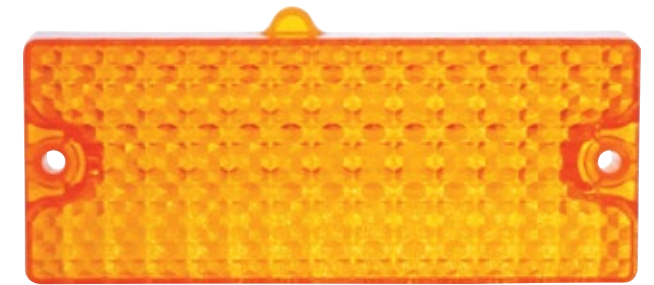

1969-70 Chevy Truck
PARKING LIGHT LENS
 • Injection molded from high quality polycarbonate plastic
 • Sold individually
C697020 | Amber LH/Driver
C697021 | Amber RH/Passenger

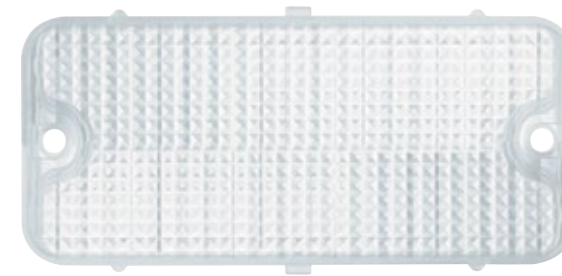
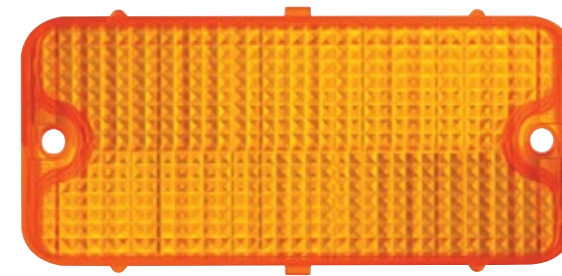

1967-68 Chevy Truck
PARKING LIGHT LENS
 • Injection molded from high quality polycarbonate plastic
 • Sold individually
C676811A | Amber
C676811C | Clear

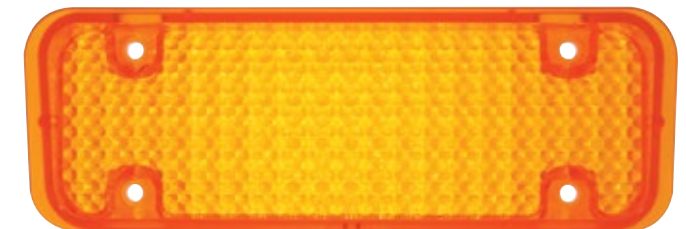

1971-72 Chevy Truck
PARKING LIGHT LENS
 • Injection molded from high quality polycarbonate plastic
 • Fits LH/Driver and RH/Passenger
 • Sold individually
C717221 | Amber

PARKING LIGHT BEZELS



1947-53 Chevy & GMC Truck

STAINLESS STEEL PARKING LIGHT BEZEL

- Polished stainless steel
- Sold individually

C475307



1947-53 Chevy & GMC Truck

CHROME PARKING LIGHT BEZEL

- Chrome plated
- Sold individually

C475307CR



1962-66 Chevy & GMC Truck

PARKING LIGHT BEZEL

- Sold individually

C626601



PARKING GASKETS



1960-66 Chevy Truck

FRONT PARKING LIGHT LENS GASKET

- Great looking OEM style replacement lens
- Injection molded from high quality polycarbonate plastic

C606612



1971-72 Chevy Truck

FRONT PARKING LIGHT LENS GASKET

- Sold in pairs

C717201



1967-68 Chevy & GMC Truck

FRONT PARKING LIGHT LENS GASKET

- Black foam rubber like the original
- Sold individually

C676812



1947-53 Chevy & GMC Truck

FRONT PARKING LIGHT LENS GASKET

- Black foam rubber like the original
- Sold individually

C475308



1951-53 GMC Truck

FRONT PARKING LIGHT LENS GASKET, LENS

- Black foam rubber like the original
- Sold in pairs

C515321 | Lens Gasket
C515301 | Lens

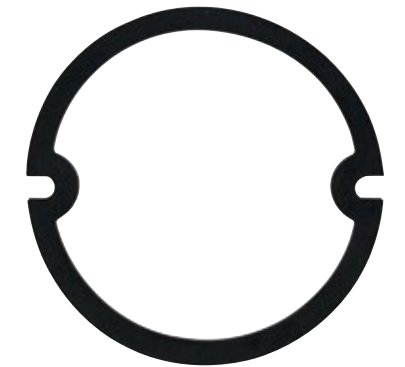

1955-57 Chevy & GMC Truck

FRONT PARKING LIGHT LENS GASKET

- Black foam rubber like the original
- Sold in pairs

C555755

SIDE MARKERS



SIDE MARKERS



1968-72 Chevy Truck

18 LED SIDE MARKER LIGHT W/ STEEL TRIM

- 18 super bright LEDs, complete with polycarbonate lens
- Epoxy coated fully sealed electronics
- Solid state circuit boards are designed for 7.7 - 14.0 VDC
- Dual function, parking light and turn signal

CML6872A | Front Amber

CML6872R | Rear Red

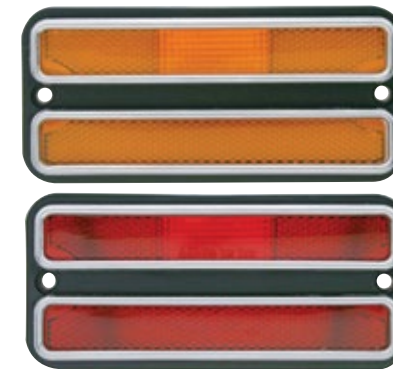

1968-72 Chevy & GMC Truck

SIDE MARKER LIGHT W/ STEEL TRIM

- Deluxe side marker lamp lens with stainless steel trim
- Also fits Blazer, Jimmy and Suburban
- Gasket included, sold individually

C687202 | Front Amber

C687203 | Rear Red

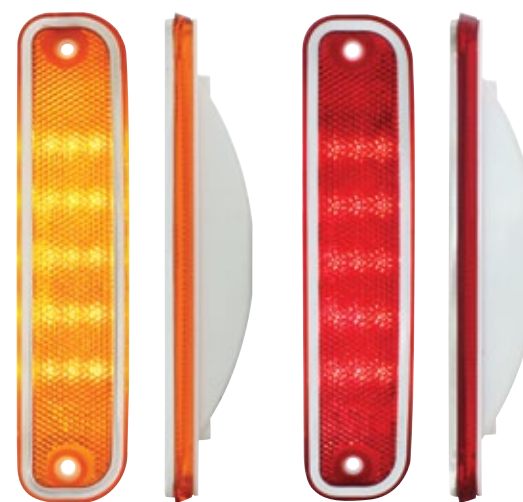

1973-80 Chevy & GMC Truck

LED FRONT SIDE MARKER LIGHT

- Polycarbonate lens with stainless steel trim
- Fits LH/Driver and RH/Passenger
- Sold individually

CML7380A | Amber

CML7380R | Red



1973-80 Chevy & GMC Truck

SIDE MARKER LIGHT W/ STAINLESS STEEL TRIM

- Polycarbonate lens with polished deluxe stainless steel trim
- Also fits 1973-91 Chevy & GMC Crew Cab Dually
- Fits LH/Driver and RH/Passenger side
- Sold individually

C738002 | Amber Side Marker Light

C738003 | Red Side Marker Light

C738001 | Clear Side Marker Light



1967-91 Chevy & GMC Truck

SIDE MARKER SOCKET

- Replaces damaged or missing OE sockets
- Includes butt connectors
- 194 bulb sold separately

C679101 | Side marker socket kit

39043 | Two 194 clear bulbs

MISC. LIGHTS / LENS



Universal

1004 DOME LIGHT BULB

- Single filament
- Sold individually

39065



1955-59 Chevy Truck

DOME LIGHT LENS

- Sold individually

C555901



1969-72 Chevy & GMC Truck

INCANDESCENT CARGO LIGHT ASSEMBLY

- Great looking OEM style replacement lens
- Injection molded from high quality polycarbonate plastic

110446



1969-72 Chevy & GMC Truck

CARGO LIGHT GASKET

- White foam rubber like the original
- Also fits 1969 Camaro backup light

110217

MISC. LIGHTS / LENS



1969-72 Chevy & GMC Truck

CARGO LIGHT LENS

- Great looking OEM style replacement lens
- Injection molded from high quality polycarbonate plastic

110168



1969-72 Chevy & GMC Truck

18 LED 3RD BRAKE & CARGO LIGHT

- 18 white LED cargo light with 9 red LED 3rd brake light feature
- Plug & play with 1004 double contact plug like the original
- Third brake light requires additional wiring, wiring instructions included
- Epoxy coated, fully sealed electronics
- Energy efficient solid state circuit board engineered for 12 VDC systems

110127



Universal

STAINLESS STEEL TAIL LIGHT WIRE CONDUIT

- Sold in pairs

C5025 | 12"

C5026 | 19"

CARGO / LICENSE LIGHT



1940-53 Chevy Truck

6 LED AUXILIARY/LICENSE LIGHT

- 6 super bright white LEDs
- Epoxy coated, fully sealed electronics
- Energy efficient solid state circuit board engineered for 7.7-14.0 VDC systems

CTL4053LL



1940-43 Chevy Truck

LICENSE LIGHT LENS GASKET

- Also fits 1937-38 Chevy car

C7001G



1940-53 Chevy & GMC Truck

CLEAR TAIL LIGHT LICENSE LENS

- Approximately 2 5/16" wide, 1 7/16" tall, 7/8" depth
- Sold individually

C7021



Universal

2 LED AUXILIARY/LICENSE LIGHT

- 2 super bright LED auxiliary/license light, water resistant with chrome housing
- 2 wires, (hard wired), hole distance 3 1/2" center to center

39994B



Universal

1 LED LICENSE PLATE FASTENER (2 PACK)

- Stainless steel fastener with super bright LED
- 8 1/2" wire lead, 2 wires (hard wired)
- Requires 5/16" diameter hole for installation

70300 | Amber

70301 | Blue

70302 | Red

70303 | White

LICENSE PLATE BRACKET W/ LIGHT



1954-59 Chevy & GMC Truck

REAR LICENSE PLATE BRACKET W/ LIGHT

- Die stamped with high quality 17 gauge sheet metal
- Original style license plate light with quality glass & metal enclosure, original style large riveted license plate bracket
- Single positive lead wire with quick connector pre-installed electrical hookup
- Black EDP coated

110770



1960-66 Chevy Truck

REAR LICENSE PLATE BRACKET W/ LIGHT

- Die stamped with high quality 17 gauge sheet metal
- Original style license plate light with quality glass enclosure, original style large riveted license plate bracket
- Single positive lead wire with quick connector pre-installed electrical hookup, black rubber insert to reduce rattling noise from license plate
- Black EDP coated

110771



FRONT BUMPERS



1947-72 Chevy Truck

CHROME FRONT BUMPERS

- Quality heavy stamped steel bumpers with all original detail and mounting holes
- Chrome plated

- 105471 | 1947-54
- 105551 | 1955-59
- 105601 | 1960-62
- 105631 | 1963-66
- 105671 | 1963-66
- 105672 | 1967-72
- 105711 | 1971-72



1938-46 Chevy Truck

STAINLESS STEEL BUMPER BOLT

- 1/2-13 thread
- C383901

REAR BUMPERS

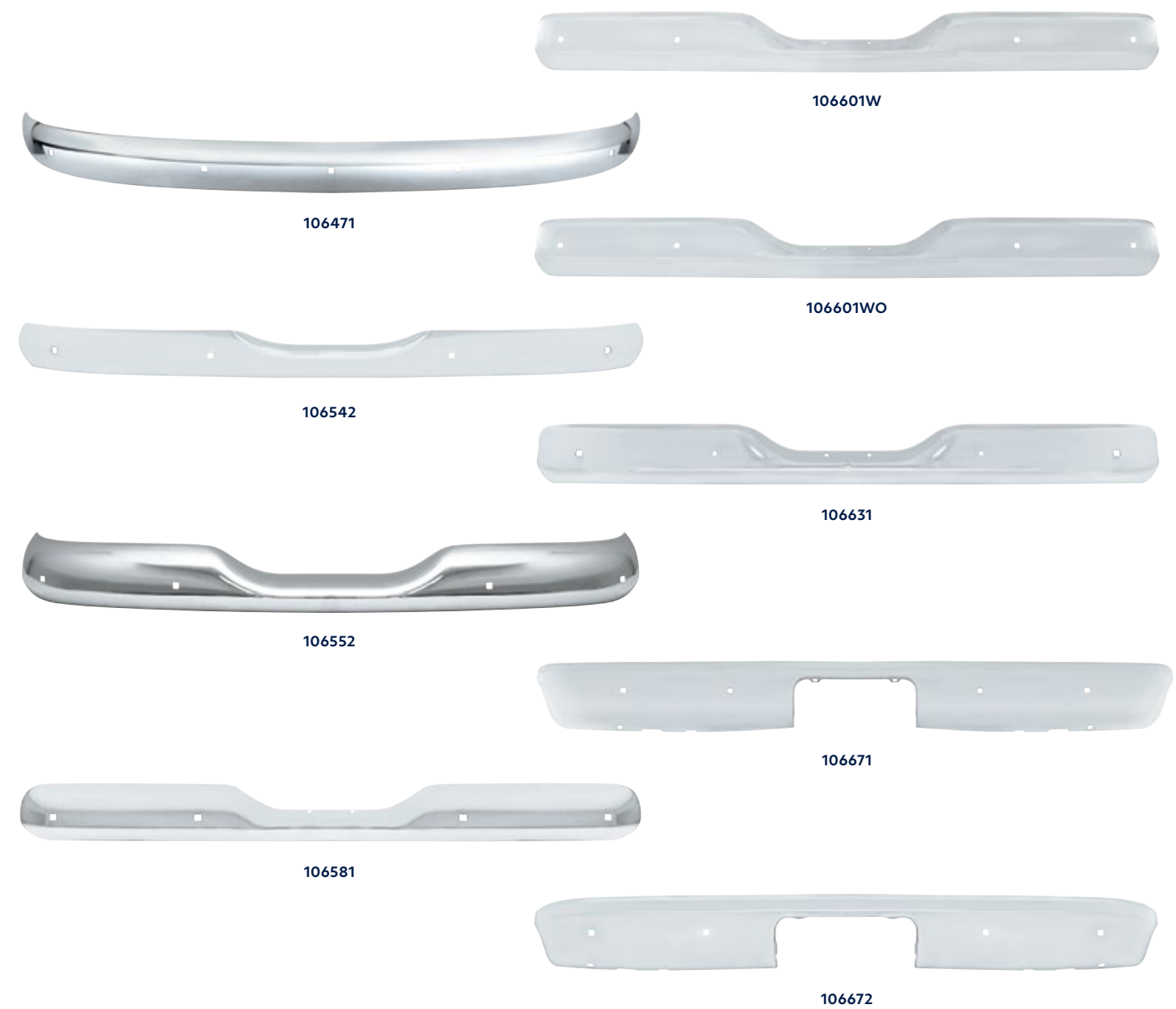

1947-72 Chevy Truck

CHROME REAR BUMPERS

- Quality heavy stamped steel bumpers with all original detail and mounting holes
- Chrome plated

- 106471 | 1947-53
- 106542 | 1954-55
- 106552 | 1955-59
- 106581 | 1958-59
- 106601W | 1960-62
- 106601WO | 1960-62
- 106631 | 1963-66
- 106671 | 1967-72
- 106672 | 1962-72



1947-72 Chevy Truck

CHROME BUMPER BOLT

- 1/2-13 thread
- 1 Piece, includes flat washer, lock washer and nut
- C477204

FRONT BUMPERS



1947-72 Chevy & GMC Trucks

BLACK EDP COATED FRONT BUMPERS

- Quality heavy stamped steel bumpers with all original detail and mounting holes
- Black EDP coated finish

110729 | 1947-55 Chevy & GMC Trucks

110728 | 1955-59 Chevy & GMC Trucks

110721 | 1960-62 Chevy & GMC Trucks

110722 | 1963-66 Chevy & GMC Trucks

110718 | 1967-70 Chevy, 1967-68 GMC

110719 | 1967-72 GMC Trucks

110720 | 1970-72 Chevy Trucks

REAR BUMPERS

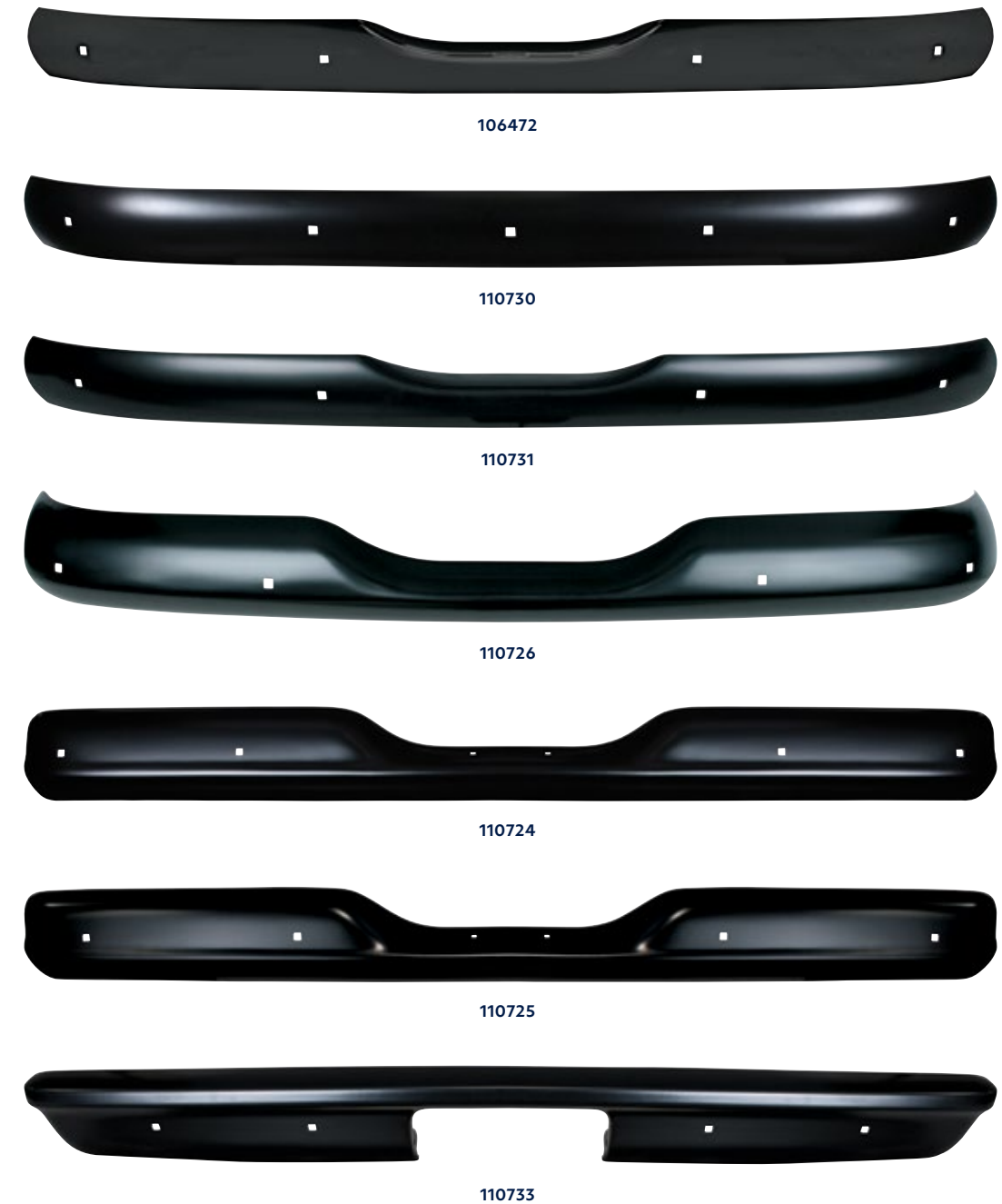

1947-72 Chevy & GMC Trucks

BLACK EDP COATED REAR BUMPERS

- Quality heavy stamped steel bumpers with all original detail and mounting holes
- Black EDP coated finish

106472 | 1947-53 Chevy & GMC Trucks

110730 | 1947-53 Chevy & GMC Trucks

110731 | 1954-55 Chevy & GMC Trucks

110726 | 1955-59 Chevy & GMC Stepside Trucks

110724 | 1960-62 Chevy & GMC Fleetside Trucks

110725 | 1963-66 Chevy & GMC Trucks

110733 | 1967-87 Chevy & GMC Stepside Trucks



1947-53 Chevy & GMC Truck

CHROME GRILLE GUARD

- Chrome grille guard with chrome hardware
 - Mounts behind front bumper, fits up to 6' wide bumpers
- C475313**



1955-56 Chevy Truck

CHROME GRILLE

- Steel reproduction of the original truck grille
 - Beautiful triple chrome plating
- 110387**



1955-56 Chevy Truck

BLACK PAINTED GRILLE

- Quality 19 gauge steel reproduction, black EDP finish
 - Has all original bar spacing and contour
 - Includes 5/16-18 square nuts for quick and easy installation
- 110388**



1957 Chevy Truck

CHROME GRILLE

- Steel reproduction of the original truck grille
 - Beautiful triple chrome plating
- 110389**



1957 Chevy Truck

WHITE POWDER COATED GRILLE

- Excellent steel reproduction of the original truck grille
 - Includes 5/16-18 nuts pre-welded to grille for quick and easy installation
 - Powder coated with original factory color look
- 110390**

HOOD PARTS



1947-54 Chevy Truck

CHROME HOOD LATCH PANEL

- Heavy duty triple chrome plated stamped steel
- Has radiator, fender, and grille bar mounting bolt holes
- Includes pre-installed hood latch

110340



1947-54 Chevy Truck

BLACK EDP COATED HOOD LATCH PANEL

- Die stamped 18 gauge steel
- Has radiator, fender, and grille bar mounting bolt holes
- Includes pre-installed hood latch

110339



1955-57 Chevy Truck

HOOD LATCH PANEL

- Made with high quality 20 gauge sheetmetal
- Features all original contour and detail
- Black EDP coated

110341



1958-59 Chevy Truck

HOOD LATCH PANEL

- Stamped steel reproduction of the original
- Has radiator, fender, and grille bar mounting bolt holes
- Black EDP coated

110342



1947-54 Chevy & GMC Truck

HOOD SAFETY CATCH

- Die stamped steel, spring loaded like the original
- Black EDP coated
- Also fits 1955 1st series

110279



1955-57 Chevy & GMC

HOOD LATCH ASSEMBLY

- Die stamped with heavy gauge sheetmetal
- Zinc plated
- Sold in pairs

110280

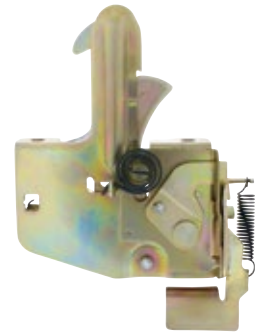

1958-59 Chevy & GMC

HOOD LATCH ASSEMBLY

- Die stamped with heavy gauge sheetmetal
- Features all the original mechanical design
- Pre-assembled for easy installation

110281



Chevy 327/350 Motor

CHROME 45 DEGREE WATER NECK

- Straight forward, 45 degree up chrome water neck
- Quality zinc die-cast with beautiful chrome plated finish
- Comes complete with thermostat housing, bolts and o-ring

110344

HOOD PARTS



1947-55 Chevy & GMC Truck

1st SERIES TRUCK HOOD HINGE AND SUPPORT

- Heavy duty steel reproduction of the original hood hinge
- Includes hood support arm with clock spring
- Black EDP coated
- Sold individually, please specify driver or RH/Passenger

110249 | L/H

110250 | R/H



Chevy Small Block Gen 1 & GM V6

CHROME 15 DEGREE WATER NECK

- Angled left 15 degree up chrome water neck
- Quality zinc die-cast with beautiful chrome plated finish
- Comes complete with thermostat housing, bolts and o-ring

110345

BATTERY HOLD DOWN FRAMES



1955-59 Chevy Truck

BATTERY HOLD DOWN BOLT SET

- Clear zinc plated hold down bolts with washers, and nuts
- Sold in pairs

110807



1958-66 Chevy & GMC Truck

BATTERY HOLD DOWN BRACKET

- High grade 304 stainless steel
- Identical design of the original

110473



1958-66 Chevy & GMC Truck

BATTERY HOLD DOWN BRACKET

- Excellent reproduction of the original design
- Die stamped steel
- Anti-Corrosive black powder coated finish

110472



1947-55 Chevy & GMC Truck

BATTERY TRAY HOLD DOWN FRAME

- Excellent reproduction of the original design
- Die stamped steel, painted black

110470



1955-57 Chevy & GMC Truck

BATTERY HOLD DOWN FRAME

- Excellent reproduction of the original design
- Die stamped steel, painted black
- Fits group-24 battery size

110471

BATTERY TRAYS



C475501



C555711



C585911



C606604



C677203



C677212



C738011

1967-72 Chevy & GMC Truck

BATTERY TRAYS

- Heavy duty stamped steel
- Black powder coated

C475501 | 1947-55

C555711 | 1955-57

C585911 | 1958-59

C606604 | 1960-66

C677203 | 1967-72

C677212 | 1967-72

C738011 | 1973-80

EXTERIOR MIRROR KITS



EXTERIOR MIRROR KITS

1970-72 Chevy & GMC Truck

EXTERIOR MIRROR WITH LED TURN SIGNAL

- Winner NSRA safety product of the year
- 9 red LED arrow hidden inside mirror glass
- Polished stainless steel mirror head & chrome plated arm
- Mounting hardware included
- Easy hookup, route wire through door jamb and connect to front turn signal wires under dash near steering column
- Can also be used on older 1967-69 trucks

110749 | Bundle LH and RH Included
C707201-LED | LH/Driver
C707202-LED | RH/Passenger



1973-87 Chevy & GMC Truck

CONVEX EXT. MIRROR W/ LED TURN SIGNAL RH

- LED turn signal arrow hidden inside mirror glass
- Beautiful die-cast & chrome plated mirror head and arm
- Convex mirror for wide angle visibility
- Easy hookup, route wire through door jamb and connect to front turn signal wires under dash near steering column
- Includes mounting pad, mounting bracket and screws

C738710-CVXLED | RH/Passenger Convex
C738710-LED | LH/Driver

EXTERIOR MIRROR KITS



1970-72 Chevy & GMC Truck

EXTERIOR MIRRORS

- Convex mirror with wide angle optics for RH side
 - Polished stainless steel mirror head & chrome plated arm
 - Mounting pads and hex wrench included
 - Bundle includes: C707201 & C707202 pre-packed in one box
- 110748** | Bundle LH and RH Included
C707201 | LH/Driver
C707202 | RH/Passenger



1973-87 Chevy & GMC Truck

CONVEX EXTERIOR MIRROR

- Chrome finish
 - Also fits 1951-52 Chevy passenger car
- C738710-CVX**



1973-87 Chevy & GMC Truck

EXTERIOR MIRROR KIT

- Hardware included
 - Fits LH/Driver or RH/Passenger, sold individually
- C738710**

EXTERIOR MIRROR KITS

Universal

4" PEEP MIRROR WITH LED TURN SIGNAL

- 7 red LED arrow hidden behind mirror glass
 - Wiring is discreetly routed through groove in arm
 - Polished stainless steel mirror head with chrome plated arm
 - Mounting pad and hex wrench included
 - 12V only, includes 48" of wire
 - Bundle includes: C5001-led & C5001-1CVXLED pre-packed in one box
- 110743** | Mirror Bundle
C5001-LED | LED Mirror
C5001-CVXLED | Convex LED Mirror



Universal

4" CURVED ARM PEEP MIRROR

- Polished stainless steel mirror head with chrome plated arm
 - Convex mirror has Improved wide angle vision on passenger side
 - Mounting pad and hex wrench included
 - Sold individually
- C5001**



Universal

4" CURVED ARM CONV. PEEP MIRROR BUNDLE

- Polished stainless steel mirror head with chrome plated arms
 - Convex mirror has Improved wide angle vision on passenger side
 - Mounting pad and hex wrench included
 - Bundle includes: C5001 & C5001-CVX pre-packed in one box
- 110742** | Mirror Bundle

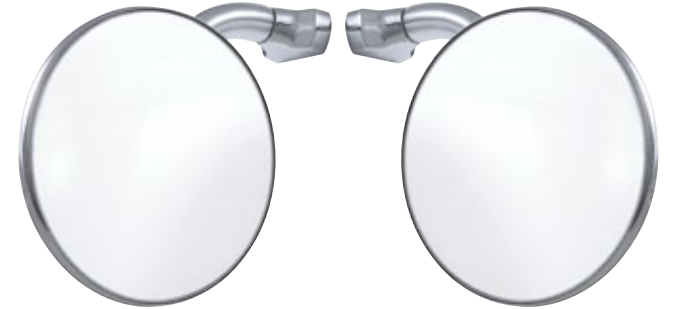

Universal

3" CURVED ARM CONV. PEEP MIRROR BUNDLE

- Polished stainless steel mirror head with chrome plated arms
 - Convex mirror has Improved wide angle vision on passenger side
 - Mounting pad and hex wrench included
 - Bundle includes: C5001-1 & C5001-1CVX pre-packed in one box
- 110741** | Mirror Bundle
C5001-1 | Standard Mirror
C5001-1CVX | Convex Mirror

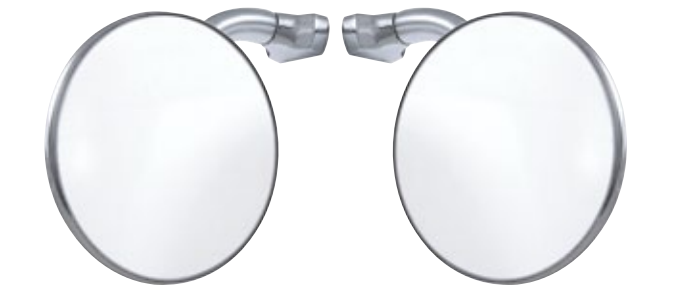

EXTERIOR MIRROR KITS



EXTERIOR MIRROR KITS



1973-91 Chevy & GMC Full Size Truck & Van

MIRROR

- Exterior rectangular rear view mirror with chrome housing
- Includes mounting pad and mounting hardware
- Sold individually

60050



Universal

STAINLESS SWING AWAY MIRROR

- Low mount stainless steel truck mirror housing, arms and yoke
- Fits most pickups, vans, smaller RVs and campers
- Extends to 15", double strength tubing reduces vibration
- Swing-away function helps vehicle fit into tight parking spots

60039

EXTERIOR MIRROR HEADS



1947-55 Chevy & GMC Truck 5" EXTERIOR MIRROR HEAD

- Gloss powder coated mirror, 1/4" male stud on back
- Sold individually

C477201 | Black, Ribbed
 C476901 | Chrome, Ribbed
 C476903B | Black, Smooth
 C477202 | Chrome, Smooth



1947-72 Chevy & GMC Truck EXTERIOR MIRROR HEAD

- 6"x8" mirror head, 1/4 - 20 male stud with nut
- Sold individually

C476902 | Stainless Steel
 C476904 | Black

EXTERIOR MIRROR ARMS



1947-55 Chevy & GMC Truck EXTERIOR MIRROR ARM

- Die-cast exactly like the original
- Chrome mirror heads available separately, C476901, C477202
- Black mirror heads available separately, C477201, C476903B

C475510 | RH/Passenger | Powder Coated Black
 C475511 | LH/Driver | Chrome
 C475512 | RH/Passenger | Powder Coated Black
 C475513 | LH/Driver | Chrome

1955-59 Chevy & GMC 2nd Series Truck EXTERIOR MIRROR ARM

- Die-cast exactly like the original
- Fits all 2nd series trucks, Panel truck, and Suburban
- Chrome mirror heads available separately, C476901, C477202
- Black mirror heads available separately, C477201, C476903B

C555941 | LH/Driver | Powder Coated Black
 C555942 | RH/Passenger | Powder Coated Black
 C555943 | LH/Driver | Chrome
 C555944 | RH/Passenger | Chrome

WIPER BLADES

Universal

ELECTRIC WIPER MOTOR SET

- Stainless steel wiper arm, 11" long blade and built-in switch on black motor cover
- Approximately 110 degree swing
- 1 3/4" center shaft to side hold mounting
- 3 1/4" long threaded shaft

A6235



Universal

ELECTRIC WIPER MOTOR SET

- Electric wiper motor set, stainless with wiper arm & blade
- 12 volt with self park, neoprene stem seal
- 1 3/4" center shaft to side hold mounting
- 3 1/4" long threaded shaft

A6236



Universal

WIPER BLADES

- Hook style, polished stainless steel wiper blades
- Sold individually

A7026 | 8"

A7037 | 9"

A7027 | 10"



Universal

WIPER BLADES

- Wrist style, polished stainless steel wiper blades
- Used with wiper arms with spoon shape ends
- Sold individually

110300 | 6"

110301 | 8"

110302 | 9"

110303 | 10"

110304 | 11"

110305 | 12"

110306 | 15"



WIPER ARMS / LINKAGE

1947-72 Chevy & GMC Truck

WIPER ARMS

- Polished stainless steel with die-cast chrome plated mounts
- Item #: 190671, and 190672 have bayonet end and use 15" wiper blade item #: 110306
- Sold individually

190471 | 1947-53 Truck | LH/Driver

190472 | 1947-53 Truck | RH/Passenger

190541 | 1954-59 Truck | LH/Driver

190542 | 1954-59 Truck | RH/Passenger

190601 | 1960-66 Truck | LH/Driver

190602 | 1960-66 Truck | RH/Passenger

190671 | 1967-72 Truck | LH/Driver or RH/Passenger Side



190541



190542



190601



190602



190671



190672

1960-66 Chevy & GMC

WIPER TOWER & LINKAGE SET

- Complete wiper linkage set with die-cast wiper shaft towers, pivots, and link arms
- Sold as a set

110243



REAR VIEW MIRRORS



Universal
INTERIOR REAR VIEW MIRROR
 • Rectangular stainless steel rear view mirror
 • Easy installation, simply glue onto windshield glass
 • Recommended adhesive: Loctite 37438, Permatex 81840, 3M 08752
M1003

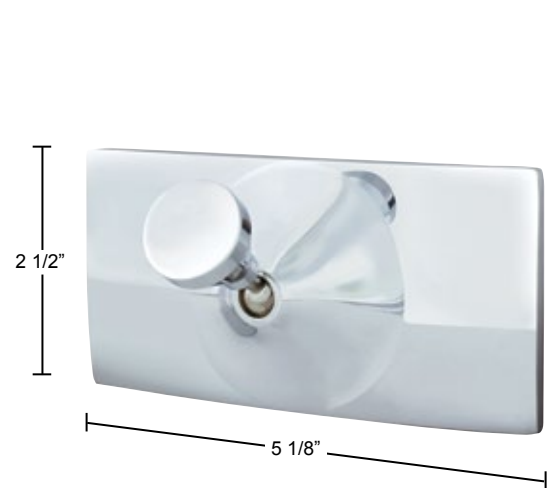

Universal
INTERIOR REAR VIEW MIRROR
 • Rectangular chrome plated aluminum rear view mirror
 • Easy installation, simply glue onto windshield glass
 • Recommended adhesive: Loctite 37438, Permatex 81840, 3M 08752
70801

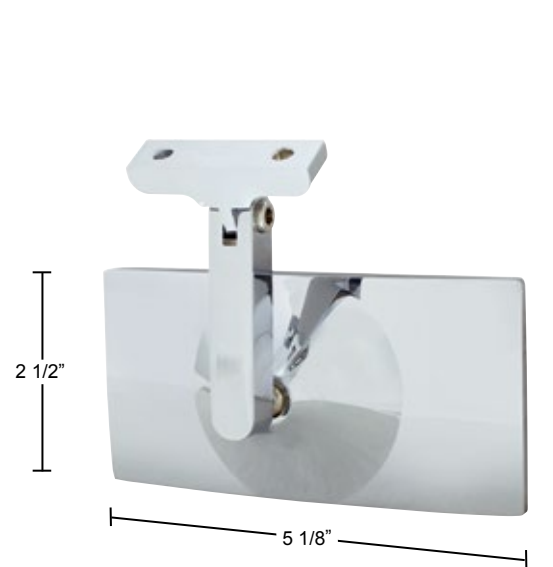

Universal
INTERIOR REAR VIEW MIRROR
 • Rectangular chrome plated aluminum rear view mirror
 • Easy installation, simply glue onto windshield glass
 • Recommended adhesive: Loctite 37438, Permatex 81840, 3M 08752
70803



REAR VIEW MIRRORS



Universal
INTERIOR REAR VIEW MIRROR
 • Oval chrome plated aluminum rear view mirror
 • Easy installation, simply glue onto windshield glass
 • Recommended adhesive: Loctite 37438, Permatex 81840, 3M 08752
70804



Universal
INTERIOR REAR VIEW MIRROR
 • Oval chrome plated aluminum rear view mirror
 • Easy installation, simply glue onto windshield glass
 • Recommended adhesive: Loctite 37438, Permatex 81840, 3M 08752
70802



REAR VIEW MIRRORS



1947-53 Chevy & GMC Truck

INTERIOR REAR VIEW MIRROR

- Chrome finish
- Also fits 1951-52 Chevy passenger car

C475310CR



1947-59 Chevy & GMC Truck

INTERIOR REAR VIEW MIRROR

- Polished stainless steel housing, mirror glass installed in housing with smooth edges

C475902



1953-59 Chevy & GMC Truck

INTERIOR REAR VIEW MIRROR

- Chrome finish
- Also fits 1953-54 GM passenger car

C535910CR

REAR VIEW MIRRORS



1960-71 Chevy & GMC Truck

INTERIOR REAR VIEW MIRROR

- Polished stainless steel housing, mirror glass installed in housing with smooth edges
- Mirror arm sold separately, C607111

C607110



1953-59 Chevy & GMC Truck

CHROME INSIDE MIRROR HOUSING

- Chrome finish
- Also fits 1953-54 GM passenger car

C475310



1960-71 Chevy & GMC Truck

REAR VIEW MIRROR BRACKET

- Chrome finish

C607111



1947-53 Chevy & GMC Truck

INTERIOR MIRROR BRACKET

- Shaped exactly like the original, polished stainless steel
- Mounts on windshield division bar
- Use with United Pacific mirrors or C475310CR

C475351



1960-71 Chevy & GMC Truck

INTERIOR MIRROR BRACKET SCREW

- Polished stainless steel mirror Screw

C607112

GAUGE PACKAGES



GAUGE PACKAGES BY



1955-59 Chevy Truck

TACH FORCE STYLE GAUGE PACKAGE

- Six in one package (Fuel 0-30 OHM)

110019

1947-72 Chevy & GMC

SPEEDOMETER CABLE

- 68" speedometer cable

C477203



1967-72 Chevy

G-STOCK GAUGE PACKAGE

- 5" Speed/Tach, four 2 1/8" gauge (Fuel 0-90 OHM)

110020

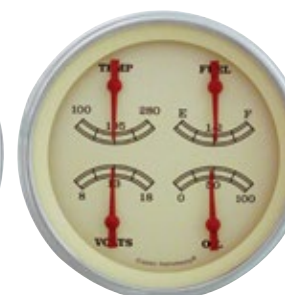
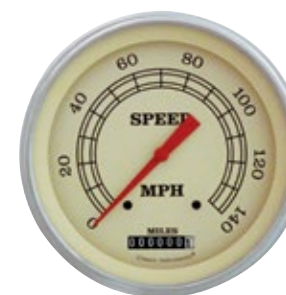

1947-53 Chevy & GMC

VINTAGE STYLE GAUGE PACKAGE

- 5" Speed/Quad (Fuel 240-330hm)

110017



1954-55 Chevy & GMC

TRADITIONAL STYLE GAUGE PACKAGE

- 5" Speed/Tach/Quad (Fuel 240-330hm)

110018

DASH KNOBS



1947-54 Chevy & GMC Truck HEADLIGHT ROD & KNOBS

• Exact design as original

- C475321 | 1947-53 | Maroon
- C545521 | 1954-55 | Black
- C555921 | 1955-59 | Chrome
- C606321 | 1960-63 | Black
- C646621 | 1964-66 | Black



1947-66 Chevy & GMC Truck WIPER SWITCH KNOBS

• Original wiper switch design made of durable plastic with high quality chrome plating

- C475309C | 1947-53 | Chrome
- C475309M | 1947-53 | Maroon
- C555931 | 1955-59 | Chrome
- C606331 | 1960-63 | Black/Stainless Steel
- C646631 | 1964-66 | Black/Stainless Steel



1968-72 Chevy & GMC Truck WIPER SWITCH KNOBS

- High quality plastic injection molded with durable polypropylene plastic
 - Deluxe style with stainless steel center insert
 - Original style "D" profile mounting hole, set screw included
- 110700**



1968-72 Chevy & GMC Truck WIPER SWITCH KNOBS

- High quality plastic injection molded with durable polypropylene plastic
 - Deluxe style with stainless steel center insert
 - Original style "D" profile mounting hole, set screw included
- 110701**

KNOBS / CABLES / ETC.



1947-59 Chevy & GMC

CHOKE CABLE AND KNOB

• Stainless steel cable

- C475302 | 1947-53 | Stainless Steel w/ Maroon Knob
- C555905 | 1955-59 | Stainless Steel w/ Chrome Knob

1947-59 Chevy & GMC

THROTTLE CABLE AND KNOB

• Stainless steel cable

- C475301 | 1947-53 | Stainless Steel w/ Maroon Knob
- C555904 | 1955-59 | Stainless Steel w/ Chrome Knob



1947-72 Chevy & GMC SPEEDOMETER CABLE

- 68" speedometer cable
- C477203**



SWITCHES / FLASHER



Universal

CHROME TURN SIGNAL SWITCH

- 7 wire system, comes with adjustable clamp to hold onto the steering column, no drilling required
 - Indicator light at the end of the turn signal handle
 - Inline fuse and wiring diagram included, ready to use for 12V systems, also works for 6V if indicator bulb is changed to 6V
- A5007**



Universal

HEAVY DUTY TURN SIGNAL SWITCH

- All metal chrome plated heavy duty switch with 7 wires
 - Clamp onto hold steering column
 - Turn signal indicator lights, 4-way emergency hazard function with red light
 - Includes in-line fuse and wiring diagram
 - Ready to use for 12 volt systems, also works for 6 volt if indicator bulb is changed to 6 volt
- 5007R**



Universal

TURN SIGNAL SWITCH W/ 4 WAY HAZARD

- Chrome plated housing, clamps onto steering wheel
 - 4 way hazard switch
 - Lighted direction indicators
- 110307**

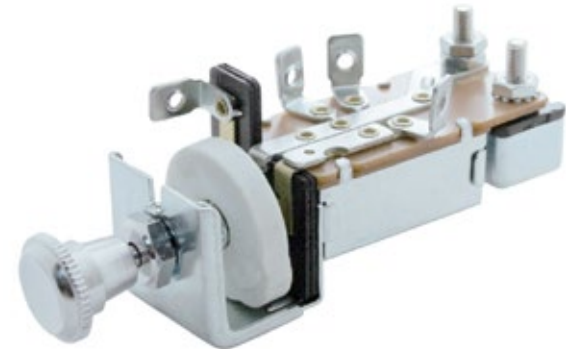

1947-59 Chevy & GMC Truck

HEADLIGHT SWITCH

- C475502 | 1947-55 | 6 Volt, 1st Series**
- C475901 | 1947-59 | 12 Volt**



Universal

6 VOLT TURN SIGNAL FLASHER

- For all 6 volt positive and negative ground applications
 - 3 terminal, 535 type
 - Has "P" terminal for single dash indicator light
 - Use with turn signal switches 5007R or A5007 on 6 volt vehicles
 - Must use load resistor PN 34205 (need 2) when used with 6 volt LED lights
- 110252**



Universal

IGNITION SWITCH W/ TWO KEYS

- Universal, 4 positions (ACC, OFF, IGN/ACC, IGN/START)
 - Knurled aluminum mounting nut, mounts in 3/4" hole
 - Stud terminal posts with nuts
- S1204**

SWITCHES / SHIFT KNOBS



Universal

BATTERY DISCONNECT SWITCH

- Prevents dead batteries, theft, and provides a safer work environment with the battery disconnected
 - Heavy duty metal housing with die-cast knob
- S1201 | 250A Continuous, 450A Momentary**
S1202 | 350A Continuous, 500A Momentary



Universal

CHROME T-SHIFT KNOB

- Custom chrome t-shift knob, perfect for vintage Chevy, Ford, and Mopar
 - 5/16 - 24 thread adapter
- 110289**



Universal

CHROME DAGGER SHIFT KNOB

- High quality chrome finish with machined grip
 - Universal hex screw mount, includes mounting hardware
- 70677 | Dagger**
70679 | Skull



Universal

DAGGER AIR VALVE KNOB

- Works as a dipstick handle with adapter removed
 - Universal hex screw mount, includes mounting hardware
- 23529 | Black**
23525 | Chrome

STEERING COLUMNS BY



1960-66 Chevy & GMC

MILL FINISH STEERING WHEEL COLUMN

- Design to fit the original dash mount
- Accepts the original rag joint flange or factory steering shaft
- The classic applications use our 2" diameter column to match the existing mounting holes
- Polished stainless steel

110052



1960-66 Chevy & GMC

TILT STEERING WHEEL COLUMN

- Design to fit the original dash mount
- Accepts the original rag joint flange or factory steering shaft
- The classic applications use our 2" diameter column to match the existing mounting holes
- Polished stainless steel

110050



1960-66 Chevy & GMC

MILL FINISH STEERING WHEEL COLUMN

- Mill finish steering column with late power steering
- Designed to fit the original dash mount
- Accepts the original rag joint flange or factory steering shaft
- The classic applications use our 2" diameter column to match the existing mounting holes

110051



1960-66 Chevy & GMC

MILL FINISH STEERING WHEEL COLUMN

- Design to fit the original dash mount
- Accepts the original rag joint flange or factory steering shaft
- The classic applications use our 2" diameter column to match the existing mounting holes

110049



1960-66 Chevy & GMC Truck

FLOOR SHIFT TILT COLUMN

- Use with late model power steering box
- Tilt column includes slip shaft and correct universal joint
- Polished stainless steel

110264



1967-72 Chevy & GMC Truck

30" TILT & SHIFT STEERING COLUMN

- GM 30" tilt column shift steering column with ignition key lock
- Ignition key switch is on the column, 2 keys included
- 30" Long, 3/4", 36 spline shaft accepts most GM original rag joint coupler flange
- 2" diameter column includes GM style ignition switch and turn signal switch, paintable mill finish stainless steel

110317

COLUMN / HUB ADAPTER / HORN



Early GM Models

30" MILL FINISH STEERING WHEEL COLUMN

- 30" column shift tilt column with neutral safety switch
- Complete with gearshift knob, billet dress up kit (tilt, turn signal levers and hazard knob)
- Illuminated gearshift indicator and GM wiring (4-14" connector) and removable 12-position linkage arm

110403



Universal

HORN BUTTON

- Satin finish with black button
- Two screw electrical terminals, mounting screws included

40028



1949-80 GMC

STEERING WHEEL HUB ADAPTER KIT

- Use with 3-bolt mount steering wheels
- Fits wide variety of GM vehicles 1949-80
- Includes splined hub, horn contact plate and hardware
- Horn button cap sold separately

110314



1967-72 Chevy Truck

CHROME HORN BUTTON CAP W/ BOWTIE

- Chrome horn button with bowtie logo

C677251



1967-68 Chevy Truck

CHROME HORN BUTTON CAP

- Chrome horn button cap with Chevrolet division markings

C676851

STEERING WHEELS



STEERING WHEELS



Universal

15" WOODGRAIN STEERING WHEEL

- 15" woodgrain steering wheel for 3-bolt hubs
- Wood grip with finger grooves and aluminum rivets
- 304 stainless steel spokes, dish depth 4"
- Compatible with all 3-bolt steering wheel hub kits on the market
- Hub adapter and horn button kit sold separately

110794



Universal

14" CHROME 3-SPOKE STEERING WHEEL

- 14" chrome aluminum 3-spoke style 9-screw mount steering wheel
- Comfortable black leather grip
- Requires standard 9-screw steering wheel hub adapter and horn button kit, sold separately

88300



Universal

14" CHROME 3-SPOKE STEERING WHEEL

- 14" chrome aluminum steering wheel
- Comfortable black leather grip
- Requires standard 9-screw steering wheel hub adapter and horn button kit, sold separately

88301



Universal

14" CHROME BLADE STEERING WHEEL

- 14" chrome aluminum blade style steering wheel
- Comfortable black leather grip
- Requires standard 9-screw steering wheel hub adapter and horn button kit, sold separately

88302



Universal

14" CHROME SCORPION STEERING WHEEL

- 14" chrome aluminum scorpion style steering wheel
- Comfortable black leather grip
- Requires standard 9-screw steering wheel hub adapter and horn button kit, sold separately

88304

GLOVE BOX / BRAKE COVER / ETC.



1955-59 Chevy & GMC Truck 2nd Series

GLOVE BOX DOOR KIT

- High quality 22 gauge steel sheet metal
- Heavy gauge arm brackets with 10-32 tapped holes
- 10-24 caged nuts for quick hinge mounting
- 10-32 & 10-24 screws included

110338



1960-66 Chevy & GMC Truck

GLOVE BOX HINGE BUSHING

- OD 0622", ID 0275", Thickness 0298"

110402



1967-68 Chevy & GMC Truck

CHROME HAND BRAKE COVER

- Original accessory fits below steering column to dress up the hand brake
 - Stamped steel like the original and beautifully chrome plated
- C676802



1947-55 Chevy 1st Series Truck

PEDAL PAD

- Identical size and shape as original
- C7018



1967-72 Chevy Truck

BRAKE & CLUTCH PEDAL PAD & TRIM

- Rubber pad and stainless trim sold separately

C677210 | Rubber pad

C677211 | Stainless trim

A/C VENTS / DEFROST DUCTS



1967-72 Chevy & GMC Truck

A/C CENTER VENT

- High quality die-cast zinc and chrome plated
 - Mounting hardware not included
- 110582



1967-72 Chevy & GMC Truck

DEFROSTER DUCTS

- Injection molded plastic same as the original

C677215 | LH/Driver | Black

C677216 | RH/Passenger | Black

C677217 | LH/Driver | Chrome

C677218 | RH/Passenger | Chrome



1967-72 Chevy & GMC Truck

A/C VENT BALL

- High quality die-cast zinc and chrome plated
 - Sold individually, fits LH/Driver or RH/Passenger
- C677214



VENT WINDOWS



1951-55 Chevy & GMC Truck

VENT WINDOW ASSEMBLY

- Complete assembled vent window, includes glass, chrome vent frame, chrome vent handles, rubber vent seal, division bar with felt, and brackets

- Sold individually, please specify LH/Driver or RH/Passenger

120511 | LH/Driver | No Tint

120512 | RH/Passenger | No Tint

120513 | LH/Driver | Tinted

120514 | RH/Passenger | Tinted

VENT FRAME / GLASS CHANNEL



1951-55 Chevy & GMC Truck

CHROME VENT WINDOW FRAME

- Beautiful show ready triple chrome plated finish
- Mounting stud with threaded end for easy installation
- Sold in pairs

122511

1960-63 Chevy & GMC Truck

CHROME VENT WINDOW FRAME

- Beautiful show ready triple chrome plated finish
- Mounting stud with threaded end for easy installation
- Sold in pairs

122601



1951-55 Chevy & GMC Truck

VENT WINDOW ASSEMBLY

- Complete assembled vent window, includes glass, chrome vent frame, chrome vent handles, rubber vent seal, division bar with felt, and brackets

- Sold individually, please specify LH/Driver or RH/Passenger

120641 | LH/Driver | No Tint

120642 | RH/Passenger | No Tint

120643 | LH/Driver | Tinted

120644 | RH/Passenger | Tinted



1967-72 Chevy & GMC Truck

VENT WINDOW ASSEMBLY

- Complete assembled vent window, includes glass, chrome vent frame, chrome vent handles, rubber vent seal, division bar with felt, and brackets

- Sold individually, please specify LH/Driver or RH/Passenger

120671 | LH/Driver | No Tint

120672 | RH/Passenger | No Tint

120673 | LH/Driver | Tinted

120674 | RH/Passenger | Tinted



1964-66 Chevy & GMC Truck

CHROME VENT WINDOW FRAME

- Beautiful show ready triple chrome plated finish
- Mounting stud with threaded end for easy installation
- Sold in pairs

122641

1967-72 Chevy & GMC Truck

CHROME VENT WINDOW FRAME

- Beautiful show ready triple chrome plated finish
- Mounting stud with threaded end for easy installation
- Sold in pairs

122671

1967-72 Chevy & GMC Truck

LOWER GLASS CHANNEL

- High tensile strength steel like the original
- Sold individually, please specify LH/Driver or RH/Passenger

110244 | LH/Driver

110245 | RH/Passenger



OUTSIDE DOOR HANDLES



1947-51 Chevy & GMC Truck

OUTSIDE CHROME DOOR HANDLE SET

- Die-cast and chrome plated
- Pads and mounting screws included
- Sold in pairs

C475001



1960-66 Chevy & GMC Truck

OUTSIDE CHROME DOOR HANDLE SET

- Die-cast and chrome plated
- RH/Passenger handle includes push button, LH/Driver requires locking push button, sold separately
- Pads and mounting screws included
- Sold in pairs

110313



1952-59 Chevy & GMC Truck

OUTSIDE CHROME DOOR HANDLE SET

- Die-cast and chrome plated
- RH/Passenger handle includes push button, LH/Driver requires locking push button, sold separately
- Pads and mounting screws included
- Sold in pairs

110312



1967-72 Chevy & GMC Truck

OUTSIDE CHROME DOOR HANDLE SET

- Die-cast and chrome plated
- Pads and mounting screws included
- Sold in pairs

115670

INSIDE DOOR / WINDOW HANDLES



1947-66 Chevy Truck

INSIDE DOOR HANDLE

- Die-cast and chrome plated
- Sold individually

C476601



1967-72 Chevy Truck

DOOR HANDLE CLIP REMOVER TOOL

- Zinc plated stamped steel
- Removes inside door handle clips

C496404



1967-72 Chevy Truck

INSIDE WINDOW CRANK HANDLE

- Die-cast and chrome plated with black knob
- Sold individually

C677601



1967-90 Chevy Truck

INSIDE WINDOW CRANK HANDLE

- Die-cast and chrome plated with clear knob
- Sold individually

C678101



1967-72 Chevy Truck

INSIDE DOOR HANDLE

- Die-cast and chrome plated
- Sold individually

C677602



1947-66 Chevy & GMC Truck

INSIDE WINDOW CRANK HANDLE

- Die-cast and chrome plated with black knob
- Sold individually

C476602



Universal

BILLET ALUMINUM WINDOW CRANK HANDLE

- Classic aircraft style brushed aluminum finish
- Universal application, 3 adapters included (circular, splined & square)
- Includes stainless steel set screws & hex wrench

24039



Universal

BILLET ALUMINUM WINDOW CRANK HANDLE

- Classic aircraft style brushed aluminum finish
- Universal application, 3 adapters included (circular, splined & square)
- Includes stainless steel set screws & hex wrench

24009

WINDOW REGULATORS



116471



116512



116472



116552



116511



116602



116551



116642



116601



116672



116641



1947-71 Chevy & GMC Truck

WINDOW REGULATORS

- Durable steel stamping, counter balance spring included
- Zinc plated or painted black for corrosion protection
- Sold individually

- 116471 | 1947-50 | LH/Driver
- 116472 | 1947-50 | RH/Passenger
- 116511 | 1951-55 | LH/Driver
- 116512 | 1951-55 | RH/Passenger
- 116551 | 1955-59 | LH/Driver
- 116552 | 1955-59 | RH/Passenger
- 116601 | 1960-63 | LH/Driver
- 116602 | 1960-63 | RH/Passenger
- 116641 | 1964-66 | LH/Driver
- 116642 | 1964-66 | RH/Passenger
- 116671 | 1967-71 | LH/Driver
- 116672 | 1967-71 | RH/Passenger

DOOR SILL / DOOR LATCH RELAY



1967-72 Chevy & GMC Truck

CHROME DOOR SILL PLATE

- Fits LH/Driver or RH/Passenger
 - Sold individually
- C677201**



1947-55 Chevy & GMC 1st Series Truck

INSIDE DOOR LATCH RELAY

- Zinc plated steel
 - Sold individually, please specify driver or RH/Passenger
- 110162 | RH/Passenger**
110163 | LH/Driver



1960-63 Chevy & GMC Truck

INSIDE DOOR LATCH RELAY

- Zinc plated steel
 - Sold in pairs
- 110164**
110165



1947-55 Chevy & GMC 1st Series Truck

INSIDE DOOR LATCH RELAY

- Zinc plated steel
 - Sold individually, please specify driver or RH/Passenger
- C555902 | RH/Passenger**
C555903 | LH/Driver

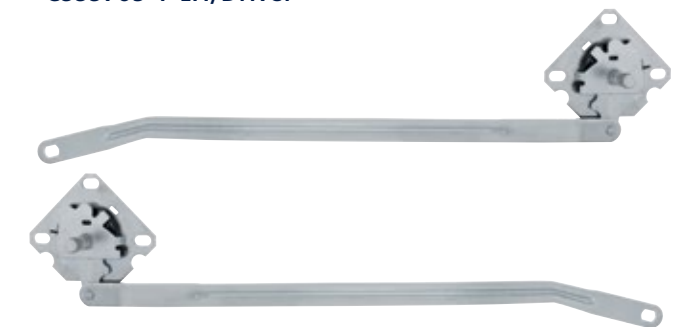

1964-66 Chevy & GMC Truck

INSIDE DOOR LATCH RELAY

- Zinc plated steel
 - Sold in pairs
- 110166 | RH/Passenger**
110167 | LH/Driver



1967-71 Chevy & GMC Truck

DOOR LATCH WITH REMOTE CONTROL RODS

- Zinc plated steel
 - Sold individually, please specify driver or RH/Passenger
- 110246 | RH/Passenger**
110247 | LH/Driver

DOOR LATCHES / STRIKER PLATES

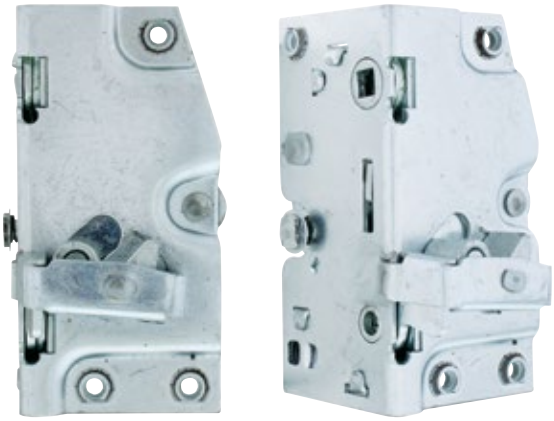

1947-51 Chevy & GMC Truck

DOOR LATCH

- Zinc plated, precision stamping with original design mechanism
- Mounting hardware not included
- Sold individually

110186 | RH/Passenger

110187 | LH/Driver



1947-51 Chevy & GMC Truck

DOOR LATCH STRIKER PLATE

- Zinc plated, excellent reproduction of the original
- Mounting hardware not included
- Sold in pairs

110192



1952-55 Chevy & GMC Truck

DOOR LATCH

- Zinc plated, precision stamping with original design mechanism
- Mounting hardware not included
- Sold individually

110188 | RH/Passenger

110189 | LH/Driver



1960-63 Chevy & GMC Truck

DOOR LATCH

- Zinc plated, precision stamping with original design mechanism
- Mounting hardware not included
- Sold individually

110258 | RH/Passenger

110259 | LH/Driver

DOOR LATCHES / STRIKER PLATES



1955-59 Chevy & GMC 2nd Series Truck

DOOR LATCH

- Zinc plated, precision stamping with original design mechanism
- Mounting hardware not included
- Sold individually

110190 | RH/Passenger

110191 | LH/Driver



1952-59 Chevy & GMC Truck

DOOR LATCH STRIKER PLATE

- Zinc plated, excellent reproduction of the original
- Mounting hardware not included
- Sold in pairs

110193

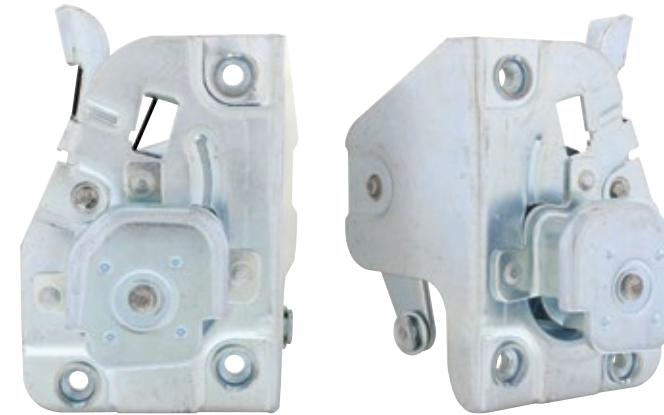

1964-66 Chevy & GMC Truck

DOOR LATCH

- Zinc plated, excellent reproduction of the original
- Mounting hardware not included
- Sold in pairs

110260 | RH/Passenger

110261 | LH/Driver

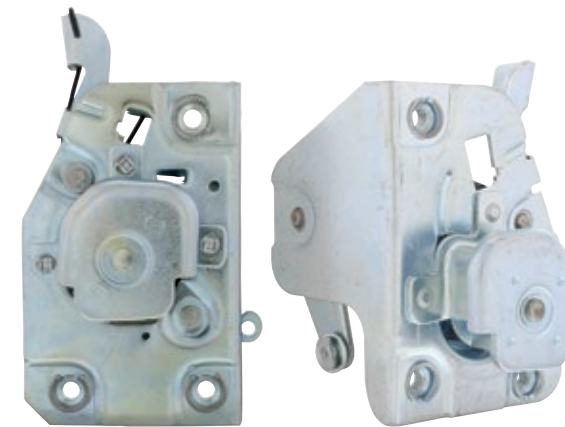

1967-72 Chevy & GMC

DOOR LATCH

- Zinc plated, precision stamping with original design mechanism
- Mounting hardware not included
- Sold individually

110262 | RH/Passenger

110263 | LH/Driver



1967-72 Chevy & GMC

DOOR LATCH STRIKER PLATE

- Zinc plated, excellent reproduction of the original
- Mounting hardware not included
- Sold in pairs

110223

RUNNING BOARDS / BEDSIDE STEPS

1947-54 Chevy & GMC Shortbed Truck

RUNNING BOARDS

- Black painted steel running boards
- Sold individually, please specify LH or RH side

170471 | LH/Driver

170472 | RH/Passenger



1947-54 Chevy & GMC Shortbed Truck

RUNNING BOARDS

- Chrome plated steel running boards
- Sold individually, please specify LH or RH side

170473 | LH/Driver

170474 | RH/Passenger



1955-59 Chevy & GMC Truck

SHORTBED BEDSIDE STEP

- Black painted steel running boards
- Sold individually, please specify LH or RH side

170551 | LH/Driver

170552 | RH/Passenger



1955-59 Chevy & GMC Truck

Longbed Bedside Step

- Black painted steel running boards for trucks with 7 1/2 foot bed
- Sold individually, please specify LH or RH side

170553 | LH/Driver

170554 | RH/Passenger



HANGERS / HARDWARE

1960-66 Chevy & GMC Truck

BEDSIDE STEP HANGERS

- Die stamped with heavy 14 gauge steel, black EDP coated
- Features all the original frame to step mounting patterns
- Sold individually, please specify LH or RH side

110400 | RH/Passenger

110401 | LH/Driver



1967-72 Chevy Truck

CAB MOUNT KIT

- Quality molded rubber cab mounts
- 38 piece kit
- Includes all mounting bolts, lock nuts, spacers and larger washers

C677204

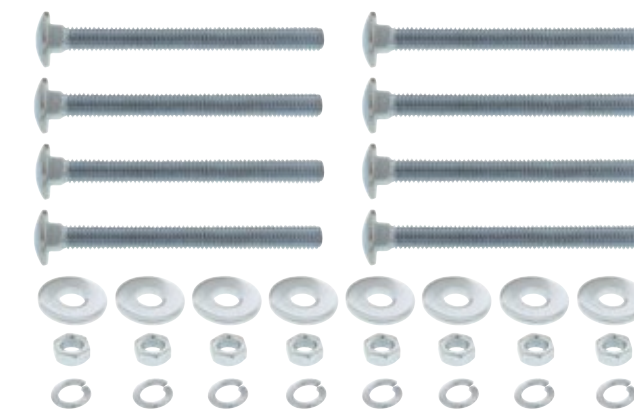

1967-72 Chevy & GMC Truck

PICKUP BED TO FRAME BOLT SET

- Special carriage bolts that mount the pickup bed to the frame
- Includes flat washers, lock washers, and hex nuts
- Zinc plated as original, sold as a set

110248



1941-53 Chevy & GMC Stepside Truck

TAILGATE HINGES

- Sold in pairs

C415301 | Black

C415301C | Chrome

GAS CAPS



1938-71 GM Passenger Car and Truck

VENTED LOCKING GAS CAP

- High quality chrome plated gas cap
 - Fits most early GM gas necks with 1.53" opening
 - Integrated lock, two keys included
 - For use only on vehicles originally equipped with vented gas cap
- 110319**



1938-71 GM Passenger Car and Truck

GM LOCKING GAS CAP

- High quality chrome plated gas cap
 - Fits most early GM gas necks with 1.53" opening
 - Integrated lock, two keys included
 - For use only on vehicles originally equipped with vented gas cap
- 110318**



1947-71 Chevy & GMC Truck

CHROME LOCKING GAS CAP

- High quality chrome plated, vented gas cap
 - Also fits 1958-63 Chevy car
 - Integrated lock, two keys included
- S1301**



FUEL TANKS



1949-55 Chevy & GMC 1st Series Truck

18 GALLON TIN SHEET FUEL TANK

- Die stamped with Ni-Terne treated steel sheet metal
 - Has all the original contour detail and mounting holes
 - Machine welded for an even and complete seal
- 110687**



1955-59 Chevy & GMC 2nd Series Truck

18 GALLON TIN SHEET FUEL TANK

- Die stamped with Ni-Terne treated steel sheet metal
 - Has all the original contour detail and mounting holes
 - Machine welded for an even and complete seal
- 110688**



1967-72 Chevy & GMC C/K Series Truck

20 GALLON TIN SHEET FUEL TANK W/O EVAP

- Die stamped with Ni-Terne treated steel sheet metal
 - Has all the original contour detail and mounting holes
 - Machine welded for an even and complete seal
 - For models without evap
- 110685**



1970-72 Chevy & GMC C/K Series Truck

20 GALLON TIN SHEET FUEL TANK W/ EVAP

- Die stamped with Ni-Terne treated steel sheet metal
 - Has all the original contour detail and mounting holes
 - Machine welded for an even and complete seal
 - For models with evap
- 110686**



1973-81 Chevy & GMC C/K Series Truck

16 GALLON STEEL ZINC PLATED FUEL TANK

- Die stamped with Ni-Terne treated steel sheet metal
 - Has all the original contour detail and mounting holes
 - Machine welded for an even and complete seal
- 110683**



1982-86 Chevy & GMC Shortbed Truck

16 GALLON STEEL ZINC PLATED FUEL TANK

- Die stamped with Ni-Terne treated steel sheet metal
 - Has all the original contour detail and mounting holes
 - Machine welded for an even and complete seal
 - Sending unit available separately, item number: 110675, 110671, and 110673
- 110684**

FUEL SENDING UNITS



1973-75 Chevy & GMC Truck

FUEL SENDING UNIT TANK - RH

- Made with corrosion resistant stainless steel sheet metal
 - Features a single outlet only design with brass float just like the original
 - Rubber seal, stainless steel lock ring, and strainer included
- 110676**



1973-79 Chevy & GMC 6 Cylinder Truck

FUEL SENDING UNIT TANK - RH

- Made with corrosion resistant stainless steel sheet metal
 - Features a single outlet only design with brass float just like the original
 - Rubber seal, stainless steel lock ring, and strainer included
- 110672**

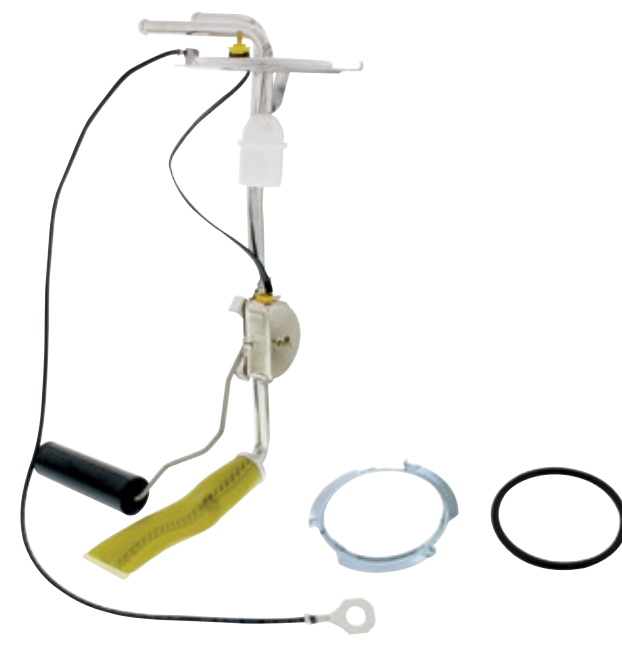

1973-79 Chevy & GMC Truck

FUEL SENDING UNIT TANK - LH

- Made with corrosion resistant stainless steel sheet metal
 - Features a 2 outlet design with brass float just like the original
 - Rubber seal, stainless steel lock ring, and strainer included
- 110674**



1973-79 Chevy & GMC Truck

FUEL SENDING UNIT TANK - RH

- Made with corrosion resistant stainless steel sheet metal
 - Features a 2 outlet design with brass float just like the original
 - Rubber seal, stainless steel lock ring, and strainer included
- 110670**



1980-84 Chevy & GMC Truck

FUEL SENDING UNIT TANK - LH

- Made with corrosion resistant stainless steel sheet metal
 - Features a 2 outlet design with brass float just like the original
 - Rubber seal, stainless steel lock ring, and strainer included
- 110673**



1980-89 Chevy & GMC Truck

FUEL SENDING UNIT TANK - RH

- Made with corrosion resistant stainless steel sheet metal
 - Features a 3 outlet design with brass float just like the original
 - Rubber seal, stainless steel lock ring, and strainer included
- 110671**

FUEL SENDING UNITS



1980-89 Chevy & GMC Truck

FUEL SENDING UNIT TANK - LH

- Made with corrosion resistant stainless steel sheet metal
 - Features a 3 outlet design with brass float just like the original
 - Rubber seal, stainless steel lock ring, and strainer included
- 110675**

EMBLEM

CHEVROLET

1967-68 Chevy & GMC Truck

CHROME HOOD LETTER EMBLEM SET

- Beautiful chrome plated die-cast
- Identical mounting stud location as original for easy replacement
- Speed nuts included
- OEM GM # 3892085, GM restoration licensed product

110057



HUB CAPS / EXHAUST DEFLECTORS



1947-53 Chevy 1/2 Ton Truck

CHROME HUBCAP

- Chrome hub cap with red Chevrolet script
- GM restoration parts, sold individually

C475303 | Stainless Steel

C475304 | Chrome



1968-70 Chevy Truck & Car

SS BULLET CENTER STYLE RALLY HUB CAP

- Set of 4 highly polished stainless steel
- Fits original rally wheels and aftermarket rally wheels

C687003



Universal

SMOOTH STAINLESS STEEL BEAUTY RIM

- Highly polished stainless steel, smooth plain style
- Round notch for valve stem clearance, sold individually

A6224-3 | 14" Beauty Rim

A6224-1 | 15" Beauty Rim

A6224-2 | 16" Beauty Rim



Universal

RIBBED STAINLESS STEEL BEAUTY RIM

- Highly polished stainless steel, smooth plain style
- Round notch for valve stem clearance, sold individually

A6224-4 | 14" Beauty Rim

A6224-5 | 15" Beauty Rim

A6224-6 | 16" Beauty Rim



Chevy & GMC Truck

EXHAUST DEFLECTOR

- 304 high grade stainless steel, rust free
- Fits most exhaust pipes, GM restoration parts

C2002 | With "Chevrolet" Script Bowtie

C2003 | With Bowtie



LICENSE PLATE FRAMES



1947-60 Chevy

CHROME LICENSE PLATE FRAMES

- Chrome zinc die-cast frame with white script and year on dark blue background
- GM restoration parts

C5041-47 1947	C5041-54 1954
C5041-48 1948	C5041-55 1955
C5041-49 1949	C5041-56 1956
C5041-50 1950	C5041-57 1957
C5041-52 1952	C5041-59 1959
C5041-53 1953	C5041-60 1960

LICENSE PLATE FRAMES



1962-72 Chevy

CHROME LICENSE PLATE FRAMES

- Chrome zinc die-cast frame with white script and year on dark blue background
- GM restoration parts

C5041-62 1962	C5041-68 1968
C5041-63 1963	C5041-69 1969
C5041-65 1965	C5041-70 1970
C5041-66 1966	C5041-71 1971
C5041-67 1967	C5041-72 1972

HORNS



Universal

ECONOMY TRAIN HORN

- Economy 3 & 4 trumpet air horns
- 46127 | Black 3 Trumpet
- 46129 | Chrome 3 Trumpet
- 46130 | Chrome 4 Trumpet



Universal

TRAIN WHISTLE

- Simulates the sound of a vintage train whistle
- Mounting hardware and 1/2" compression fitting included
- Powered by compressed air or live steam
- Operating range from 30 PSI to 120 PSI and up
- 5 1/2" L x 5" W x 13 1/8" H
- 46107 | Chrome
- 46108 | Brass



Universal

CHROME MINI TRAIN HORN

- Deluxe chrome 4 trumpet mini train horn
- Easy installation, approximate size: 6 1/2" x 12" x 6"
- 46123

Universal

CHROME DELUXE 4 TRUMPET TRAIN HORN

- Low rider style
- 150 + -10db sound output
- Width 15 3/4", length 15 1/4", height 9 3/4"
- 46143

HORNS / AIR COMPRESSOR



Universal

HIGH POWER DIXIE AIR HORN

- Air horn that imitates the howl of a wolf
- Hardware included
- 46153



Universal

RED ELECTRIC BULL HORN

- Air horn that imitates the sound of an angry bull
- Painted red housing, 12V systems
- 46103



Universal

ELECTRIC AH-OO-GAH HORN

- Chrome body, 12V systems
- -110 dB (A) sound pressure level, 490 Hz frequency
- 46138



Universal

WOLF SOUND HORN

- Air horn that imitates the howl of a wolf
- Hardware included
- 46128



Universal

TURBO COMPRESSOR AND TANK KIT

- Heavy duty compressor and tank system for high pressure air/train horns
- High volume turbo compressor with 5.5 liter extended tank
- On-board air system for all 12 volt vehicles
- 46140

PRODUCT INDEX

ITEM #	PAGE #	ITEM #	PAGE #	ITEM #	PAGE #	ITEM #	PAGE #	ITEM #	PAGE #	ITEM #	PAGE #	ITEM #	PAGE #	ITEM #	PAGE #
10444	30	31374	23	70679	90	110191	104	110339	67	110724	64	120644	97	C4008-2	44
10445	30	31375	21	70801	81	110192	103	110340	67	110725	64	120671	97	C4009	34
10448	30	31376	21	70802	82	110193	104	110341	67	110726	64	120672	97	C4009-1	34
10449	30	31378	15	70803	81	110199	40	110342	67	110728	63	120673	97	C415301	106
10461	30	31379	15	70804	82	110200	46	110344	68	110729	63	120674	97	C415301C	106
10466	30	31386	17	88300	94	110201	46	110345	68	110730	64	122511	98	C475001	99
10467	29	31387	16	88301	94	110202	46	110358	28	110731	64	122601	98	C475301	88
10468	29	31388	24	88302	94	110213	42	110362	46	110733	64	122641	98	C475302	88
10476	30	31389	24	88304	94	110214	42	110387	66	110741	74	122671	98	C475303	112
10477	30	31390	24	105471	61	110215	45	110388	66	110742	74	170471	105	C475304	112
10532	29	31391	12	105551	61	110216	46	110389	66	110743	74	170472	105	C475307	53
21476	30	31393	16	105601	61	110217	58	110390	66	110748	73	170473	105	C475307CR	53
21477	30	31396	22	105631	61	110223	104	110400	106	110748	73	170474	105	C475308	54
23525	90	31397	22	105671	61	110243	80	110401	106	110749	72	170551	105	C475309C	87
23529	90	31458	11	105672	61	110244	98	110402	95	110750	34	170552	105	C475309M	87
24009	100	31459	12	105711	61	110245	98	110403	92	110765	35	170553	105	C475310	84
24039	100	31496	14	106471	62	110246	102	110404	38	110766	35	170554	105	C475310CR	83
30354	16	31513	13	106472	64	110247	102	110405	38	110767	35	190471	80	C475313	66
30356	16	31514	13	106542	62	110248	106	110415	32	110768	35	190472	80	C475321	87
31084	14	34122	18	106552	62	110249	68	110416	32	110770	60	190541	80	C475351	84
31087	18	34125	22	106581	62	110250	68	110419	32	110771	60	190542	80	C475501	70
31088	20	34222	25	106631	62	110252	89	110420	32	110794	94	190601	80	C475502	89
31089	20	34263	25	106671	62	110258	103	110429	27	110795	39	190602	80	C475510	78
31150	19	34264	25	106672	62	110259	103	110446	58	110807	69	190671	80	C475511	78
31151	19	36888	25	110017	86	110260	104	110470	69	110829	9	106601W	62	C475512	78
31152	19	39006	40	110018	86	110261	104	110471	69	110830	9	106601WO	62	C475513	78
31153	19	39014	40	110019	86	110262	104	110472	69	110839	10	34217B	25	C475901	89
31168	21	39043	56	110020	86	110263	104	110473	69	110845	10	39994B	59	C475902	83
31169	21	39065	58	110049	91	110264	91	110582	96	110846	10	5007R	89	C476601	100
31200	13	39132	25	110050	91	110279	67	110670	109	110847	10	A5007	89	C476602	100
31201	17	40028	92	110051	91	110280	68	110671	110	110847	10	A5023-3	16	C476901	77
31202	17	46103	116	110052	91	110281	68	110672	109	115670	99	A6224-1	112	C476902	77
31237	21	46107	115	110057	111	110282	28	110673	110	116471	101	A6224-2	112	C476903B	77
31238	21	46108	115	110110	33	110283	28	110674	109	116472	101	A6224-3	112	C476904	77
31247	15	46123	115	110111	33	110289	90	110675	110	116511	101	A6224-4	112	C477201	77
31259	17	46127	115	110114	43	110289	90	110675	110	116512	101	A6224-5	112	C477202	77
31267	17	46128	116	110115	43	110300	79	110676	109	116551	101	A6224-6	112	C477203	86
31274	22	46129	115	110127	58	110301	79	110683	108	116552	101	A6235	79	C477203	88
31275	22	46130	115	110162	102	110302	79	110684	108	116601	101	A6236	79	C477204	62
31284	15	46138	116	110163	102	110303	79	110685	108	116602	101	A7026	79	C496404	100
31285	15	46140	116	110164	102	110304	79	110686	108	116641	101	A7027	79	C5001	74
31289	12	46143	115	110165	102	110305	79	110687	108	116642	101	A7037	79	C5001-1	74
31297	18	46153	116	110166	102	110306	79	110688	108	116671	101	C2001A	30	C5001-1CVX	74
31299	20	60039	76	110167	102	110307	89	110700	87	116672	101	C2001B	30	C5001-CVXLED	74
31355	14	60050	76	110168	58	110312	99	110701	87	120511	97	C2001G	30	C5001-LED	74
31365	19	70300	59	110186	103	110313	99	110705	27	120512	97	C2001R	30	C5006	30
31368	23	70301	59	110187	103	110314	92	110718	63	120513	97	C2002	112	C5010	30
31369	23	70302	59	110188	103	110317	91	110719	63	120514	97	C2003	112	C5025	58
31372	26	70303	59	110189	103	110318	107	110720	63	120641	97	C383901	61	C5026	58
31373	23	70677	90	110190	104	110319	107	110721	63	120642	97	C4008-1	44	C5041-47	113
						110338	95	110722	63	120643	97				

PRODUCT INDEX

ITEM #	PAGE #
C5041-48	113
C5041-49	113
C5041-50	113
C5041-52	113
C5041-53	113
C5041-62	114
C5041-63	114
C5041-65	114
C5041-66	114
C5041-67	114
C515301	51
C515301	54
C515321	54
C535910CR	83
C545502BK	45
C545502CR	45
C545502SS	45
C545503BK	45
C545503CR	45
C545503SS	45
C545504-2	44
C545504BK	36
C545504SS	36
C545505	36
C545506	44
C545507	36
C545521	87
C555711	70
C555751A	51
C555751C	51
C555755	54
C555901	58
C555902	102
C555903	102
C555904	88
C555905	88
C555908	37
C555909	44
C555910	36
C555911	36
C555911-3	44
C555912	37
C555921	87
C555931	87
C555941	78
C555942	78
C555943	78
C555944	78
C556601BK	45
C556601CR	45

ITEM #	PAGE #
C556601SS	45
C556602BK	45
C556602CR	45
C556602SS	45
C585901	37
C585902	37
C585902ALU	44
C585902SS	44
C585911	70
C585981	27
C60609C	40
C606321	87
C606331	87
C606603	40
C606603	44
C606604	70
C606605	37
C606607	36
C606608	36
C606609	40
C606610	37
C606611	40
C606612	54
C606614	45
C606615	45
C606616	39
C606616BD	39
C606616C	39
C606617	40
C606618	40
C606621	52
C606651	45
C607110	84
C607111	84
C607112	84
C626601	53
C646621	87
C646631	87
C676802	95
C676811A	52
C676811C	52
C676812	54
C676851	92
C677201	102
C677203	70
C677204	106
C677207	45
C677209	42
C677210	95
C677211	95

ITEM #	PAGE #
C677212	70
C677214	96
C677215	96
C677216	96
C677217	96
C677218	96
C677251	92
C677601	100
C677602	100
C678101	100
C679101	56
C687003	112
C687202	56
C687203	56
C697020	52
C697021	52
C7001G	59
C7001L	33
C7001L-1	33
C7001R	33
C7001R-1	33
C7002R	33
C7003L	45
C7003R	45
C7004L	45
C7004R	45
C7006	38
C7006-1	38
C7007	46
C7008	38
C7008-1	38
C7009A	51
C7009C	51
C7010	51
C7011	27
C7011-KIT	27
C7012	27
C7013	27
C7014A	51
C7014C	51
C7018	95
C7019	51
C7021	59
C7026LSS	45
C7026RSS	45
C7028L	33
C7028L-1	33
C7028R	33
C7028R-1	33
C7031RL	33

PRODUCT INDEX

ITEM #	PAGE #
C7031RLBD	32
C7031RR	33
C7031RRBD	32
C7032RLBD	32
C7033RL	33
C7033RLBD	32
C7033RR	33
C7033RRBD	32
C707201	73
C707201	73
C707201-LED	72
C707202	73
C707202	73
C707202-LED	72
C717201	54
C717221	52
C738001	56
C738002	56
C738003	56
C738011	70
C738703	46
C738704	43
C738705	43
C738710	73
C738710-CVXLED	72
C738710-LED	72
CML6872A	56
CML6872R	56
CML7380A	56
CML7380R	56
CPL4753A	50
CPL4753A-AS	50
CPL4753C	50
CPL4753C-AS	50
CPL5153C	50
CPL5557A	50
CPL5557C	50
CPL6066A	48
CPL6768A	48
CPL6768C	48
CPL6970AL	49
CPL6970AR	49
CPL6970CL	49
CPL6970CR	49
CPL7172A	48
CPL7172C	48
CTL4053LED-CL	34
CTL4053LED-CR	34
CTL4053LED-L	34
CTL4053LED-LBD	34

ITEM #	PAGE #
CTL4053LED-R	34
CTL4053LED-RBD	34
CTL4053LL	59
CTL5459BC	35
CTL5459BR	35
CTL5459C	37
CTL5459LED	37
CTL5459SC	35
CTL5459SR	35
CTL5859C	37
CTL5859LED	37
CTL6066BC	36
CTL6066BR	36
CTL6066C	37
CTL6066FC	40
CTL6066FSC	39
CTL6066FSLED	40
CTL6066FSR	39
CTL6066LED	37
CTL6066SC	36
CTL6066SR	36
CTL6721C	41
CTL6721LED	41
CTL6721SEQ	41
CTL6722CL	38
CTL6772C	38
CTL6772LED	38
CTL7387LED-L	43
CTL7387LED-R	43
H5006	17
M1003	81
S1201	90
S1202	90
S1204	89
S1301	107



United Pacific

ANTIQUE

2019 *New Product Collection*





QUALITY

With over 30 years of experience in the automotive aftermarket industry, United Pacific Industries understands the rigors and stresses that our products are subjected to on the road. It is our mission to provide our customers with products of superior quality and reliability. In achieving this goal, United Pacific only partners with manufacturing facilities that conforms to our quality control requirements and standards. Our manufacturing partners meet or exceed ISO-9001 requirements. In addition, United Pacific's manufacturing partners must be equipped on site to perform the following quality assurance tests and maintain a track record of consistent quality and low product failure rate.

- Aging Test
- Air Tight Test
- Dust Test
- Flux Test
- Photometric Test
- Pull Force Test
- Rain Test
- Salt Spray Test
- Shock Test
- Temperature Test
- Humidity Test
- Vibration Test

Furthermore, our internal quality control structure allows us to function as the final quality control station prior to shipping. With the assistance of 3D computer technology, United Pacific can adhere to strict quality control standards during prototype creation and the production process. Our engineers and technicians perform a battery of tests to ensure that our products meet the demands of today's drivers and our goal to be first in quality.

INNOVATION

Known as the leader in innovation, United Pacific is dedicated to be the first to bring new and exciting products to the market. United Pacific's global expertise allows us to search the globe for new ideas and concepts. Not only do we search the globe for new products, United Pacific invest a significant amount of resources into our own research and development efforts. With the assistance of advance 3D scanning technology, our engineers and designers can acquire accurate and precise data in seconds. The 3D data allows United Pacific to verify designs, perform quality assurance tests, and reverse engineer with unprecedented speed and accuracy. Digital inspection contributes to the early detection of shape problems, provides rapid feedback on design, and eliminates unnecessary work in downstream processes. Our rapid prototyping facility permits us to have a concept-to-shelf time of less than 5 months. In addition, United Pacific's 3D printing capabilities permit our designers to have physical models of their design concepts in hours. The physical models allow our designers and marketing staff to evaluate and test the viability of different design ideas. Our rapid prototyping facility allow United Pacific to compress design cycles, improve manufacturing planning, shorten concept-to-shelf time, most importantly, generate new and innovative products.

DESIGN

Located near some of the nation's most progressive automotive design centers, United Pacific established the UP Design Studio in 2002 to consolidate our position as the design leader in the automotive industry. UP Design Studio utilizes the latest generation of computer aided design (CAD) and studio/graphic software. The design studio is equipped with the newest computers and rapid prototyping systems. In addition, UP Design Studio is staffed by graduates from the nation's most prestigious design colleges. Unlike our competitors, United Pacific's design and manufacturing capabilities mean that we carry more new and original items than our competitors. The establishment of the design studio will enable us to generate even more new products with significant shorter concept-to-shelf time. The reduction in development cost mean that we can develop products utilizing design based development processes. Design based product development allows United Pacific to create new product concepts based on designs incorporating driver demands and needs instead of economic considerations. United Pacific's emphasis on design distinguishes and positions us ahead of our competitors.



WARRANTY

With LED (Light Emitting Diodes) rated at 100,000 hours of operation and solid-state construction, United Pacific's LED lights are extremely reliable and durable. Purchase with confidence, United Pacific offers a complete line of LED lighting products with extended or limited lifetime warranties. Please see the warranty policy page for more details.

INVENTORY AND SHIPPING

United Pacific carries over 20,000 items in our California distribution center. No other company in the heavy duty trucking industry can match United Pacific in the variety and range of in-stock inventories. With an order fill rate of over 98.5%, United Pacific is the largest and most reliable supplier in the industry. Our shipping department ships 96.8% of all orders within 24 hours and 98.9% within 48 hours. United Pacific's vast inventory and prompt shipping has made United Pacific the only source for our customer's chrome and lighting needs.



HARD AT WORK FOR THE ENVIRONMENT



United Pacific
132,000 sq ft
Distribution Center
Long Beach, CA

100% reduction in potable water used for landscaping
40% reduction in total energy use due to high-efficiency mechanical and lighting systems
82% of construction waste was diverted from landfills

LEED ACCOMPLISHMENTS

Sustainable Sites

- On-site bicycle storage, showers and changing areas for company employees.
- Preferred parking for low-emitting, fuel-efficient and carpool vehicles.
- Stormwater is infiltrated on-site and treated to remove contaminants to reduce environmental impact on local waterways.

Water Efficiency

- In addition to using reclaimed water, drought-tolerant plants and a high-efficiency irrigation system were installed to reduce the use of potable water for irrigation by 100%.

Energy and Atmosphere

- Efficient HVAC equipment and a lighting system with daylight controls reduces energy consumption by over 30%.
- Enhanced commission verifies that the building's energy and water-related systems are performing as intended by the initial design.

Indoor Environmental Quality

- Building ventilation systems was designed to provide enhanced levels of fresh outside air to building occupants.
- Interior finishes (plants, sealants, adhesives, coatings, carpet systems and composite wood) were selected with low levels of volatile organic compounds (VOCs) to reduce indoor air contamination.



NEW ITEMS

Parts & Accessories for Ford, Chevy Truck & Mustang

For 1932-34 Ford

January 2019



Front Fender for 1933-34 Ford Passenger Car

- Quality stamped steel, exactly as original Henry!
- Made of excellent 20 gauge sheetmetal
- Fender edge bead with steel inner wire as original
- Precision punched quarter panel mounting holes
- Includes mounting holes for frame horn cover
- Coated with black EDP
- Sold individually, please specify left or right hand side
- Oversize freight policy



B24031 L/H - 1 Pc. / Box

B24032 R/H - 1 Pc. / Box

Rear Fender for 1933-34 Ford Passenger Car



B24034



B24033

B24033 L/H - 1 Pc. / Box

B24034 R/H - 1 Pc. / Box

Rear Fender for 1932 Ford 5W Coupe & Roadster



B20334



B20333

B20333 L/H - 1 Pc. / Box

B20334 R/H - 1 Pc. / Box

Rear Fender for 1932-34 Ford Truck



B21032

B21031



B21034

B21033

B21031 32 Truck L/H - 1 Pc. / Box

B21032 32 Truck R/H - 1 Pc. / Box

B21033 33-34 Truck L/H - 1 Pc. / Box

B21034 33-34 Truck R/H - 1 Pc. / Box

For Ford Truck



Roof Assembly for 1932 Ford Truck

- Desirable version without rib
- Also perfect fit on 1933-34 truck
- Exact replica of original die stamped roof assembly
- Includes visor with support, door header structure, structural ribs, and wiper mount
- United Pacific Classic-Coat® weldable primer

B21052 1 Pc. / Box

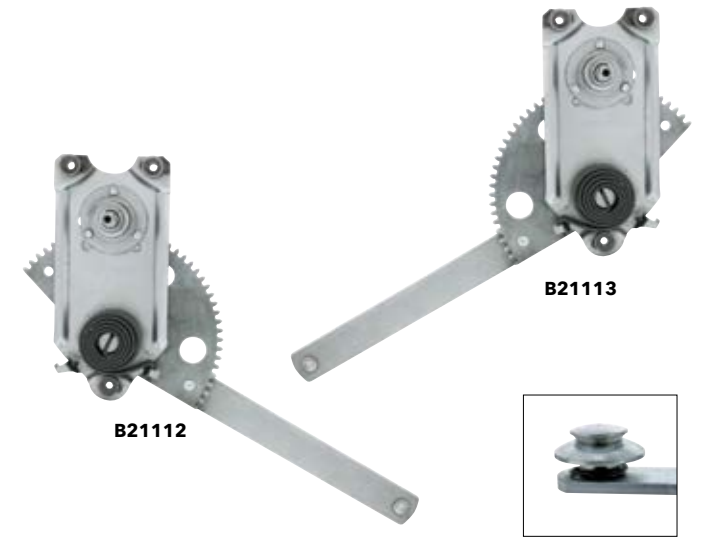

B21112

B21113

Window Regulator for 1932-34 Ford Truck

- Original style regulator with correct spring loaded guide roller
- Also fits 1932 5-Window coupe back window

B21112 R/H - 1 Pc. / Box

B21113 L/H - 1 Pc. / Box

Also Available



B20147



B20148



B21124

B21123

B-Pillar Door Striker Jamb for 1932-34 Ford Truck

- Die stamped steel exactly as original
- Includes floating threaded nut plate for door striker mounting
- United Pacific Classic-Coat® weldable primer

B21123 L/H - 1 Pc. / Box

B21124 R/H - 1 Pc. / Box



Inside Door Handle for 1932-34 Ford Truck

- Inside door handle for 1932-34 Ford Truck

B20146 1 Pc. / Bulk



B21114

B21115

Lower Glass Mental Channels for 1932-34 Ford Truck

- High tensile strength steel just like original
- Regulator roller track has correct concave shape for smooth operation
- Use with original rubber seal or glass setting tape, no need to glue!
- Black EDP finish

B21114 R/H - 1 Pc. / Box

B21115 L/H - 1 Pc. / Box



Chrome Rear Bumper for 1964.5-66 Ford Mustang

- Made of heavy duty 13 gauge steel
- Beautifully chrome plated with triple plating process
- Features all the original contour and detail
- Precision punched square carriage bolt holes for straight forward installation
- Show ready chrome plating finish

110486 1 Pc. / Box



Chrome Center Hubcap for 1978-84 Ford F250/F350 Truck

- Quality die stamped steel and chrome plated
- Satin black painted accent as original
- Fits 3/4 & 1 ton Ford trucks and vans
- 12-5/16" dia.
- Sold each

110751 1 Pc. / Box



15" Woodgrain Steering Wheel for 3-Bolt Hubs

- Wood grip with finger grooves and aluminum rivets
- 304 stainless steel spokes
- Dish depth : 4"
- This steering wheel is compatible with ALL 3-bolt steering wheel hub kits on the market
- Hub adaptor and horn button kit sold separately

110794 1 Pc. / Box



Bumper Bolt Set for 1966-77 Ford Bronco & 1964.5-70 Ford Mustang

- Highly Polished 1" Long 7/16-14 Carriage Bolt to Match that Beautifully Polished Front and Rear Bumper
- Includes Spring Wave Washers and Serrated 7/16-14 Flange Locknuts
- Two Extra 5/16-18 Polished Carriage Bolts and Nuts for the Mustang Front Bumper

110536 1 Set / Card



4 Pcs. Cowl Brace Set for 1966-77 Ford Bronco

- High quality 17 and 19 gauge stamped steel
- Finish with black EDP protective coating
- Fills the empty upper corner area between the windshield cowl mount and the A-pillar

110590 1 Set / Bulk

For Chevy & GMC Trucks

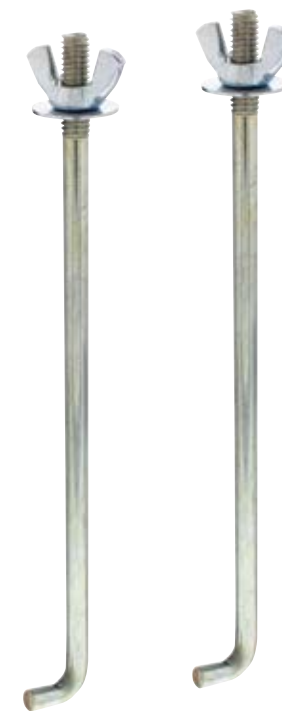

Battery Hold Down Bolt Set for 1955-59 Chevy

- Clear zinc plating hold down bolts with washer

110807 1 Set / Bulk



Chrome Plated Steel Running Board for 1947-54 Chevy & GMC Shortbed Truck

- Ribbed style just like original
- Underside retainer brackets pre-welded for easy installation
- Sold individually, please specify L/H or R/H side

170473

L/H - 1 Pc. / Box

170474

R/H - 1 Pc. / Box

LED Work Light



COMPETITION SERIES **1000 Lumens** **12v/24v** **IP68 WATERPROOF**

5 LED High Power Mini Round Work Light

- 5 high power LED lights with spot or flood function for powerful performance
- IP68 waterproof with die cast housing and sealed polycarbonate lens provide maximum protection & durability
- Solid state design resists shock and vibration

36461	Flood - 1 Pc. / Color Box
36463	Spot - 1 Pc. / Color Box



COMPETITION SERIES **1000 Lumens** **12v/24v** **IP68 WATERPROOF**

5 LED High Power Mini Square Work Light

- 5 high power LED lights with spot or flood function for powerful performance
- IP68 waterproof with die cast housing and sealed polycarbonate lens provide maximum protection & durability
- Solid state design resists shock and vibration

36462	Flood - 1 Pc. / Color Box
36464	Spot - 1 Pc. / Color Box

NEW ITEMS

Parts & Accessories for Ford, Chevy Truck & Mustang

For 1953-56 Ford

38 Red LED Tail Light for 1953-56 Ford Truck

- Super bright LED with excellent quality red polycarbonate lens
- Additional white LED with clear lens for license plate light
- 1157 double connector with offset pins, plugs into existing socket
- Electronics completely sealed in epoxy to resist corrosion and moisture
- Energy efficient solid-state circuit board engineered for 12VDC systems
- Recommended under dash flasher United Pacific 90652 (2-terminal) or 90651 (3-terminal)
- Sold individually, please specify left or right hand side

110142	L/H - 1 Pc. / Card
110143	R/H - 1 Pc. / Card



110142

110143



1000 Lumens

Magnetic Rechargeable LED Work Light

- High power portable LED flood light with polycarbonate lens
- 3 brightness options: 30% / 70% / 100%
- 3 flashing options: Fast / Slow / S.O.S.
- Solid state design resists shock and vibration
- The ultra-strong magnetic base holds the light to most metallic surfaces
- USB port for recharging cell phones
- Rechargeable lithium battery provides 4 hours of run time

36624	1 Pc. / Color Box
--------------	-------------------



110786

110789

Vent Window Assembly for 1968 Ford Mustang

- Die cast chrome plated with highly polished stainless steel glass frame and division bar
- Factory assembled with high quality rubber seal
- Exact design as original for a straight forward replacement
- Period correct chrome vent window handle
- Includes door glass channel with felt
- Available with crystal clear non-tinted tempered window glass or original style green tinted tempered window glass
- Sold individually, please specify left or right hand side

110786	R/H Clear - 1 Pc. / Box
110787	L/H Clear - 1 Pc. / Box
110788	R/H Tint - 1 Pc. / Box
110789	L/H Tint - 1 Pc. / Box

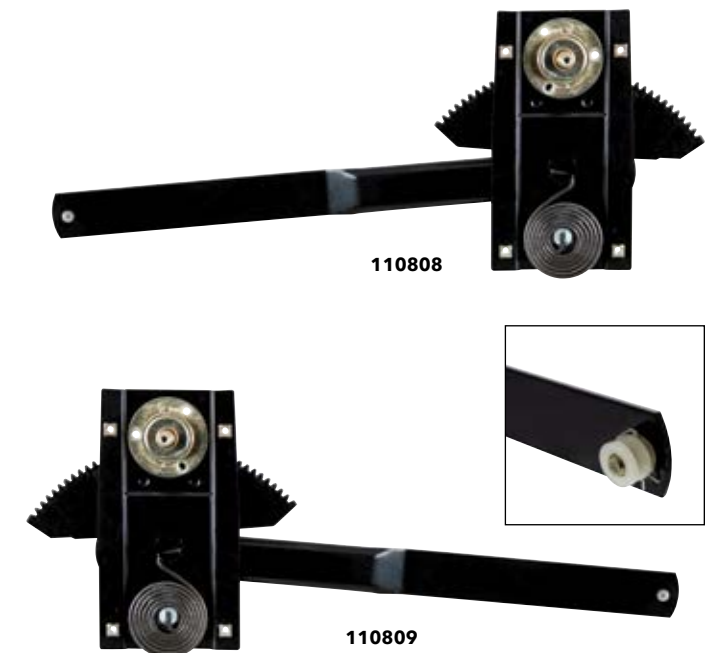

110808

110809

Window Regulator for 1966-77 Ford Bronco

- Excellent quality high strength steel stamping
- Original style counter balance spring design
- OEM specification for easy installation
- Window channel roller and retainer ring included
- Replace OEM number: 710270058501 (L/H) / 710270058518 (R/H)
- Sold individually, please specify left or right hand side

110808	L/H - 1 Pc. / Bulk
110809	R/H - 1 Pc. / Bulk



USB port / 1 amp max

12 volt vehicle charger 110 volt charger

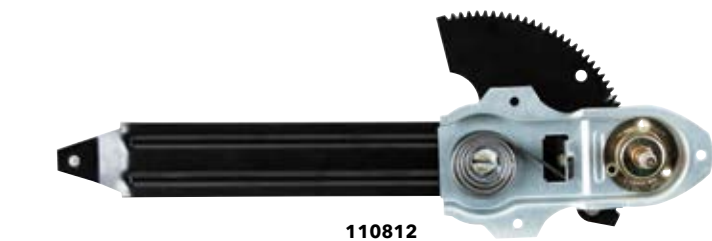

110812



110813

Window Regulator for 1973-79 Ford Truck & 1978-79 Ford Bronco

- Excellent quality high strength steel stamping
- Original style counter balance spring design
- OEM specification for easy installation
- Replace OEM number: 710270058549 (L/H) / 710270058556 (R/H)
- Sold individually, please specify left or right hand side

110812	L/H - 1 Pc. / Bulk
110813	R/H - 1 Pc. / Bulk

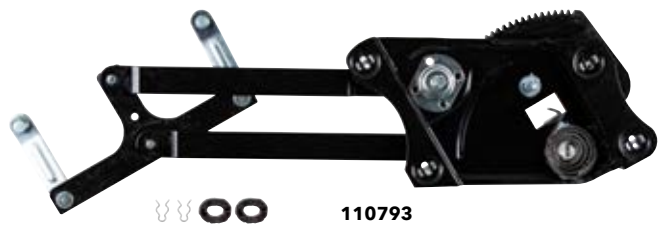

110793



110792

Window Regulator for 1948-52 Ford Truck

- Excellent quality high strength steel stamping
- Original style counter balance spring design
- OEM specification for easy installation
- Retainer clips and mounting hardware included
- Sold individually, please specify left or right hand side

110792	R/H - 1 Pc. / Box
110793	L/H - 1 Pc. / Box



2-1/2"

10"



Interior Rear View Mirror with Day/Night Option for 1968-73 Ford Mustang

- Premium quality mirror glass
- High quality black plastic mirror back housing
- Day/Night switch over function for safer night time driving
- Exact design as original for a straight forward replacement

110711	1 Pc. / Box
---------------	-------------



3/4"

3 1/4"

Chrome Interior Rear View Mirror Bracket for 1968-69 Ford Mustang

- Highly detailed die casting with chrome plating
- Includes mirror head mounting screw

110710	1 Pc. / Box
---------------	-------------

NEW & IMPROVED



22974



22975



22976



22977

U.S. Military Adhesive Metal Medallion - 1 3/4"

- 1 3/4" round U.S. military adhesive metal medallion
- Minted in a brass alloy and finished in bronze
- Officially licensed product

22974	Air Force - 1 Pc. / Bulk
22975	Army - 1 Pc. / Bulk
22976	Navy - 1 Pc. / Bulk
22977	Marine - 1 Pc. / Bulk

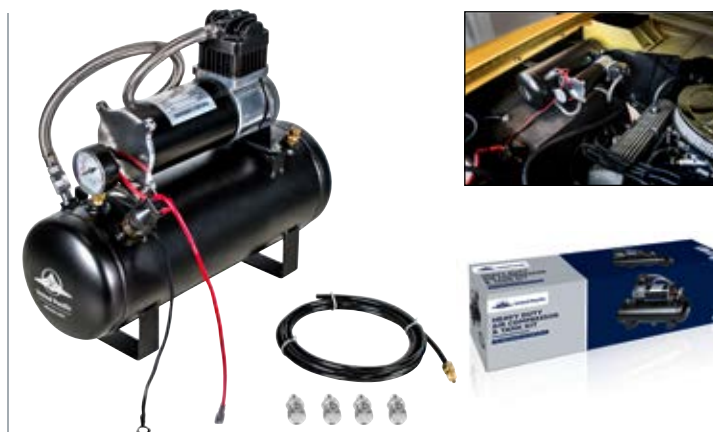

COMPETITION SERIES

Heavy Duty 12V 140 PSI Air Compressor & Tank Kit

- Heavy duty air compressor and tank system
- 140 psi for air horns, general on-board air applications & off-road use
- High volume reciprocating compressor with 1.5 gallon tank permits extended air horn operation
- Automatic on/off pressure switch
- Compressor & tank can be stacked together, or mounted separately to accommodate different mounting locations
- External screw thread hose connector: 1/4NPT & 1/8NPT
- Hose size: O.D. 1/4"
- Sold in set, includes 1 air compressor and 1 air tank
- Kit includes: 12 volt air compressor, steel air tank with safety valve, air pressure gauge, air hose and connector fittings to attach most air horns and mounting hardware & instructions

46154	1 Set / Color Box
--------------	-------------------

10 Quarts Capacity



10qt Da Coolbox Thermoelectric Cooler / Warmer

- Cools without ice, making more space for food and drinks
- Great for travel to keep your contents fresh and dry
- Shoulder strap for easy transportation
- USB charging port for mobile devices
- Selector switch for cool/heat
- Solid, strong exterior for added durability

99121	1 Pc. / Color Box
--------------	-------------------

23 Quarts Capacity



23qt Da Coolbox Thermoelectric Cooler / Warmer

- Cools without ice, making more space for food and drinks
- Great for travel to keep your contents fresh and dry
- Shoulder strap for easy transportation
- USB charging port for mobile devices
- Digital LCD display and temperature adjustment control
- Solid, strong exterior for added durability

99122	1 Pc. / Color Box
--------------	-------------------

NEW ITEMS

March 2019

Parts & Accessories for Ford & Chevy Truck



For 1932-34 Ford Truck

Dash Inner Support Brace for 1932-34 Ford Truck

- Heavy 16 gauge sheet metal stamping
- Exact dash and cowl top inner support curvature as original
- 12-24 D-Nut pre-attached from factory for easy dash installation
- Pre-drilled rivet holes with original specification
- Black EDP coated finish

B21072 1 Pc. / Box



For 1968-72 Chevy Truck



Headlight Switch Knob for 1968-72 Chevy & GMC Truck

- High quality plastic injection molded with durable polypropylene plastic
- Deluxe style with stainless steel center insert
- Original style triangular shape steel rod with notched tip
- Perfect for replacing that wore out and faded knob
- To install, simply push the release button at the top of the switch housing and pull the old knob out, then slide the new one in

110701 1 Pc. / Card



Windshield Wiper Knob for 1968-72 Chevy & GMC Truck

- High quality plastic injection molded with durable polypropylene plastic
- Deluxe style with stainless steel center insert
- Original style "D" profile mounting hole with included set-screw

110700 1 Pc. / Card

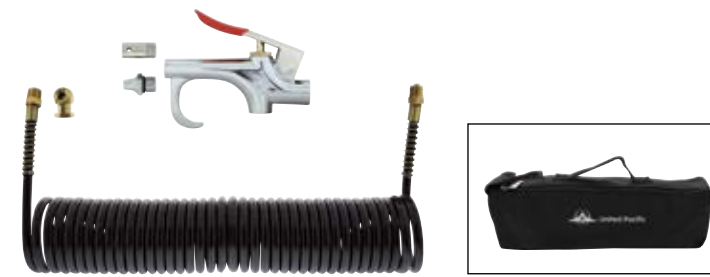

30' Extension Hose with Air Chuck and Air Blow Gun Kit

- Includes air chuck and chrome plated air blow gun
- Quality black nylon bag included

89997 1 Set / Bag



ACC-OFF-ON-START Ignition Plate for 1968-72 Chevy & GMC Truck

- Quality plastic injection molded with durable black ABS plastic
- Raised lettering with chrome finish
- Perfect for replacing that wore out and faded plate
- Mount exactly like original for easy installation

110694 1 Pc. / Card

LED 3rd Brake Light

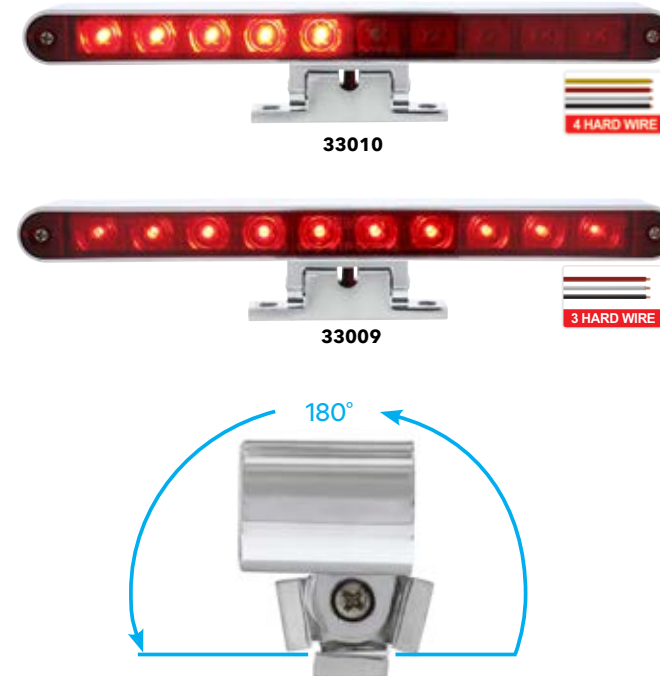

10 LED 3rd Brake Light with Adjustable Pedestal Base

- Designed with adjustable base mount for inside rear window installation
- Available with split LED function for lefthand & righthand turn signal
- Available with running light and brake light
- Base swivels 180° for multiple application



12V 140 PSI Heavy Duty Air Compressor

- Excellent performance in a small form factor
- Design for general on-board air application such as air/train horns and off-road use
- Mounting brackets with vibration dampening brushing
- Kit includes air compressor, high pressure steel braided air hose, wiring harness with in-line fuse, air filter, and mounting hardware

46156 1 Set / Color Box



Split Dual Function Versions:

33010 Split Function Red LED/Red Lens - 1 Pc. / Card

Regular Dual Function:

33009 Dual Function Red LED/Red Lens - 1 Pc. / Card



NEW ITEMS

Parts & Accessories for Ford & Chevy Truck

April 2019

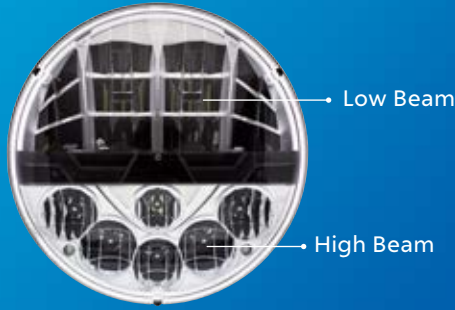

100%LED

DOT & SAE APPROVED

High Power LED 7" Headlight with Polycarbonate Lens & Housing

- High power 12 LED headlight for powerful performance
- Durable corrosion resistant polycarbonate lens & housing
- Solid state design resists shock and vibration
- DOT/SAE headlight compliant
- Easy connection, fits OEM housing, plugs into existing wiring harness, position light requires additional wiring

31084 1 Pc. / Card

Technical Specification	
Low Beam Application 500 Lumens / 5700K 12V/24V Multiple Voltage	High Beam Application 950 Lumens / 5700K 12V/24V Multiple Voltage

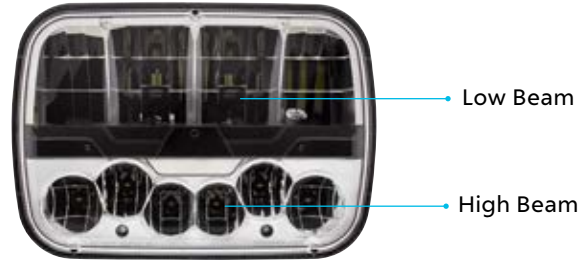

100%LED

DOT & SAE APPROVED

High Power LED 5"x 7" Headlight with Polycarbonate Lens & Housing

- High power 12 LED headlight for powerful performance
- Durable corrosion resistant polycarbonate lens & housing
- Solid state design resists shock and vibration
- DOT/SAE headlight compliant
- Easy connection, fits OEM housing, plugs into existing wiring harness, position light requires additional wiring

31087 1 Pc. / Card



100%LED

DOT & SAE APPROVED

Technical Specification	
Low Beam Application 800 Lumens / 6500K 12V/24V Multiple Voltage	High Beam Application 1000 Lumens / 6500K 12V/24V Multiple Voltage

High Power LED 4"x 6" Headlight with Polycarbonate Lens & Housing

- High power 5 LED low beam headlight for powerful performance
- Durable corrosion resistant polycarbonate lens & housing
- Solid state design resists shock and vibration
- DOT/SAE headlight compliant
- Easy connection, fits OEM housing, plugs into existing wiring harness, position light requires additional wiring

31088 Low Beam - 1 Pc. / Card
31089 High Beam - 1 Pc. / Card



Pool Ball Gearshift Knob

- Beautiful gloss pool ball gearshift knob
- Brushed aluminum mounting base adapter
- Hex screw mount design, includes nylon reducing bushings to fit smaller shifters

70661	#1 - 1 Pc. / Card
70662	#2 - 1 Pc. / Card
70663 (NEW)	#3 - 1 Pc. / Card
70754 (NEW)	#4 - 1 Pc. / Card
70755 (NEW)	#5 - 1 Pc. / Card
70756 (NEW)	#6 - 1 Pc. / Card
70757	#7 - 1 Pc. / Card
70025	#8 - 1 Pc. / Card

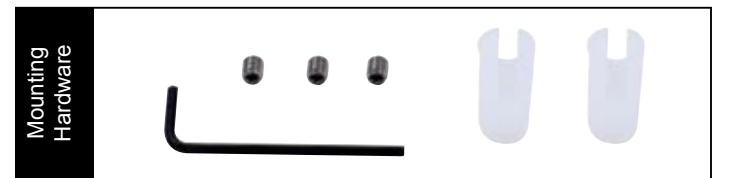

70758 (NEW)	#9 - 1 Pc. / Card
70759 (NEW)	#10 - 1 Pc. / Card
70760 (NEW)	#11 - 1 Pc. / Card
70761 (NEW)	#12 - 1 Pc. / Card
70762 (NEW)	#13 - 1 Pc. / Card
70763 (NEW)	#14 - 1 Pc. / Card
70764 (NEW)	#15 - 1 Pc. / Card



Chrome Spike Nut Cover For 2001-14 Ford F-Series - Push-On

- Fits 1999-2004 Ford F-Series truck models with original steel wheel
- Spike is quality molded plastic with beautiful long lasting chrome plating
- 21mm x 3" push on

10353B 1 Pc. / Bulk



LED Headlight PWM Anti Flicker Module & Adaptor

- Works With Most Vehicles Using Pulse Width Modulated Electrical System, Such as 2007-Present Jeep JK
- Eliminates Flicker on LED Headlamps
- Adapts Common H13 Plug to H4 Plug Used by Most LED Headlights

34217B 1 Pc. / Bulk



2018 New Item Flyer Collection
Item # ANF1218

Available Now!

New Item Flyer Collection

ANF1218 (NEW)	2018 New Items - 1 Pc. / Bulk
ANF1217	2017 New Items - 1 Pc. / Bulk

NEW ITEMS

Parts & Accessories for Ford & Chevy Truck

Sequential Tail Light

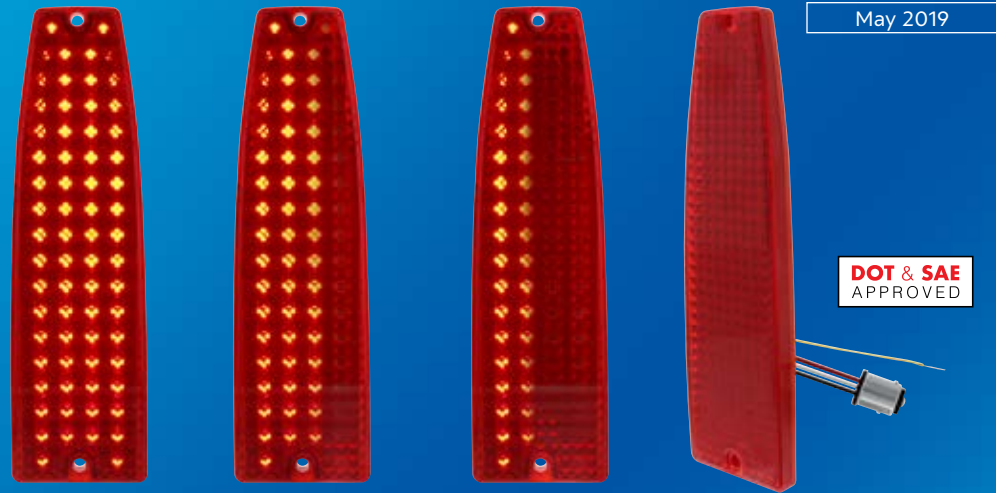

One-Piece Style Sequential LED Tail Light For 1966-67 Chevy II & Nova

- 68 SMD super bright LED with high quality all red polycarbonate lens
- Custom style one-piece design with backup light deleted
- Direct plug & play installation with 1157 type connector
- Electronics completely sealed in epoxy to resist corrosion and moisture
- Solid state circuit board engineered for any 12VDC system
- Lifetime warranty* (see catalog or website for details)
- Recommend to upgrade under dash flasher to item no. 90649 or no. 90652 LED flasher
- Recommend license plate frame with LED back-up light, item no. 50187/50121



(((SEQUENTIAL)))
F · L · A · S · H

(((BRAKE)))
ATTENTION

110360

1 Pc. / Card



One-Piece Style LED Tail Light for 1966-67 Chevy II & Nova

- 68 SMD super bright LED with high quality all red polycarbonate lens
- Custom style one-piece design with backup light deleted
- Direct plug & play installation with 1157 type connector
- Electronics completely sealed in epoxy to resist corrosion and moisture
- Solid state circuit board engineered for any 12VDC system
- Lifetime warranty* (see catalog or website for details)
- Recommend to upgrade under dash flasher to item no. 90649 or no. 90652 LED flasher
- Recommend license plate frame with LED back-up light, item no. 50187/50121

110359 1 Pc. / Card

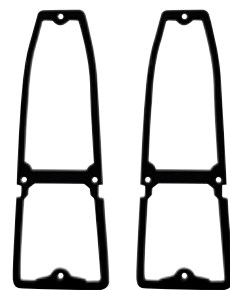

Tail Light Lens Gasket For 1966-67 Chevy Nova

- Quality thick black foam gasket

C666702 1 Pair / Bulk



LED Flasher w/Reverse Polarity Base & Extension Wires

- 12 Volt, 20 Amp maximum
- Solves turn signal problems, such as hyper flashing, no flashing, or burnt out bulb indication when using LED lights and bulbs
- Includes Polarity Reversing Base & Extension Wires

90649 1 Pc. / Card

Sequential Tail Light



DOT & SAE APPROVED

38 LED Sequential Tail Light with Black Housing for 1953-56 Ford Truck

- Super bright SMD LED with high quality all red polycarbonate lens
- Additional white LED with clear lens for license plate light
- Feature sequential function with selector switch to control sequential function off, direction left, or direction right
- Also features a brake attention option with a sequential-once function
- Fully assembled with glossy black die stamped metal housing with mounting studs
- Easy electrical connection with open ended wiring
- Recommended under dash flasher United Pacific 90652(2-terminal) or 90651 (3-terminal)



(((SEQUENTIAL)))
F · L · A · S · H

(((BRAKE)))
ATTENTION

110763

L/H - 1 Pc. / Card

110764

R/H - 1 Pc. / Card



DOT & SAE APPROVED

38 LED Tail Light with Black Housing for 1953-56 Ford Truck

- Super bright SMD LED with high quality all red polycarbonate lens
- Additional white LED with clear lens for license plate light
- Fully assembled with glossy black die stamped metal housing with mounting studs
- Easy electrical connection with open ended wiring
- Electronics completely sealed in epoxy to resist corrosion and moisture
- Solid state circuit board engineered for any 12VDC system
- Recommended under dash flasher United Pacific 90652 (2-terminal) or 90651 (3-terminal)

110759

L/H - 1 Pc. / Card

110760

R/H - 1 Pc. / Card



Windshield A-Pillar Trim Covers for 1932-34 Ford Truck

- High quality 19 gauge stamped steel
- Feature all of the original contour detail
- Precision punched slide arm pivot bracket pass-thru hole
- Countersink mounting screw holes just like original
- Coated in black EDP for corrosion resistance

B21045 1 Pair / Box

For Ford Pickup

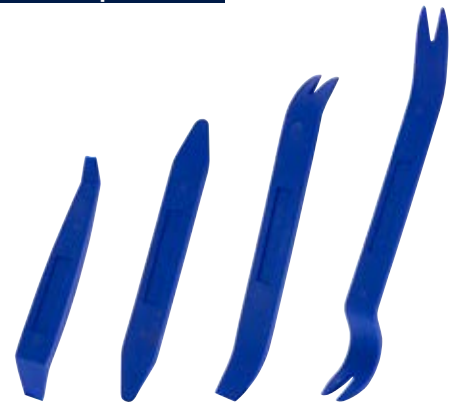

Auto Trim Removal Pry Tool Kit - 4pcs/Kit

- Four-piece kit with different ends to help remove many types of molding, door panels, trims, and dashboards with ease
- Constructed of durable nylon fiber that does not break or bend like ABS plastic
- Soft curve surface prevents accidental scratches or damage to the vehicle or trim

99135 1 Set / Box



Chrome Spike Nut Cover for 2004 - 2014 Ford F-Series with OE Steel Wheel - Push-On

- Molded with quality plastic material
- Beautiful long lasting chrome plating
- Will fit any 13/16" (21mm) wheel lug nuts
- 21mm x 3" push-on type fitting

10352B 1 Pc. / Bulk

For Harley Davidson



Replacement Air Filter Element

- Replacement air filter element for United Pacific item number 46154 & 46156 compressors

46157 2 Pcs. / Bag

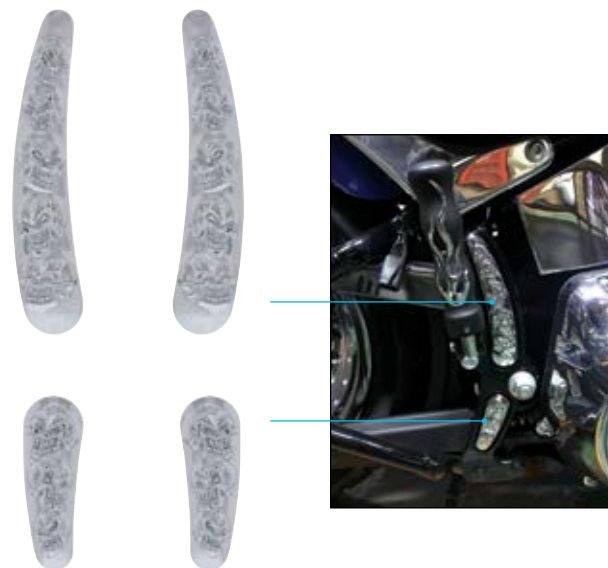

Skull Swing Arm Accent Set

- Fits 2008-17 Harley-Davidson Softail models (except FXCW, FXCWC, FXSB, and FXSBSE)
- Unique four-piece skull accent set to dress up the recessed area in the rear swing arm frame
- Easy to install with pressure sensitive adhesive mounting
- Beautifully chrome plated plastic injection molded
- Add a little attitude to your ride

52010 1 Set / Card

Recommended Item



NEW ITEMS

June 2019

Parts & Accessories for Ford & Chevy Trucks
Sequential Tail Light



DOT & SAE

40 LED Sequential Tail Light Assembly With Red Lens For 1960-66 Chevy & GMC Fleetside Truck

- Super bright red LED with fully sealed epoxy coated electronics
- Features sequential function with selector switch to control sequential function off, direction left, or direction right
- Features sequence-once brake attention function
- Complete with zinc plated housing, lens, gasket, socket & wiring
- OE style wiring with bullet terminal connectors
- Requires use of United Pacific LED turn signal flasher, item number: 90652 or 90649
- SAE/DOT FMVSS108

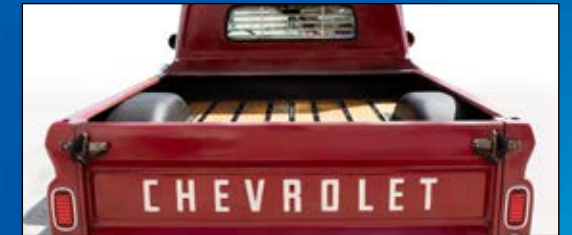

110795

1 Pc. / Card



DOT & SAE

38 LED Sequential Tail Light With Housing For 1953-56 Ford Truck

- Super bright SMD LED with high quality red polycarbonate lens
- L/H side includes additional white LED light with clear lens for license plate light
- Features sequential function with selector switch to control sequential function off, direction left, or direction right
- Features sequence-once brake attention function
- Fully assembled with chrome or gloss black die stamped metal housing, and mounting studs
- Recommended under dash flasher United Pacific 90652(2-terminal) or 90651 (3-terminal)



110761	Chrome (NEW)	L/H - 1 Pc. / Card
110762	Chrome (NEW)	R/H - 1 Pc. / Card
110763	Black	L/H - 1 Pc. / Card
110764	Black	R/H - 1 Pc. / Card



LED Sequential Tail Light With Black Housing For 1940-53 Chevy & GMC Truck

- Super bright red LED with quality polycarbonate lens
- L/H side includes additional white LED light with clear lens for license plate light
- Features sequential operation with selector switch to select sequential left, sequential right, or sequential function off
- Features sequence-once brake attention function
- Fully assembled with gloss black powder coated housing with polished stainless steel bezel
- Electronics completely sealed in epoxy to resist corrosion and moisture
- Solid state circuit board engineered for any 12VDC system
- Recommended under dash flasher United Pacific 90652 (2-terminal) or 90651 (3-terminal)



110415	L/H - 1 Pc. / Box
110416	R/H - 1 Pc. / Box



22 LED Tail Light With LED Blue Dot and Black Housing For 1940-53 Chevy & GMC Truck

- Super bright red LED with quality polycarbonate lens
- Additional white LED with clear lens for license plate light
- Center mounted blue dot can be controlled independently with additional wiring
- Full assembled with gloss black die stamped metal housing with mounting studs and highly polished stainless steel bezel
- Electronics completely sealed in epoxy to resist corrosion and moisture
- Solid state circuit board engineered for any 12VDC system
- Recommended under dash flasher United Pacific 90652 (2-terminal) or 90651 (3-terminal)

C7031RLBD	L/H - 1 Pc. / Box
C7031RRBD	R/H - 1 Pc. / Box



Tail Light With Black Housing For 1940-53 Chevy & GMC Truck

- Beautiful red original style glass lens
- Fully assembled with gloss black powder coated housing with highly polished stainless steel bezel
- Includes additional light with clear lens for license plate light
- Ready to install, 12 volt incandescent bulbs, wiring pigtailed, gaskets

C7001L	L/H - 1 Pc. / Box
C7001R	R/H - 1 Pc. / Box



DOT & SAE

38 LED Tail Light With Housing For 1953-56 Ford Truck

- Super bright SMD LED with high quality red polycarbonate lens
- L/H side includes additional white LED light with clear lens for license plate light
- Fully assembled with chrome or gloss black die stamped metal housing, and mounting studs
- Electronics completely sealed in epoxy to resist corrosion and moisture
- Solid state circuit board engineered for any 12VDC system
- Recommended under dash flasher United Pacific 90652 (2-terminal) or 90651 (3-terminal)

110759	Black	L/H - 1 Pc. / Card
110760	Black	R/H - 1 Pc. / Card



45 LED Tail Light With Black Housing For 1940-53 Chevy & GMC Truck

- Super bright SMD LED with high quality red polycarbonate lens
- L/H side includes additional white LED light with clear lens for license plate light
- Fully assembled with gloss black powder coated housing with polished stainless steel bezel
- Electronics completely sealed in epoxy to resist corrosion and moisture
- Solid state circuit board engineered for any 12VDC system
- Recommended under dash flasher United Pacific 90652 (2-terminal) or 90651 (3-terminal)

C7031RL	L/H - 1 Pc. / Box
C7031RR	R/H - 1 Pc. / Box



Tail Light With Black Housing And Blue Dot For 1940-53 Chevy & GMC Truck

- Excellent quality red glass lens with beautiful center mounted blue dot
- Fully assembled with gloss black powder coated housing with highly polished stainless steel bezel
- Includes additional light with clear lens for license plate light
- Ready to install, 12 volt incandescent bulbs, wiring pigtailed, gaskets

C7001L-1	L/H - 1 Pc. / Box
C7001R-1	R/H - 1 Pc. / Box

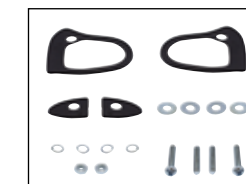

Chrome Outside Door Handle Set for 1966-77 Ford Bronco & 1965-70 Mustang

- Beautiful chrome plated finish with triple chrome plating process
- Excellent reproduction with original contour and size
- Original style inner linkage design for straight forward replacement
- Complete set includes pair of handles, mounting pads and hardware included

110824	1 Pair / Box
---------------	--------------



Inner Header Support For 1932-34 Ford Truck

- Die stamped with high quality 16 gauge steel reproduction
- Features all of original contour detail with mounting holes for windshield frame and wiper vacuum line pass-through
- Inner channel reinforcements included for additional structural rigidity, just like Ford had it
- Finished with United Pacific Classic-Coat® weldable primer

B21071 1 Pc. / Box



A-Pillar Assembly for 1932-34 Ford Truck

- High quality stamped steel with heavy 13 gauge inner structural reinforcements
- Features all of the original contour detail and spot welder pass-thru holes
- Lower triangular inner reinforcement features large ribbing and square carriage bolt holes
- Includes mounting flange with D-nuts for inner dash support
- Slide arm pivot bracket pre-installed with round head solid rivets
- Upper roof mounting flange with reinforcement plate
- Includes upper A-pillar to roof mounting reinforcement plate kit

B21125-A L/H - 1 Pc. / Box

B21126-A R/H - 1 Pc. / Box



Stainless Steel Gas Cap for 1930-31 Ford Model A

- Highly polished quality stainless steel
- Exact shape and size as the original
- Knurled on the edge as original for easy grip while turning

A8045 1 Pc. / Box



Chrome Bronco Key Chain/Bottle Opener

- Beautiful highly detailed life-like bucking bronco
- Quality chrome plated die cast with triple chrome plating process
- Heavy duty, quality you can feel
- Features a special designed cut out at the rear to work as a bottle opener
- Round split keychain ring included

99102 1 Pc. / Card

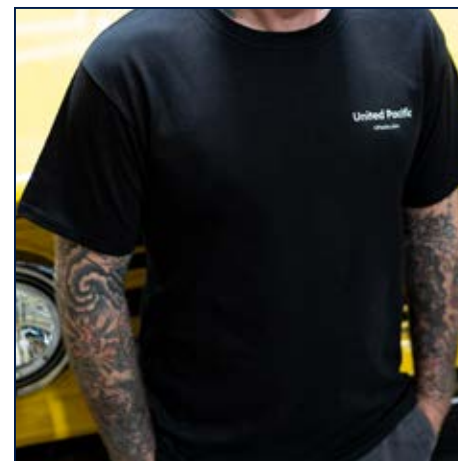

United Pacific x Maxlider T-shirt with Ford Bronco

- Black T-Shirt

99129M Medium - 1 Pc. / Bulk

99129L Large - 1 Pc. / Bulk

99129XL X-Large - 1 Pc. / Bulk

99129XXL XX-Large - 1 Pc. / Bulk



4' x 3' United Pacific Banner

- United Pacific banner

99053 1 Pc. / Bulk

NEW ITEMS

July 2019



Bedside exterior



Bedside interior

Shortbed Bedside Panel For 1968-72 Chevy & GMC Fleetside Truck

- Reproduced exactly like the original with high quality 20-gauge steel, stamped with all the original contour and detail
- Complete bedside, Includes installed and spot welded 17 gauge inner liner
- Features 3/8-16 and 5/16-18 threads welded in between exterior steel panel and inner reinforcement
- Black EDP Coated
- Includes rubber tailgate bumpers
- Has side marker cutout for 1968-72, but can be used on 1967 if side marker is desired
- Packed in heavy-duty cardboard box

110829 L/H - 1 Pc. / Box

110830 R/H - 1 Pc. / Box

UNITED PACIFIC BEDSIDES

United Pacific is the source for quality body panels for long bed to short bed conversions. By reverse engineering each panel with exact specifications and modern technology, we are able to create a complete replica of short bed C10 bedside panels. Our high quality 20-gauge steel panels are manufactured with pre-drilled mounting holes, and feature our exclusive welded threaded nut inserts for wheel well, tailgate pivot trunnion, tailgate support and striker.

United Pacific's goal is to ensure that our parts have the best possible fit and make sure installation is a breeze. We are here to help the C10 community restore and rebuild the truck of their dreams.



For Ford Bronco



Black Grille Without Logo For 1966-68 Ford Bronco

- Die Stamped with high quality 16 gauge sheet metal
- Features all the original contour and detail and mounting brackets for the early small round signal lights
- Smooth center bar design without FORD letters to keep that clean front end look
- Finish with black EDP protective coating to keep your new steel fresh and rust-free
- Headlight adjusters also included for easy headlight installation and adjustment



110513 1 Pc. / Box

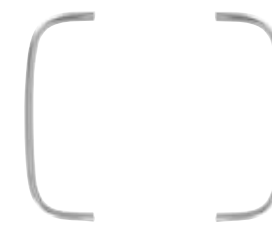

Polished Aluminum Grille Trim Molding Kit For 1966-77 Ford Bronco

- Beautiful polished high quality aluminum extrusion with clear anodizing
- Overlapped connecting ends just like original
- Original type mounting hardware included

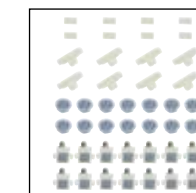

110594 1 Set / Box



Front Fender Support Bracket, Front For 1966-77 Ford Bronco

- Heavy duty steel rod with flattened ends
- Same exact length as original for easy installation
- 5/16-18 threaded mounting holes
- Zinc plated

110592 L/H - 1 Pc. / Bag

110593 R/H - 1 Pc. / Bag



Quarter Panel Support Brackets For 1966-77 Ford Bronco

- Heavy duty steel rod with flattened ends
- Same exact length as original for easy installation
- 1/4-20 threaded mounting holes
- Zinc plated

110591 1 Pc. / Bag



Glove Box Door Hinge For 1964-66 Chevy & GMC Truck

- Excellent quality steel stamping
- Exact design as original with mounting holes for easy installation
- Finish with black EDP protective coating

110094 1 Pc. / Box

Universal Products



Chrome Wiper Shaft Cap For 0.55" Dia Shafts

- Metal die cast zinc with quality chrome plating
- Dress up the wiper shaft when wiper arms are not in use
- Easy installation and removal with included set screw & allen wrench
- Sold in pairs

110823 1 Pair / Card



Chrome Wiper Shaft Bullets

- Beautiful chrome plated with triple chrome plating process
- Securely mounts onto wiper shaft via included set screws
- Matching hex key also included
- Please double check wiper shaft diameter before purchase

C4041 0.55 Dia. - 1 Pair / Card

C4041L 5/8" Dia. - 1 Pair / Card



NEW ITEMS

Parts & Accessories for Ford & Chevy Trucks



UNITED PACIFIC BODY PANELS

United Pacific is the source for quality body panels for long bed to short bed conversions. By reverse engineering each panel with exact specifications and modern technology, we are able to create a complete replica of short bed C10 bedside, bed floor pan and tailgate panels. Our high-quality heavy steel panels are manufactured with mounting holes and feature our exclusive welded nut inserts for wheel well, tailgate pivot trunnion, tailgate support and striker.

United Pacific's goal is to ensure that our parts have the best possible fit and make sure installation is a breeze. We are here to help the C10 community restore and rebuild the truck of their dreams.



6-1/2' Bed Floor Pan For 1967-72 Chevy & GMC Truck Fleetside Shortbed

- Excellent stamped sheet metal reproduction with all of the original contour detail
- Quality 18 gauge floor panel with spot welded heavy 14 gauge crossmembers
- Features precision punched mounting holes for easy bed front, bed side, and wheel well installation
- Finished with black EDP protective coating

110839 1 Pc. / Box



Tailgate With GMC Script For 1967-72 GMC Fleetside Truck

- Die stamped quality 17 gauge steel with recessed GMC lettering
- Precision cut latch handle pocket with mounting holes
- Two welded 5/16-18 nuts on each side for latch mounting
- Includes tailgate linkage posts and tailgate trunnion pockets
- Finish with black EDP protective coating to keep your new steel fresh and rust-free

110847 1 Pc. / Box





Glove Box Door For 1964-66 Chevy Truck

- Excellent stamped 20 gauge steel reproduction with all of the original contour detail
- Features precision cut lock cylinder pocket, rectangular front recess for OE Chevrolet emblem, and three OE style cup holder recesses on inner panel
- Includes welded 1/4-20 square nuts
- Finished with black EDP protective coating

110092 1 Pc. / Box

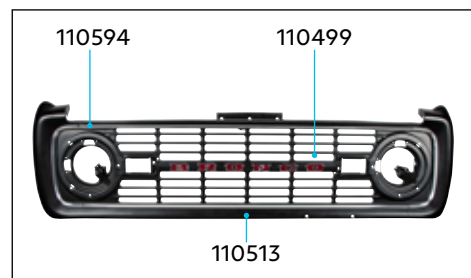

Chrome "BRONCO" Grille Letter Set

- High quality die cast & chrome plated with gloss red inlay
- 12 speed nuts included
- Excellent upgrade for all 1966-77 Ford Broncos
- Drill template included for easy installation
- Unique design made for aftermarket smooth style grilles without FORD lettering
- Official licensed product by Ford Motor Company

110499 1 Set / Card

For Ford 32 Car & Truck

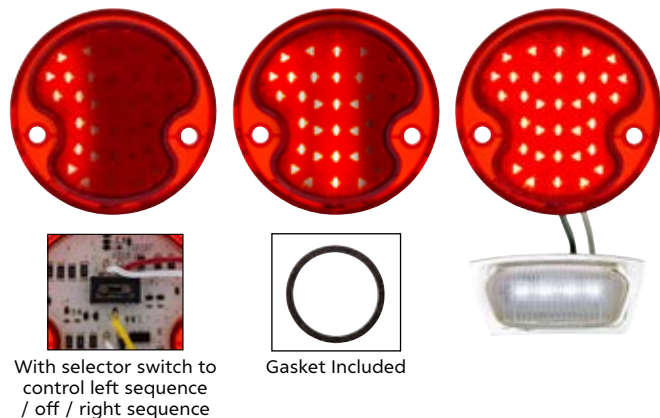

LED Sequential Tail Light For 1932 Ford Car & Truck

- Super bright LED, complete with polycarbonate lens
- L/H Includes bright LED license plate illuminator lens on bottom
- Feature sequential function with selector switch to control sequential function off/on
- Also features brake attention option with sequence-once function
- Epoxy coated, fully sealed electronics
- Energy efficient solid-state circuit board engineered for 12VDC systems
- Recommend to upgrade under dash flasher to item no. 90652 or 90649 LED flasher

110196 L/H - 1 Pc. / Card
110197 R/H - 1 Pc. / Card

For Volkswagen



15 3/4" Steering Wheel for 1962-71 Volkswagen Beetle, Karmann Ghia and Type 3

- OEM style 15-3/4" steering wheel
- Includes chrome horn ring, horn button with Wolfsburg crest, horn contact ring, mounting hardware kit and instructions

110716 Black - 1 Pc. / Color Box
110717 Gray Beige - 1 Pc. / Color Box



P-40 "Warhawk" Shark Mouth 17" Tire Checking Bat

- Aluminum tire checker in military green with WWII P40 style shark mouth decal
- 17" long with comfortable anti-slip grip

99136 1 Pc. / Box



High Power 8 LED 1156 Bulb

- 8 High Power SMD LED's
- Replaces most #1156 and #89 applications
- 12 Volt, single contact with straight-across pins

38897 White / 250 lm - 2 Pcs. / Color Box
38898 Red / 150 lm - 2 Pcs. / Color Box
38899 Amber / 150 lm - 2 Pcs. / Color Box



Plug & Play

NEW ITEMS

September 2019

Parts & Accessories for Chevy Trucks and Camaro Backup Light



Tailgate With CHEVROLET Script For 1967-72 Chevy Fleetside Truck

- Die stamped quality 16 gauge steel with recessed CHEVROLET lettering
- Precision cut latch handle pocket with mounting holes
- Two welded 5/16-18 nuts on each side for latch mounting
- Includes tailgate linkage posts and tailgate trunion pockets
- Finish with black EDP protective coating to keep your new steel fresh and rust-free
- Official GM licensed restoration product

110846 1 Pc. / Box



Tailgate Without Script For 1967-72 Chevy & GMC Fleetside Truck

- Die stamped quality 16 gauge steel
- Precision cut latch handle pocket with mounting holes
- Two welded 5/16-18 nuts on each side for latch mounting
- Includes tailgate linkage posts and tailgate trunion pockets
- Finish with black EDP protective coating to keep your new steel fresh and rust-free

110845 1 Pc. / Box

Lower Door Hinge For 1967-72 Chevy & GMC Truck

- High quality door hinge assembly with bronze bushing and high strength hinge pin
- Made to OE specifications for adjustability and door alignment
- Also fits 67-72 Suburban, 69-72 Chevy Blazer & GMC Jimmy

110835 L/H - 1 Pc. / Box

110836 R/H - 1 Pc. / Box



110836



110835

Chrome Front Bumper Without Impact Strip Holes For 1973-80 Chevy & GMC Truck

- Heavy 14 gauge stamped steel with quality chrome plating
- Smooth clean style without the mounting holes for bumper impact strip
- Precision punched square carriage bolt holes for straight forward installation
- Features recessed license plate pocket with mounting holes



110849 1 Pc. / Box

Chrome Rear Bumper Without Impact Strip Holes For 1973-80 Chevy & GMC Truck

- Heavy 14 gauge stamped steel with quality chrome plating
- Smooth clean style without the mounting holes for bumper impact strip
- Precision punched square carriage bolt holes for straight forward installation
- Features license plate clearance pocket



110850 1 Pc. / Box

Chrome Front Bumper With Impact Strip Holes For 1983-87 Chevy & GMC Truck

- Heavy 14 gauge stamped steel with quality chrome plating finish
- Original style with impact strip mounting holes
- Precision punched square carriage bolt holes for straight forward installation
- Features recessed license plate pocket with mounting holes



110852 1 Pc. / Box

Chrome Rear Bumper Without Impact Strip Holes For 1981-87 Chevy Truck

- Heavy 14 gauge stamped steel with quality chrome plating finish
- Smooth clean style without the mounting holes for bumper impact strip
- Precision punched square carriage bolt holes for straight forward installation
- Features license plate clearance pocket



110853 1 Pc. / Box

18 High Power 4"X 6" LED Rectangular Light With Position Light - Black

- LED dual function rectangular light with 10 white LED position lights
- Ultra slim housing design for easier installation
- High beam: 3500 Lumens/6500K; Low beam: 1500 lumens/6500K; Position light: 100 lumens
- Rugged anti-vibration construction. 12VDC - 24VDC
- Easy connection, fits OEM housing or fender, plugs into existing wiring harness, position light requires additional wiring
- Off-Road use only



100%LED

IP67
WATER RESISTANT



36449 1 Pc. / Color Box

22 High Power 5"X 7" LED Rectangular Light With Position Light - Black

- LED dual function rectangular light with 12 white LED position lights
- Ultra slim housing design for easier installation
- High beam: 4000 lumens; Low beam: 2000 lumens; Position light: 100 lumens
- Rugged anti-vibration construction. 12VDC - 24VDC
- Easy connection, fits OEM housing or fender, plugs into existing wiring harness, position light requires additional wiring
- Off-Road use only



100%LED

IP67
WATER RESISTANT



36450 1 Pc. / Color Box



30 LED Tail Light For 1970-73 Chevy Camaro

- Super bright red LED with high quality injection molded polycarbonate lens
- Includes original style polished stainless steel lens trim attached
- Includes polished stainless steel lens trim attached
- Dual function with tail light & bright stop/turn signal
- Epoxy coated, fully sealed electronics
- Easy wiring with hard wired 1157 double contact plug
- Direct plug-n-play with no vehicle modification required
- Recommend to upgrade under dash flasher to item # 90652 or 90649 LED flasher
- SEMA Global Media Award winner

CTL7073LED-L	L/H - 1 Pc. / Card
CTL7073LED-R	R/H - 1 Pc. / Card

30 LED Backup Light For 1970-73 Chevy Camaro

- Super bright white LED center backup light with 18 additional dual function red LED light
- Features polished stainless steel lens trim with quality polycarbonate lens
- Additional red LED are design for tail/stop/turn signal light use (quick splice connectors included)
- Fully sealed electronic solid state circuit boards are designed to operate at 12 VDC
- Easy electrical connection, direct plug-n-play to original wiring harness with hardwired 1156 plug
- Red LED wiring color code: White wire-ground, yellow wire-tail, red wire-stop/turn

110375	L/H - 1 Pc. / Card (NEW)
110376	R/H - 1 Pc. / Card (NEW)

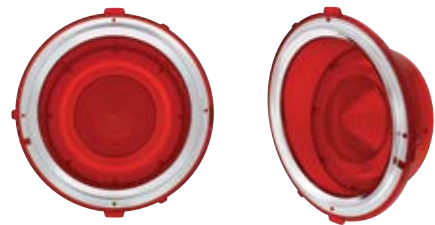

Tail Light Lens Only For 1970-73 Chevy Camaro

- High quality injection molded polycarbonate lens
- Quality stainless steel outer bezel

110099	L/H - 1 Pc. / Card
110100	R/H - 1 Pc. / Card

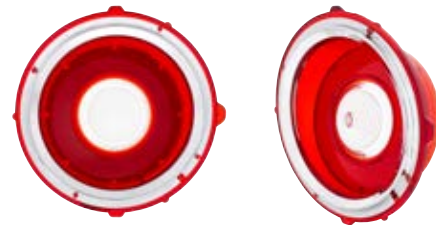

Backup Light Lens Only For 1970-73 Chevy Camaro

- High quality injection molded polycarbonate lens
- Quality stainless steel outer bezel

110377	L/H - 1 Pc. / Card (NEW)
110378	R/H - 1 Pc. / Card (NEW)

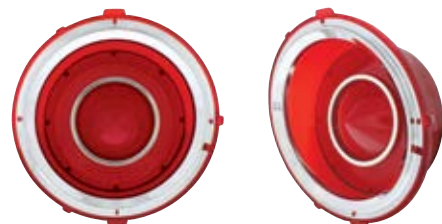

Tail Light Lens For 1970-73 Chevy Camaro Rally Sport

- High quality injection molded polycarbonate lens
- Quality stainless steel inner and outer bezel

110101	L/H - 1 Pc. / Card
110102	R/H - 1 Pc. / Card

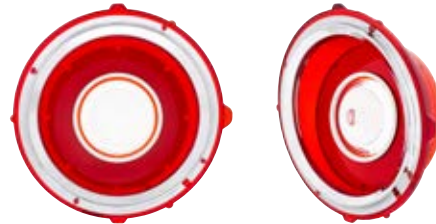

Backup Light Lens For 1970-73 Camaro Rally Sport

- High quality injection molded polycarbonate lens
- Quality stainless steel inner and outer bezel

110379	L/H - 1 Pc. / Card (NEW)
110380	R/H - 1 Pc. / Card (NEW)



LED Sequential Tail Light W/ Stainless Steel Housing For 1932 Ford Car & Truck

- Highly polished stainless steel housing & rim
- Pre-assembled with quality polycarbonate red LED lens
- L/H includes bright LED license plate illuminator lens on bottom
- Feature sequential function with selector switch to control sequential function off/on
- Also features brake attention option with sequence-once function
- Epoxy coated, energy efficient solid-state circuit board engineered for 12VDC systems
- Vintage style cloth braided green and black nylon coated wires for an authentic look
- Recommend to upgrade under dash flasher to item no. 90652 or 90649 LED flasher

110872	R/H - 1 Pc. / Card
110873	L/H - 1 Pc. / Card



Front Fender Lower Brace With J-Nuts For 1966-77 Ford Bronco

- High quality die stamped 18 gauge sheet metal
- Features strengthening center rib just like original
- Includes 5/16-18 J-nuts for easy installation to fender and fender apron
- Zinc plated finish for better corrosion resistance

110596	1 Pc. / Bulk
---------------	--------------



Slide Arm Pivot Bracket For 1932-34 Ford Truck

- Excellent quality steel reproduction with all of original contour detail
- Machine cut OE specification 5/16"-18 threads
- Precision punched rivet holes for straight forward installation to A-pillar
- Zinc plated finish for better corrosion resistance

B21125-1	1 Pc. / Bulk
-----------------	--------------



Complete Tinted Door Glass Assembly For 1967-68 Mustang Convertible

- Heavy 16 gauge stamped channel with riveted track rollers
- Polished stainless steel upper glass frame
- Original style green tinted tempered window glass
- Fully assembled from factory for a quick and easy replacement

110626	R/H - 1 Pc. / Box
110627	L/H - 1 Pc. / Box



Window Regulator For 1967-72 Ford Truck

- Excellent quality high strength steel stamping
- Original style counter balance spring design
- Features 1/4-20 square nuts for easy installation to door shell
- Includes window crank mounting screw
- Fits 1967 models, but require 68-72 window handle and escutcheon

110810	L/H - 1 Pc. / Bulk
110811	R/H - 1 Pc. / Bulk



Spider Wheel Hub Cover (4/Set)

- Made of die-cast steel, not plastic
- Show quality chrome plating
- Comes Complete With Mounting Hardware
- These fit on most wheels to give your vehicles the cool look
- Set of four

C8056	5 x 4 3/4" - 1 Set / Box
C8061	5 x 5" - 1 Set / Box
C8062	5 x 5 1/2" - 1 Set / Box

Back In Stock

NEW ITEMS

October 2019



LED Sequential Tail Light With Trim For 1973-87 Chevy & GMC Truck

- 56 Super bright red LED tail light with 12 LED white back-up light
- Features sequential operation with brake attention feature, and selector switch to turn off if desired
- Special tail light mounting base plate included
- Electronics completely sealed in epoxy to resist corrosion and moisture
- Requires use of United Pacific LED turn signal flasher, item number 90652 or 90649



110843 L/H - 1 Pc. / Card
110844 R/H - 1 Pc. / Card

Back In Stock



Cab Mounting Kit For 1967-72 Chevy & GMC 1/2 Ton Truck

- Quality molded rubber cab mounts
- Includes all mounting bolts, lock nuts, spacers and large washers
- 38 piece kit

C677204 1 Set / Bulk

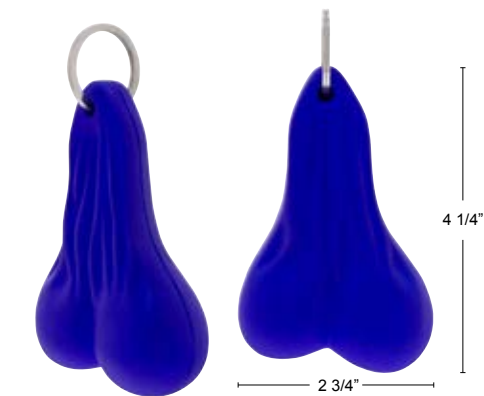

4-1/4" Stress Ballz Novelty Keychain - Blue

- Stress relieving novelty keychain made of squishy foam
- Great for relieving stress and anxiety on the go
- 1-1/4" stainless split key ring included

78027 1 Pc. / Card



Tailgate Chain Cover For 1932 Ford Truck

- Engineered leather - long lasting look & feel of leather
- Easy Installation with high strength leather
- WARNING: Sharp objects may damage and cause tears
- CLEANING: Use vinyl interior cleaner

B21521 1 Pc. / Bulk



Vintage Flashlight Holder With Roller-Action Grip, Grey

- Tightly holds flashlight within easy reach
- Secure roller-action grip
- Fits steering columns up to 1-7/8" diameter

C5012G Holder Only - 1 Pc. / Color Box
110587 Flashlight with Holder - 1 Set / Box
C5013 Flashlight Only - 1 Pc. / Box



United Pacific Bar Stool

- United Pacific Bar Stool

99041 1 Pc. / Bulk



United Pacific Store Slatwall Display

- Perfect way to display United Pacific products
- Size: 31.5" Wide x 14" Deep x 69" Tall
- Recommended display hooks: item# 99002 and 99002-1

99142 1 Pc. / Box

NEW ITEMS

November 2019

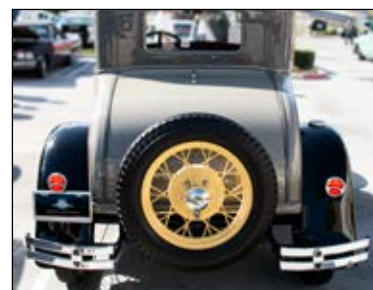

31 LED Red Sequential Tail Light W/LED License Plate Light For 1928-31 Ford Car

- Super bright LED behind high quality red acrylic lens with fully sealed epoxy coated electronics
- Leftahnd includes bright white LED license plate illuminator lens
- Plug & play for 12 volt negative ground systems. Simply plugs into original tail light with two 1156 plugs
- Selector switch to control sequential function off, direction left, or direction right
- Also features a brake attention feature with a sequence - once function
- Recommended under dash 12V flasher United Pacific 90649 (2-terminal) or 90651 (3-terminal)
- DOT & SAE FMVSS108. Not for use with early 1928 "AR" drum tail lights



(((BRAKE ATTENTION)))

(((SEQUENTIAL F.L.A.S.H)))

110194	L/H - 1 Pc. / Card
110195	R/H - 1 Pc. / Card



(((BRAKE ATTENTION)))

(((SEQUENTIAL F.L.A.S.H)))

28 LED Sequential Tail Light For 1957 Chevy Passenger Car

- Super bright red LED with fully sealed epoxy coated electronics
- Selector switch to control sequential function off, direction left, or direction right
- Also features a brake attention feature with a sequence - once function
- 1157 double connector with offset pins, plugs into existing tail lamp socket
- Requires use of United Pacific LED turn signal flasher, item number: 90652 or 90649
- DOT & SAE Compliant

110198	1 Pcs. / Card
---------------	----------------------



Dual Color High Power 12V H11 LED Bulbs - White/Yellow (2 Pack)

- Special engineered 240 degree wide angle dual color LED design
- Primary 6500K white color temp. LED with 1400 lumen output
- Secondary 3000K bright yellow color temp. LED with 1150 lumen output
- Direct plug-n-play to H11 housing and socket
- White LED comes on by default. To switch over, simply turn off and on within 10 seconds
- Yellow LED is designated for fog light use only, not to be use as normal driving light

36468	1 Pc. / Color Box
--------------	--------------------------



110835

110834

Upper Door Hinge For 1967-72 Chevy & GMC Truck

- High quality door hinge assembly with bronze bushing and high strength hinge pin
- Made to OE specifications for adjustability and door alignment
- Upper includes door stop and tension brake to hold door in open position
- Also fits 67-72 Suburban, 69-72 Chevy Blazer & GMC Jimmy

110833	Upper Door Hinge L/H - 1 Pc. / Box
110834	Upper Door Hinge R/H - 1 Pc. / Box
110835	Lower Door Hinge L/H - 1 Pc. / Box
110836	Lower Door Hinge R/H - 1 Pc. / Box



4-1/4" Stress Ballz Novelty Keychain

- Stress relieving novelty keychain made of squishy foam
- Great for relieving stress and anxiety on the go
- 1-1/4" stainless split key ring included

78028	Black - 1 Pc. / Card (NEW)
78029	Red - 1 Pc. / Card (NEW)
78027	Blue - 1 Pc. / Card



Red Bowtie Grille Emblem For 1967-68 Chevrolet Truck

- Excellent die-cast reproduction of the original
- Beautiful original style orange-red inner with vertical groove design
- Quality chrome plated outer housing with black front outline
- Mounting hardware included

110859	1 Pc. / Box
---------------	--------------------



Product Catalog for 1947-87 Chevy & GMC Trucks

- Perfect bound, 124 Page catalog

ACPU01	1 Pc. / Bulk
---------------	---------------------



Spider Wheel Hub Cover (4/Set)

- Made of die-cast metal, not plastic
- Show quality chrome plating
- Comes complete with mounting hardware
- These fit on most wheels to give your vehicles the cool look
- Set of four



Back In Stock

C8056	5 x 4 3/4" - 1 Set / Box
C8057	5 x 4 1/2" - 1 Set / Box
C8061	5 x 5" - 1 Set / Box
C8062	5 x 5 1/2" - 1 Set / Box



SEMA 2019 C10 T-Shirt

- Dark navy t-shirt

99179M	Medium - 1 Pc. / Bulk
99179L	Large - 1 Pc. / Bulk
99179XL	XLarge - 1 Pc. / Bulk
99179XXL	XXLarge - 1 Pc. / Bulk

NEW ITEMS

December 2019



Rectangular Exterior Mirror For 1968-72 Chevy Passenger Car

- Exceptional quality die cast metal and beautifully chrome plated
- Available with LED turn signal arrow hidden inside mirror glass (hidden when off)
- Convex Mirror for Wide Angle Visibility for R/H side
- Includes mounting pad and mounting screws

110294	L/H - 1 Pc. / Color Box
110295	R/H w/Convex Mirror - 1 Pc. / Color Box
110296	L/H w/LED Turn Signal - 1 Pc. / Color Box
110297	R/H w/Convex Mirror & LED Turn Signal - 1 Pc. / Color Box

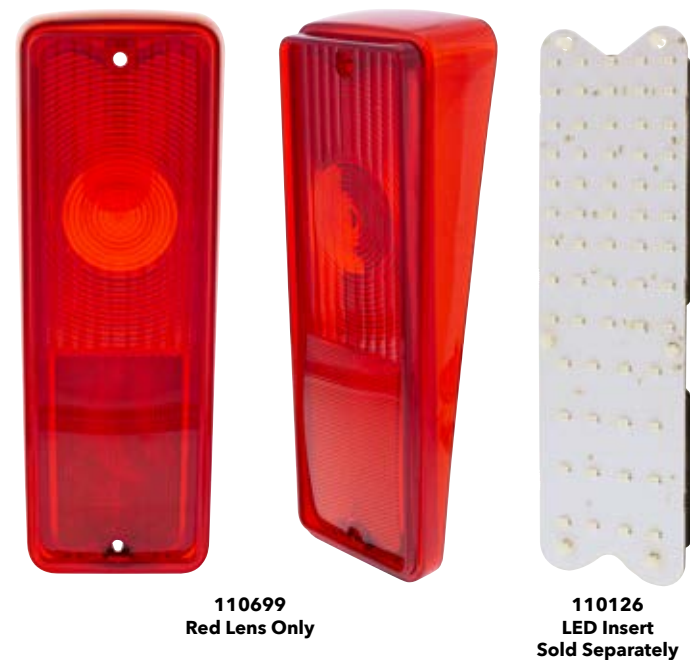

Tail Light Lens For 1967-72 Chevy & GMC Panel Truck & Suburban

- Great looking replacement lens made specifically for Suburban
- Injection molded from high quality red polycarbonate plastic
- Fits both left and right hand side

110699 1 Pc. / Card

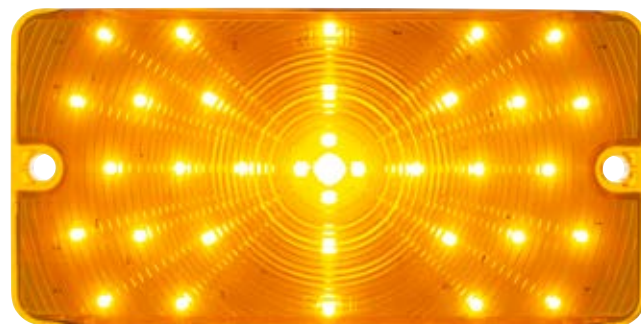

LED Parking/Signal Light For 1969-77 Ford Bronco

- 35 LED Dual function, parking light and turn signal
- Super bright amber LED with amber acrylic lens
- Epoxy coated, fully sealed electronics, 1157 plug
- Fits left hand and right hand
- Also fits 1959-64 Ford F100, F250, F350, and 1968-74 Econoline

110382	Parking Light - 1 Pc. / Card
110803	Gasket - 1 Pc. / Bulk



Front Inner Fender For 1967-72 Chevrolet & GMC Truck

- Also fits 1967-72 Chevy & GMC Suburban, and 1969-72 Chevy Blazer/ GMC Jimmy
- Finished with black EDP protective coating to keep your new steel fresh and rust-free

110865	L/H - 1 Pc. / Bulk
110866	R/H - 1 Pc. / Bulk



110855

110854

Upper Door Hinge For 1973-87 Chevrolet Truck

- Die stamped with heavy duty steel with original contour detail
- Precision punched mounting holes for easy installation
- Features original style hinge spring to help keep the door open

110854	L/H - 1 Pc. / Bulk
110855	R/H - 1 Pc. / Bulk



110857

110856

Lower Door Hinge For 1973-87 Chevrolet Truck

- Die stamped with heavy duty steel with original contour detail
- Precision punched mounting holes for easy installation

110856	L/H - 1 Pc. / Bulk
110857	R/H - 1 Pc. / Bulk



Hood Hinge Spring For 1967-72 Chevrolet & GMC Truck

- Specially engineered to have the same yield and tensile strength as original
- Finish with black EDP protective coating
- Sold in pairs

110879 1 Pair / Bulk



Inner Grille Insert For 1971-72 Chevrolet Truck

- Excellent reproduction of the original
- Made of high impact, corrosion resistant ABS plastic
- Silver gray finish just like GM made them

110869 1 Pc. / Bulk



31 LED Red Sequential Tail Light W/Housing & Rim For 1928-31 Ford Car

- Super bright LED behind high quality red acrylic lens with fully sealed epoxy coated electronics
- Left hand includes 4 additional white LED with clear lens for license plate light
- Selector switch to control sequential function off, direction left, or direction right
- Also features a brake attention feature with a sequence - once function
- Fully assembled with highly polished stainless steel housing and bezel
- Recommended under dash flasher United Pacific 90652 (2-terminal) or 90651 (3-terminal)



(((BRAKE ATTENTION))) <<< SEQUENTIAL >>>
F · L · A · S · H

110890	Stainless Housing / Stainless Rim	L/H - 1 Pc. / Box
110891	Stainless Housing / Stainless Rim	R/H - 1 Pc. / Box
110892	Black Housing / Black Rim	L/H - 1 Pc. / Box
110893	Black Housing / Black Rim	R/H - 1 Pc. / Box
110894	Black Housing / Stainless Rim	L/H - 1 Pc. / Box
110895	Black Housing / Stainless Rim	R/H - 1 Pc. / Box



36443 **36444** **36445**

Plug & Play

High Power 8 LED 1157 Bulb

- 8 High Power SMD LED's, 80 lumens / 250 lumens
- Replaces most #1157 and #P21/5W applications
- 12 Volt, double contact with off-set pins

36443	White - 2 Pcs. / Color Box
36444	Red - 2 Pcs. / Color Box
36445	Amber - 2 Pcs. / Color Box



United Pacific LED Bulb Display

- Display approximate size: 16-3/4" X 6-1/4"
- Display includes item # 36543/36550/36920 /36931/36932/ 36934/ 36935/36918/38897/36443

99159	1 Pc. / Box
--------------	-------------



Heavy Duty Steering Wheel Spinner

- Fits 1-1/8" to 1-5/16" diameter steering wheel grips
- Heavy duty chrome die cast clamp
- Classic design intended to reduce effort and fatigue
- Includes 2 rubber spacers to accommodate different grip diameters
- Matching color steering wheel bezels, shift knobs, and air valve knobs available
- Not recommended for padded steering wheels

70362	Indigo Blue - 1 Pc. / Card
70363	Emerald Green - 1 Pc. / Card
70364	Cadmium Orange - 1 Pc. / Card
70365	Candy Red - 1 Pc. / Card
70366	Liquid Silver - 1 Pc. / Card
70367	Pearl White - 1 Pc. / Card
70368	Electric Yellow - 1 Pc. / Card



United Pacific, Long Beach Tee

- Great looking fatigue green color
- 100% preshrunk high-quality cotton
- TAGLESS for ultimate comfort
- Printed in the USA

99180M	Medium - 1 Pc. / Bulk
99180L	Large - 1 Pc. / Bulk
99180XL	XLarge - 1 Pc. / Bulk
99180XXL	XXLarge - 1 Pc. / Bulk



99187 **99188**



99189 **99190**

United Pacific 7" LED Headlight Display

- Attractive counter top display with interactive push buttons
- Ready to use, requires 110V outlet

99187	Display for 31459 - 1 Pc. / Box
99188	Display for 31496 - 1 Pc. / Box
99189	Display for 31513 - 1 Pc. / Box
99190	Display for 31084 - 1 Pc. / Box

PRODUCT INDEX

ITEM #	PAGE #	ITEM #	PAGE #	ITEM #	PAGE #	ITEM #	PAGE #	ITEM #	PAGE #
22974	12	99142	36	110760	18, 21	10352B	19	C8056	34, 38
22975	12	99159	41	110761	20	10353B	16	C8057	38
22976	12	99187	42	110762	20	34217B	16	C8061	34, 38
22977	12	99188	42	110763	18, 20	99129L	24	C8062	34, 38
31084	15	99189	42	110764	18, 20	99129M	24	CTL7073LED-L	33
31087	15	99190	42	110786	10	99129XL	24	CTL7073LED-R	33
31088	15	110092	29	110787	10	99129XXL	24		
31089	15	110094	27	110788	10	99179L	38		
33009	14	110099	33	110789	10	99179M	38		
33010	14	110100	33	110792	11	99179XL	38		
36443	41	110101	33	110793	11	99179XXL	38		
36444	41	110102	33	110794	8	99180L	42		
36445	41	110142	10	110795	20	99180M	42		
36449	32	110143	10	110803	39	99180XL	42		
36450	32	110194	37	110807	8	99180XXL	42		
36468	37	110195	37	110808	10	A8045	23		
36624	9	110196	29	110809	10	ACPU01	38		
38897	30	110197	29	110810	34	ANF1217	16		
38898	30	110198	37	110811	34	ANF1218	16		
38899	30	110294	39	110812	11	B20146	6		
46154	12	110295	39	110813	11	B20333	5		
46156	14	110296	39	110823	27	B20334	5		
46157	19	110297	39	110824	22	B21031	5		
52010	19	110359	17	110829	25	B21032	5		
70025	16	110360	17	110830	25	B21033	5		
70362	42	110375	33	110833	38	B21034	5		
70363	42	110376	33	110834	38	B21045	18		
70364	42	110377	33	110835	31, 38	B21052	6		
70365	42	110378	33	110836	31, 38	B21071	23		
70366	42	110379	33	110839	28	B21072	13		
70367	42	110380	33	110843	35	B21112	6		
70368	42	110382	39	110844	35	B21113	6		
70661	16	110415	21	110845	31	B21114	6		
70662	16	110416	21	110846	31	B21115	6		
70663	16	110486	7	110847	28	B21123	6		
70754	16	110499	29	110849	32	B21124	6		
70755	16	110513	26	110850	32	B21125-1	34		
70756	16	110536	7	110852	32	B21125-A	23		
70757	16	110587	35	110853	32	B21126-A	23		
70758	16	110590	7	110854	40	B21521	35		
70759	16	110591	26	110855	40	B24031	5		
70760	16	110592	26	110856	40	B24032	5		
70761	16	110593	26	110857	40	B24033	5		
70762	16	110594	26	110859	38	B24034	5		
70763	16	110596	34	110865	40	C4041	27		
70764	16	110626	34	110866	40	C4041L	27		
78027	36, 38	110627	34	110869	40	C5012G	35		
78028	38	110694	14	110872	34	C5013	35		
78029	38	110699	39	110873	34	C666702	17		
89997	14	110700	13	110879	40	C677204	36		
90649	17	110701	13	110890	41	C7001L	22		
99041	36	110710	11	110891	41	C7001L-1	22		
99053	24	110711	11	110892	41	C7001R	22		
99102	23	110716	30	110893	41	C7001R-1	22		
99121	12	110717	30	110894	41	C7031RL	21		
99122	12	110751	7	110895	41	C7031RLBD	22		
99135	19	110759	18	170473	8	C7031RR	21		
99136	29	110759	21	170474	8	C7031RRBD	22		





United Pacific

CLASSIC CAR & TRUCK

2020 New Product Collection



QUALITY

With over 30 years of experience in the automotive aftermarket industry, United Pacific Industries understands the rigors and stresses that our products are subjected to on the road. It is our mission to provide our customers with products of superior quality and reliability. In achieving this goal, United Pacific only partners with manufacturing facilities that conforms to our quality control requirements and standards. Our manufacturing partners meet or exceed ISO-9001 requirements. In addition, United Pacific's manufacturing partners must be equipped on site to perform the following quality assurance tests and maintain a track record of consistent quality and low product failure rate.

- Aging Test
- Air Tight Test
- Dust Test
- Flux Test
- Photometric Test
- Pull Force Test
- Rain Test
- Salt Spray Test
- Shock Test
- Temperature Test
- Humidity Test
- Vibration Test

Furthermore, our internal quality control structure allows us to function as the final quality control station prior to shipping. With the assistance of 3D computer technology, United Pacific can adhere to strict quality control standards during prototype creation and the production process. Our engineers and technicians perform a battery of tests to ensure that our products meet the demands of today's drivers and our goal to be first in quality.

INNOVATION

Known as the leader in innovation, United Pacific is dedicated to be the first to bring new and exciting products to the market. United Pacific's global expertise allows us to search the globe for new ideas and concepts. Not only do we search the globe for new products, United Pacific invest a significant amount of resources into our own research and development efforts. With the assistance of advance 3D scanning technology, our engineers and designers can acquire accurate and precise data in seconds.

The 3D data allows United Pacific to verify designs, perform quality assurance tests, and reverse engineer with unprecedented speed and accuracy. Digital inspection contributes to the early detection of shape problems, provides rapid feedback on design, and eliminates unnecessary work in downstream processes. Our rapid prototyping facility permits us to have a concept-to-shelf time of less than 5 months. In addition, United Pacific's 3D printing capabilities permit our designers to have physical models of their design concepts in hours. The physical models allow our designers and marketing staff to evaluate and test the viability of different design ideas. Our rapid prototyping facility allow United Pacific to compress design cycles, improve manufacturing planning, shorten concept-to-shelf time, most importantly, generate new and innovative products.

DESIGN

Located near some of the nation's most progressive automotive design centers, United Pacific established the UP Design Studio in 2002 to consolidate our position as the design leader in the automotive industry. UP Design Studio utilizes the latest generation of computer aided design (CAD) and studio/graphic software. The design studio is equipped with the newest computers and rapid prototyping systems. In addition, UP Design Studio is staffed by graduates from the nation's most prestigious design colleges. Unlike our competitors, United Pacific's design and manufacturing capabilities mean that we carry more new and original items than our competitors. The establishment of the design studio will enable us to generate even more new products with significant shorter concept-to-shelf time. The reduction in development cost mean that we can develop products utilizing design based development processes. Design based product development allows United Pacific to create new product concepts based on designs incorporating driver demands and needs instead of economic considerations. United Pacific's emphasis on design distinguishes and positions us ahead of our competitors.



WARRANTY

With LED (Light Emitting Diodes) rated at 100,000 hours of operation and solid-state construction, United Pacific's LED lights are extremely reliable and durable. Purchase with confidence, United Pacific offers a complete line of LED lighting products with extended or limited lifetime warranties. Please see the warranty policy page for more details.

INVENTORY AND SHIPPING

United Pacific carries over 20,000 items in our California distribution center. No other company in the heavy duty trucking industry can match United Pacific in the variety and range of in-stock inventories. With an order fill rate of over 98.5%, United Pacific is the largest and most reliable supplier in the industry. Our shipping department ships 96.8% of all orders within 24 hours and 98.9% within 48 hours. United Pacific's vast inventory and prompt shipping has made United Pacific the only source for our customer's chrome and lighting needs.



HARD AT WORK FOR THE ENVIRONMENT



United Pacific
132,000 sq ft
Distribution Center
Long Beach, CA

100% reduction in potable water used for landscaping

40% reduction in total energy use due to high-efficiency mechanical and lighting systems

82% of construction waste was diverted from landfills

LEED ACCOMPLISHMENTS

Sustainable Sites

- On-site bicycle storage, showers and changing areas for company employees.
- Preferred parking for low-emitting, fuel-efficient and carpool vehicles.
- Storm water is infiltrated on-site and treated to remove contaminants to reduce environmental impact on local waterways.

Water Efficiency

- In addition to using reclaimed water, drought-tolerant plants and a high-efficiency irrigation system were installed to reduce the use of potable water for irrigation by 100%.

Energy and Atmosphere

- Efficient HVAC equipment and a lighting system with daylight controls reduces energy consumption by over 30%.
- Enhanced commission verifies that the building's energy and water-related systems are performing as intended by the initial design.

Indoor Environmental Quality

- Building ventilation systems was designed to provide enhanced levels of fresh outside air to building occupants.
- Interior finishes (plants, sealants, adhesives, coatings, carpet systems and composite wood) were selected with low levels of volatile organic compounds (VOCs) to reduce indoor air contamination.



NEW ITEMS

January 2020

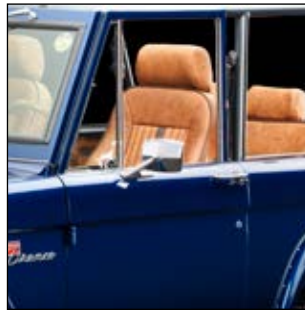

Chrome Exterior Mirror For 1966-77 Ford Bronco & 1967-79 Truck

- Exceptional quality die cast metal and beautifully chrome plated
- Available with special behind-the-mirror LED design, hidden when not in use
- Convex mirror for wide angle visibility for R/H side
- Includes mounting pad and screws

110735 Fits L/H or R/H - 1 Pc. / Color Box

110736 L/H w/LED Turn Signal - 1 Pc. / Color Box

110737 R/H w/Convex Mirror - 1 Pc. / Color Box

110738 R/H w/Convex Mirror &LED Turn Signal - 1 Pc. / Color Box



Chrome Plated Grille Without Lettering For 1969-77 Ford Bronco

- Die stamped with high quality 17 gauge sheet metal
- Features original contour, detail and mounting brackets for the larger turn signal lights
- Smooth center bar design without FORD letters to keep that clean front end look
- Beautiful show ready chrome plated finish
- Headlight adjusters also included for easy headlight installation and adjustment

110516 1 Pc. / Box





Aluminum Grille Shell Without Insert For 1971-72 Chevrolet Truck

- Stamped aluminum with highly polished and anodized finish
- Features all the original contour and headlight mounting holes
- Fits 1971-72 Chevy Truck, Blazer, and Suburban
- Inner grille insert available separately, UP# 110869

110868 1 Pc. / Box



Hood Hinge & Support For 1947-55 Chevy & GMC Truck 1st Series

- Heavy duty steel reproduction of the original hood hinge style and design
- Fits 1947-55 Chevy & GMC 1st series truck
- Includes hood support arm with clock spring
- Zinc plated finish for better corrosion resistance
- Includes (3) OE style shoulder bolts for proper installation

110249 L/H - 1 Set / Box

110250 R/H - 1 Set / Box



Hood Hinge For 1967-72 Chevrolet & GMC Truck

- Heavy duty steel reproduction of the original hood hinge style and design
- Finish with black EDP protective coating to keep your new steel fresh and rust-free
- Springs available separately, UP#110879

110877 L/H - 1 Pc. / Bulk

110878 R/H - 1 Pc. / Bulk



Cab Mount Kit For 1955-59 Chevy Truck

- Quality molded rubber cab mounts
- Includes all mounting bolts, lock nuts, spacers and large washers
- 22 piece kit
- Includes installation diagram

110842 1 Set / Box

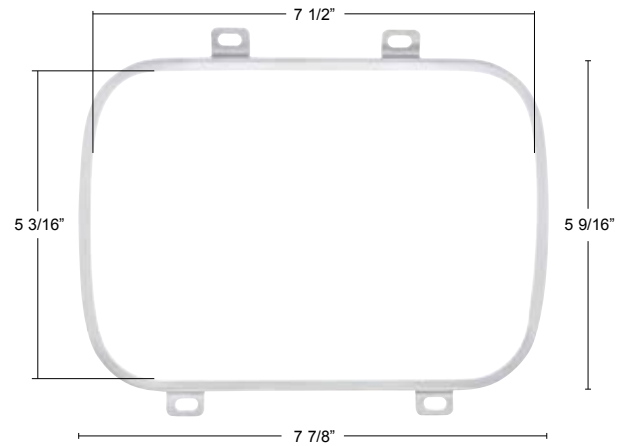

Stainless Steel 5" X 7" Headlight Retaining Ring

- 304 Stainless steel with 4 screw tabs
- Check measurements for your application
- Sold each

30610B 1 Pc. / Bulk



36454



36455



36456



36457

4.5" 24 High Power LED Work Light With "X" Light Guide

- High power SPOT & FLOOD beam combination work light with unique 15 LED "X" light guide design
- Water resistant die cast housing, polycarbonate lens provides maximum protection & durability
- Solid state design resists shock and vibration
- 5200 lumens, IP 67 water resistant
- 12VDC - 24VDC

36454 Amber - 1 Pc. / Color Box

36455 Blue - 1 Pc. / Color Box

36456 Red - 1 Pc. / Color Box

36457 White - 1 Pc. / Color Box

⊗ Light Guide High Power LED Front Spot Light



High Power LED Front Flood Light



NEW ITEMS

February 2020



Round Exterior Mirror For 1966-72 Chevy Passenger Car

- Exceptional quality die cast metal and beautifully chrome plated with Chevy bowtie logo
- Available with special behind-the-mirror LED design, hidden when not in use
- Convex mirror for wide angle visibility for R/H side
- Includes mounting pad and screws
- Officially licensed GM restoration part

C687201 Fits L/H or R/H - 1 Pc. / Color Box

110826 R/H w/Convex Mirror &LED Turn Signal - 1 Pc. / Color Box

110827 R/H w/Convex Mirror - 1 Pc. / Color Box

110825 L/H w/LED Turn Signal - 1 Pc. / Color Box



One-Piece Style LED Tail Light For 1955 Chevy Car

- 48 SMD super bright LED with high quality all red polycarbonate lens
- Custom style one-piece design with backup light deleted
- Direct plug & play installation with 1157 type connector
- Electronics completely sealed in epoxy to resist corrosion and moisture
- Solid state circuit board engineered for any 12VDC system

110206 1 Pc. / Card



LED Side Marker For 1970-77 Ford Bronco

- 8 LED Dual function, parking light and turn signal
- Super bright amber LED with amber or red acrylic lens
- Epoxy coated, fully sealed electronics
- Fits left hand and right hand

110804 Front LED Side Marker - Amber - 1 Pc. / Card

110805 Rear LED Side Marker - Red - 1 Pc. / Card



289/302/351W Long Tube Headers For 1966-77 Bronco

- Fits all 1966-77 Broncos with a 289, 302, or 351W V8 engine
- Extra-thick 16 gauge 1 1/2" mandrel-bent tube
- 3/8" thick laser cut flanges resist warping
- Designed to provide ample clearance for tight areas
- Long tube design delivers maximum horsepower and torque

110588 Black - 1 Set / Box

110589 Silver Ceramic Coated - 1 Set / Box



Plain Style Tailgate Without Ford Letters For 1966-77 Ford Bronco

- High quality heavy 16 gauge steel aftermarket reproduction of the original Ford tailgate
- Precision cut latch handle pocket with 1/4"-20 welded nuts and recessed mounting holes on the inside panel
- Includes tailgate linkage posts, tailgate trunnion pockets, and latch pockets with 5/16"-18 threaded holes
- Features license plate light pocket, wiring holes, and small 0.087" diameter mounting holes
- Finished with black EDP protective coating to keep your new steel fresh and rust-free

110884 1 Pc. / Box



Chrome Interior Dome Light Assembly For 1960-72 Chevy/GMC Truck & Suburban

- Chrome plastic housing with lens, 12V light bulb, 143" OE style wiring harness and plug connector

110876 1 Pc. / Box



Rear Inner Wheelhouse For 1967-72 Chevrolet Fleetside Truck

- Excellent 18 gauge steel reproduction of the OE style wheelhouse
- Features all original curvature and mounting pattern
- Finished with black EDP protective coating to keep your new steel fresh and rust-free
- Fits lefthand or righthand side, two required for each truck
- Fits 1967-72 Chevrolet/GMC Fleetside Truck, 67-72 Chevrolet Blazer and 70-72 GMC Jimmy

110867 1 Pc. / Bulk



Sitting Pig Ornament

- Detailed die-casting with beautiful chrome plating
- Easy installation on any vehicle with three mounting studs
- Approximately 5-1/2" x 3-1/2" x 4-1/2"
- Mounting pad and hardware included
- Perfect decorator item for home, office and man cave

72046 Chrome - 1 Pc. / Color Box

72047 Black - 1 Pc. / Color Box



Cab Mount Kit For 1960-66 Chevy Truck

- Quality molded rubber cab mounts
- Includes all mounting bolts, lock nuts, spacers and large washers
- 28 piece kit

110860 1 Set / Box



110863



110864

Stainless Steel Flag Holder with Flags

- Stainless flag holder with flags
- Show your patriotism

110863 3 Flags - 1 Set / Card

110864 5 Flags - 1 Set / Card



110861

110862

Stainless Steel Flag Holder

- Stainless flag holder only
- Fits United Pacific U.S.A. flag item No. C9003

110861 3 Post - 1 Pc. / Bulk

110862 5 Post - 1 Pc. / Bulk

NEW ITEMS

March 2020



One-Piece Style Sequential LED Tail Light For 1955 Chevy Car

- 48 SMD super bright LED with high quality all red polycarbonate lens
- Custom style one-piece design with backup light deleted
- Features sequential function with selector switch to control sequential function off, direction left, or direction right
- Also features brake attention option with sequence-once function
- Direct plug & play installation with 1157 type connector
- Electronics completely sealed in epoxy to resist corrosion and moisture
- Solid state circuit board engineered for any 12VDC system
- Recommend to upgrade under dash flasher to item no. 90652 or 90649 LED flasher
- Recommend license plate with LED back-up light, item no. 50187



(((BRAKE ATTENTION)))

(((SEQUENTIAL F.L.A.S.H)))



110207

1 Pc. / Card



Chrome 1929-39 California License Plate Frame

- For Vintage 1929-39 California license plates w/ sharper corners
- High quality stamped steel with chrome plating

50088 1 Pc. / Card



Chrome 1940-55 California License Plate Frame

- For Vintage 1940-55 California license plates w/ rounded corners
- High quality stamped steel with chrome plating

50089 1 Pc. / Card



Rear Fuel Tank Strap For 1966-76 Ford Bronco

- Made of high-quality galvanized stamped steel
- Black EDP coated to keep your new steel fresh and rust-free
- J-bolt included for proper installation

110806 1 Pc. / Bulk

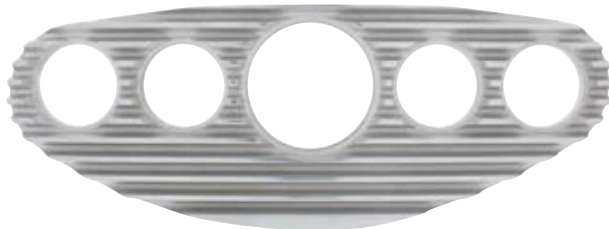

110480

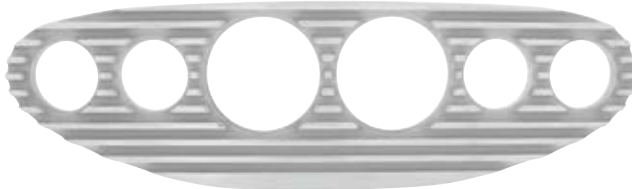

110481



Finned Style Aluminum Dash Panel

- Cast with aluminum and CNC finished faces
- Finned style design
- Four outer holes with 2-1/16" inside diameter
- Two pre-tapped #6-32 holes for straight forward installation

110480 Five Hole - 1 Pc. / Box

110481 Six Hole - 1 Pc. / Box



Chrome "Bel-Air" Script Emblem For 1955-56 Chevy Bel-Air

- Fits rear quarter panel, duplicate of original
- Beautiful chrome plated with triple chrome plating process
- Includes mounting clips
- GM restoration licensed product

C555601 1 Pc. / Bulk



COMPETITION
SERIES

2 White LED Chrome License Plate Light/Utility Light - Competition Series

- Super bright white LED utility/license light, 12 volt
- Chrome housing, water resistant
- Includes mounting pad & screws

39909 1 Pc. / Card



99193



99194



99195

United Pacific Work Light Display

- Polished stainless steel display base
- Completely assembled and wired
- 12 Volt power supply included

99193 36671/36672/36507/36965 - 1 Pc. / Box

99194 36461/36462/36506/36965 - 1 Pc. / Box

99195 36463/36464/36506/36965 - 1 Pc. / Box

NEW ITEMS

April 2020



Super bright white LED cargo bed floor illumination



Integrated LED 3rd Brake Light



LED Cargo Light Assembly For 1969-72 Chevy & GMC Truck

- Super bright LED cargo light assembly with integrated LED 3rd brake light
- High quality heavy chrome plated die-cast housing
- Includes large rubber mounting pad, socket, lens gasket, lens screws and housing to cab mounting spacers

110147 1 Pc. / Color Box



Incandescent Cargo Light Assembly For 1969-72 Chevy & GMC Truck

- Complete original style incandescent cargo light assembly with 1004 bulb
- High quality heavy chrome plated die-cast housing
- Includes large rubber mounting pad, socket, lens gasket, lens screws and housing to cab mounting spacers

110446 1 Pc. / Color Box



110149



110217



110168



39065



110148

110149 Mounting Pad - 1 Pc. / Bulk

110217 Lens Gasket - 1 Pc. / Bulk

110168 Lens - 1 Pc. / Card

39065 1004 Type Bulb - 1 Pc. / Bulk

110148 1004 Chrome Housing with Gasket - 1 Pc. / Color Box





LED Sequential Turn Signal



24 High Power LED 7" Light With Dual Color Position Light

- 24 LED high power 7" light with 8 dual color LED position light
- LED white/amber position light bar changes from white to amber when sequential light is activated
- Sequential amber position light can be connected for lefthand or righthand operation
- High beam: 5000 Lumens; Low beam: 2000 lumens; Position light-white: 200 lumens; Position light-amber: 125 lumens
- Easy connection, plugs into existing wiring harness, position light requires additional wiring. Installation in some OE light housings may require modification
- For off-road use only

Technical Specification	
Low Beam Application	High Beam Application
2000 Lumens	5000 Lumens
6000-6500K	6000-6500K
12VDC - 24VDC input	12VDC - 24VDC input





36452 1 Pc. / Color Box



Antique New Item Flyer Collection

- ANF1219** 2019 New IItem Flyer Collection - 48 pages, high gloss, 4 color, perfect bound catalog - 1 Pc. / Bulk
- ANF1218** 2018 New IItem Flyer Collection - 82 pages, high gloss, 4 color, perfect bound catalog - 1 Pc. / Bulk
- ANF1217** 2017 New IItem Flyer Collection - 62 pages, high gloss, 4 color, perfect bound catalog - 1 Pc. / Bulk
- ANF1216** 2016 New IItem Flyer Collection - 64 pages, high gloss, 4 color, perfect bound catalog - 1 Pc. / Bulk
- ANF1215** 2015 New IItem Flyer Collection - 174 pages, high gloss, 4 color, perfect bound catalog - 1 Pc. / Bulk

NEW ITEMS

May 2020



110837



110838

Anodized Billet Aluminum Turn Signal Bezel Set For 1969-77 Ford Bronco

- Beautifully CNC milled from billet aluminum
- Durable anodized finish to increase corrosion resistance while keeping the machined finished look
- Mounts between the front turn signal bucket and the grille
- Includes mounting gaskets
- Sold in pairs



Aluminum Bezel, Gasket Included

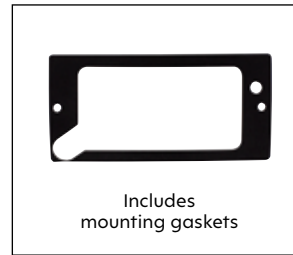

Includes mounting gaskets



110837 Clear Anodized Finish - 1 Set / Color Box

110838 Black Anodized Finish - 1 Set / Color Box



Bed Front Panel For 1967-72 Chevrolet & GMC Fleetside Truck With Steel Bed Floor

- Quality die stamped steel reproduction with 16 gauge steel
- Plain smooth style panel design
- OE style rolled over top flange with 1/4"-20 welded square nuts
- Precision punched bed side panel mounting holes
- Bottom flange made to match OE specification for use with steel bed floor

110896 1 Pc. / Box



23497



23498



23499

Chrome Thread-on Shift Knob

- High quality die-cast aluminum with triple chrome plating
- Inside thread 1/2"-13
- Made for vehicles with 1/2-13 threaded shifters. Great custom item for Rat Rods, Broncos & C10's. Adapters not included
- May also work for other vehicles with 1/2"-13 thread

23497 Skull - 1 Pc. / Card

23498 Ace of Spades - 1 Pc. / Card

23499 Eagle - 1 Pc. / Card



NEW & IMPROVED

NEW & IMPROVED

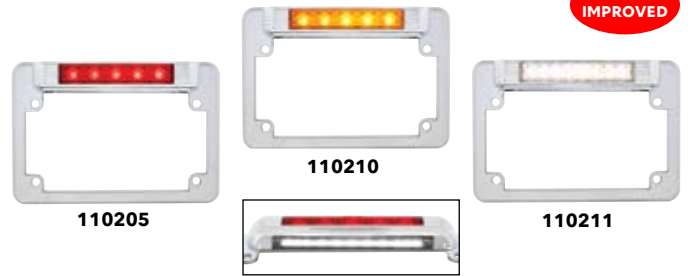

Chrome License Plate Light

- New and improved with SMD LED's for more lumen output, better heat dissipation, longer life
- Beautiful chrome die cast metal light housing with 5 LED light, and 11 LED license plate light
- Mounts to any surface with 2 mounting studs on back, 5-1/2" center-to-center
- Includes mounting pad with lip and mounting hardware.

- 110203** Red LED - 1 Pc. / Card
- 110204** White LED - 1 Pc. / Card
- 110265** Amber LED - 1 Pc. / Card

Chrome Motorcycle License Plate Frame w/ LED Light

- New and improved with SMD LED's for more lumen output, better heat dissipation, longer life
- Beautiful chrome die cast metal light housing with 5 LED light, and 11 LED license plate light
- Fits standard U.S. motorcycle license plates

- 110205** Red LED - 1 Pc. / Card
- 110210** Amber LED - 1 Pc. / Card
- 110211** White LED - 1 Pc. / Card

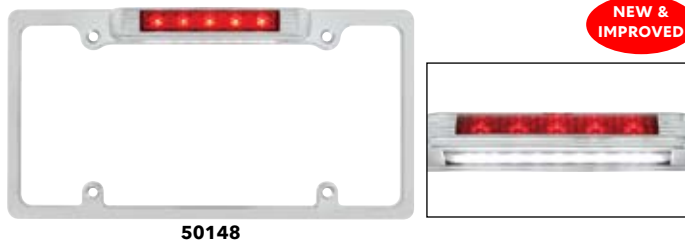

NEW & IMPROVED

NEW & IMPROVED

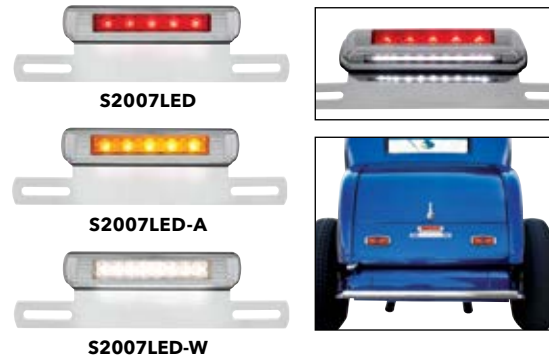

Chrome License Plate Frame w/ Auxiliary Light

- New and improved with SMD LED's for more lumen output, better heat dissipation, longer life
- Beautiful chrome die cast metal light housing with 5 LED light, and 11 LED license plate light
- Fits standard U.S. & Canadian 6" X 12" license plates
- Overall frame dimension 12-5/16" X 6-3/8"

- 50148** Red LED - 1 Pc. / Card
- 50149** Amber LED - 1 Pc. / Card
- 50187** White LED - 1 Pc. / Card

Chrome Motorcycle License Plate Frame w/ LED Light

- New and improved with SMD LED's for more lumen output, better heat dissipation, longer life
- Beautiful chrome die cast metal light housing with 5 LED light, and 11 LED license plate light
- Mounts to any surface with 2 mounting studs on back, 5-1/2" center-to-center

- S2007LED** Red LED - 1 Pc. / Card
- S2007LED-A** Amber LED - 1 Pc. / Card
- S2007LED-W** White LED - 1 Pc. / Card



United Pacific Light Display - 7", 5-3/4", 4"x6", 5"x7"

- Quality point-of-purchase display made of steel and gloss black powder coated
- Includes United Pacific items: 31084, 31267, 34125, 31087
- Includes 12V power supply unit & wall plug
- Completely assembled and wired
- Display approximate size: 33-3/4" L X 12-3/4" W X 4 -1/2" H

- 99196** 1 Pc. / Box

NEW ITEMS

June 2020



110772



110773



Anodized Billet Aluminum Side Marker Bezel w/ Raised Side Protection For 1970-77 Ford Bronco

- Beautifully CNC milled from billet aluminum
- Durable clear anodized finish to increase corrosion resistance while keeping the machined finished look
- Includes two stainless steel screws and mounting gasket
- Also fits 1970-74 Econoline, and rear only on 1970-72 F100, F150, & F250
- Sold each

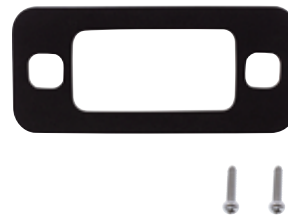

110772 Clear Anodized Finish - 1 Pc. / Color Box

110773 Black Anodized Finish - 1 Pc. / Color Box



110774



110775



Anodized Billet Aluminum Side Marker Light Bezel For 1970-77 Ford Bronco

- Beautifully CNC milled from billet aluminum
- Durable clear anodized finish to increase corrosion resistance while keeping the machined finished look
- Includes two stainless steel screws and mounting gasket
- Also fits 1970-74 Econoline, and rear only on 1970-72 F100, F150, & F250
- Sold each

110774 Clear Anodized Finish - 1 Pc. / Color Box

110775 Black Anodized Finish - 1 Pc. / Color Box

HOT ITEM

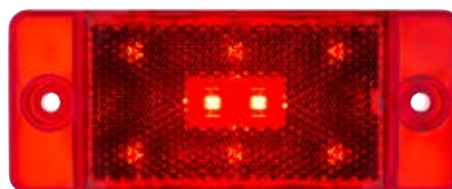
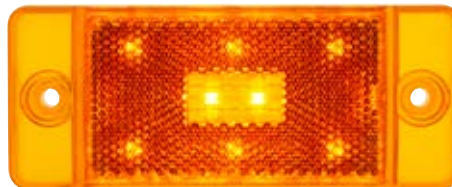

LED Side Marker For 1970-77 Ford Bronco

- 8 LED Dual function, parking light and turn signal
- Super bright amber LED with amber or red acrylic lens
- Epoxy coated, fully sealed electronics
- Fits left hand and right hand

110804 Front LED Side Marker - Amber - 1 Pc. / Card

110805 Rear LED Side Marker - Red - 1 Pc. / Card



110776



110777



Anodized Billet Aluminum Steering Column Cover For 1966-77 Ford Bronco

- Beautifully CNC milled from billet aluminum
- Upgrades the original plastic steering column cover to heavy duty billet aluminum
- Durable clear anodized finish to increase corrosion resistance while keeping the machined finished look
- Two-piece design for easy installation

110776 Clear Anodized Finish - 1 Pc. / Card

110777 Black Anodized Finish - 1 Pc. / Card

**New Upgraded
Slim Low Profile Design**



36446

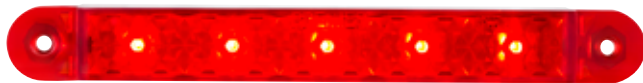

36447

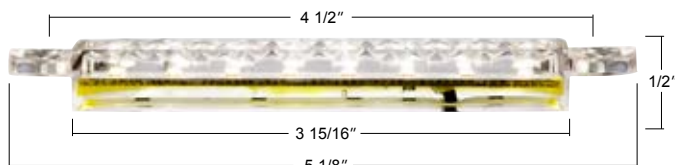

36448

5" SMD LED Light Strip With Hard Wire

- 5 Super bright SMD LED strip with fully sealed electronics
- 12VDC, available in dual function red or amber, or single function white
- Captive #6-32 nuts for rear flush mounted installation
- For clean and proper mounting, a 3-15/16 X 5/8" rectangular pocket is required
- See "Attachment-Line Art" for more dimensional details

36446 Amber LED - 1 Pc. / Card

36447 Red LED - 1 Pc. / Card

36448 White LED - 1 Pc. / Card



Tire Checker Bat

- United Pacific 17" aluminum tire checker

99060 1 Pc. / Bulk

NEW ITEMS

July 2020



110871



110870



Anodized Aluminum Headlight Bezel For 1969-72

- Quality stamped 24 gauge aluminum with rolled edges
- Beautiful clear anodized finish

110870 L/H - 1 Pc. / Box

110871 R/H - 1 Pc. / Box



Stainless Steel Hood Spring For 1967-72 Chevrolet & GMC Truck (Pair)

- Specially engineered to have the same yield and tensile strength as original
- Corrosion resistant stainless steel, with a bright electropolished satin finish
- Sold in pairs

110899 1 Pair / Bulk



Glove Box Lock Cylinder w/Keys For 1947-53 Chevy/GMC Truck

- Quality reproduction of original style lock cylinder
- Includes 2 keys with GM marking
- Official GM licensed restoration product

110888 1 Pc. / Bulk



Door Lock Cylinder W/Keys For 1947-51 Chevy/GMC Truck

- Outside door lock cylinder with 2 keys
- Official GM licensed restoration product

110887 1 Pc. / Bulk



Stellar Pluto+ Duo Bundle Headset

- A Trucker’s “best friend” headset offering battery life for longest talk time, best comfort, unique style and quality sound
- “Pluto” mode is single earpiece and 30 hours of talk time / 500 hours of stand-by time
- “Duo” mode adds a stereo earpiece for 60 hours of talk time / 900 hours stand-by time
- “Duo” earpiece is also a USB power bank to charge other devices on the go
- Noise Armor® technology offers the best noise cancellation for truckers. No more “I can’t hear”
- Bluetooth 5.0 compatible, and has longer range and more connectivity for your devices
- Durable carrying case, dual USB car charger, and USB cable included

95002 1 Set / Box

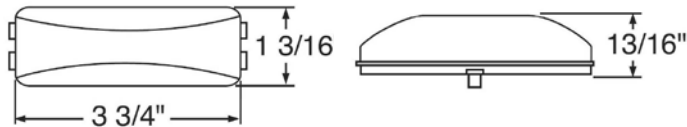

Incandescent Rectangular Fender Mount Clearance /Marker Light - Amber & Red Lens

- Functions as both front and rear clearance light for trailers over 80 inches wide
- High quality injection molded dual color, amber and red plastic lens
- Polycarbonate lens sonically sealed to housing to prevent moisture intrusion
- Grease filled terminals to prevent corrosion
- Recommend mounting/quick-connect base: item # 30919 (chrome) or item # 33006 (black)

31050 1 Pc. / Bulk



1966-77 Ford Bronco Catalog - 2nd Edition

- 54 pages, high gloss 4 color printing with UV coated cover
- 2nd Edition

ACBR02 1 Pc. / Bulk

NEW ITEMS

August 2020



34131



34132



34133



34134

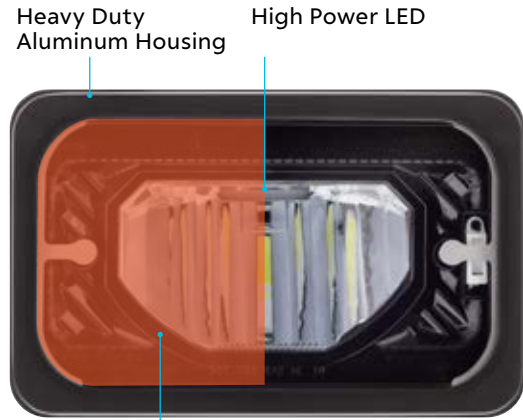

Heavy Duty Aluminum Housing

High Power LED

Electrical Heating System
Automatic De-ices the Headlight According to Ambient Temperature



100% LED

DOT

4" X 6" Heated LED Headlight

- Features a heating system that automatically de-ices the headlight according to ambient temperature
- Durable glass lens with heavy duty aluminum housing
- Plug & play with standard H4 style connector plug for ease of installation
- Available in high beam and low beam with choice of chrome or black inner liner
- Low beam: 1000 lumens, high beam: 1200 lumens, 12-24VDC, 20 watts

34131	Chrome	Low Beam - 1 Pc. / Color Box
34132	Chrome	High Beam - 1 Pc. / Color Box
34133	Black	Low Beam - 1 Pc. / Color Box
34134	Black	High Beam - 1 Pc. / Color Box

Technical Specification

Low Beam Application
1000 Lumens
12VDC - 24VDC Input
20 Watts

High Beam Application
1200 Lumens
12VDC - 24VDC Input
24 Watts



Dash Bezel For 1969-72 Chevy/GMC Truck With 7 Gauges - Black & Chrome

- High quality plastic injection molded reproduction of the original
- Beautiful chrome plated outer trim with black painted inner face
- Feature original mounting pattern with mounting posts for easy installation

110697 1 Pc. / Box



110897

110898



UP# 110899
Available Separately

Chrome Hood Hinge For 1967-72 Chevrolet & GMC Truck

- Heavy duty steel reproduction of the original hood hinge style and design
- Beautifully chrome plated with triple chrome plating process
- Stainless steel springs available separately, UP#110899

110897 L/H - 1 Pc. / Box

110898 R/H - 1 Pc. / Box



Bed Front Panel For 1932-37 Ford Truck

- Die stamped with high quality 16 gauge sheet metal
- Features original style stiffening ribs and square-shape top edge
- Finished with black EDP protective coating to keep your new steel fresh and rust-free

B21507 1 Pc. / Box



Black Arm Rest For 1968-77 Ford Bronco (Pair)

- Perfect for replacing that wore out arm rest on an early Bronco
- High quality synthetic leather in black finish
- Mounting pocket w/ original mounting pattern for easy replacement

110840 1 Pair / Box



Primer Finished Outside Sunvisor For 1955-59 Chevy Passenger Car

- Excellent reproduction with original detail
- Features precision punched mounting holes and center reinforcement brace
- Ready for paint with primer finished coating

C7016 1 Pc. / Bulk



Remote Exterior Mirror Kit For 1964.5 -66 Ford Mustang

- Beautiful die-cast and chrome plated exactly as original
- Features remote linkage with handle and mounting plate
- Includes mounting pad and screws

F646605 L/H - 1 Pc. / Box

F646606 R/H - 1 Pc. / Box



United Pacific Cap - Camo U.P. Cap

- 100% cotton twill cap

99086 1 Pc. / Bulk

NEW ITEMS

September 2020

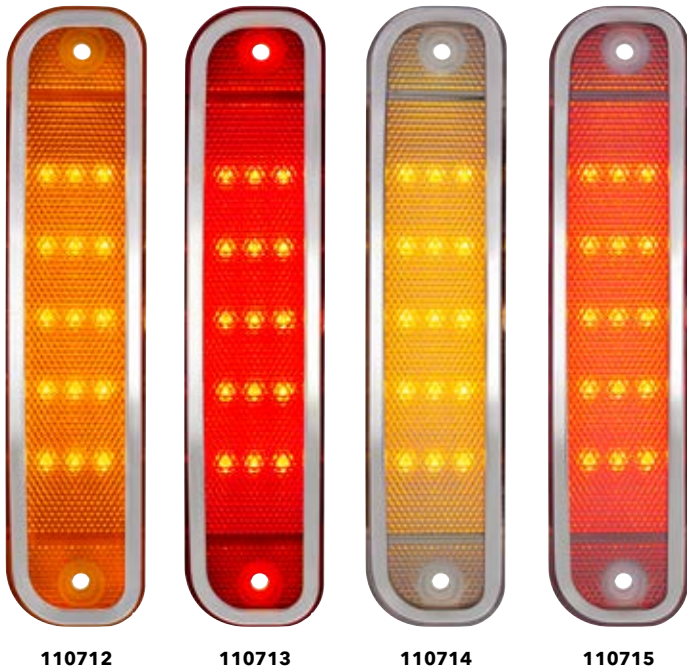

15 LED Side Marker Light With Stainless Steel Trim For 1973-80 Chevrolet Truck

- Super bright LED with high quality injection molded acrylic lens
- Dual function, parking light and turn signal
- Polished stainless steel deluxe style trim
- Epoxy coated, fully sealed electronics
- Also fits 1973-91 Chevy & GMC dually rear

110712	Amber LED/Amber Lens - 1 Pc. / Card
110713	Red LED/Red Lens - 1 Pc. / Card
110714	Amber LED/Clear Lens - 1 Pc. / Card
110715	Red LED/Clear Lens - 1 Pc. / Card



3 Candle Power 6V Parking Light Bulb For 1928-48 Ford Car & Truck

- #63 style, 6 volt, single contact with BA15s base
- Typically used on early Fords for cowl lights, parking lights, dash lights

A1068 1 Pc. / Bulk



Black Powder Coated Magnetic Pipe Holder With Felt Liner

- No-Scratch felt lining
- Strong magnetic securely sticks to any metal dashboard
- Keep pipe within easy reach

C5016 1 Pc. / Color Box

NEW ITEMS

October 2020



Titan Cap™

Locking Gas Cap for 1947-71 Chevy and Ford

- Top quality rugged all metal military style fuel cap design
- Fits 1947-71 Chevy & GMC trucks, 1949-70 Ford cars, 1957-70 Ford trucks & Bronco
- Great for off-road enthusiasts who value extreme-armor designs and fitments
- Available in chrome plated or matte black painted finish
- Vented gas cap for vented fuel systems only

110874 Chrome - 1 Pc. / Card

110875 Black - 1 Pc. / Card

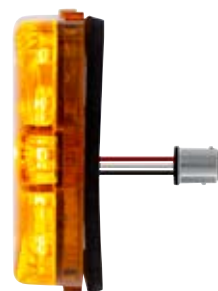
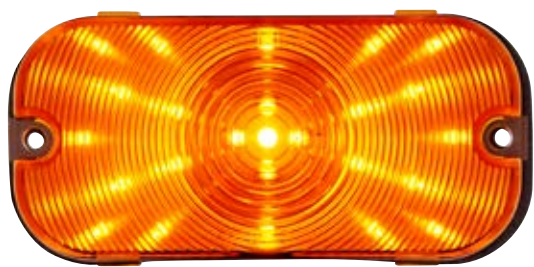

25 LED Parking/Signal Light For 1966-68 Ford Bronco

- LED Dual function, parking light and turn signal
- Super bright amber LED with amber acrylic lens
- Epoxy coated, fully sealed electronics, 1157 plug
- Fits left hand and right hand
- Gasket included

110858 1 Pc. / Card





Stainless Steel Fender Skirt Scuff Pads For 1956 Chevy Passenger Car (Pair)

- Made of top grade, rust free, T304 stainless steel
- Highly polished to a mirror like shine

C1007 1 Pair / Bulk



Stainless Steel Fender Skirt Scuff Pads For 1959 Chevy Passenger Car (Pair)

- Made of top grade, rust free, T304 stainless steel
- Highly polished to a mirror like shine

C1009 1 Pair / Bulk



Chrome Skull Shift Linkage For Harley

- Unique 3D skull design with triple chrome plating for a lasting show-bike shine
- High quality adjustable rod end ball joints to ensure smooth operation
- Includes a straight transmission lever cover and decorative acorn nuts and bolts. (Note: cover does not fit 2017+ Milwaukee-Eight with curved trans lever)
- Complete the look with Skull Swing Arm Insert Set, UP# 52010
- Fits 1986+Harley Softtail (except 18+ FXBB and FXLR), Touring and Trike models. (Does not fit 97- 99 FLSTS or models equipped with Softail Extended Reach Forward Controls.)

52009 1 Pc. / Card



Chrome Skull Swing Arm Accent Set For Harley

- Fits 2008-17 Harley-Davidson Softtail models (except FXCW, FXCWC, FXSB, and FXSBSE)
- Unique four-piece skull accent set to dress up the recessed area in the rear swing arm frame
- Easy to install with pressure sensitive adhesive mounting
- Beautifully chrome plated plastic injection molded
- Add a little attitude to your ride

52010 1 Set / Card

NEW ITEMS

November 2020



B20331



B20332



B20330 - Front Fender Brace

Steel Front Fender For 1932 Ford Car & Truck

- Quality stamped steel, exactly as original Henry!
- Fender edge bead with steel inner wire as original
- Finished with black EDP protective coating to keep your new steel fresh and rust-free
- Fits all 1932 Ford vehicles including 1932 Truck. However, fender does NOT have spare tire well.
- Available in left hand or right hand applications

B20331 L/H - 1 Pc. / Box

B20332 R/H - 1 Pc. / Box



B20333



B20334

Rear Fender for 1932 Ford 5W Coupe & Roadster

- Quality stamped steel, exactly as original Henry!
- Made of excellent 20 gauge sheetmetal
- Fender edge bead with steel inner wire as original
- Precision punched quarter panel mounting holes
- Includes mounting holes for frame horn cover
- Coated with black EDP
- Sold individually, please specify left or right hand side

B20333 L/H - 1 Pc. / Box

B20334 R/H - 1 Pc. / Box





Stainless Steel Bumper End Bolts And Nuts For 1928-31 Ford Model A (Pair)

- Beautiful quality stainless steel
- Exact shape and size as the original
- 5-1/8" partial threaded with 1" long 7/16"-20 threads
- Feature original style anti-rotation key design under the head of the bolt

A6219 1 Pair / Bulk



Stainless Steel Bumper Bar Spacer For 1928-31 Ford Model A (Pair)

- Highly polished stainless steel
- A spacer between 2 bumper bars

A6220 1 Pair / Bulk



Highly Detailed Bassett Hound Ornament

- Detailed die-casting with beautiful chrome plating or matte black powder coated finish
- Easy installation on any vehicle with four mounting studs
- Approximately 7-5/8" x 4-1/8" x 7-1/4"
- Mounting hardware included
- Ideal for decorating small and personal space, home, office and garage

72003 Chrome - 1 Pc. / Color Box

72053 Black - 1 Pc. / Color Box



Cab Mount Kit For 1949-54 Chevy And GMC Truck

- Complete cab mounting kit with fasteners
- Features heavy duty reinforced rubber square pad and mounting fasteners for front cab installation
- Quality molded rubber bushing for the rear cab mount shackles
- 18 piece kit
- Includes installation diagram

110841 1 Set / Bulk



19" Double Contact Pigtail

- 18 AWG thermoplastic jacketed wires
- Tinned copper wires for better corrosion resistance
- Nylon insulation plate

A1060-4 1 Pc. / Bulk

Heated LED Headlights with Polycarbonate Lens & Housing

Available Mid-November





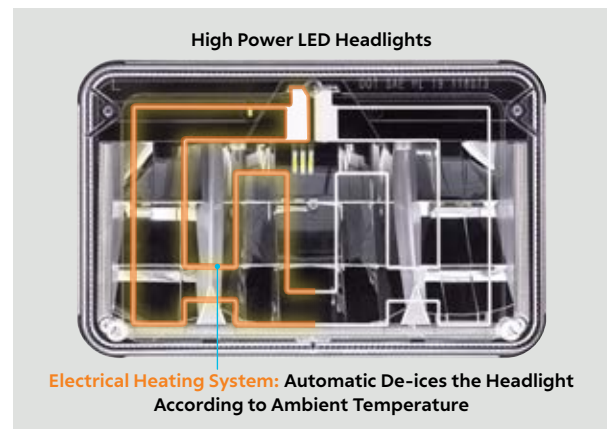

- Features a heating system that automatically de-ices and defrosts the headlight lens when outside temperature reaches 50 degrees Fahrenheit (10 Celsius) or below
- Integrated monitoring system to turn off heating when snow & ice has cleared from lens
- Durable corrosion resistant polycarbonate lens, housing & electronics resist shock and vibration
- Plug & play with standard H4 style connector plug for ease of installation



100%LED



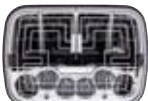

DOT

Technical Specs

Item	Size	Beam	Lumens	Color Temp.	Voltage	Unit / Box
 34135	 34136					
34135	4" x 6"	Low	750	6500 kelvin	12v/24v	1 Pc. / Card
34136	4" x 6"	High	1000	6500 kelvin	12v/24v	1 Pc. / Card
 34137	 34138					
34137	5" x 7"	High/Low	1100/600	6000 kelvin	12v/24v	1 Pc. / Card
34138	7"	High/Low	950/500	5700 kelvin	12v/24v	1 Pc. / Card

Also Available:

Technical Specs

Item	Size / Color	Beam	Lumens	Watts	Voltage	Unit / Box
 34131	 34132					
34131	4" x 6" / Chrome	Low	1000	20	12v/24v	1 Pc. / Color Box
34132	4" x 6" / Chrome	High	1200	24	12v/24v	1 Pc. / Color Box
 34133	 34134					
34133	4" x 6" / Black	Low	1000	20	12v/24v	1 Pc. / Color Box
34134	4" x 6" / Black	High	1200	24	12v/24v	1 Pc. / Color Box

NEW ITEMS

December 2020



110093



110092



Glove Box Door For 1964-66 Chevy Truck

- Excellent stamped 20 gauge steel reproduction with all of the original contour detail
- Features precision cut lock cylinder pocket, rectangular front recess for OE Chevrolet emblem, and three OE style cup holder recesses on inner panel
- Includes door spring and welded 1/4-20 hinge nuts
- Available in beautiful chrome plated finish or black EDP coated finish

110093 Chrome - 1 Pc. / Box **(New)**

110092 Black - 1 Pc. / Box



Glove Box Door Hinge For 1964-66 Chevy Truck

- Excellent quality steel stamping
- Exact design as original with mounting holes for easy installation
- Finish with black EDP protective coating

110094 1 Pcs. / Box



Quarter Window Assembly w/Clear Glass For 1967-68 Ford Mustang Coupe

- Heavy 16 gauge stamped steel window track with mounting hardware
- Crystal clear non-tinted tempered window glass
- Beautiful polished stainless steel window frame w/ weather-strip
- Fully assembled from factory for a quick and straight forward replacement

110645 L/H - 1 Pc. / Box

110644 R/H - 1 Pc. / Box

PRODUCT INDEX

ITEM#	PAGE#	ITEM#	PAGE#	ITEM#	PAGE#
23497	14	110217	12	110899	18
23498	14	110249	5	30610B	6
23499	14	110250	5	A1060-4	26
31050	19	110265	15	A1068	22
34131	20	110446	12	A6219	26
34131	27	110480	11	A6220	26
34132	20	110481	11	ACBR02	19
34132	27	110516	4	ANF1215	13
34133	20	110588	8	ANF1216	13
34133	27	110589	8	ANF1217	13
34134	20	110644	28	ANF1218	13
34134	27	110645	28	ANF1219	13
34135	27	110697	20	B20331	25
34136	27	110712	22	B20332	25
34137	27	110713	22	B20333	25
34138	27	110714	22	B20334	25
36446	17	110715	22	B21507	21
36447	17	110735	4	C1007	24
36448	17	110736	4	C1009	24
36452	13	110737	4	C5016	22
36454	6	110738	4	C555601	11
36455	6	110772	16	C687201	7
36456	6	110773	16	C7016	21
36457	6	110774	16	F646605	21
39065	12	110775	16	F646606	21
39909	11	110776	17	S2007LED	15
50088	10	110777	17	S2007LED-A	15
50089	10	110804	7	S2007LED-W	15
50148	15	110804	16		
50149	15	110805	7		
50187	15	110805	16		
52009	24	110806	11		
52010	24	110825	7		
72003	26	110826	7		
72046	9	110827	7		
72047	9	110837	14		
72053	26	110838	14		
95002	19	110840	21		
99060	17	110841	26		
99086	21	110842	6		
99193	11	110858	23		
99194	11	110860	9		
99195	11	110861	9		
99196	15	110862	9		
110092	28	110863	9		
110093	28	110864	9		
110094	28	110867	8		
110147	12	110868	5		
110148	12	110870	18		
110149	12	110871	18		
110168	12	110874	23		
110203	15	110875	23		
110204	15	110876	8		
110205	15	110877	5		
110205	15	110878	5		
110206	7	110884	8		
110207	10	110887	18		
110210	15	110888	18		
110210	15	110896	14		
110211	15	110897	20		
110211	15	110898	20		



NEW ITEMS



Round Exterior Mirror For 1966-72 Chevy Passenger Car

- Exceptional quality die cast metal and beautifully chrome plated with Chevy bowtie logo
- Available with special behind-the-mirror LED design, hidden when not in use
- Convex mirror for wide angle visibility for R/H side
- Includes mounting pad and screws
- Officially licensed GM restoration part

- C687201** Fits L/H or R/H - 1 Pc. / Color Box
- 110826** R/H w/Convex Mirror &LED Turn Signal - 1 Pc. / Color Box
- 110827** R/H w/Convex Mirror - 1 Pc. / Color Box
- 110825** L/H w/LED Turn Signal - 1 Pc. / Color Box



One-Piece Style LED Tail Light For 1955 Chevy Car

- 48 SMD super bright LED with high quality all red polycarbonate lens
- Custom style one-piece design with backup light deleted
- Direct plug & play installation with 1157 type connector
- Electronics completely sealed in epoxy to resist corrosion and moisture
- Solid state circuit board engineered for any 12VDC system

- 110206** 1 Pc. / Card

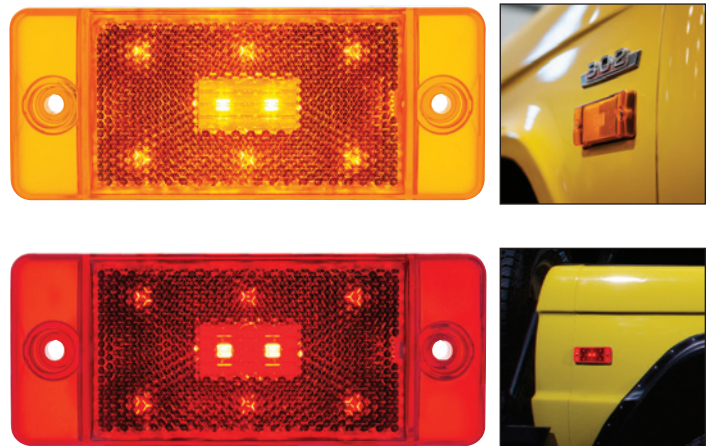

LED Side Marker For 1970-77 Ford Bronco

- 8 LED Dual function, parking light and turn signal
- Super bright amber LED with amber or red acrylic lens
- Epoxy coated, fully sealed electronics
- Fits left hand and right hand

- 110804** Front LED Side Marker - Amber - 1 Pc. / Card
- 110805** Rear LED Side Marker - Red - 1 Pc. / Card



289/302/351W Long Tube Headers For 1966-77 Bronco

- Fits all 1966-77 Broncos with a 289, 302, or 351W V8 engine
- Extra-thick 16 gauge 1 1/2" mandrel-bent tube
- 3/8" thick laser cut flanges resist warping
- Designed to provide ample clearance for tight areas
- Long tube design delivers maximum horsepower and torque

110588 Black - 1 Set / Box

110589 Silver Ceramic Coated - 1 Set / Box



Plain Style Tailgate Without Ford Letters For 1966-77 Ford Bronco

- High quality heavy 16 gauge steel aftermarket reproduction of the original Ford tailgate
- Precision cut latch handle pocket with 1/4"-20 welded nuts and recessed mounting holes on the inside panel
- Includes tailgate linkage posts, tailgate trunion pockets, and latch pockets with 5/16"-18 threaded holes
- Features license plate light pocket, wiring holes, and small 0.087" diameter mounting holes
- Finished with black EDP protective coating to keep your new steel fresh and rust-free

110884 1 Pc. / Box



Chrome Interior Dome Light Assembly For 1960-72 Chevy/GMC Truck & Suburban

- Chrome plastic housing with lens, 12V light bulb, 143" OE style wiring harness and plug connector

110876 1 Pc. / Box



Rear Inner Wheelhouse For 1967-72 Chevrolet Fleetside Truck

- Excellent 18 gauge steel reproduction of the OE style wheelhouse
- Features all original curvature and mounting pattern
- Finished with black EDP protective coating to keep your new steel fresh and rust-free
- Fits lefthand or righthand side, two required for each truck
- Fits 1967-72 Chevrolet/GMC Fleetside Truck, 67-72 Chevrolet Blazer and 70-72 GMC Jimmy

110867 1 Pc. / Bulk



Sitting Pig Ornament

- Detailed die-casting with beautiful chrome plating
- Easy installation on any vehicle with three mounting studs
- Approximately 5-1/2" x 3-1/2" x 4-1/2"
- Mounting pad and hardware included
- Perfect decorator item for home, office and man cave

72046 Chrome - 1 Pc. / Color Box

72047 Black - 1 Pc. / Color Box



Cab Mount Kit For 1960-66 Chevy Truck

- Quality molded rubber cab mounts
- Includes all mounting bolts, lock nuts, spacers and large washers
- 28 piece kit

110860 1 Set / Box

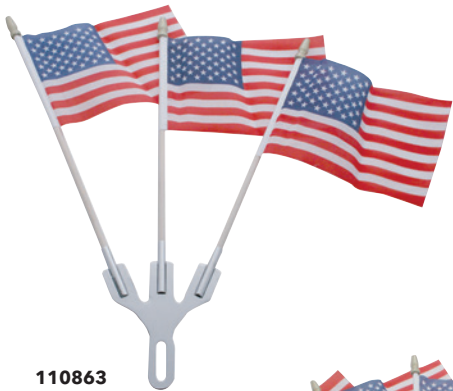

110863



110864

Stainless Steel Flag Holder with Flags

- Stainless flag holder with flags
- Show your patriotism

110863 3 Flags - 1 Set / Card

110864 5 Flags - 1 Set / Card



110861



110862

Stainless Steel Flag Holder

- Stainless flag holder only
- Fits United Pacific U.S.A. flag item No. C9003

110861 3 Post - 1 Pc. / Bulk

110862 5 Post - 1 Pc. / Bulk





NEW ITEMS



Round Exterior Mirror For 1966-72 Chevy Passenger Car

- Exceptional quality die cast metal and beautifully chrome plated with Chevy bowtie logo
- Available with special behind-the-mirror LED design, hidden when not in use
- Convex mirror for wide angle visibility for R/H side
- Includes mounting pad and screws
- Officially licensed GM restoration part

- C687201** Fits L/H or R/H - 1 Pc. / Color Box
- 110826** R/H w/Convex Mirror &LED Turn Signal - 1 Pc. / Color Box
- 110827** R/H w/Convex Mirror - 1 Pc. / Color Box
- 110825** L/H w/LED Turn Signal - 1 Pc. / Color Box



One-Piece Style LED Tail Light For 1955 Chevy Car

- 48 SMD super bright LED with high quality all red polycarbonate lens
- Custom style one-piece design with backup light deleted
- Direct plug & play installation with 1157 type connector
- Electronics completely sealed in epoxy to resist corrosion and moisture
- Solid state circuit board engineered for any 12VDC system

- 110206** 1 Pc. / Card

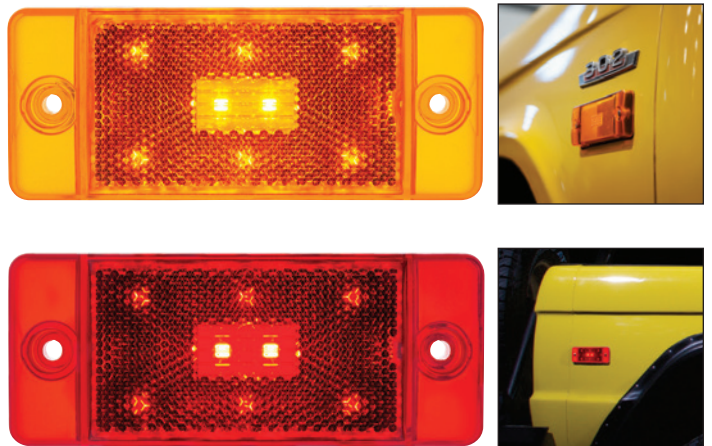

LED Side Marker For 1970-77 Ford Bronco

- 8 LED Dual function, parking light and turn signal
- Super bright amber LED with amber or red acrylic lens
- Epoxy coated, fully sealed electronics
- Fits left hand and right hand

- 110804** Front LED Side Marker - Amber - 1 Pc. / Card
- 110805** Rear LED Side Marker - Red - 1 Pc. / Card



289/302/351W Long Tube Headers For 1966-77 Bronco

- Fits all 1966-77 Broncos with a 289, 302, or 351W V8 engine
- Extra-thick 16 gauge 1 1/2" mandrel-bent tube
- 3/8" thick laser cut flanges resist warping
- Designed to provide ample clearance for tight areas
- Long tube design delivers maximum horsepower and torque

110588 Black - 1 Set / Box

110589 Silver Ceramic Coated - 1 Set / Box



Plain Style Tailgate Without Ford Letters For 1966-77 Ford Bronco

- High quality heavy 16 gauge steel aftermarket reproduction of the original Ford tailgate
- Precision cut latch handle pocket with 1/4"-20 welded nuts and recessed mounting holes on the inside panel
- Includes tailgate linkage posts, tailgate trunion pockets, and latch pockets with 5/16"-18 threaded holes
- Features license plate light pocket, wiring holes, and small 0.087" diameter mounting holes
- Finished with black EDP protective coating to keep your new steel fresh and rust-free

110884 1 Pc. / Box



Chrome Interior Dome Light Assembly For 1960-72 Chevy/GMC Truck & Suburban

- Chrome plastic housing with lens, 12V light bulb, 143" OE style wiring harness and plug connector

110876 1 Pc. / Box



Rear Inner Wheelhouse For 1967-72 Chevrolet Fleetside Truck

- Excellent 18 gauge steel reproduction of the OE style wheelhouse
- Features all original curvature and mounting pattern
- Finished with black EDP protective coating to keep your new steel fresh and rust-free
- Fits lefthand or righthand side, two required for each truck
- Fits 1967-72 Chevrolet/GMC Fleetside Truck, 67-72 Chevrolet Blazer and 70-72 GMC Jimmy

110867 1 Pc. / Bulk



Sitting Pig Ornament

- Detailed die-casting with beautiful chrome plating
- Easy installation on any vehicle with three mounting studs
- Approximately 5-1/2" x 3-1/2" x 4-1/2"
- Mounting pad and hardware included
- Perfect decorator item for home, office and man cave

72046 Chrome - 1 Pc. / Color Box

72047 Black - 1 Pc. / Color Box



Cab Mount Kit For 1960-66 Chevy Truck

- Quality molded rubber cab mounts
- Includes all mounting bolts, lock nuts, spacers and large washers
- 28 piece kit

110860 1 Set / Box

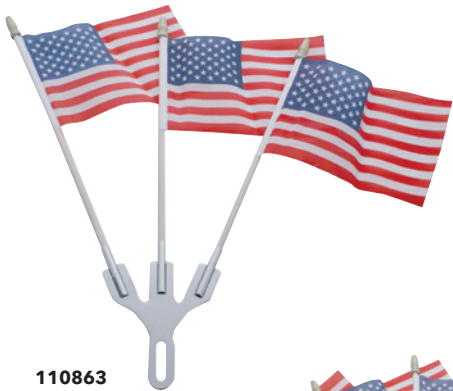

110863



110864

Stainless Steel Flag Holder with Flags

- Stainless flag holder with flags
- Show your patriotism

110863 3 Flags - 1 Set / Card

110864 5 Flags - 1 Set / Card



110861



110862

Stainless Steel Flag Holder

- Stainless flag holder only
- Fits United Pacific U.S.A. flag item No. C9003

110861 3 Post - 1 Pc. / Bulk

110862 5 Post - 1 Pc. / Bulk





NEW ITEMS



One-Piece Style Sequential LED Tail Light For 1955 Chevy Car

- 48 SMD super bright LED with high quality all red polycarbonate lens
- Custom style one-piece design with backup light deleted
- Features sequential function with selector switch to control sequential function off, direction left, or direction right
- Also features brake attention option with sequence-once function
- Direct plug & play installation with 1157 type connector
- Electronics completely sealed in epoxy to resist corrosion and moisture
- Solid state circuit board engineered for any 12VDC system
- Recommend to upgrade under dash flasher to item no. 90652 or 90649 LED flasher
- Recommend license plate with LED back-up light, item no. 50187



(((BRAKE ATTENTION)))

(((SEQUENTIAL F.L.A.S.H)))



110207

1 Pc. / Card



Chrome 1929-39 California License Plate Frame

- For Vintage 1929-39 California license plates with sharper corners
- High quality stamped steel with chrome plating

50088

1 Pc. / Card



Chrome 1940-55 California License Plate Frame

- For Vintage 1940-55 California license plates with rounded corners
- High quality stamped steel with chrome plating

50089

1 Pc. / Card



Rear Fuel Tank Strap For 1966-76 Ford Bronco

- Made of high-quality galvanized stamped steel
- Black EDP coated to keep your new steel fresh and rust-free
- J-bolt included for proper installation

110806 1 Pc. / Bulk

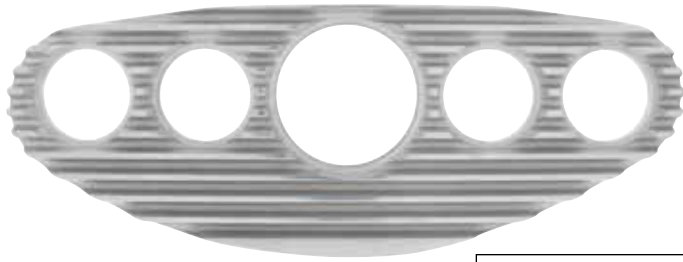

110480

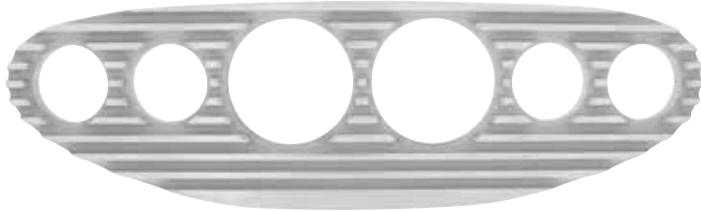

110481



Finned Style Aluminum Dash Panel

- Cast with aluminum and CNC finished faces
- Finned style design
- Four outer holes with 2-1/16" inside diameter
- Two pre-tapped #6-32 holes for straight forward installation

110480 Five Hole - 1 Pc. / Box

110481 Six Hole - 1 Pc. / Box



Chrome "Bel-Air" Script Emblem For 1955-56 Chevy Bel-Air

- Fits rear quarter panel, duplicate of original
- Beautiful chrome plated with triple chrome plating process
- Includes mounting clips
- GM restoration licensed product

C555601 1 Pc. / Bulk



COMPETITION
SERIES

2 White LED Chrome License Plate Light/Utility Light - Competition Series

- Super bright white LED utility/license light, 12 volt
- Chrome housing, water resistant
- Includes mounting pad & screws

39909 1 Pc. / Card



99193



99194



99195

United Pacific Work Light Display

- Polished stainless steel display base
- Completely assembled and wired
- 12 Volt power supply included

99193 36671/36672/36507/36965 - 1 Pc. / Box

99194 36461/36462/36506/36965 - 1 Pc. / Box

99195 36463/36464/36506/36965 - 1 Pc. / Box





NEW ITEMS



110772



110773



Anodized Billet Aluminum Side Marker Bezel w/ Raised Side Protection For 1970-77 Ford Bronco

- Beautifully CNC milled from billet aluminum
- Durable clear anodized finish to increase corrosion resistance while keeping the machined finished look
- Includes two stainless steel screws and mounting gasket
- Also fits 1970-74 Econoline, and rear only on 1970-72 F100, F150, & F250
- Sold each



110772 Clear Anodized Finish - 1 Pc. / Color Box

110773 Black Anodized Finish - 1 Pc. / Color Box



110774



110775

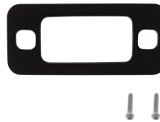

Anodized Billet Aluminum Side Marker Light Bezel For 1970-77 Ford Bronco

- Beautifully CNC milled from billet aluminum
- Durable clear anodized finish to increase corrosion resistance while keeping the machined finished look
- Includes two stainless steel screws and mounting gasket
- Also fits 1970-74 Econoline, and rear only on 1970-72 F100, F150, & F250
- Sold each

110774 Clear Anodized Finish - 1 Pc. / Color Box

110775 Black Anodized Finish - 1 Pc. / Color Box

HOT ITEM

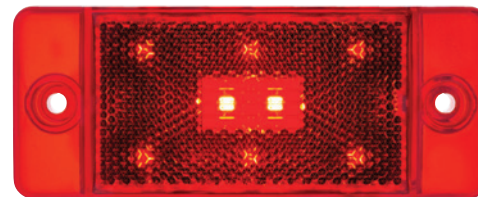
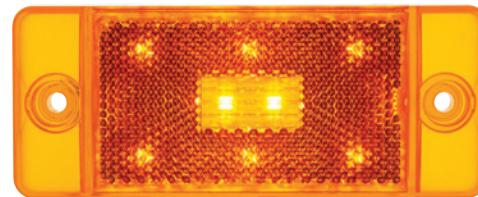

LED Side Marker For 1970-77 Ford Bronco

- 8 LED Dual function, parking light and turn signal
- Super bright amber LED with amber or red acrylic lens
- Epoxy coated, fully sealed electronics
- Fits left hand and right hand

110804 Front LED Side Marker - Amber - 1 Pc. / Card

110805 Rear LED Side Marker - Red - 1 Pc. / Card



110776



110777



Anodized Billet Aluminum Steering Column Cover For 1966-77 Ford Bronco

- Beautifully CNC milled from billet aluminum
- Upgrades the original plastic steering column cover to heavy duty billet aluminum
- Durable clear anodized finish to increase corrosion resistance while keeping the machined finished look
- Two-piece design for easy installation

110776 Clear Anodized Finish - 1 Pc. / Card

110777 Black Anodized Finish - 1 Pc. / Card

New Upgraded Slim Low Profile Design



36446

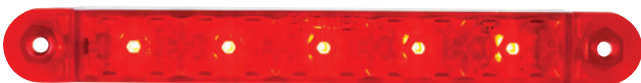

36447

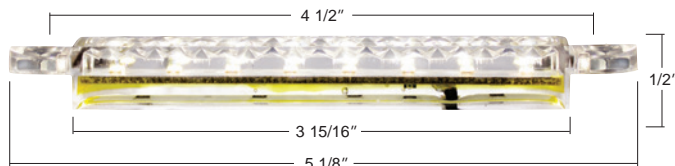

36448

5" SMD LED Light Strip With Hard Wire

- 5 Super bright SMD LED strip with fully sealed electronics
- 12VDC, available in dual function red or amber, or single function white
- Captive #6-32 nuts for rear flush mounted installation
- For clean and proper mounting, a 3-15/16 X 5/8" rectangular pocket is required
- Please see "Attachment-Line Art" for more dimensional details

36446 Amber LED - 1 Pc. / Card

36447 Red LED - 1 Pc. / Card

36448 White LED - 1 Pc. / Card



Tire Checker Bat

- United Pacific 17" aluminum tire checker

99060 1 Pc. / Bulk





NEW ITEMS



110871



110870



Anodized Aluminum Headlight Bezel For 1969-72

- Quality stamped 24 gauge aluminum with rolled edges
- Beautiful clear anodized finish

110870 L/H - 1 Pc. / Box

110871 R/H - 1 Pc. / Box



Stainless Steel Hood Spring For 1967-72 Chevrolet & GMC Truck (Pair)

- Specially engineered to have the same yield and tensile strength as original
- Corrosion resistant stainless steel, with a bright electropolished satin finish
- Sold in pairs

110899 1 Pair / Bulk



Glove Box Lock Cylinder w/Keys For 1947-53 Chevy/GMC Truck

- Quality reproduction of original style lock cylinder
- Includes 2 keys with GM marking
- Official GM licensed restoration product

110888 1 Pc. / Bulk



Door Lock Cylinder W/Keys For 1947-51 Chevy/GMC Truck

- Outside door lock cylinder with 2 keys
- Official GM licensed restoration product

110887 1 Pc. / Bulk

Stellar Pluto+ Duo Bundle Headset

- A Trucker's "best friend" headset offering battery life for longest talk time, best comfort, unique style and quality sound
- "Pluto" mode is single earpiece and 30 hours of talk time / 500 hours of stand-by time
- "Duo" mode adds a stereo earpiece for 60 hours of talk time / 900 hours stand-by time
- "Duo" earpiece is also a USB power bank to charge other devices on the go
- Noise Armor® technology offers the best noise cancellation for truckers. No more "I can't hear"
- Bluetooth 5.0 compatible, and has longer range and more connectivity for your devices
- Durable carrying case, dual USB car charger, and USB cable included



95002 1 Set / Box

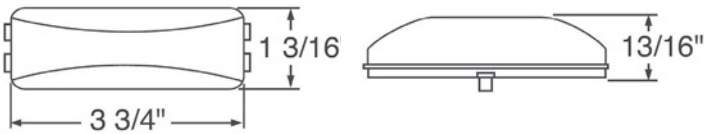

Incandescent Rectangular Fender Mount Clearance/Marker Light - Amber & Red Lens

- Functions as both front and rear clearance light for trailers over 80 inches wide
- High quality injection molded dual color, amber and red plastic lens
- Polycarbonate lens sonically sealed to housing to prevent moisture intrusion
- Grease filled terminals to prevent corrosion
- Recommend mounting/quick-connect base: item # 30919 (chrome) or item # 33006 (black)

31050 1 Pc. / Bulk

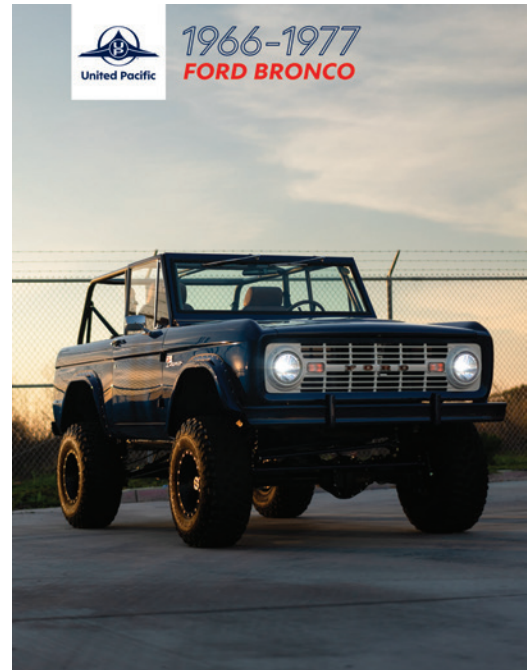

1966-77 Ford Bronco Catalog - 2nd Edition

ACBR02 1 Pc. / Bulk



NEW ITEMS



34131



34132

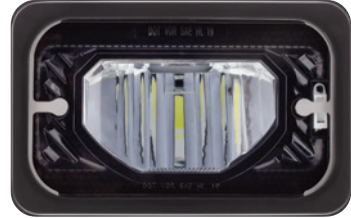

34133



34134

4" X 6" Heated LED Headlight

- Features a heating system that automatically de-ices the headlight according to ambient temperature
- Durable glass lens with heavy duty aluminum housing
- Plug & play with standard H4 style connector plug for ease of installation
- Available in high beam and low beam with choice of chrome or black inner liner
- Low beam: 1000 lumens, high beam: 1200 lumens, 12-24VDC, 20 watts

34131	Chrome	Low Beam - 1 Pc. / Color Box
34132	Chrome	High Beam - 1 Pc. / Color Box
34133	Black	Low Beam - 1 Pc. / Color Box
34134	Black	High Beam - 1 Pc. / Color Box

Heavy Duty Aluminum Housing High Power LED

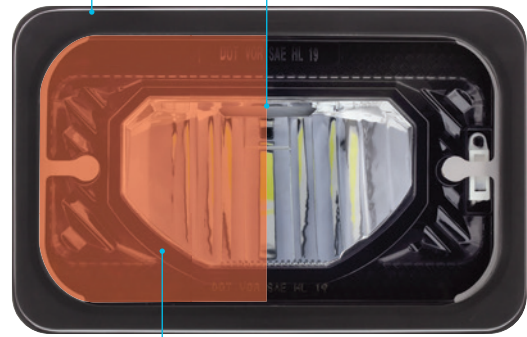

Electrical Heating System
Automatic De-ices the Headlight According to Ambient Temperature



100%LED

DOT

Technical Specification	
Low Beam Application	High Beam Application
1000 Lumens	1200 Lumens
12VDC - 24VDC Input	12VDC - 24VDC Input
20 Watts	24 Watts



Dash Bezel For 1969-72 Chevy/GMC Truck With 7 Gauges - Black & Chrome

- High quality plastic injection molded reproduction of the original
- Beautiful chrome plated outer trim with black painted inner face
- Feature original mounting pattern with mounting posts for easy installation

110697	1 Pc. / Box
---------------	-------------



110897

110898



UP# 110899 Available Separately

Chrome Hood Hinge For 1967-72 Chevrolet & GMC Truck

- Heavy duty steel reproduction of the original hood hinge style and design
- Beautifully chrome plated with triple chrome plating process
- Stainless steel springs available separately, UP#110899

110897	L/H - 1 Pc. / Box
110898	R/H - 1 Pc. / Box



Bed Front Panel For 1932-37 Ford Truck

- Die stamped with high quality 16 gauge sheet metal
- Features original style stiffening ribs and square-shape top edge
- Finished with black EDP protective coating to keep your new steel fresh and rust-free

B21507 1 Pc. / Box



Black Arm Rest For 1968-77 Ford Bronco (Pair)

- Perfect for replacing that wore out arm rest on an early Bronco
- High quality synthetic leather in black finish
- Mounting pocket with original mounting pattern for easy replacement

110840 1 Pair / Box



Primer Finished Outside Sunvisor For 1955-59 Chevy Passenger Car

- Excellent reproduction with original detail
- Features precision punched mounting holes and center reinforcement brace
- Ready for paint with primer finished coating

C7016 1 Pc. / Bulk



Improved Mounting Pad

Remote Exterior Mirror Kit For 1964.5 -66 Ford Mustang

- Beautiful die-cast and chrome plated exactly as original
- Features remote linkage with handle and mounting plate
- Includes mounting pad and screws

F646605 L/H - 1 Pc. / Box

F646606 R/H - 1 Pc. / Box



United Pacific Cap - Camo U.P. Cap

- 100% cotton twill cap

99086 1 Pc. / Bulk





NEW ITEMS

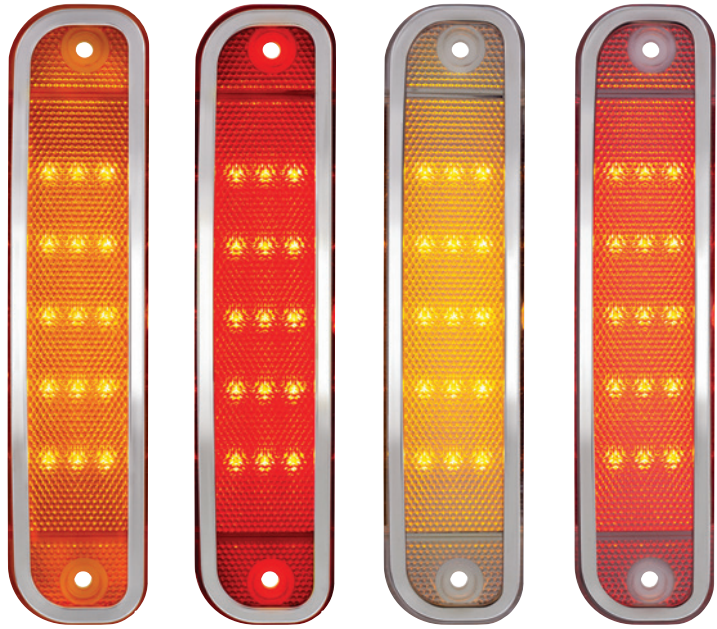

110712

110713

110714

110715

15 LED Side Marker Light With Stainless Steel Trim For 1973-80 Chevrolet Truck

- Super bright LED with high quality injection molded acrylic lens
- Dual function, parking light and turn signal
- Polished stainless steel deluxe style trim
- Epoxy coated, fully sealed electronics
- Also fits 1973-91 Chevy & GMC dually rear



- 110712** Amber LED/Amber Lens - 1 Pc. / Card
- 110713** Red LED/Red Lens - 1 Pc. / Card
- 110714** Amber LED/Clear Lens - 1 Pc. / Card
- 110715** Red LED/Clear Lens - 1 Pc. / Card



3 Candle Power 6V Parking Light Bulb For 1928-48 Ford Car & Truck

- #63 style, 6 volt, single contact with BA15s base
- Typically used on early Fords for cowl lights, parking lights, dash lights

A1068 1 Pc. / Bulk



Black Powder Coated Magnetic Pipe Holder With Felt Liner

- No-Scratch felt lining
- Strong magnetic securely sticks to any metal dashboard
- Keep pipe within easy reach

C5016 1 Pc. / Color Box



NEW ITEMS



Titan Cap™

Locking Gas Cap for 1947-71 Chevy and Ford

- Top quality rugged all metal military style fuel cap design
- Fits 1947-71 Chevy & GMC trucks, 1949-70 Ford cars, 1957-70 Ford trucks & Bronco
- Great for off-road enthusiasts who value extreme-armor designs and fitments
- Available in chrome plated or matte black painted finish
- Vented gas cap for vented fuel systems only

110874 Chrome - 1 Pc. / Card

110875 Black - 1 Pc. / Card

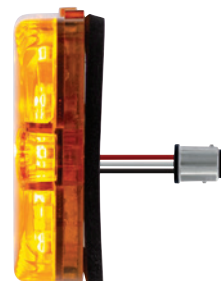
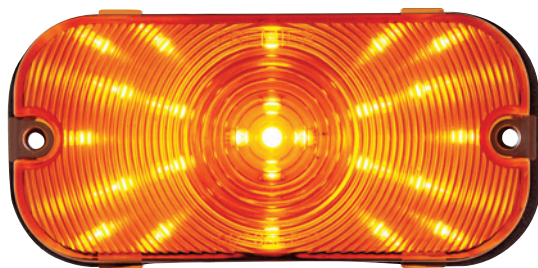

25 LED Parking/Signal Light For 1966-68 Ford Bronco

- LED Dual function, parking light and turn signal
- Super bright amber LED with amber acrylic lens
- Epoxy coated, fully sealed electronics, 1157 plug
- Fits left hand and right hand
- Gasket included



110858 1 Pc. / Card



Stainless Steel Fender Skirt Scuff Pads For 1956 Chevy Passenger Car (Pair)

- Made of top grade, rust free, T304 stainless steel
- Highly polished to a mirror like shine

C1007 1 Pair / Bulk



Stainless Steel Fender Skirt Scuff Pads For 1959 Chevy Passenger Car (Pair)

- Made of top grade, rust free, T304 stainless steel
- Highly polished to a mirror like shine

C1009 1 Pair / Bulk



Chrome Skull Shift Linkage For Harley

- Unique 3D skull design with triple chrome plating for a lasting show-bike shine
- High quality adjustable rod end ball joints to ensure smooth operation
- Includes a straight transmission lever cover and decorative acorn nuts and bolts. (Note: cover does not fit 2017+ Milwaukee-Eight with curved trans lever)
- Complete the look with Skull Swing Arm Insert Set, UP# 52010
- Fits 1986+Harley Softtail (except 18+ FXBB and FXLR), Touring and Trike models. (Does not fit 97- 99 FLSTS or models equipped with Softail Extended Reach Forward Controls.)

52009 1 Pc. / Card



Chrome Skull Swing Arm Accent Set For Harley

- Fits 2008-17 Harley-Davidson Softtail models (except FXCW, FXCWC, FXSB, and FXSBSE)
- Unique four-piece skull accent set to dress up the recessed area in the rear swing arm frame
- Easy to install with pressure sensitive adhesive mounting
- Beautifully chrome plated plastic injection molded
- Add a little attitude to your ride

52010 1 Set / Card





NEW ITEMS



B20331



B20332



B20330 - Front Fender Brace

Steel Front Fender For 1932 Ford Car & Truck

- Quality stamped steel, exactly as original Henry!
- Fender edge bead with steel inner wire as original
- Finished with black EDP protective coating to keep your new steel fresh and rust-free
- Fits all 1932 Ford vehicles including 1932 Truck. However, fender does NOT have spare tire well.
- Available in left hand or right hand applications

B20331 L/H - 1 Pc. / Box

B20332 R/H - 1 Pc. / Box



B20333



B20334

Rear Fender for 1932 Ford 5W Coupe & Roadster

- Quality stamped steel, exactly as original Henry!
- Made of excellent 20 gauge sheetmetal
- Fender edge bead with steel inner wire as original
- Precision punched quarter panel mounting holes
- Includes mounting holes for frame horn cover
- Coated with black EDP
- Sold individually, please specify left or right hand side

B20333 L/H - 1 Pc. / Box

B20334 R/H - 1 Pc. / Box





Stainless Steel Bumper End Bolts And Nuts For 1928-31 Ford Model A (Pair)

- Beautiful quality stainless steel
- Exact shape and size as the original
- 5-1/8" partial threaded with 1" long 7/16"-20 threads
- Feature original style anti-rotation key design under the head of the bolt

A6219 1 Pair / Bulk



Stainless Steel Bumper Bar Spacer For 1928-31 Ford Model A (Pair)

- Highly polished stainless steel
- A spacer between 2 bumper bars

A6220 1 Pair / Bulk



Cab Mount Kit For 1949-54 Chevy And GMC Truck

- Complete cab mounting kit with fasteners
- Features heavy duty reinforced rubber square pad and mounting fasteners for front cab installation
- Quality molded rubber bushing for the rear cab mount shackles
- 18 piece kit
- Includes installation diagram

110841 1 Set / Bulk



Highly Detailed Basset Hound Ornament

- Detailed die-casting with beautiful chrome plating or matte black powder coated finish
- Easy installation on any vehicle with four mounting studs
- Approximately 7-5/8" x 4-1/8" x 7-1/4"
- Mounting hardware included
- Ideal for decorating small and personal space, home, office and garage

72003 Chrome - 1 Pc. / Color Box

72053 Black - 1 Pc. / Color Box



19" Double Contact Pigtail

- 18 AWG thermoplastic jacketed wires
- Tinned copper wires for better corrosion resistance
- Nylon insulation plate

A1060-4 1 Pc. / Bulk

Heated LED Headlights with Polycarbonate Lens & Housing

Available Mid-November





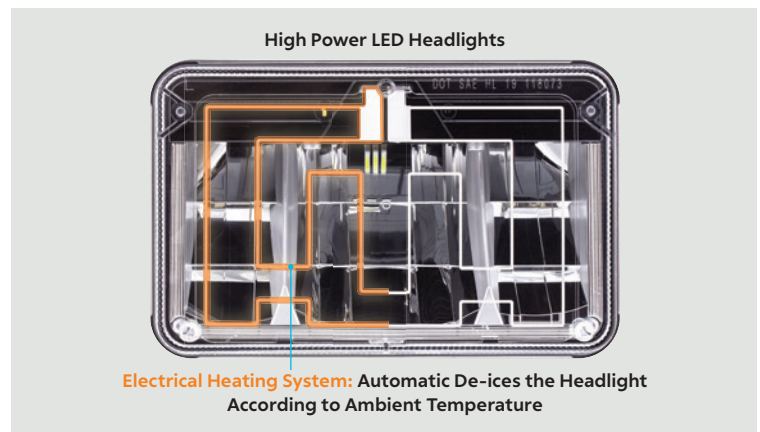



- Features a heating system that automatically de-ices and defrosts the headlight lens when outside temperature reaches 50 degrees Fahrenheit (10 Celsius) or below
- Integrated monitoring system to turn off heating when snow & ice has cleared from lens
- Durable corrosion resistant polycarbonate lens, housing & electronics resist shock and vibration
- Plug & play with standard H4 style connector plug for ease of installation

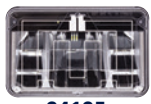

100% LED

DOT

Technical Specs

Item	Size	Beam	Lumens	Color Temp.	Voltage	Unit / Box	
 34135	 34136	4" x 6"	Low	750	6500 kelvin	12v/24v	1 Pc. / Card
 34136	 34138	4" x 6"	High	1000	6500 kelvin	12v/24v	1 Pc. / Card
 34137	 34138	5" x 7"	High/Low	1100/600	6000 kelvin	12v/24v	1 Pc. / Card
 34138		7"	High/Low	950/500	5700 kelvin	12v/24v	1 Pc. / Card

Also Available:

Technical Specs

Item	Size / Color	Beam	Lumens	Watts	Voltage	Unit / Box	
 34131	 34132	4" x 6" / Chrome	Low	1000	20	12v/24v	1 Pc. / Color Box
 34132	 34133	4" x 6" / Chrome	High	1200	24	12v/24v	1 Pc. / Color Box
 34133	 34134	4" x 6" / Black	Low	1000	20	12v/24v	1 Pc. / Color Box
 34134		4" x 6" / Black	High	1200	24	12v/24v	1 Pc. / Color Box





NEW ITEMS



110093



110092



Glove Box Door For 1964-66 Chevy Truck

- Excellent stamped 20 gauge steel reproduction with all of the original contour detail
- Features precision cut lock cylinder pocket, rectangular front recess for OE Chevrolet emblem, and three OE style cup holder recesses on inner panel
- Includes door spring and welded 1/4-20 hinge nuts
- Available in beautiful chrome plated finish or black EDP coated finish

110093 Chrome - 1 Pc. / Box (New)

110092 Black - 1 Pc. / Box



Glove Box Door Hinge For 1964-66 Chevy Truck

- Excellent quality steel stamping
- Exact design as original with mounting holes for easy installation
- Finish with black EDP protective coating

110094 1 Pcs. / Box



Quarter Window Assembly w/Clear Glass For 1967-68 Ford Mustang Coupe

- Heavy 16 gauge stamped steel window track with mounting hardware
- Crystal clear non-tinted tempered window glass
- Beautiful polished stainless steel window frame with weather-strip
- Fully assembled from factory for a quick and straight forward replacement

110645 L/H - 1 Pc. / Box

110644 R/H - 1 Pc. / Box





NEW ITEMS



DOT & SAE

38 LED Sequential Tail Light with Housing for 1953-56 Ford Truck

- Super bright SMD LED with high quality all red polycarbonate lens
- Features sequential function with selector switch to control sequential function off, direction left, or direction right
- Features sequence-once brake attention function
- Fully assembled with beautiful polished stainless steel or glossy black die stamped metal housing with mounting studs
- Recommended under dash flasher United Pacific 90652 (2-terminal) or 90651 (3-terminal)
- Sold individually, please specify left-hand or right-hand side



(((SEQUENTIAL)))
F · L · A · S · H

(((BRAKE)))
ATTENTION

110761	Stainless Steel	L/H - 1 Pc. / Card
110762	Stainless Steel	R/H - 1 Pc. / Card
110763	Black	L/H - 1 Pc. / Card
110764	Black	R/H - 1 Pc. / Card



DOT & SAE

38 LED Tail Light with Housing for 1953-56 Ford Truck

- Super bright SMD LED with high quality all red polycarbonate lens
- Left hand side feature additional white LED with clear lens for license plate light
- Fully assembled with stainless steel or glossy black housing with mounting studs
- Electronics completely sealed in epoxy to resist corrosion and moisture
- Solid state circuit board engineered for any 12V DC system
- Easy electrical connection with stripped wire leads
- Recommended under dash flasher United Pacific 90652(2-terminal) or 90651 (3-terminal)
- Sold individually, please specify left-hand or right-hand side

110935	Stainless Steel	L/H - 1 Pc. / Card (New)
110936	Stainless Steel	R/H - 1 Pc. / Card (New)
110759	Black	L/H - 1 Pc. / Card
110760	Black	R/H - 1 Pc. / Card



Cobra Style Interior Rearview Mirror

- Highly polished stainless steel 2-1/2" X 6" mirror head, with chrome plated mirror arm
- Perfect replica interior mirror for early Cobra's and hot rods

M1003	1 Pcs. / Color Box
--------------	--------------------





NEW ITEMS



110914



110915

Rear Fender For 1967 Chevy/GMC Stepside Truck

- Excellent steel reproduction with all of the original contour and detail
- Finished with black EDP protective coating to keep your new steel fresh and rust-free
- Precision punched mounting holes with reinforcement strip along the rolled edge
- Smooth style without side marker cutout
- Sold individually, please specify left-hand or right-hand side

110914 L/H - 1 Pc. / Box

110915 R/H - 1 Pc. / Box



110912



110913

Rear Fender For 1968-72 Chevy/GMC Stepside Truck

- Excellent steel reproduction with all of the original contour and detail
- Finished with black EDP protective coating to keep your new steel fresh and rust-free
- Precision punched mounting holes with reinforcement strip along the rolled edge
- Feature original style side marker mounting pocket
- Sold individually, please specify left-hand or right-hand side

110912 L/H - 1 Pc. / Box

110913 R/H - 1 Pc. / Box



Stainless Steel Windshield Frame Hinge For 1966-77 Ford Bronco

- High quality 304 grade 16 gauge stainless steel
- Feature machine punched holes for plug welding to windshield and cowl top panel
- Notch and large hole for wiper motor wiring pass-through

110595 1 Pc. / Bulk



LED Chrome Vintage Style Flashlight

- Features bright 50 lumens white LED, glass lens, morse code button, and hanging loop
- Cool vintage look, all-metal construction, satin chrome finish
- Use with roller-action classic car flashlight holder, item # C5012G (sold separately)
- Requires 2 "D" cells batteries. (not included)

110917 1 Pc. / Color Box



CML6872A

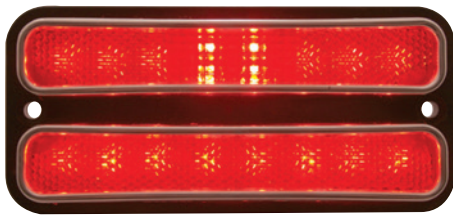

CML6872R

18 LED Side Marker Light W/Stainless Steel Trim For 1968-72 Chevy & GMC Truck

- Super bright LED with high quality injection molded polycarbonate lens
- Original look with deluxe stainless steel trim
- Epoxy coated, fully sealed electronics designed for 12V DC systems
- Easy electrical connection with 194 plug, no modification to vehicle
- 12 volt, 2-wire hookup with .180 bullet plugs

CML6872A Amber - 1 Pc. / Card

CML6872R Red - 1 Pc. / Card



Secure Roller-Action Grip



Vintage Flashlight Holder With Roller-Action Grip, Grey

- Tightly holds flashlight within easy reach
- Secure roller-action grip
- Fits steering columns up to 1-7/8" diameter

C5012G 1 Pc. / Color Box





NEW ITEMS

NEW



33012



33010

NEW



33011



33009

NEW



33014



33013

10 LED Dual Function 3rd Brake Light With Swivel Pedestal Base

- Polycarbonate lens sonically sealed to housing to prevent moisture intrusion
- Energy efficient solid-state circuit board engineered for 12V DC systems
- Dual function red LEDs, perfect for use as a driving and 3rd brake light
- Durable injection molded plastic housing with 180-degree swivel mounting base
- Designed with adjustable base mount for inside rear window installation
- Available in red or clear lens



Split Dual Function with Black Pedestal Base

33012 Split Function Red LED/Red Lens - 1 Pc. / Card **NEW**

Regular Dual Function with Black Pedestal Base:

33011 Dual Function Red LED/Red Lens - 1 Pc. / Card **NEW**

33014 Dual Function Red LED/Clear Lens - 1 Pc. / Card **NEW**

Split Dual Function with Chrome Pedestal Base

33010 Split Function Red LED/Red Lens - 1 Pc. / Card

Regular Dual Function with Chrome Pedestal Base:

33009 Dual Function Red LED/Red Lens - 1 Pc. / Card

33013 Dual Function Red LED/Clear Lens - 1 Pc. / Card





Tail Light For 1940 Chevy Passenger Car

- Gloss black powder coated housing with 304 stainless steel rim
- High quality glass lens
- Lens gasket, socket included
- 12V bulb and mounting hardware also included

C4052 1 Pc. / Box



17 LED Tail Light For 1940 Chevy Passenger Car

- Super bright red LED with high quality injection molded polycarbonate lens
- Energy efficient solid-state circuit board engineered for 12V DC systems
- Epoxy coated, fully sealed electronics
- Includes 304 stainless steel rim, black painted steel housing, socket, bulb, and mounting hardware
- Recommended to upgrade under dash flasher to item # 90652 or 90649 LED flasher

CTL4010LED-AS 1 Pc. / Box

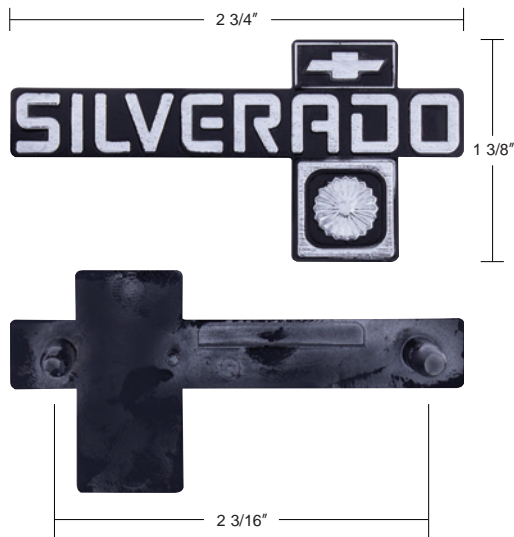

Silverado Dash Emblem For 1981-87 Chevy Truck

- Quality plastic injection molded with chrome lettering
- Original style design with mounting studs in OE spec spacing
- Speed nuts included for easy installation
- Official GM licensed restoration product

110916 1 Pc. / Bulk



Rear Bumper Bracket Kit For 1973-80 Chevy/GMC Fleetside Truck

- Heavy gauge steel reproduction with original style strengthening contour and feature
- Black powder coated to protect against corrosion
- Precision punched mounting holes
- Mounting hardware included

110928 1 Set / Box



NEW ITEMS



Parking Light For 1988-89 Chevrolet & GMC Truck

- Quality original style reproduction
- Injection molded rear housing
- Replacement for models with 4 sealed beam headlight system
- Also fits 1990-93 Chevy and GMC truck, additional hardware required
- Sold individually, please specify left-hand or right-hand side

110952 Driver - 1 Pc. / Box

110953 Passenger - 1 Pc. / Box



Rear Bumper Bracket Kit For 1967-72 Chevy/GMC Fleetside Truck

- Heavy duty 9 gauge steel reproduction
- Precision punched mounting holes
- Black EDP coating for durability
- Mounting hardware included

110926 1 Kit / Box





NEW ITEMS



Outer Rocker Panel For 1967-72 Chevy & GMC Truck

- Excellent reproduction of the original rocker panel with all contour detail
- Smooth top surface finish with quality steel
- Black EDP coated to keep your new steel fresh and rust-free
- Sold individually, please choose left-hand or right-hand side



110919 Driver - 1 Pc. / Bulk

110920 Passenger - 1 Pc. / Bulk



110897

110898



UP# 110899
Available Separately

Chrome Hood Hinge For 1967-72 Chevrolet & GMC Truck

- Heavy duty steel reproduction of the original hood hinge style and design
- Beautifully chrome plated with triple chrome plating process
- Stainless steel springs available separately, UP#110899

110897 L/H - 1 Pc. / Box

110898 R/H - 1 Pc. / Box



Bed Front Panel For 1967-72 Chevrolet & GMC Fleetside Truck With Steel Bed Floor

- Quality die stamped steel reproduction with 16 gauge steel
- Plain smooth style panel design
- OE style rolled over top flange with 1/4"-20 welded square nuts
- Precision punched bed side panel mounting holes
- Bottom flange made to match OE specification for use with steel bed floor

110896 1 Pc. / Box

32 PCS. CONVENIENCE PACK



Chrome Spike Hubcap Nut Cover For 1999-2018 Chevy & GMC 2500 & 3500 - Push-on (Color Box of 32)

- Quality molded plastic with beautiful long lasting chrome plating
- Sized to fit the twist-on simulated lug nut on OE steel wheel hubcap
- Fits GM lug nut #9597158, M27-2.0, Hex 22mm
- Fits various 1999-2018 Chevy/GMC trucks
- Convenience pack, includes 32 nut covers to dress up your entire truck

10351CB 32 Pcs. / Color Box

32 PCS. CONVENIENCE PACK



Chrome Cylinder Hubcap Nut Cover For 1999-2018 Chevy & GMC 2500 & 3500 - Push-on (Color Box of 32)

- Quality molded plastic with beautiful long lasting chrome plating
- Sized to fit the twist-on simulated lug nut on OE steel wheel hubcap
- Fits GM lug nut #9597158, M27-2.0, Hex 22mm
- Fits various 1999-2018 Chevy/GMC trucks
- Convenience pack, includes 32 nut covers to dress up your entire truck

10749CB 32 Pcs. / Color Box



United Pacific Cap - USA Flag United Pacific Cap

- 100% cotton twill cap
- Available in USA flag United Pacific Cap

99084 1 Pc. / Bulk



Classic LED Lighting Product Catalog 6th Edition

ACLED6 1 Pc. / Bulk



2020 Classic New Item Flyer Collection

ANF1220 1 Pc. / Bulk



NEW ITEMS



Super bright white LED cargo bed floor illumination



Integrated LED 3rd Brake Light



LED Cargo Light Assembly For 1969-72 Chevy & GMC Truck

- Super bright LED cargo light assembly with integrated LED 3rd brake light
- High quality heavy chrome plated die-cast housing
- Includes large rubber mounting pad, socket, lens gasket, lens screws and housing to cab mounting spacers

110147 1 Pc. / Color Box



Incandescent Cargo Light Assembly For 1969-72 Chevy & GMC Truck

- Complete original style incandescent cargo light assembly with 1004 bulb
- High quality heavy chrome plated die-cast housing
- Includes large rubber mounting pad, socket, lens gasket, lens screws and housing to cab mounting spacers

110446 1 Pc. / Color Box



110149



110217

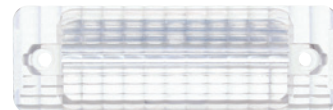

110168



39065



110148

110149 Mounting Pad - 1 Pc. / Bulk

110217 Lens Gasket - 1 Pc. / Bulk

110168 Lens - 1 Pc. / Card

39065 1004 Type Bulb - 1 Pc. / Bulk

110148 1004 Chrome Housing with Gasket - 1 Pc. / Color Box



LED Sequential Turn Signal

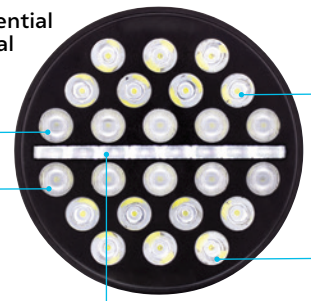

High Power LED Low Beam

High Power LED High Beam

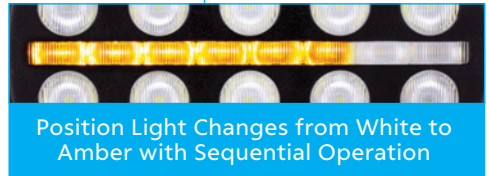

24 High Power LED 7" Light With Dual Color Position Light

- 24 LED high power 7" light with 8 dual color LED position light
- LED white/amber position light bar changes from white to amber when sequential light is activated
- Sequential amber position light can be connected for lefthand or righthand operation
- High beam: 5000 Lumens; Low beam: 2000 lumens; Position light-white: 200 lumens; Position light-amber: 125 lumens
- Easy connection, plugs into existing wiring harness, position light requires additional wiring. Installation in some OE light housings may require modification
- For off-road use only



Technical Specification

Low Beam Application

2000 Lumens
6000-6500K
12VDC - 24VDC input

High Beam Application

5000 Lumens
6000-6500K
12VDC - 24VDC input

36452 1 Pc. / Color Box



Antique New Item Flyer Collection

ANF1219 2019 New ITem Flyer Collection - 1 Pc. / Bulk

ANF1218 2018 New ITem Flyer Collection - 1 Pc. / Bulk

ANF1217 2017 New ITem Flyer Collection - 1 Pc. / Bulk

ANF1216 2016 New ITem Flyer Collection - 1 Pc. / Bulk

ANF1215 2015 New ITem Flyer Collection - 1 Pc. / Bulk

Check out an excellent selection of semi truck chrome trim we offer on our website.