



**Better Value • Better Options • Better Lighting**

BETTER VALUE BETTER LIGHTING BETTER OPTIONS BETTER LIGHTING BETT  
OPTRONICS BETTER LIGHTING BETTER VALUE BETTER LIGHTING BETT  
BETTER LIGHTING BETTER VALUE BETTER OPTIONS BETTER LIGHTI  
OPTRONICS BETTER LIGHTING BETTER VALUE BETTER OPTIONS BETT  
BETTER OPTIONS BETTER LIGHTING BETTER VALUE BETTER OPTIO  
R VALUE BETTER OPTIONS BETTER LIGHTING BETTER VALUE BETT  
NG BETTER VALUE BETTER OPTIONS BETTER LIGHTING BETTER VAL  
LIGHTING BETTER VALUE BETTER OPTIONS BETTER LIGHTING BETT  
IONS BETTER LIGHTING BETTER VALUE BETTER OPTIONS BETT  
VALUE BETTER OPTIONS BETTER LIGHTING BETTER VALUE BETT

## Founded in 1972

The fastest-growing vehicle lighting manufacturer in the U.S., Optronics International attributes its success to delivering better value, better options and better lighting to its customers. Optronics International is a premier worldwide manufacturer of industrial and commercial vehicle safety lighting products. Optronics specializes in interior and exterior LED and incandescent lighting for the HD, trailer, RV, marine, and transit vehicle markets.

## ISO Certified

Optronics is headquartered in Tulsa, Oklahoma, with an ISO/TS 16949:2009 certified manufacturing facility in Annan District, Tainan, Taiwan, and additional manufacturing capabilities in its ISO 9001:2008 certified facility in Muskogee, Oklahoma. The company has an ISO 9001:2008 certified distribution facility in Goshen, Indiana, as well as distribution through its location in Ontario, Canada.

## Lifetime LED Warranty

**ALL Optronics LED lighting** is now covered by a one-diode lifetime warranty that replaces the lamp if even one diode fails.



Muskogee, OK



Goshen, IN



Tainan City, Taiwan



# CONTENTS

All Optronics products conform to DOT/SAE/FMVSS/CMVSS  
108 standards where applicable when applied according  
to federal lighting requirements

<b>LED TRUCK &amp; TRAILER LIGHTING</b>	<b>2 - 168</b>
Headlamps .....	2
FUSION™ Stop/Turn/Tail/Back-Up Lamps.....	4
Sealed Stop/Turn/Tail Lights & Parking/Turn Signals .....	8
Combination Tail Lights & Kits .....	37
Towing Lights.....	59
DOT Compliant Back-Up Lights .....	60
Warning Lights .....	70
Millennium® Series.....	73
Sealed Marker/Clearance Lights .....	80
Surface Mount Marker/Clearance Lights.....	110
Identification Light Bars .....	127
License Plate Lights .....	132
Utility Lights .....	138
Interior & Utility Lights .....	146
Work & Utility Lights .....	158
<b>INCANDESCENT TRUCK &amp; TRAILER LIGHTING</b>	<b>169 - 233</b>
Sealed Stop/Turn/Tail Lights & Parking/Turn Signals .....	169
Combination Tail Lights & Kits .....	173
DOT Compliant Back-Up Lights .....	187
Millennium Series® Marker/Clearance Lights .....	189
Sealed Marker/Clearance Lights .....	191
Surface Mount Marker/Clearance Lights.....	200
Identification Light Bars .....	214
License & Utility Lights .....	217
Utility & Interior Lights .....	227
Work & Ag Lights .....	231
Halogen Lights.....	232
<b>RV LIGHTS &amp; ACCESSORIES</b>	<b>234 - 262</b>
<b>ACCESSORIES - CONSPICUITY, MOUNTING, WIRING</b>	<b>263 - 288</b>
<b>FMVSS LIGHTING REQUIREMENTS</b>	<b>289 - 295</b>
<b>INDEX</b>	<b>296 - 305</b>

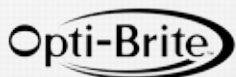

HLL88LB



HLL89HB

## HLL88/89 SERIES

### DOT Compliant High and Low Beam Sealed LED Headlamps

- Replace standard 4" x 6" sealed beam halogen and HID headlamps
- Light output whiter than incandescent for greater visibility
- Long lasting, energy efficient – diodes last up to 50 times longer than incandescent, draw less than 1 amp
- Dual power: use with 12VDC or 24VDC systems
- Hard wired with standard H4 3-blade connector; 16 gauge, 7-inch leads
- Die cast aluminum construction with powder coat finish resists corrosion
- Tough polycarbonate lens with protective coating

BULK P/N	POLYPACK P/N	DESCRIPTION	QTY
<b>LOW BEAM HEADLAMP - 8 DIODES</b>			
HLL88LB	HLL88LBP	12-24VDC Low beam	1
<b>HIGH BEAM HEADLAMP - 8 DIODES</b>			
HLL89HB	HLL89HBP	12-24VDC High beam	1

**HLL88LB:** 12.8VDC - 23.7W / 28VDC - 23.7W

**HLL89HB:** 12.8VDC - 23.7W / 28VDC - 23.7W

**IP67 rating:** protected from dust and capable of withstanding water immersion, offering increased reliability and service life

FMVSS	HL
MATERIALS	Polycarbonate lens, aluminum housing
VOLT/AMP	12.8VDC - 0.85A
WT/DIMS	1.14 lbs. / 6.563" x 4.188" x 3.313"
WARRANTY	Lifetime LED Warranty

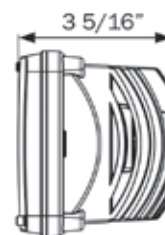
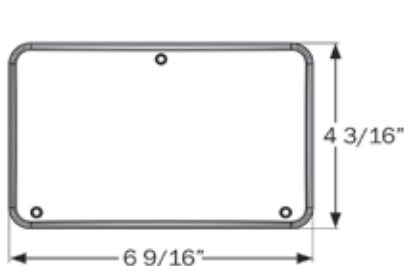

## HLL90 SERIES

### DOT Compliant High/Low Beam Sealed LED Headlamp



- Replace standard 7" sealed beam halogen and HID headlamps
- Light output whiter than incandescent for greater visibility
- Long lasting, energy efficient – diodes last up to 50 times longer than incandescent, draw less than 1 amp
- Dual power: use with 12VDC or 24VDC systems
- Hard wired with standard H4 3-blade connector; 16 gauge, 7-inch leads
- Die cast aluminum construction with powder coat finish resists corrosion
- Tough polycarbonate lens with protective coating



HLL90HLB



BULK P/N	POLYPACK P/N	DESCRIPTION	QTY
<b>HIGH/LOW BEAM HEADLAMP - 16 DIODES</b>			
HLL90HLB	HLL90HLBP	12-24VDC High/low beam	1

**High Beam:** 12.8VDC - 23.68W / 28VDC - 22.4W

**Low Beam:** 12.8VDC - 23.04W / 28VDC - 22.4W

**IP67 rating:** protected from dust and capable of withstanding water immersion, offering increased reliability and service life

FMVSS	HL
MATERIALS	Polycarbonate lens, aluminum housing
VOLT/AMP	12.8VDC - High Beam 1.85A / Low Beam 1.80A
WT/DIMS	2.05 lbs. / 7" x 7" x 2.8"
WARRANTY	Lifetime LED Warranty

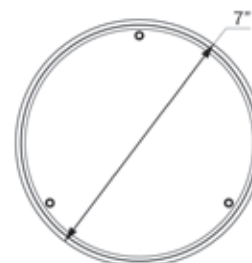

**GloLight**

**FUSION**

## STL201 GLOLIGHT® SERIES GloLight® FUSION™ 4" Round Sealed Stop/Turn/Tail/Back-Up Light with Mounting Flange

### PATENTED TECHNOLOGY

- Sonically sealed, waterproof
- Multi-function: Stop, turn, tail and back-up, all in one light
- Flange mount for security, theft reduction
- Weathertight connection standard



BULK P/N	POLYPACK P/N	DESCRIPTION	QTY
<b>RED STOP/TURN/TAIL/BACK-UP LIGHT - 24 DIODES</b>			
STL201RFMB	STL201RFMBP	Weathertight connection	10
<b>ACCESSORIES</b>			
A45PMB	A45PMBP	Weathertight pigtail, 3-wire	50
A42PMB	A42PMBP	Weathertight pigtail, 2-wire	100

FMVSS	S2 T2 I6 (2)R
MATERIALS	Polycarbonate lens and housing
VOLT/AMP	12.8VDC - .445A Stop/Turn, .265A Tail, .3A Back-Up
WT/DIMS	.38 lbs. / 5.5" x 5.5" x 1.53"
WARRANTY	Lifetime LED Warranty

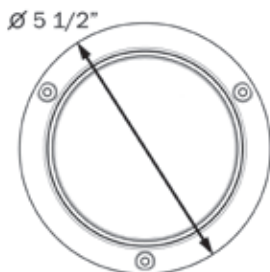
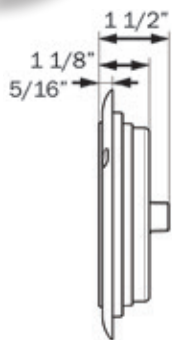

HOLE CUT-OUT: 4.5"



Weathertight connection

## STL201 SERIES FUSION™ 4" Round Sealed Stop/Turn/Tail/Back-Up Light

- Sonically sealed, waterproof
- Multi-function: Stop, turn, tail and back-up, all in one light
- Accepts standard PL-3 plugs



BULK P/N	POLYPACK P/N	DESCRIPTION	QTY
<b>RED STOP/TURN/TAILO/BACK-UP LIGHT - 16 DIODES</b>			
STL201RB	STL201RBP	PL-3 connections	10
<b>ACCESSORIES</b>			
A45GB	A45GBP	Grommet	50
A45PB	A45PBP	Straight pigtail, 3-wire PL-3	100
A47PB	A47PBP	Right angle pigtail, 3-wire PL-3	100
A45CB	A45CBP	Pigtail, 2-wire	100
A49PB	A49PBP	Right angle pigtail, 2-wire	100
BK45BB	BK45BBP	Black steel bracket	10

<b>FMVSS</b>	S2 T2 I6 (2)R
<b>MATERIALS</b>	Polycarbonate lens and housing
<b>VOLT/AMP</b>	12.8VDC - .375A Stop/Turn, .145A Tail, .3A Back-Up
<b>WT/DIMS</b>	.35 lbs. / 4.313" x 4.313" x 2"
<b>WARRANTY</b>	Lifetime LED Warranty

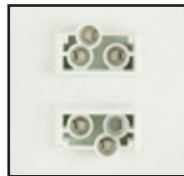

Standard PL3 connections

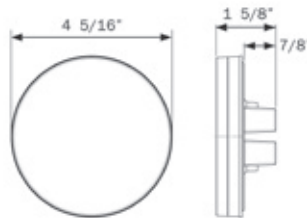

HOLE CUT-OUT: 4.5"



## STL211 SERIES FUSION™ 6" Oval Sealed LED Stop/Turn/Tail/Back-Up Lights



STL211RB



STL211RCB

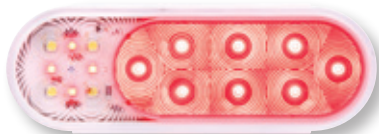

- Sonically sealed, waterproof
- Multi-function: Stop, turn, tail and back-up, all in one light
- Accepts standard PL-3 plugs

BULK P/N	POLYPACK P/N	DESCRIPTION	QTY
<b>RED STOP/TURN/TAIL/BACK-UP LIGHT - 16 DIODES</b>			
STL211RB	STL211RBP	Red lens, PL-3 connection	10
STL211RCB	STL211RCBP	Clear lens, PL-3 connection	10
<b>ACCESSORIES</b>			
A70GB	A70GBP	Grommet, flush mount	50
A45PB	A45PBP	Pigtail, 3-wire	100
A47PB	A47PBP	Right angle pigtail, 3-wire	100
A45CB	A45CBP	Pigtail, 2-wire	100
A49PB	A49PBP	Right angle pigtail, 2-wire	100
A77SB	A77SBP	Grey steel bracket	20
BK70BB	BK70BBP	Black steel bracket	10

<b>FMVSS</b>	S2 T2 I6 (2)R
<b>MATERIALS</b>	Polycarbonate lens and housing
<b>VOLT/AMP</b>	12.8VDC - .375A Stop/Turn, .020A Tail, .242A Back-Up
<b>WT/DIMS</b>	.35 lbs. / 6.438" x 2.313" x 1.50"
<b>WARRANTY</b>	Lifetime LED Warranty

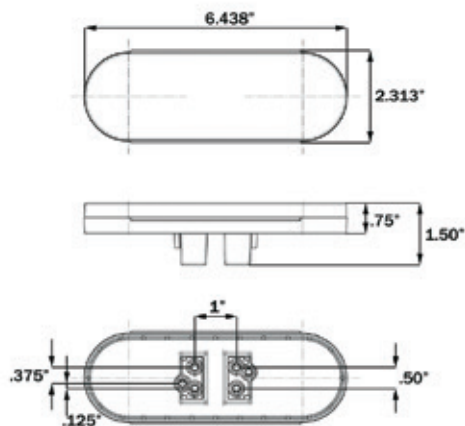

HOLE CUT-OUT:  
6.85" X 2.5"  
(1.25" R)

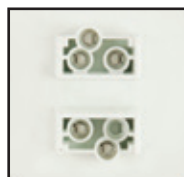

Standard PL3 connections



## STL68 SERIES

### FUSION™ Surface Mount LED Combination Stop/Turn/Tail/Back-Up Light



#### PATENTED TECHNOLOGY

- Sonically sealed, waterproof
- Low profile design—only 1/2" thick
- Surface mount on 9-11/16" centers
- Hard wired with separate ground wire

BULK P/N	POLYPACK P/N	DESCRIPTION	QTY
<b>STOP/TURN/TAIL/BACK-UP LIGHT - 14 DIODES</b>			
STL68RB	STL68RBP	Red, hard wired	10
STL68RPB	STI68RPBP	Red, .180 male bullets	10
<b>ACCESSORIES</b>			
A68SSB	A68SSBP	Stainless steel snap-on ring	20

<b>FMVSS</b>	S2 T2 I6 (2)R
<b>MATERIALS</b>	Polycarbonate lens and housing
<b>VOLT/AMP</b>	12.8VDC - .35A Stop/Turn, .05A Tail, .3A Back-up
<b>WT/DIMS</b>	.275 lbs. / 10.125" x 3.063" x 0.5"
<b>WARRANTY</b>	Lifetime LED Warranty



STL68RB

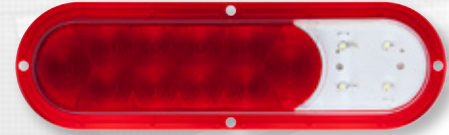

A68SSB

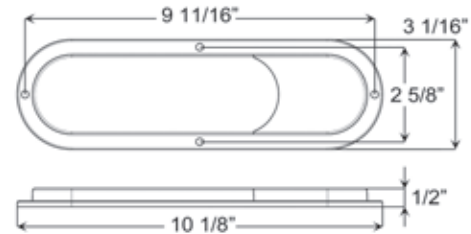

STL68RB

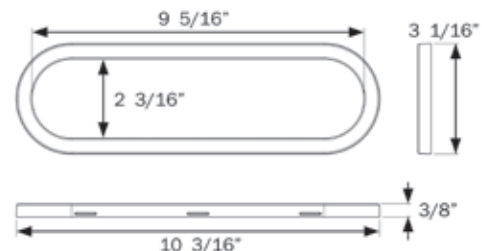

A68SSB

LED FUSION TAIL LIGHTS

## GloLight®

### STL101 GROMMET MOUNT SERIES GloLight® 4" Sealed LED Lights



#### PATENTED TECHNOLOGY

- Sonically sealed, waterproof
- Mount in any 360 degree position
- Available in tinted and clear lens models
- Available with standard PL-3 or optional weathertight connection

BULK P/N	POLYPACK P/N	DESCRIPTION	QTY
<b>RED STOP/TURN/TAIL LIGHT - 21 DIODES</b>			
STL101RB	STL101RBP	PL-3 connection	10
STL101RMB	STL101RMBP	Weathertight connection	10
STL101RCB	STL101RCBP	Clear lens, red diodes, PL-3	10
STL101RCMB	STL101RCMBP	Clear lens, red diodes, weathertight	10
STL101RKB	STL101RKBP	Kit: Red stop/turn/tail light, PL-3 connection, A45GB grommet, A47PB pigtail	10
<b>YELLOW PARKING/TURN SIGNAL - 21 DIODES</b>			
STL101AB	STL101ABP	PL-3 connection	10
STL101ACB	STL101ACBP	Clear lens, yellow diodes, PL-3	10
<b>ACCESSORIES</b>			
A45GB	A45GBP	Grommet	50
A45PB	A45PBP	Pigtail, 3-wire	100
A47PB	A47PBP	Right angle pigtail, 3-wire	100
A45PMB	A45PMBP	Weathertight pigtail	100
AL45PWTB	AL45PWTBP	Weathertight to PL-3 adaptor	50
BK45BB	BK45BBP	Black steel bracket	10
A45BB	A45BBP	Black plastic flange	100
A45SB	A45SBP	Stainless steel mounting flange	20
A45CGB	A45CGBP	Chrome grommet cover	20
<b>FMVSS</b>	Red S2 T2 I6; Yellow I6 P		
<b>MATERIALS</b>	Polycarbonate lens and housing		
<b>VOLT/AMP</b>	Red: 12.8VDC - .375A Stop/Turn, .145A Tail Yellow: 12.8VDC - .315A Turn, .143A Parking		
<b>WT/DIMS</b>	.35 lbs. / 4.313" dia x 1.375" D		
<b>WARRANTY</b>	Lifetime LED Warranty		

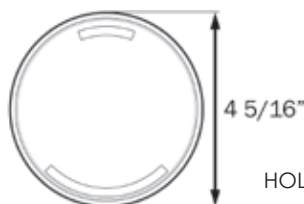

## STL101 FLANGE MOUNT SERIES GloLight® 4" Sealed LED Lights with Mounting Flange

**GloLight®**

### PATENTED TECHNOLOGY

- Sonically sealed, waterproof
- Flange mount for security, theft reduction
- Available in tinted and clear lens models
- Available with standard PL-3 or optional weathertight connection

STOP/TURN

TAIL LIGHT

BULK P/N	POLYPACK P/N	DESCRIPTION	QTY
<b>RED STOP/TURN/TAIL LIGHT - 21 DIODES</b>			
STL101RFB	STL101RFBP	PL-3 connection	10
STL101RFMB	STL101RFMBP	Weathertight connection	10
STL101RCFB	STL101RCFBP	Clear lens, red diodes, PL-3	10
STL101RCFMB	STL101RCFMBP	Clear lens, red diodes, weathertight	10
<b>ACCESSORIES</b>			
A45PB	A45PBP	Pigtail, 3-wire	100
A47PB	A47PBP	Right angle pigtail, 3-wire	100
A45PMB	A45PMBP	Weathertight pigtail	100
AL45PWTB	AL45PWTBP	Weathertight to PL-3 adaptor	50
BK45BB	BK45BBP	Black steel bracket	10
A101TRSSB	A101TRSSBP	Stainless steel trim ring	50
A42GB	A42GBP	Mounting gasket, black	100

<b>FMVSS</b>	Red S2 T2 I6
<b>MATERIALS</b>	Polycarbonate lens and housing
<b>VOLT/AMP</b>	12.8VDC - .375 Stop/Turn, .145A Tail
<b>WT/DIMS</b>	.38 lbs. / 5.48" x 5.48" x 1.53"
<b>WARRANTY</b>	Lifetime LED Warranty

### Industry-standard connections

Easy retrofit of lights to existing harness



Standard PL3 connection

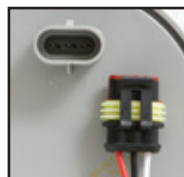

Weathertight connection

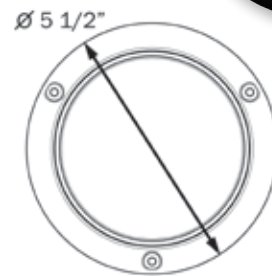
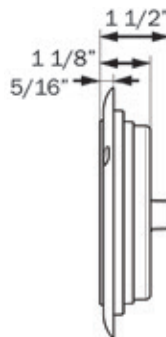

HOLE CUT-OUT: 4.5"

STL101RFB

STL101RCFB

LED SEALED STOP/TURN/TAIL & PARKING/TURN SIGNALS

## GloLight®

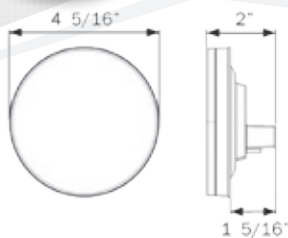

### STL113 SERIES GloLight® 4" Round Sealed LED Lights

PATENTED TECHNOLOGY

- Unique mirrored reflector
- Sonically sealed, waterproof

BULK P/N	POLYPACK P/N	DESCRIPTION	QTY
<b>RED STOP/TURN/TAIL LIGHT - 18 DIODES</b>			
STL113RB	STL113RBP	PL-3 connection	10

<b>FMVSS</b>	S2 T2 I6
<b>MATERIALS</b>	Polycarbonate lens and housing
<b>VOLT/AMP</b>	12.8VDC - .375A Stop/Turn, .145A Tail
<b>WT/DIMS</b>	.35 lbs. / 4.313" x 4.313" x 2"
<b>WARRANTY</b>	Lifetime LED Warranty

## HD500 SERIES



STL513RB



STL513RCB

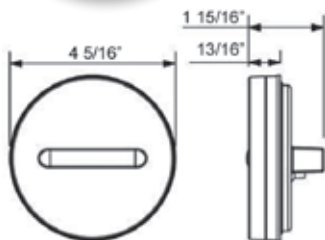

### STL513 Series HD500™ 4" Round Sealed LED Lights

- Sonically sealed, waterproof
- Available in tinted and clear lens models

BULK P/N	POLYPACK P/N	DESCRIPTION	QTY
<b>RED STOP/TURN/TAIL LIGHT - 18 DIODES</b>			
STL513RB	STL513RBP	PL-3 connection	10
STL513RCB	STL513RCBP	Clear lens, red diodes, PL-3	10

<b>FMVSS</b>	S2 T2 I6
<b>MATERIALS</b>	Polycarbonate lens and housing
<b>VOLT/AMP</b>	12.8VDC - .435A Stop/Turn, .042A Tail
<b>WT/DIMS</b>	.287 lbs. / 4.313" x 4.313" x 1.938"
<b>WARRANTY</b>	Lifetime LED Warranty

#### STL113 & STL513 ACCESSORIES

A45GB	A45GBP	PVC grommet, flush mount	50
A45PB	A45PBP	Straight pigtail, 3-wire PL-3	100
A47PB	A47PBP	Right angle pigtail, 3-wire PL-3	100
BK45BB	BK45BBP	Black steel bracket	10
A45BB	A45BBP	Black mounting flange	100
A45SB	A45SBP	Stainless steel mounting flange	20
A45CGB	A45CGBP	Chrome trim ring	20

## STL43 SERIES 4" Round Sealed LED Lights

- Sonically sealed, waterproof
- Kits include grommet and plug
- Mount in any 360 degree position
- Available in 12V and 24V models
- Available with standard PL-3 or optional weathertight connection



STL43RB



STL53RCB

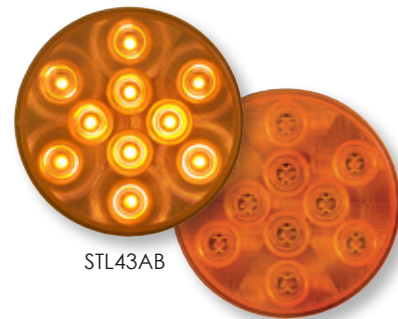

STL43AB

BULK P/N	POLYPACK P/N	DESCRIPTION	QTY
<b>RED STOP/TURN/TAIL LIGHT - 10 DIODES</b>			
STL43RB	STL43RBP	PL-3 connection, 12V	10
STL43RKB	STL43RKBP	Kit with A45GB & A47PB, PL-3, 12V	10
STL43R24B	STL43R24BP	PL-3 connection, 24V	10
STL43RMB	STL43RMBP	Weathertight connection, 12V	10
STL53RCB	STL53RCBP	Clear lens, red diode, PL-3	10
<b>YELLOW PARKING/TURN SIGNAL - 10 DIODES</b>			
STL43AB	STL43ABP	PL-3 connection, 12V	10
STL43A24B	STL43A24BP	PL-3 connection, 24V	10
STL43AKB	STL43AKBP	Kit with A45GB & A47PB, PL-3, 12V	10
<b>ACCESSORIES</b>			
A45GB	A45GBP	Grommet	50
A45PB	A45PBP	Pigtail, 3-wire PL-3	100
A47PB	A47PBP	Right angle pigtail, 3-wire PL-3	100
A45PMB	A45PMBP	Weathertight pigtail	100
AL45PWTB	AL45PWTBP	Weathertight to PL-3 adaptor	50
BK45BB	BK45BBP	Black steel bracket	10
A45BB	A45BBP	Black plastic flange	100
A45SB	A45SBP	Stainless steel mounting flange	20
A45CGB	A45CGBP	Chrome grommet cover	20
<b>RETAIL</b>			
STL43RK		12V kit with A45GB & A47PB, clam	6

<b>FMVSS</b>	Red S T I P2; Yellow I6 P
<b>MATERIALS</b>	Polycarbonate lens and housing
<b>VOLT/AMP</b>	Red: 12.8VDC - .360A Stop/Turn, .030A Tail Yellow: 12.8VDC - .310A Turn, .046A Parking
<b>WT/DIMS</b>	.265 lbs. / 4.313" x 4.313" x 1.938"
<b>WARRANTY</b>	Lifetime LED Warranty

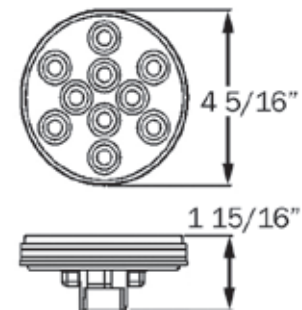

HOLE CUT-OUT: 4.5"

LED SEALED STOP/TURN/TAIL & PARKING/TURN SIGNALS



## STL42 SERIES 4" Round Sealed LED Lights with Mounting Flange

- Sonically sealed, waterproof
- Flange mount for security, theft reduction
- Red available with standard PL-3 or optional weathertight connection



STL42RB



STL42AB



A42GB

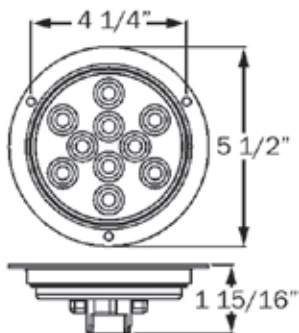

HOLE CUT-OUT: 4.5"

BULK P/N	POLYPACK P/N	DESCRIPTION	QTY
<b>RED STOP/TURN/TAIL LIGHT - 10 DIODES</b>			
STL42RB	STL42RBP	Black flange, PL-3	10
STL42RMB	STL42RMBP	Black flange, weathertight	10
STL42RMBK	STL42RMBKP	Kit: Red stop/turn/tail light with weathertight connection, AL45PWTB pigtail	10
<b>YELLOW PARKING/TURN SIGNAL - 10 DIODES</b>			
STL42AB	STL42ABP	Black flange, PL-3	10
STL42AMB	STL42AMBP	Black flange, weathertight	10
<b>ACCESSORIES</b>			
A45PB	A45PBP	Pigtail, 3-wire PL-3	100
A47PB	A47PBP	Right angle pigtail, 3-wire PL-3	100
A45PMB	A45PMBP	Weathertight pigtail	100
AL45PWTB	AL45PWTBP	Weathertight to PL-3 adaptor	50
BK45BB	BK45BBP	Black steel bracket	10
A42FCB	A42FCBP	Chrome flange cover	100
A5TRSSB	A5TRSSBP	Stainless steel trim ring	100
A42GB	A42GBP	Mounting gasket, black	100
<b>RETAIL</b>			
STL42RS		Light only, clam	6

<b>FMVSS</b>	Red S T I P2; Yellow I6 P
<b>MATERIALS</b>	Polycarbonate lens and housing
<b>VOLT/AMP</b>	Red: 12.8VDC - .413 Stop/Turn, .026A Tail Yellow: 12.8VDC - .310 Turn, .046A Parking
<b>WT/DIMS</b>	.617 lbs. / 5.5" x 5.5" x 1.938"
<b>WARRANTY</b>	Lifetime LED Warranty

## STL43 REFLEX FLANGE SERIES

### 4" Round Sealed LED Lights with Reflex Mounting Flange

- Sonically sealed, waterproof
- Flange mount for security, theft reduction
- Accepts standard PL-3 connector
- Reflex flange meets SAE A for reflector



STL43RBX



STL43ABX

BULK P/N	POLYPACK P/N	DESCRIPTION	QTY
<b>RED STOP/TURN/TAIL LIGHT - 10 DIODES</b>			
STL43RBX	STL43RBXP	Red reflex flange, gasket, PL-3	10
STL43RBHX	STL43RBHXP	Red reflex flange, hard wire, gasket	10
<b>YELLOW PARKING/TURN SIGNAL - 10 DIODES</b>			
STL43ABX	STL43ABXP	Yellow reflex flange, gasket	10
<b>ACCESSORIES</b>			
A45PB	A45PBP	Pigtail, 3-wire PL-3	100
A47PB	A47PBP	Right angle pigtail, 3-wire PL-3	100
<b>RETAIL</b>			
STL43ABXS		Yellow light only, clam	6
STL43RBXS		Red light only, clam	6

<b>FMVSS</b>	Red S T I; Yellow I6 P; Reflex A
<b>MATERIALS</b>	Polycarbonate lens and housing
<b>VOLT/AMP</b>	Red: 12.8VDC - .413 Stop/Turn, .026A Tail Yellow: 12.8VDC - .310 Turn, .046A Parking
<b>WT/DIMS</b>	.397 lbs. / 5.75" x 5.75" x 1.625"
<b>WARRANTY</b>	Lifetime LED Warranty

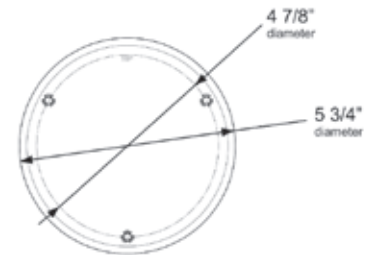

HOLE CUT-OUT: 4.5"

LED SEALED STOP/TURN/TAIL & PARKING/TURN SIGNALS



STL13RB



HOLE CUT-OUT: 4.5"



STL13RFB

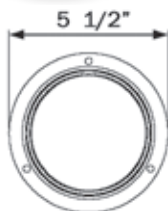

HOLE CUT-OUT: 4.5"

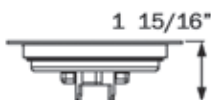

STL13RGB male pin connection

## STL13 SERIES

### FLEET Count™ 4" Round Sealed LED Stop/Turn/Tail Lights

- Sonically sealed, waterproof
- Available in grommet and flange mount models
- Available with standard PL-3, male pin, weathertight or hard wired connections
- Retail kit includes grommet and plug

BULK P/N	POLYPACK P/N	DESCRIPTION	QTY
<b>RED STOP/TURN/TAIL - 7 DIODES</b>			
STL13RB	STL13RBP	PL-3 connection	10
STL13RMB	STL13RMBP	Weathertight connection	10
STL13RGB	STL13RGBP	Male pin connection	10
STL13RH1B	STL13RH1BP	Hard wired, PL-3 female plug	10
STL13RH3B	STL13RH3BP	Hard wired, .180 male bullets	10
STL13RFB	STL13RFBP	Flange, PL-3	10
STL13RFMB	STL13RFMBP	Flange, weathertight	10
STL13RKB	STL13RKBP	Kit: with A45GB grommet and A45PB plug, PL-3 connection	

<b>ACCESSORIES</b>			
A45GB	A45GBP	Grommet	50
A45PB	A45PBP	Pigtail, 3-wire PL-3	100
A47PB	A47PBP	Right angle pigtail, 3-wire PL-3	100
A45PMB	A45PMBP	Weathertight pigtail	100
AL45PWTB	AL45PWTBP	Weathertight to PL-3 adaptor	50
BK45BB	BK45BBP	Black steel bracket	10
A45BB	A45BBP	Black plastic flange	100
A45SB	A45SBP	Stainless steel flange	20
A42FCB	A42FCBP	Chrome flange cover	100
A5TRSSB	A5TRSSBP	Stainless steel trim ring	100
A45CGB	A45CGBP	Chrome grommet cover	20

<b>RETAIL</b>			
STL13RK		Kit with A45GB & A47PB, clam	6
STL13RS		Light only, clam	6
STL13RFS		Flange mount light only, clam	6

<b>FMVSS</b>	S T I
<b>MATERIALS</b>	Polycarbonate lens and housing
<b>VOLT/AMP</b>	12.8VDC - .234A Stop/Turn, .033A Tail
<b>WT/DIMS</b>	STL13 grommet mount: .265 lbs. / 4.31" x 4.31" x 1.81" STL13 flange mount: .275 lbs. / 5.5" x 5.5" x 1.938"
<b>WARRANTY</b>	Lifetime LED Warranty



## STL413 Series FLEET Count™ 4" Round Sealed LED Lights

- Sonically sealed, waterproof
- Mount in any 360° position
- Available in standard PL-3 or optional weathertight connection



STL413RB



BULK P/N	POLYPACK P/N	DESCRIPTION	QTY
<b>RED STOP/TURN/TAIL LIGHT - 4 DIODES</b>			
STL413RB	STL413RBP	PL-3 connection	10
STL413RMB	STL413RMBP	Weathertight connecton	10
<b>ACCESSORIES</b>			
A45GB	A45GBP	Grommet	50
A45PB	A45PBP	Straight pigtail, 3-wire PL-3	100
A47PB	A47PBP	Right angle pigtail, 3-wire PL-3	100
A45PMB	A45PMBP	Weathertight pigtail, 3-wire	50
AL45PWTB	AL45PWTBP	Weathertight pigtail to PL-3	50
A45BB	A45BBP	Black mounting flange	100
A45SB	A45SBP	Stainless steel mounting flange	20
BK45BB	BK45BBP	Black steel bracket	10

<b>FMVSS</b>	S2 T2 I6
<b>MATERIALS</b>	Polycarbonate lens and housing
<b>VOLT/AMP</b>	12.8VDC - .160A Stop/Turn, .008A Tail
<b>WT/DIMS</b>	.265 lbs. / 4.313" x 4.313" x 1.625"
<b>WARRANTY</b>	Lifetime LED Warranty

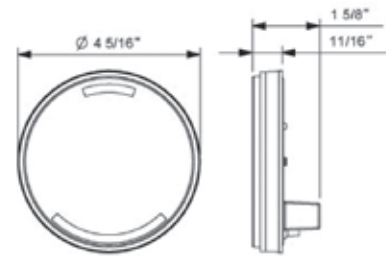

HOLE CUT-OUT: 4.5"

### Industry-standard connections

Easy retrofit of lights to existing harness



Standard PL3 connection



Weathertight connection

LED SEALED STOP/TURN/TAIL & PARKING/TURN SIGNALS



## STL003 Series ONE™ LED 4" Round Sealed Lights

- Sonically sealed, waterproof
- Mount in any 360° position
- Available in grommet and flange mount models with PL-3 and weathertight connections



STL003RB



STL003AB



STL003SRFLB  
PATENT PENDING



BULK P/N	POLYPACK P/N	DESCRIPTION	QTY
<b>RED STOP/TURN/TAIL LIGHT - 1 DIODE</b>			
STL003RB	STL003RBP	PL-3 connection	10
STL003RFB	STL003RFBP	Flange mount, PL-3 connection	10
STL003RFLB	STL003RFLBP	Flange mount, locking PL-3 connection	10
STL003SRFLB	STL003SRFLBP	LampLock™ snap-in flange mount, locking PL-3 connection, adhesive gasket	10
STL003RFMB	STL003RFMBP	Flange mount, weathertight connection	10
STL003RMB	STL003RMBP	Weathertight connection	50
<b>YELLOW PARKING/TURN SIGNAL - 1 DIODE</b>			
STL003AB	STL003ABP	PL-3 connection	50
<b>ACCESSORIES</b>			
A45GB	A45GBP	PVC grommet, flush mount	50
A45PB	A45PBP	Straight pigtail, 3-wire PL-3	100
A47PB	A47PBP	Right angle pigtail, 3-wire PL-3	100
AL45PWTB	AL45PWTBP	Weathertight pigtail, plug to female PL-3	50
A45PMB	A45PMBP	Weathertight 3-wire pigtail, plug to bare wire	50

For more details on mounting and wiring accessories, see Accessories section at back of catalog.

<b>RETAIL</b>			
STL003RK		Kit with grommet and pigtail, clam	6
STL003RS		Light only, clam	6

<b>FMVSS</b>	Red: S T I, Yellow: I P
<b>MATERIALS</b>	Polycarbonate lens and housing
<b>VOLT/AMP</b>	12.8VDC - .25A Stop/Turn, .007A Tail
<b>WT/DIMS</b>	Grommet mount: .35 lbs. / 4.313" x 4.313" (depth varies) Flange mount: .275 lbs. / 5.5" x 5.5" (depth varies)
<b>WARRANTY</b>	Lifetime LED Warranty



## STL23 SERIES

### Miro-Flex™ 4" Round Sealed LED Lights

- Sonically sealed, waterproof
- Mount in any 360 degree position
- Accepts standard PL-3 plugs
- Available in 12V and 24V models

BULK P/N	POLYPACK P/N	DESCRIPTION	QTY
<b>RED STOP/TURN/TAIL - 12 DIODES</b>			
STL23RB	STL23RBP	PL-3 connection, 12V	10
STL23CCRB	STL23CCRBP	Clear lens, red reflector, PL-3, 12V	10
STL23R24B	STL23R24BP	PL-3 connection, 24V	10
<b>YELLOW PARKING/TURN SIGNAL - 16 DIODES</b>			
STL23AB	STL23ABP	PL-3 connection, 12V	10
STL23A24B	STL23A24BP	PL-3 connection, 24V	10
<b>ACCESSORIES</b>			
A45GB	A45GBP	Grommet	50
A45PB	A45PBP	Pigtail, 3-wire PL-3	100
A47PB	A47PBP	Right angle pigtail, 3-wire PL-3	100
BK45BB	BK45BBP	Black steel bracket	10
A45BB	A45BBP	Black plastic flange	100
A45SB	A45SBP	Stainless steel flange	20
A45CGB	A45CGBP	Chrome grommet cover	20

<b>FMVSS</b>	Red S T I; Yellow I P
<b>MATERIALS</b>	Polycarbonate lens and housing
<b>VOLT/AMP</b>	Red: 12.8VDC - .208 Stop/Turn, .013A Tail 24.0VDC - .171 Stop/Turn, .061A Tail Yellow: 12.8VDC - .310 Turn, .046A Parking 24.0VDC - .171 Stop/Turn, .061A Tail
<b>WT/DIMS</b>	.265 lbs. / 4.313" x 4.313" x 1.938"
<b>WARRANTY</b>	Lifetime LED Warranty



STL23RB



STL23CCRB



STL23AB

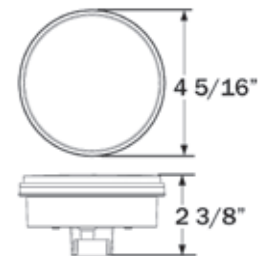

HOLE CUT-OUT: 4.5"

LED SEALED STOP/TURN/TAIL & PARKING/TURN SIGNALS

## HYPERX®

### STL543 SERIES HyperX® 4" Round Sealed LED Stop/Turn/Tail Light

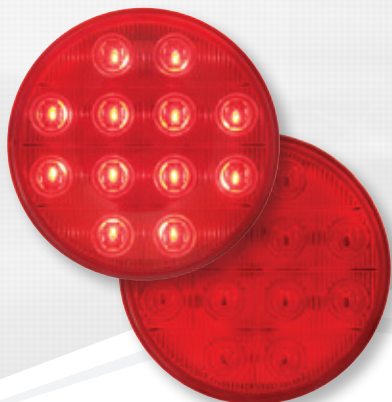

STL543RB

- Sonically sealed, waterproof
- Mount in any 360 degree position
- Accepts standard PL-3 plugs
- 12 diodes and contemporary, automotive style optics

BULK P/N	POLYPACK P/N	DESCRIPTION	QTY
<b>RED STOP/TURN/TAIL - 12 DIODES</b>			
STL543RB	STL543RBP	PL-3 connection	10
<b>ACCESSORIES</b>			
A45GB	A45GBP	Grommet	50
A45PB	A45PBP	Pigtail, 3-wire PL-3	100
A47PB	A47PBP	Right angle pigtail, 3-wire PL-3	100
BK45BB	BK45BBP	Black steel bracket	10
A45BB	A45BBP	Black plastic flange	100
A45SB	A45SBP	Stainless steel flange	20
A45CGB	A45CGBP	Chrome grommet cover	20

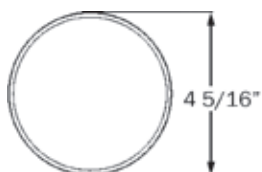

HOLE CUT-OUT: 4.5"

<b>FMVSS</b>	S T I
<b>MATERIALS</b>	Polycarbonate lens and housing
<b>VOLT/AMP</b>	12.8VDC - .208 Stop/Turn, .013A Tail
<b>WT/DIMS</b>	.265 lbs. / 4.313" x 4.313" x 1.938"
<b>WARRANTY</b>	Lifetime LED Warranty

## STL55 SERIES

### High LED Count 4" Round Sealed Lights for Recess Mount

- Sonically sealed, waterproof
- 21 LEDs for high diode count appearance
- Mount in any 360 degree position
- Accepts standard PL-3 plugs; red available with optional weathertight connection



LED SEALED STOP/TURN/TAIL & PARKING/TURN SIGNALS

BULK P/N	POLYPACK P/N	DESCRIPTION	QTY
<b>RED STOP/TURN/TAIL - 21 DIODES</b>			
STL55RB	STL55RBP	Grommet mount, PL-3 connection	10
STL55RFMB	STL55RFMBP	Flange mount, weathertight connection	10
<b>YELLOW PARKING/TURN SIGNAL - 21 DIODES</b>			
STL55AB	STL55ABP	Grommet mount, PL-3 connection	10
<b>ACCESSORIES</b>			
A45GB	A45GBP	Grommet	50
A45PB	A45PBP	Pigtail, 3-wire PL-3	100
A47PB	A47PBP	Right angle pigtail, 3-wire PL-3	100
A45PMB	A45PMBP	Weathertight pigtail	100
AL45PWTB	AL45PWTBP	Weathertight to PL-3 adaptor	50
BK45BB	BK45BBP	Black steel bracket	10
A45BB	A45BBP	Black plastic flange	100
A45SB	A45SBP	Stainless steel flange	20
A45CGB	A45CGBP	Chrome grommet cover	20
<b>FMVSS</b>	Red S T I; Yellow I6 P		
<b>MATERIALS</b>	Polycarbonate lens and housing		
<b>VOLT/AMP</b>	Red: 12.8VDC - .208 Stop/Turn, .013A Tail Yellow: 12.8VDC - .310 Turn, .046A Parking		
<b>WT/DIMS</b>	Grommet mount: .265 lbs. / 4.313" x 4.313" x 1.5" Flange mount: .265 lbs. / 5.5" x 5.5" x 1.5"		
<b>WARRANTY</b>	Lifetime LED Warranty		



STL55RB



STL55RFMB



STL55AB

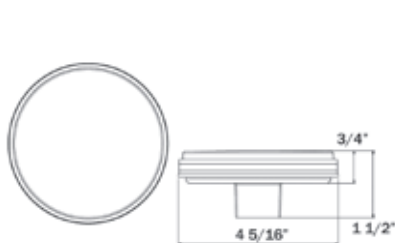

HOLE CUT-OUT: 4.5"

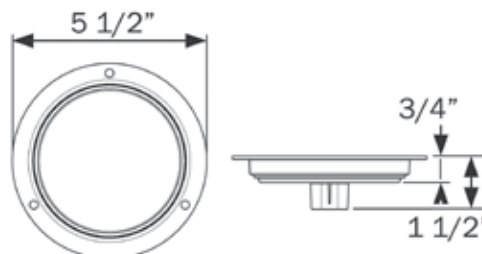

HOLE CUT-OUT: 4.5"



## STL111 GROMMET MOUNT SERIES GloLight® 6" Sealed LED Lights



STL111RB



STL111RCB



STL111AB



STL111ACB



TLL112RK

### PATENTED TECHNOLOGY

- Sonically sealed, waterproof
- Mount in any 360 degree position
- Available in tinted and clear lens models
- Available with standard PL-3 or optional weathertight connection

BULK P/N	POLYPACK P/N	DESCRIPTION	QTY
<b>RED STOP/TURN/TAIL LIGHT - 22 DIODES</b>			
STL111RB	STL111RBP	PL-3	10
STL111RMB	STL111RMBP	Weathertight	10
STL111RHB	STL111RHBP	Hard wired	10
STL111RCB	STL111RCBP	Clear lens, red diodes, PL-3	10
STL111RCMB	STL111RCMBP	Clear lens, red diodes, weathertight	10
<b>YELLOW PARKING/TURN SIGNAL - 22 DIODES</b>			
STL111AB	STL111ABP	PL-3	10
STL111ACB	STL111ACBP	Clear lens, yellow diodes, PL-3	10
<b>ACCESSORIES</b>			
A70GB	A70GBP	Grommet	50
A45PB	A45PBP	Pigtail, 3-wire	100
A47PB	A47PBP	Right angle pigtail, 3-wire	100
A45PMB	A45PMBP	Weathertight pigtail	100
AL45PWTB	AL45PWTBP	Weathertight to PL-3 adaptor	50
BK70BB	BK70BBP	Black steel bracket	10
A77SB	A77SBP	Gray steel bracket	20
<b>RETAIL</b>			
TLL112RK		<b>Try Me</b> kit with (2) ea. STL111RB, A70GB and A47PB, clam	2
<b>FMVSS</b>	Red S2 T2 I6; Yellow I6 P		
<b>MATERIALS</b>	Polycarbonate lens and housing		
<b>VOLT/AMP</b>	Red: 12.8VDC - .59A Stop/Turn, .295A Tail Yellow: 12.8VDC - .515A Turn, .27A Parking		
<b>WT/DIMS</b>	.35 lbs. / 6.5" x 2.25" x 1.75"		
<b>WARRANTY</b>	Lifetime LED Warranty		



HOLE CUT-OUT: 6.85" X 2.5" (1.25" R)

## STL111 FLANGE MOUNT SERIES GloLight® 6" Sealed LED Lights with Mounting Flange

GloLight®

### PATENTED TECHNOLOGY

- Sonically sealed, waterproof
- Recess flange mount for security, theft reduction
- Available in tinted and clear lens models
- Available with standard PL-3 or optional weathertight connection

BULK P/N	POLYPACK P/N	DESCRIPTION	QTY
<b>RED STOP/TURN/TAIL LIGHT - 22 DIODES</b>			
STL111RFB	STL111RFBP	PL-3 connection	10
STL111RFMB	STL111RFMBP	Weathertight connection	10
STL111RCFB	STL111RCFBP	Clear lens, red diodes, PL-3	10
STL111RCFMB	STL111RCFMBP	Clear lens, red diodes, weathertight	10
<b>ACCESSORIES</b>			
A45PB	A45PBP	Pigtail, 3-wire	100
A47PB	A47PBP	Right angle pigtail, 3-wire	100
A45PMB	A45PMBP	Weathertight pigtail	100
AL45PWTB	AL45PWTBP	Weathertight to PL-3 adaptor	50
BK70BB	BK70BBP	Black steel bracket	10
A77SB	A77SBP	Gray steel bracket	20
A111TRSSB	A111TRSSBP	Stainless steel trim ring	50

<b>FMVSS</b>	Red S2 T2 I6
<b>MATERIALS</b>	Polycarbonate lens and housing
<b>VOLT/AMP</b>	12.8VDC - .59 Stop/Turn, .295A Tail
<b>WT/DIMS</b>	.38 lbs. / 7.5" x 3.3" x 1.938"
<b>WARRANTY</b>	Lifetime LED Warranty

TAIL  
LIGHT



STOP/  
TURN



STL111RFB



STL111RCFB

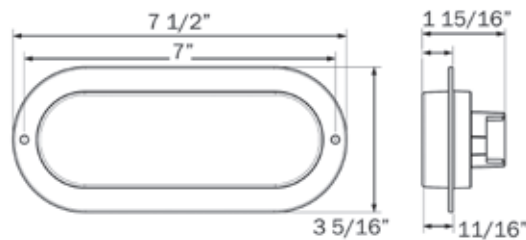

HOLE CUT-OUT: 6.85" X 2.5" (1.25" R)

LED SEALED STOP/TURN/TAIL &  
PARKING/TURN SIGNALS



## STL178 SERIES GloLight® 6" Sealed LED Stop/Turn/Tail Lights for Surface Mount



TAIL  
LIGHT



STOP/  
TURN

STL178RB



STL178RCFPB



STL178RCCFPB

### PATENTED TECHNOLOGY

- Sonically sealed, waterproof
- Mount in any 360 degree position
- Flange surface mount—no panel cut-out required
- Hard wired, with optional molded connectors
- Available in tinted and clear lens models

BULK P/N	POLYPACK P/N	DESCRIPTION	QTY
<b>RED STOP/TURN/TAIL LIGHT - 22 DIODES</b>			
STL178RB	STL178RBP	Hard wired	10
STL178RFPB	STL178RFPBP	Hard wired, female PL-3 plug	10
STL178RCFPB	STL178RCFPBP	Clear lens & glow ring, red diodes, hard wired with female PL-3 connector	10
STL178RCCFPB	STL178RCCFPBP	Clear lens, red diodes, hard wired with female PL-3 connector	10
<b>ACCESSORIES</b>			
BK70BB	BK70BBP	Black steel bracket	10
A77SB	A77SBP	Gray steel bracket	20
A178TRSSB	A178TRSSBP	Stainless steel trim ring	50

FMVSS	S2 T2 I6
MATERIALS	Polycarbonate lens and housing
VOLT/AMP	12.8VDC - .59 Stop/Turn, .295A Tail
WT/DIMS	.38 lbs. / 7.5" x 3.3" x 1.1"
WARRANTY	Lifetime LED Warranty

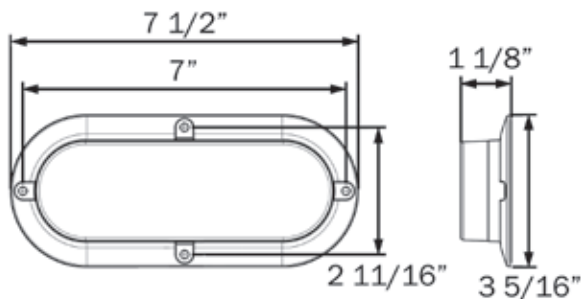



## STL112 SERIES GloLight® 6" Sealed LED Lights

- Unique mirrored reflector
- Sonically sealed, waterproof
- Mount in any 360° position
- Accepts standard PL-3 connector

PATENTED  
TECHNOLOGY

**GloLight®**

BULK P/N	POLYPACK P/N	DESCRIPTION	QTY
<b>RED STOP/TURN/TAIL LIGHT - 22 DIODES</b>			
STL112RB	STL112RBP	PL-3 connection	10
<b>ACCESSORIES</b>			
A70GB	A70GBP	Grommet	50
A45PB	A45PBP	Pigtail, 3-wire	100
A47PB	A47PBP	Right angle pigtail, 3-wire	100
BK70BB	BK70BBP	Black steel bracket	10
A77SB	A77SBP	Gray steel bracket	20
<b>FMVSS</b>	S T I		
<b>MATERIALS</b>	Polycarbonate lens and housing		
<b>VOLT/AMP</b>	12.8VDC - .59A Stop/Turn, .295A Tail		
<b>WT/DIMS</b>	.38 lbs. / 6.438" x 2.313" x 1.938"		
<b>WARRANTY</b>	Lifetime LED Warranty		

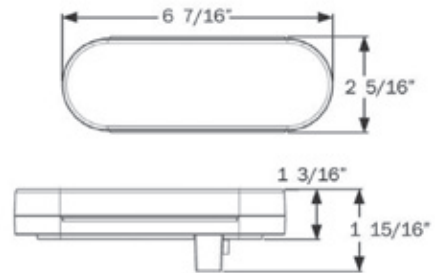

LED SEALED STOP/TURN/TAIL & PARKING/TURN SIGNALS

## STL512 SERIES HD500™ 6" Sealed LED Lights

- Sonically sealed, waterproof
- Available in tinted and clear lens models

BULK P/N	POLYPACK P/N	DESCRIPTION	QTY
<b>RED STOP/TURN/TAIL LIGHT - 18 DIODES</b>			
STL512RB	STL512RBP	PL-3 connection	10
STL512RCB	STL512RCBP	Weathertight connection	10
<b>ACCESSORIES</b>			
A70GB	A70GBP	Grommet	50
A45PB	A45PBP	Pigtail, 3-wire	100
A47PB	A47PBP	Right angle pigtail, 3-wire	100
BK70BB	BK70BBP	Black steel bracket	10
<b>FMVSS</b>	S T I		
<b>MATERIALS</b>	Polycarbonate lens and housing		
<b>VOLT/AMP</b>	12.8VDC - .294A Stop/Turn, .024A Tail		
<b>WT/DIMS</b>	.262 lbs. / 6.50" x 2.313" x 1.84"		
<b>WARRANTY</b>	Lifetime LED Warranty		

**HD500**  
SERIES

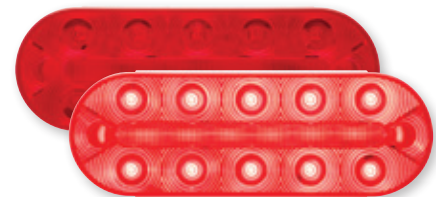

STL512RB



STL512RCB

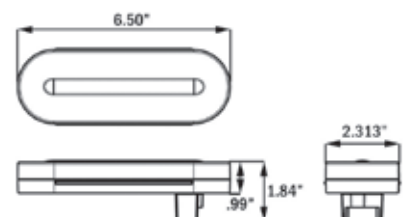



STL72RB

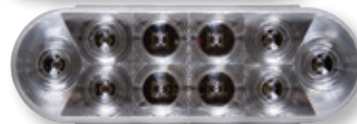

STL82RCB



STL72AB

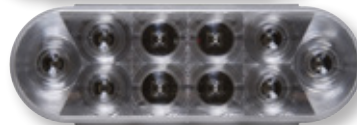

STL72CAB

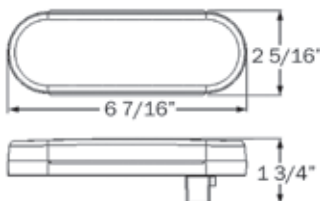

HOLE CUT-OUT: 6.85" X 2.5" (1.25" R)

## STL72/82 SERIES 6" Oval Sealed LED Lights

- Sonically sealed, waterproof
- Kits include grommet and plug
- Mount in any 360 degree position
- Available with standard PL-3 or optional weathertight connection

BULK P/N	POLYPACK P/N	DESCRIPTION	QTY
<b>RED STOP/TURN/TAIL LIGHT - 10 DIODES</b>			
STL72RB	STL72RBP	PL-3 connection	10
STL72RKB	STL72RKBP	Kit with A70GB, PL-3	10
STL74RBK	STL74RBKP	Kit with A70GB & A47PB, PL-3	50
STL74RKB	STL74RKBP	Kit with A70GB & A45PB, PL-3	10
STL72RMB	STL72RMBP	Weathertight connection	10
STL82RCB	STL82RCBP	Clear lens, red diodes, PL-3	10
<b>YELLOW PARKING/TURN SIGNAL - 10 DIODES</b>			
STL72AB	STL72ABP	PL-3	10
STL72AMB	STL72AMBP	Weathertight connection	10
STL72CAB	STL72CABP	Clear lens, amber diodes, PL-3	10
<b>ACCESSORIES</b>			
A70GB	A70GBP	Grommet	50
A45PB	A45PBP	Pigtail, 3-wire PL-3	100
A47PB	A47PBP	Right angle pigtail, 3-wire PL-3	100
A45PMB	A45PMBP	Weathertight pigtail	100
AL45PWTB	AL45PWTBP	Weathertight to PL-3 adaptor	50
BK70BB	BK70BBP	Black steel bracket	10
A77SB	A77SBP	Gray steel bracket	20
<b>RETAIL</b>			
STL72RK		12V kit with A70GB & A47PB, clam	6
STL72RS		12V, clam	6

<b>FMVSS</b>	Red I6 P3 S2 T2; Yellow I6 P
<b>MATERIALS</b>	Polycarbonate lens and housing
<b>VOLT/AMP</b>	Red: 12.8VDC - .243A Stop/Turn, .046A Tail Yellow: 12.8VDC - .275A Turn, .042A Parking
<b>WT/DIMS</b>	.309 lbs. / 6.438" x 2.313" x 1.75"
<b>WARRANTY</b>	Lifetime LED Warranty

## STL78/88 SERIES 6" Oval Sealed LED Lights for Surface Mount

- Sonically sealed, waterproof
- Mount in any 360 degree position
- Flange surface mount—no panel cut-out required
- Hard wired, with optional molded connectors

BULK P/N	POLYPACK P/N	DESCRIPTION	QTY
<b>RED STOP/TURN/TAIL LIGHT - 10 DIODES</b>			
STL78RB	STL78RBP	Hard wired	10
STL78RPG	STL78RPGP	.180 male bullets	10
STL78REZB	STL78REZBP	3-way female PL-3 plug	10
STL78RLPB	STL78RLPBP	Low profile 9/16" thick, female PL-3 plug, gasket included	10
STL88RCB	STL88RCBP	Clear lens, red diodes, hard wired	10
STL88RCPG	STL88RCPGP	Clear lens, red diodes, 3-way female PL-3 plug	10
<b>YELLOW PARKING/TURN SIGNAL - 10 DIODES</b>			
STL78AB	STL78ABP	Hard wired	10
<b>ACCESSORIES</b>			
A78CB1	A78CB1P	Chrome flange cover	25
A78RXB	A78RXBP	Red reflex flange cover & gasket	25
<b>RETAIL</b>			
STL78RK		Single light, clam	6



STL78RB



STL88RCB

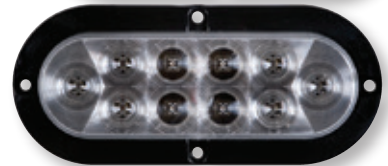

STL78AB

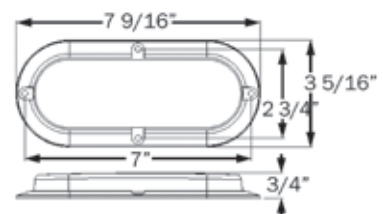

<b>FMVSS</b>	Red I6 P3 S2 T2; Yellow I6 P
<b>MATERIALS</b>	Polycarbonate lens and housing
<b>VOLT/AMP</b>	Red: 12.8VDC - .243A Stop/Turn, .046A Tail Yellow: 12.8VDC - .275A Turn, .042A Parking
<b>WT/DIMS</b>	STL78/88: .265 lbs. / 7.563" x 3.313" x 0.750" STL78RLPB: .260 lbs. / 7.563" x 3.313" x .563"
<b>WARRANTY</b>	Lifetime LED Warranty

LED SEALED STOP/TURN/TAIL & PARKING/TURN SIGNALS



STL12RB

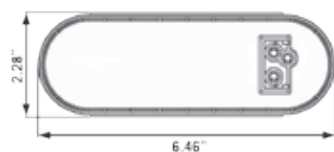

HOLE CUT-OUT: 6.85" X 2.5" (1.25" R)



TLL12RK

## STL12 SERIES FLEET Count™ 6" Oval Sealed LED Stop/Turn/Tail Lights

- Sonically sealed, waterproof
- Available with standard PL-3 or optional weathertight connection
- Retail kit includes light, grommet and plug

BULK P/N	POLYPACK P/N	DESCRIPTION	QTY
<b>RED STOP/TURN/TAILO - 6 DIODES</b>			
STL12RB	STL12RBP	PL-3 connection	10
STL12RMB	STL12RMBP	Weathertight connection	10
STL12RK2B	-	Kit: STL12RB, A45PB, & A60GB	10
STL12RKB	-	Kit: STL12RB, A45PB, & A70GB	10
<b>ACCESSORIES</b>			
A70GB	A70GBP	Grommet	50
A45PB	A45PBP	Pigtail, 3-wire PL-3	100
A47PB	A47PBP	Right angle pigtail, 3-wire PL-3	100
A45PMB	A45PMBP	Weathertight pigtail	100
AL45PWTB	AL45PWTBP	Weathertight to PL-3 adaptor	50
BK70BB	BK70BBP	Black steel bracket for STL12RB	10
A77SB	A77SBP	Gray steel bracket for STL12RB	20
<b>RETAIL</b>			
STL12RK		Kit with A70GB & A47PB, clam	6
STL12RS		Light only, clam	6
TLL12RK		Kit with (2) each STL12RB, A70GB & A47PB, clam	2

FMVSS	S T I
MATERIALS	Polycarbonate lens and housing
VOLT/AMP	12.8VDC - .161A Stop/Turn, .007A Tail
WT/DIMS	.375 lbs. / 6.5" x 2.25" x 1.75"
WARRANTY	Lifetime LED Warranty

## STL73 SERIES

### FLEET Count™ 6" Oval Sealed LED Stop/Turn/Tail Lights

- Sonically sealed, waterproof
- Flange surface mount is hard wired requiring no panel cut-out; includes ground

BULK P/N	POLYPACK P/N	DESCRIPTION	QTY
<b>RED STOP/TURN/TAIL - 6 DIODES</b>			
STL73RB	STL73RBP	Flange surface mount, hard wired	10
STL73RKB	STL73RKBP	Kit with STL73RB and A73GB gasket	10
<b>ACCESSORIES</b>			
A78CB1	A78CB1P	Chrome flange cover	25
<b>RETAIL</b>			
STL73RK		Kit with STL73RB and A78CB1, clam	6
<b>FMVSS</b>	S T I		
<b>MATERIALS</b>	Polycarbonate lens and housing		
<b>VOLT/AMP</b>	12.8VDC - .161A Stop/Turn, .007A Tail		
<b>WT/DIMS</b>	.287 lbs. / 7.563" x 3.313" x 0.75"		
<b>WARRANTY</b>	Lifetime LED Warranty		



STL73RB



A78CB1

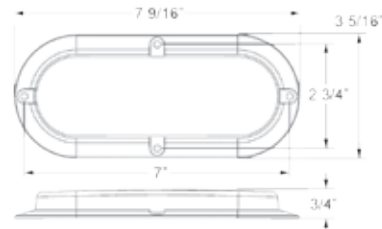

LED SEALED STOP/TURN/TAIL & PARKING/TURN SIGNALS

## STL412 SERIES

### FLEET Count™ 6" Sealed LED Lights

- Sonically sealed, waterproof
- Mount in any 360° position
- Accepts standard PL-3 connector

BULK P/N	POLYPACK P/N	DESCRIPTION	QTY
<b>RED STOP/TURN/TAIL LIGHT - 4 DIODES</b>			
STL412RB	STL412RBP	PL-3 connection	10
<b>ACCESSORIES</b>			
A70GB	A70GBP	Grommet	50
A45PB	A45PBP	Pigtail, 3-wire	100
A47PB	A47PBP	Right angle pigtail, 3-wire	100
BK70BB	BK70BBP	Black steel bracket	10
A77SB	A77SBP	Gray steel bracket	20
<b>FMVSS</b>	S T I		
<b>MATERIALS</b>	Polycarbonate lens and housing		
<b>VOLT/AMP</b>	12.8VDC - .161A Stop/Turn, .007A Tail		
<b>WT/DIMS</b>	.375 lbs. / 6.438" x 2.313" x 1.75"		
<b>WARRANTY</b>	Lifetime LED Warranty		

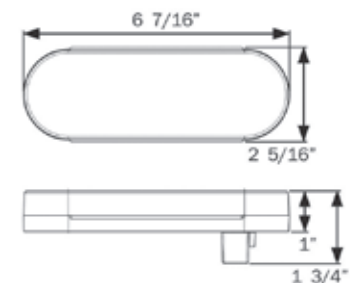
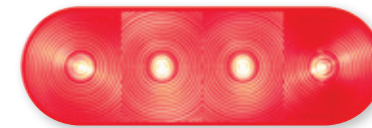



## STL002 SERIES ONE™ 6" Sealed LED Lights

- Sonically sealed, waterproof
- Mount in any 360 degree position
- Available in grommet and flange mount models



STL002RB



STL002AB



STL002RFB

BULK P/N	POLYPACK P/N	DESCRIPTION	QTY
<b>RED STOP/TURN/TAILO LIGHT - 1 DIODE</b>			
STL002RB	STL002RBP	PL-3 connection	50
STL002RMB	STL002RMBP	Weathertight connection	50
STL002RFB	STL002RFBP	Flange mount, PL-3 connection	10
STL002RK2B	STL002RK2BP	Kit with A60GB and A47PB, PL-3	10
<b>YELLOW PARKING/TURN SIGNAL - 1 DIODE</b>			
STL002AB	STL002ABP	PL-3 connection	50
<b>ACCESSORIES</b>			
A70GB	A70GBP	Grommet	50
A45PB	A45PBP	Pigtail, 3-wire	100
A47PB	A47PBP	Right angle pigtail, 3-wire	100
BK70BB	BK70BBP	Black steel bracket	10
<b>RETAIL</b>			
STL002RK		Kit with grommet and plug, clam	6
STL002RS		Grommet mount light only, clam	6
TLL002RK		Set with (2) each STL002RB, A70GB and A47PB, clam	2



HOLE CUT-OUT: 6.85" x 2.5" (1.25" R)

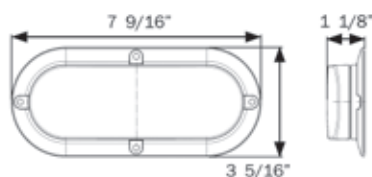

NO PANEL CUT-OUT REQUIRED

<b>FMVSS</b>	Red: S2 T2 I6, Yellow: I6 P
<b>MATERIALS</b>	Polycarbonate lens and housing
<b>VOLT/AMP</b>	12.8VDC - .25A Stop/Turn, .007A Tail
<b>WT/DIMS</b>	Grommet mount: .262 lbs. / 6.50" x 2.313" x 1.875" Flange mount: .262 lbs. / 7.563" x 3.313" x 1.125"
<b>WARRANTY</b>	Lifetime LED Warranty

## STL22 SERIES

### Miro-Flex™ 6" Oval Sealed LED Lights

- Sonically sealed, waterproof
- Mount in any 360 degree position
- Accepts standard PL-3 plugs
- Available with tinted or clear lens and chrome or tinted reflector

BULK P/N	POLYPACK P/N	DESCRIPTION	QTY
<b>RED STOP/TURN/TAIL - 12 DIODES</b>			
STL22RB	STL22RBP	PL-3 connection	10
STL22RBH	STL22RBHP	Hard wired	10
STL22CCRB	STL22CCRBP	Clear lens, red reflector, PL-3	10
STL22RCB	STL22RCBP	Clear lens, PL-3	10
<b>YELLOW PARKING/TURN SIGNAL - 16 DIODES</b>			
STL22AB	STL22ABP	PL-3 connection	10
STL22CCAB	STL22CCABP	Clear lens, yellow reflector, PL-3	10
<b>ACCESSORIES</b>			
A70GB	A70GBP	Grommet	50
A45PB	A45PBP	Pigtail, 3-wire PL-3	100
A47PB	A47PBP	Right angle pigtail, 3-wire PL-3	100
BK70BB	BK70BBP	Black steel bracket	10
A77SB	A77SBP	Gray steel bracket	20
<b>RETAIL</b>			
TLL22RK		Set with (2) each STL22RCB, A70GB & A47PB, clam	2

<b>FMVSS</b>	Red S T I; Yellow I P
<b>MATERIALS</b>	Polycarbonate lens and housing
<b>VOLT/AMP</b>	Red: 12.8VDC - .161 Stop/Turn, .009A Tail Yellow: 12.8VDC - .181 Turn, .023A Parking
<b>WT/DIMS</b>	.397 lbs. / 6.5" x 2.313" x 2.188"
<b>WARRANTY</b>	Lifetime LED Warranty

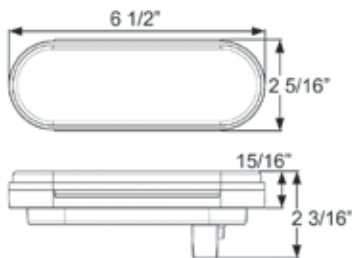

HOLE CUT-OUT:  
6.85" X 2.5" (1.25" R)



TLL22RK



STL22RB



STL22CCRB



STL22RCB



STL22AB



STL22CCAB

## HYPERX<sup>®</sup>



STL572RB



STL572AB

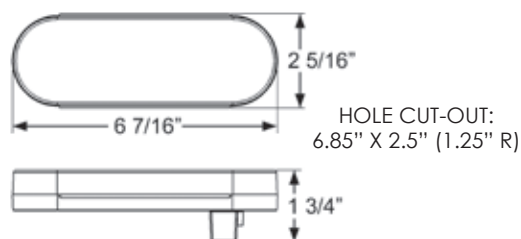

## STL572 SERIES

### HyperX<sup>®</sup> 6" Oval Sealed LED Lights

- Sonically sealed, waterproof
- Accepts standard PL-3 plugs

BULK P/N	POLYPACK P/N	DESCRIPTION	QTY
<b>RED STOP/TURN/TAIL - 12 DIODES</b>			
STL572RB	STL572RBP	PL-3 connection	10
<b>YELLOW PARKING/TURN SIGNAL - 12 DIODES</b>			
STL572AB	STL572ABP	PL-3 connection	10

<b>FMVSS</b>	Red S T I; Yellow I P
<b>MATERIALS</b>	Polycarbonate lens and housing
<b>VOLT/AMP</b>	Red: 12.8VDC - .174 Stop/Turn, .007A Tail Yellow: 12.8VDC - .261 Turn, .013A Parking
<b>WT/DIMS</b>	.331 lb. / 6.438" x 2.313" x 1.75"
<b>WARRANTY</b>	Lifetime LED Warranty

## Optronics LED



STL70RB



STL70AB

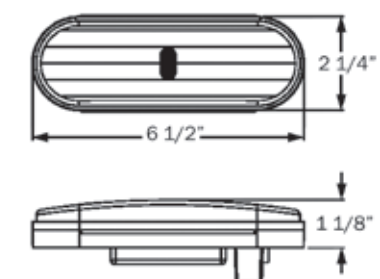

## STL70 SERIES

### High Diode Count 6" Oval Sealed LED Lights

- Sonically sealed, waterproof
- 48-56 LEDs for high diode count appearance
- Accepts standard PL-3 plugs



BULK P/N	POLYPACK P/N	DESCRIPTION	QTY
<b>RED STOP/TURN/TAIL - 48 DIODES</b>			
STL70RB	STL70RBP	PL-3 connection	10
<b>YELLOW PARKING/TURN SIGNAL - 56 DIODES</b>			
STL70AB	STL70ABP	PL-3 connection	10

<b>FMVSS</b>	Red S T I P2; Yellow I P2 P
<b>MATERIALS</b>	Polycarbonate lens and housing
<b>VOLT/AMP</b>	Red: 12.8VDC - .362 Stop/Turn, .013A Tail Yellow: 12.8VDC - .400 Turn, .046A Parking
<b>WT/DIMS</b>	.353 lbs. / 6.5" x 2.25" x 1.125"
<b>WARRANTY</b>	Lifetime LED Warranty

<b>STL572 &amp; STL70 ACCESSORIES</b>			
A70GB	A70GBP	Grommet	50
A45PB	A45PBP	Pigtail, 3-wire PL-3	100
A47PB	A47PBP	Right angle pigtail, 3-wire PL-3	100
BK70BB	BK70BBP	Black steel bracket	10
A77SB	A77SBP	Gray steel bracket	20



## STL175 SERIES

### GloLight® 6" Oval Sealed LED E Rated Mid-Ship Turn Signal and Intermediate Marker Light

**GloLight®**

#### PATENTED TECHNOLOGY

- Sonically sealed, waterproof
- SAE "E" compliant—meets California requirements for mid-ship turn signal on vehicles 30 feet or longer
- Weathertight connection standard

BULK P/N	POLYPACK P/N	DESCRIPTION	QTY
<b>E RATED - 10 DIODES</b>			
STL175AMFB	STL175AMFBP	Weathertight connection	10
<b>ACCESSORIES</b>			
A45PMB	A45PMBP	Weathertight pigtail	100
AL45PWTB	AL45PWTBP	Weathertight to PL-3 adaptor	50
BK70BB	BK70BBP	Black steel bracket	10
A77SB	A77SBP	Gray steel bracket	20
A7TRSSB	A7TRSSBP	Stainless steel flange cover	20

**FMVSS** E P2

**MATERIALS** Polycarbonate lens and housing

**VOLT/AMP** 12.8VDC - .201A Turn, .054 Marker

**WT/DIMS** Grommet Mount: .309 lbs. / 6.5" x 2.375" x 2.5"  
Flange Mount: .309 lbs. / 7.875" x 3.313" x 2.5"

**WARRANTY** Lifetime LED Warranty



Marker



Turn

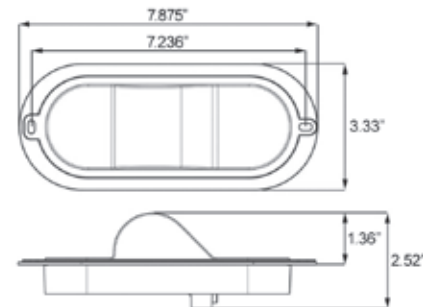

LED SEALED STOP/TURN/TAIL & PARKING/TURN SIGNALS



## STL71/75 SERIES 6" Oval Sealed LED E Rated Mid-Ship Turn Signal and Intermediate Marker Light

- Sonically sealed, waterproof
- SAE "E" compliant—meets California requirements for mid-ship turn signal on vehicles 30 feet or longer
- Weathertight connection standard



STL71AMB



HOLE CUT-OUT: 6.85" X 2.5" (1.25" R)



STL75AMFB

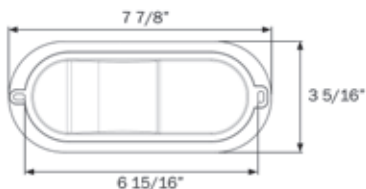

HOLE CUT-OUT: 6.85" X 2.5" (1.25" R)

BULK P/N	POLYPACK P/N	DESCRIPTION	QTY
<b>E RATED - 10 DIODES</b>			
STL71AMB	STL71AMBP	Weathertight connection	10
STL75AMFB	STL75AMFBP	Flange, weathertight connection	10
<b>ACCESSORIES</b>			
A70GB	A70GBP	Grommet	50
A45PMB	A45PMBP	Weathertight pigtail	100
AL45PWTB	AL45PWTBP	Weathertight to PL-3 adaptor	50
BK70BB	BK70BBP	Black steel bracket	10
A77SB	A77SBP	Gray steel bracket	20
A7TRSSB	A7TRSSBP	Stainless steel flange cover	20

<b>FMVSS</b>	E P2
<b>MATERIALS</b>	Polycarbonate lens and housing
<b>VOLT/AMP</b>	12.8VDC - .201A Turn, .054 Marker
<b>WT/DIMS</b>	Grommet Mount: .309 lbs. / 6.5" x 2.375" x 2.5" Flange Mount: .309 lbs. / 7.875" x 3.313" x 2.5"
<b>WARRANTY</b>	Lifetime LED Warranty

## STL75 SERIES

### 6" Oval Sealed LED E2 Rated Mid-Ship Turn Signal and Intermediate Marker Light

- Sonically sealed, waterproof
- "E2" rated for vehicles less than 30 feet in length
- Available with standard PL-3 or optional weathertight connection



STL75AB

BULK P/N	POLYPACK P/N	DESCRIPTION	QTY
<b>E2 RATED - 9 DIODES</b>			
STL75AB	STL75ABP	PL-3 connection	10
STL75AMB	STL75AMB	Weathertight connection	10
<b>ACCESSORIES</b>			
A70GB	A70GBP	Grommet	50
A45PB	A45PBP	Pigtail, 3-wire PL-3	100
A47PB	A47PBP	Right angle pigtail, 3-wire PL-3	100
A45PMB	A45PMBP	Weathertight pigtail	100
AL45PWTB	AL45PWTBP	Weathertight to PL-3 adaptor	50
BK70BB	BK70BBP	Black steel bracket	10
A77SB	A77SBP	Gray steel bracket	20

<b>FMVSS</b>	A E2 P2
<b>MATERIALS</b>	Polycarbonate lens and housing
<b>VOLT/AMP</b>	12.8VDC - .141A Turn, .060 Marker
<b>WT/DIMS</b>	PL-3 Connection: .309 lbs. / 6.5" x 2.313" x 2.75" Weathertight: .309 lbs. / 6.5" x 2.313" x 2.58"
<b>WARRANTY</b>	Lifetime LED Warranty

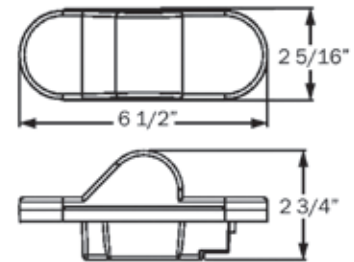

HOLE CUT-OUT: 6.85" X 2.5" (1.25" R)

LED SEALED STOP/TURN/TAIL & PARKING/TURN SIGNALS



## STL133 SERIES GloLight® Sealed Rectangular LED Stop/Turn/Tail Lights

STOP/TURN



TAIL LIGHT



### PATENTED TECHNOLOGY

- Sonically sealed, waterproof
- Accepts standard PL-3 plugs

BULK P/N	POLYPACK P/N	DESCRIPTION	QTY
<b>RED STOP/TURN/TAILO - 14 DIODES</b>			
STL133RB	STL133RBP	Grommet mount, PL-3 connection	10
<b>ACCESSORIES</b>			
A33GB	A33GBP	Grommet	50
A45PB	A45PBP	Pigtail, 3-wire PL-3	100
A47PB	A47PBP	Right angle pigtail, 3-wire PL-3	100

<b>FMVSS</b>	S2 T2 I6
<b>MATERIALS</b>	Polycarbonate lens and housing
<b>VOLT/AMP</b>	12.8VDC - .278A Stop/Turn, .135A Tail
<b>WT/DIMS</b>	.309 lbs. / 5.313" x 3.438" x 1.813"
<b>WARRANTY</b>	Lifetime LED Warranty

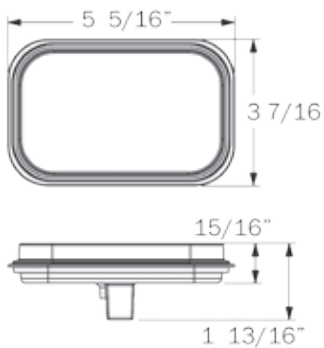

STL133RB

## STL33 SERIES Sealed Rectangular LED Stop/Turn/Tail Lights

- Sonically sealed, waterproof
- Accepts standard PL-3 plugs
- Available in grommet mount and flange mount models
- Flange mount model is hard wired, with female PL-3 plug

BULK P/N	POLYPACK P/N	DESCRIPTION	QTY
<b>RED STOP/TURN/TAIL - 12 DIODES</b>			
STL33RB	STL33RBP	Grommet mount, PL-3 connection	10
STL34RB	STL34RBP	Kit: STL33RB, A33GB & A45PB	10
STL33RFB	STL33RFBP	Flange mount, hard wired, PL-3 plug	10
<b>ACCESSORIES</b>			
A33GB	A33GBP	Grommet	50
A45PB	A45PBP	Pigtail, 3-wire PL-3	100
A47PB	A47PBP	Right angle pigtail, 3-wire PL-3	100

<b>FMVSS</b>	S2 T2 I6
<b>MATERIALS</b>	Polycarbonate lens and housing
<b>VOLT/AMP</b>	12.8VDC - .405 Stop/Turn, .038A Tail
<b>WT/DIMS</b>	STL33RB: .309 lbs. / 5.313" x 3.438" x 1.938" STL33RFB: .287 lbs. / 6.125" x 4.25" x .875"
<b>WARRANTY</b>	Lifetime LED Warranty



STL33RB



STL33RFB

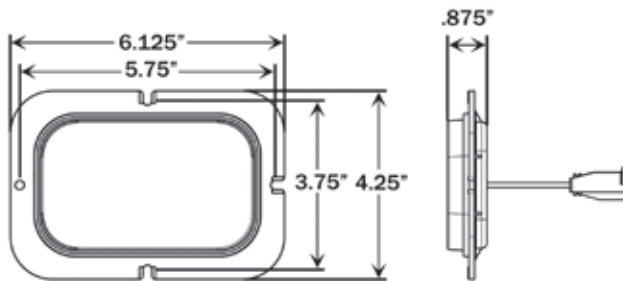

STL33RFB

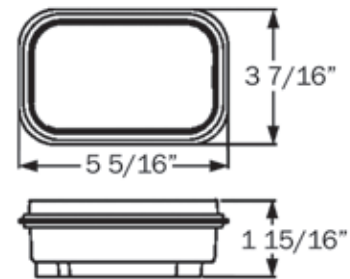

STL33RB

HOLE CUT-OUT: 5.453" X 3.578" (1" R)

LED SEALED STOP/TURN/TAIL & PARKING/TURN SIGNALS



## STL35 SERIES Sealed Rectangular LED Lights

- Sonically sealed, waterproof
- Accepts standard PL-3 plugs
- Available in red and amber
- Miro-Flex™ combines smooth lens and faceted reflector design for a contemporary automotive appearance



STL35RB



STL35AB

BULK P/N	POLYPACK P/N	DESCRIPTION	QTY
<b>RED STOP/TURN/TAIL - 16 DIODES</b>			
STL35RB	STL35RBP	PL-3 connection	10
<b>YELLOW PARKING/TURN SIGNAL - 16 DIODES</b>			
STL35AB	STL35ABP	PL-3 connection	10
<b>ACCESSORIES</b>			
A33GB	A33GBP	Grommet	50
A45PB	A45PBP	Pigtail, 3-wire PL-3	100
A47PB	A47PBP	Right angle pigtail, 3-wire PL-3	100

<b>FMVSS</b>	STL35RB:	S2 T2 I6
	STL35AB:	I6 P
<b>MATERIALS</b>	Polycarbonate lens and housing	
<b>VOLT/AMP</b>	STL35RB:	12.8VDC - .301 Stop/Turn, .020A Tail
	STL35AB:	12.8VDC - .301 Turn, .020A Parking
<b>WT/DIMS</b>	.309 lbs. / 5.313" x 3.438" x 2.313"	
<b>WARRANTY</b>	Lifetime LED Warranty	

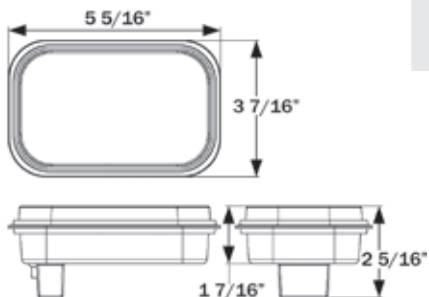

HOLE CUT-OUT: 5.453" X 3.578" (1" R)

## STL63 SERIES

### Thinline LED Stop/Turn/Tail Lights



- Sonically sealed, waterproof
- Low profile design—only 5/8" thick
- Surface mount on 14-1/8" centers
- Hard wired with separate ground wire
- Available with tinted or clear lens



STL63RB



STL63CRB



BULK P/N	POLYPACK P/N	DESCRIPTION	QTY
<b>RED STOP/TURN/TAIL LIGHTS - 9 DIODES</b>			
STL63RB	STL63RBP	Red	10
STL63CRB	STL63CRBP	Clear lens, red diodes	10

<b>FMVSS</b>	S T I
<b>MATERIALS</b>	Polycarbonate lens and housing
<b>VOLT/AMP</b>	12.8VDC - .350 Stop/Turn, .022A Tail
<b>WT/DIMS</b>	.275 lbs. / 15" x 1.625" x .75"
<b>WARRANTY</b>	Lifetime LED Warranty

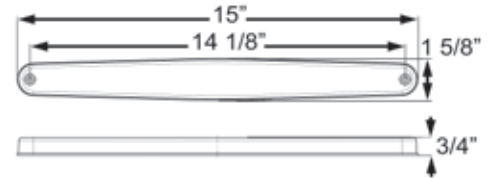

LED COMBINATION  
TAIL LIGHTS & KITS



STL69RB



STL69RCB

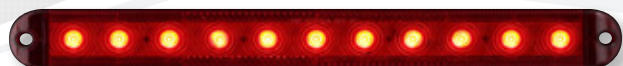

STL69RRXB

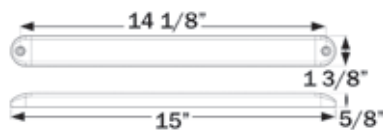

STL69RB/RCB

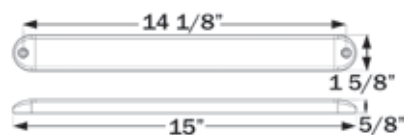

STL69RRXB

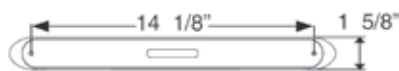

A69CB

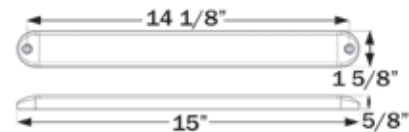
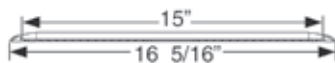

A69RCB

## STL69 SERIES Thinline Sealed LED Stop/Turn/Tail Lights

- Sonically sealed, waterproof
- Low profile design—only 5/8" thick
- Surface mount on 14-1/8" centers; optional gasket
- STL69RRXB meets SAE S2T216 for over 80" wide vehicles and has built-in reflex meeting SAE A
- Hard wired with separate ground wire; available with optional molded plugs

BULK P/N	POLYPACK P/N	DESCRIPTION	QTY
<b>RED STOP/TURN/TAIL LIGHTS - 11 DIODES</b>			
STL69RB	STL69RBP	Red	10
STL69RCB	STL69RCBP	Clear lens, red diodes	10
STL69CRPG	STL69CRPGP	Clear lens, red diodes, .180 male bullets	10
STL69RCBMCV2B	STL69RCBMCV2BP	Clear lens, red diodes, 3-way female plug, A69CB base	10
STL69RRXB	STL69RRXBP	Built-in reflex	10
<b>ACCESSORIES</b>			
A69GB	A69GBP	Gasket	10
A69CB	A69CBP	Chrome base for STL69	10
A69RCB	A69RCBP	Chrome base for STL69RRXB	10
<b>RETAIL</b>			
STL69RS		Light only, clam	6
STL69RK		STL69RB with A69CB, clam	6
STL69RRXCS		STL69RRXB with A69RCB, clam	6

<b>FMVSS</b>	STL69:	S T I
	STL69RRXB:	S2 T2 I6 A
<b>MATERIALS</b>	Polycarbonate lens and housing	
<b>VOLT/AMP</b>	STL69:	.350A Stop, .022 Tail
	STL69RRXB:	.161A Stop, .013A Tail
<b>WT/DIMS</b>	STL69:	.441 lbs. / 15" x 1.375" x .625"
	STL69RRXB:	.445 lbs. / 15" x 1.625" x .625"
<b>WARRANTY</b>	Lifetime LED Warranty	



## STL179 SERIES GloLight® Streamline LED Light



LED COMBINATION  
TAIL LIGHTS & KITS

### PATENTED TECHNOLOGY

- Sonically sealed, waterproof
- Low profile design—only 1-3/8" high x 1" thick
- Surface mount on 16-1/8" centers
- Hard wired with separate ground wire

TAIL LIGHT



STOP/TURN



STL179RB

BULK P/N	POLYPACK P/N	DESCRIPTION	QTY
<b>RED STOP/TURN/TAIL - 28 DIODES</b>			
STL179RB	STL179RBP	Stop/turn/tail light	10
<b>ACCESSORIES</b>			
A79CB	A79CBP	Chrome mounting base	10



A79CB

FMVSS	ST I
MATERIALS	Polycarbonate lens and housing
VOLT/AMP	12.8VDC - .634 Stop/Turn, .445A Tail
WT/DIMS	.353 lbs. / 17" x 1.375" x 1"
WARRANTY	Lifetime LED Warranty

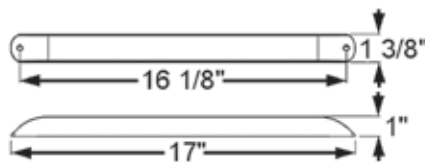

STL179RB

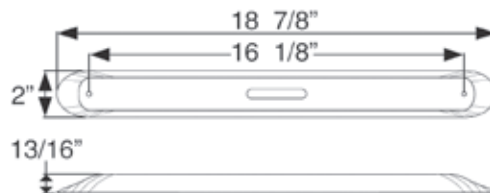

A79CB



## STL79 SERIES Streamline Sealed LED Lights

- Sonically sealed, waterproof
- Low profile design—only 1-3/8" high x 1" thick
- Surface mount on 16-1/8" centers
- Available as stop/turn/tail lights and third brake lights
- Hard wired with separate ground wire



STL79RB/80RB



STL89RCB

BULK P/N	POLYPACK P/N	DESCRIPTION	QTY
<b>RED STOP/TURN/TAIL - 11 DIODES</b>			
STL79RB	STL79RBP	Stop/turn/tail light	10
STL80RB	STL80RBP	Third brake light	10
STL89RCB	STL89RCBP	Clear lens stop/turn/tail light	10
<b>ACCESSORIES</b>			
A79CB	A79CBP	Chrome mounting base	10
<b>RETAIL</b>			
STL79RS		Stop/turn/tail light, clam	6

FMVSS	STL79/89:	S T I
	STL80:	U
MATERIALS	Polycarbonate lens and housing	
VOLT/AMP	STL79/89:	12.8VDC - .350 Stop/Turn, .022A Tail
	STL80:	12.8VDC - .216 Stop
WT/DIMS	.353 lbs. / 17" x 1.375" x 1"	
WARRANTY	Lifetime LED Warranty	

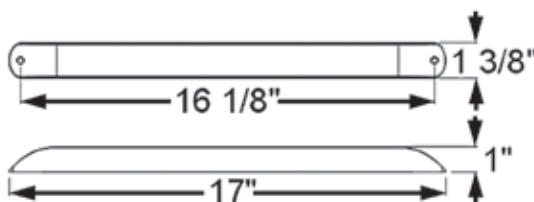

## STL76 SERIES

### Thinline Sealed LED Stop/Turn/Tail Light for Over 80" Wide Applications



LED COMBINATION  
TAIL LIGHTS & KITS

#### PATENTED TECHNOLOGY

- Replaceable, snap-on red lens
- Clear lens sonically sealed to housing making light completely waterproof
- Surface mount on 12-7/8" centers
- Meets SAE S2T2I6 for over 80" wide vehicles
- Hard wired with separate ground wire

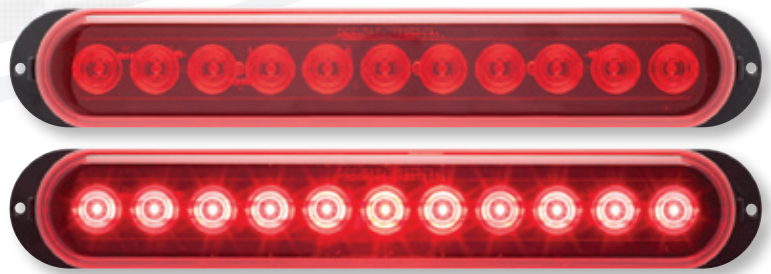

STL76RB

BULK P/N	POLYPACK P/N	DESCRIPTION	QTY
<b>RED STOP/TURN/TAIL LIGHT - 11 DIODES</b>			
STL76RB	STL76RBP	Stop/turn/tail light	10

<b>FMVSS</b>	S2 T2 I6
<b>MATERIALS</b>	Polycarbonate lens and housing
<b>VOLT/AMP</b>	12.8V / .275A Stop, .022A Tail
<b>WT/DIMS</b>	.529 lbs. / 13.26" x 2.13" x 1.42"
<b>WARRANTY</b>	Lifetime LED Warranty

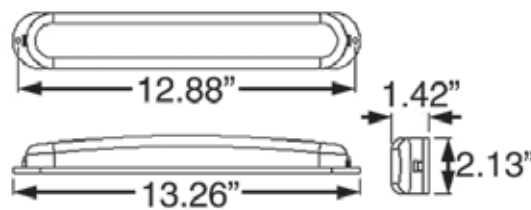



## STL153 SERIES GloLight® LED Dual Face Pedestal Mount Lights

### PATENTED TECHNOLOGY

- 25 LEDs per side
- Ring illuminates for tail light function; inner LEDs light and ring brightens for brake/turn
- Includes built-in 3-LED yellow side marker with reflex
- Hard wired, includes separate ground wire



BULK P/N	POLYPACK P/N	DESCRIPTION	QTY
		<b>DUAL FACE RED YELLOW - 25 DIODES</b>	
STL153ARDBB	STL153ARDBBP	Driver side	10
STL153ARPBB	STL153ARPBBP	Passenger side	10

<b>FMVSS</b>	S2 T2 I6, I6 P, A P2
<b>MATERIALS</b>	Chrome plastic housing, acrylic lens
<b>VOLT/AMP</b>	12.8V / .360A Stop, .030A Tail
<b>WT/DIMS</b>	1.477 lbs. / 4.688" x 4.875" x 2.438"
<b>WARRANTY</b>	Lifetime LED Warranty

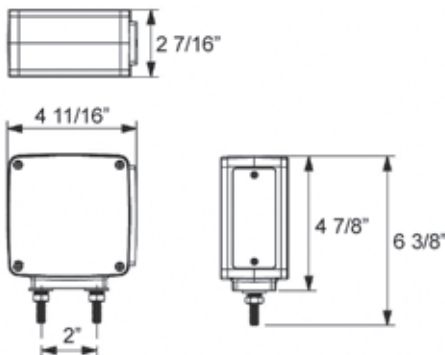

## STL52/53 SERIES LED Pedestal Mount Lights



- Lead wires exit through mounting post; separate ground wire
- 21 LEDs per side
- STL53 available in driver and passenger side models with built-in yellow side marker with reflex



STL52ARB



STL52ARB profile

BULK P/N	POLYPACK P/N	DESCRIPTION	QTY
		<b>DUAL FACE RED YELLOW - 42 DIODES</b>	
STL52ARB	STL52ARBP	Round	10
STL53ARPB	STL53ARPBP	Square, passenger side	10
STL53ARDB	STL53ARDBP	Square, driver side	10

<b>FMVSS</b>	STL52ARB: S T I P
	STL53: Tail S T I P, Side Marker A P2
<b>MATERIALS</b>	STL52: Die cast housing, polycarbonate lens
	STL53: Polycarbonate lens and housing
<b>VOLT/AMP</b>	STL52ARB: 12.8VDC - .360 Stop/Turn, .030A Tail
	STL53: 12.8VDC - .750 Stop/Turn, .114A Tail
<b>WT/DIMS</b>	STL52: 1.477 lbs. / 4.25" x 4.25" x 1.938"
	STL53: .882 lb. / 4.5" x 4.75" x 2.25"
<b>WARRANTY</b>	Lifetime LED Warranty



STL53ARPB

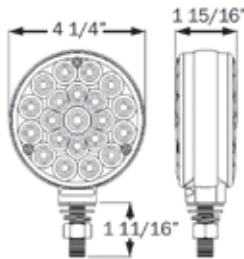

STL52ARB

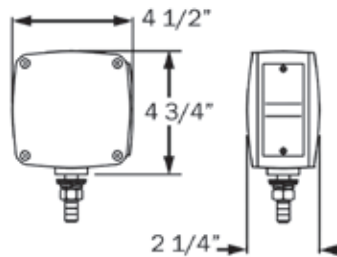

STL53ARDB/ARPB

**GloLight**

## STL190 SERIES GloLight® 7" LED Transit Lights

### PATENTED TECHNOLOGY

- Sonically sealed, waterproof
- Surface mount light with mounting gasket
- Hard wired with separate ground wire

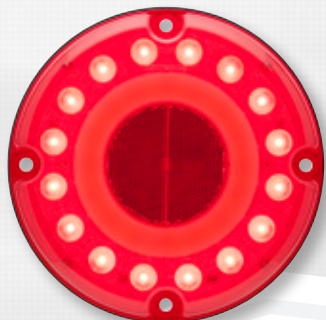

STOP/  
TURN

STL190RB



TAIL  
LIGHT



TURN

STL190AB

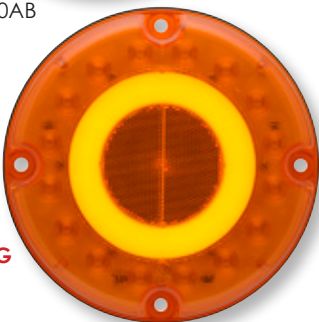

PARKING

BULK P/N	POLYPACK P/N	DESCRIPTION	QTY
<b>RED STOP/TURN/TAIL LIGHT - 32 DIODES</b>			
STL190RB	STL190RBP	Stop/turn/tail light	5
<b>YELLOW PARKING/TURN SIGNAL - 32 DIODES</b>			
STL190AB	STL190ABP	Parking/turn signal	5

<b>FMVSS</b>	Red S2 I6 T2 P2 A; Yellow I6 P2 A
<b>MATERIALS</b>	Polycarbonate lens and housing
<b>VOLT/AMP</b>	Red: 12.8VDC - .340A Stop/Turn, .135A Tail Yellow: 12.8VDC - .410A Turn, .072A Parking
<b>WT/DIMS</b>	.970 lb. / 7" x 7" x 1.625"
<b>WARRANTY</b>	Lifetime LED Warranty

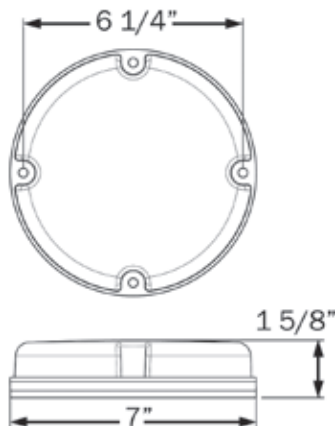

## STL90 SERIES 7" Round LED Transit Lights

- Sonically sealed, waterproof
- Surface mount light with mounting gasket
- Hard wired with separate ground wire
- Available in 12V and 12-24V models



LED COMBINATION  
TAIL LIGHTS & KITS

BULK P/N	POLYPACK P/N	DESCRIPTION	QTY
<b>RED STOP/TURN/TAIL LIGHT - 31 DIODES</b>			
STL90RB	STL90RBP	Stop/turn/tail light, 12V	5
STL90R24B	STL90R24BP	Stop/turn/tail light, 12-24V	5
<b>YELLOW TURN SIGNAL - 31 DIODES</b>			
STL90AB	STL90ABP	Parking/turn signal, 12V	5
STL90A24B	STL90A24BP	Parking/turn signal, 12-24V	5

<b>FMVSS</b>	Red S2 I6 T2 P2 A; Yellow I6 P2 A
<b>MATERIALS</b>	Polycarbonate lens and housing
<b>VOLT/AMP</b>	Red: 12.8VDC - .243A Stop/Turn, .046A Tail Yellow: 12.8VDC - .275A Turn, .042A Parking
<b>WT/DIMS</b>	.970 lb. / 7" x 7" x 1.438"
<b>WARRANTY</b>	Lifetime LED Warranty

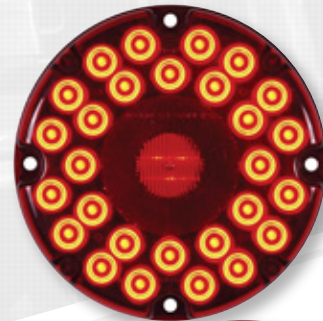
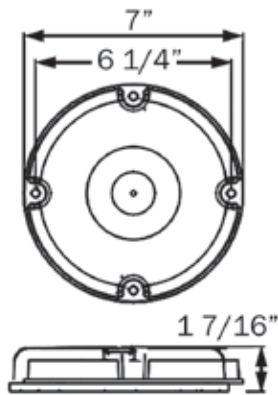

STL90RB

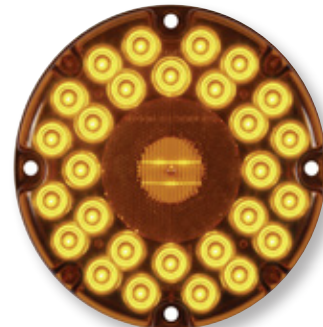
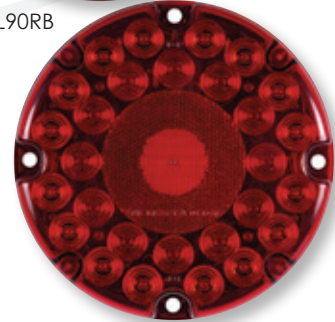

STL90AB

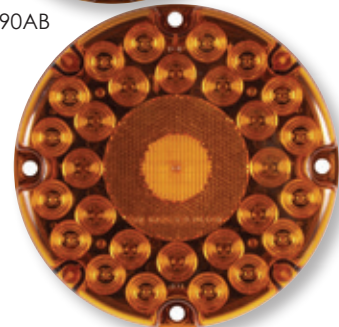



## STL161 SERIES GloLight® LED Combination Tail Lights



TAIL LIGHT

### PATENTED TECHNOLOGY

- Stud mount stop/turn/tail light with built-in back-up light and reflex
- 30-LED tail light; 6-LED back-up light
- Driver side light also includes 3-LED license light
- Hard wired; wire exits through back of housing
- Includes ground wire



STOP/TURN/BACK-UP



STL161RB

BULK P/N	POLYPACK P/N	DESCRIPTION	QTY
<b>GLOLIGHT® COMBINATION TAIL LIGHTS - 36 DIODES</b>			
STL161RB	STL161RBP	Passenger side, 30-LED tail, 6-LED back-up	5
STL161RLB	STL161RLBP	Driver side with 3-LED license light	5

<b>FMVSS</b>	STL161RB: A 16 (2)R S2 (3)T STL161RLB: A 16 (2)R S2 (3)T L
<b>MATERIALS</b>	Acrylic lens, plastic housing
<b>VOLT/AMP</b>	12.8VDC - Tail .19A, Stop/Turn .30A, Back-up .21A
<b>WT/DIMS</b>	.882 lb. / 5.813" x 6.75" x 2.688"
<b>WARRANTY</b>	Lifetime LED Warranty

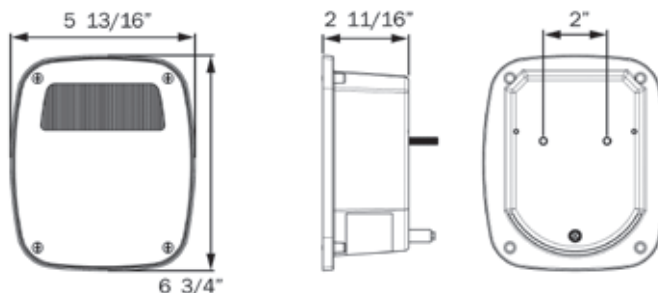



## STL60/61 SERIES LED Combination Tail Lights

- Stud mount stop/turn/tail lights with built-in back-up light and reflex
- Choose from Optronics® LED 52-diode and FLEET Count™ 15-diode tail lights
- Hard wired; wire exits through back of housing
- Includes ground wire



STL60RB

BULK P/N	POLYPACK P/N	DESCRIPTION	QTY
<b>OPTRONICS® COMBINATION TAIL LIGHTS - 52 DIODES</b>			
STL60RB	STL60RBP	Passenger side, 16-LED tail, 36-LED back-up	5
STL60RLB	STL60RLBP	Driver side with 5-LED license light	5
<b>FLEET COUNT™ COMBINATION TAIL LIGHTS - 15 DIODES</b>			
STL61RB	STL61RBP	Passenger side, 9-LED tail, 6-LED back-up	5
STL61RLB	STL61RLBP	Driver side with 3-LED license light	5



STL61RB

<b>FMVSS</b>	STL61RB:	A 16 (2)R S2 (3)T
	STL61RLB:	A 16 (2)R S2 (3)T L
<b>MATERIALS</b>	Acrylic lens, plastic housing	
<b>VOLT/AMP</b>	12.8VDC - Tail .015A, Stop/Turn .308A, Back-up .328A	
<b>WT/DIMS</b>	.882 lb. / 5.813" x 6.75" x 2.688"	
<b>WARRANTY</b>	Lifetime LED Warranty	

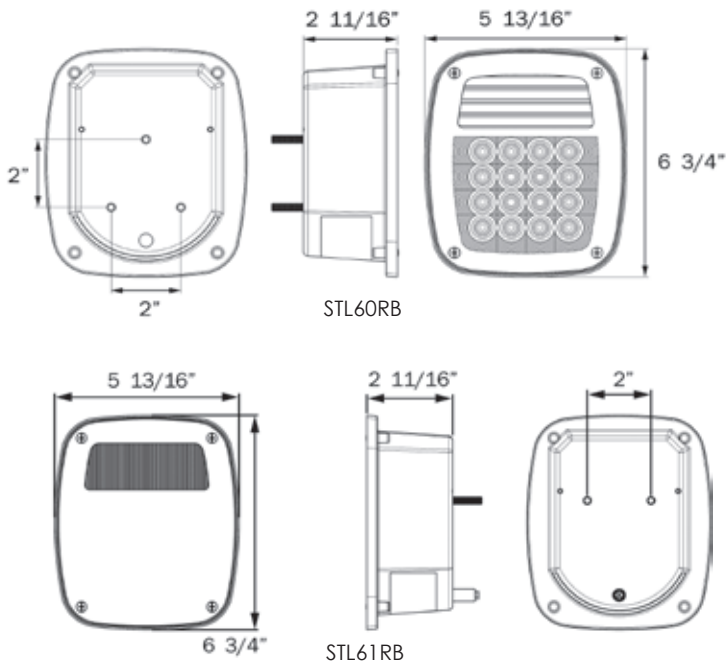

## GloLight®

### STL108/109 SERIES GloLight® LED Combination Tail Lights

#### PATENTED TECHNOLOGY

- Traditional style fits many applications
- Stud mount lights mount on 2" centers
- Hard wired, with separate ground wire



TAIL LIGHT



STOP/TURN

STL108/109RB



TLL190RK

BULK P/N	POLYPACK P/N	DESCRIPTION	QTY
<b>COMBINATION TAIL LIGHTS - 25 DIODES</b>			
STL108RB	STL108RBP	Passenger side	10
STL109RB	STL109RBP	Driver side, 3-LED license light	10
<b>RETAIL</b>			
TLL190RK	Set: STL108RB, STL109RB, mounting hardware; <b>Try Me</b> package, clam		2

<b>FMVSS</b>	Stop/Tail A I S T, Side Marker A P2, License L
<b>MATERIALS</b>	Acrylic lens, ABS housing
<b>VOLT/AMP</b>	12.8VDC - Stop/Turn .310A, Marker .230A
<b>WT/DIMS</b>	.970 lb. / 5.031" x 4.563" x 2.625"
<b>WARRANTY</b>	Lifetime LED Warranty

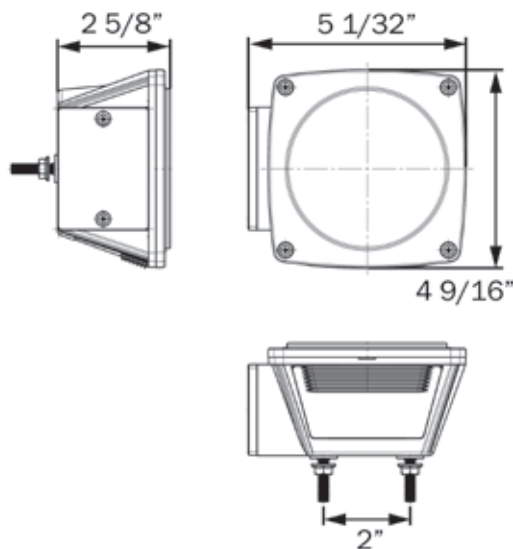

## STL8/9 SERIES LED Combination Tail Lights

- Traditional style fits many applications
- Stud mount lights mount on 2" centers
- Hard wired, with separate ground wire

BULK P/N	POLYPACK P/N	DESCRIPTION	QTY
<b>COMBINATION TAIL LIGHTS - 11 DIODES</b>			
STL8RB	STL8RBP	Passenger side	10
STL8R3B	STL8R3BP	Passenger side, female PL-3 plug	10
STL9RB	STL9RBP	Driver side, 3-LED license light	10
STL9R3B	STL9R3BP	Driver side, 3-LED license light, female PL-3 plug	10
<b>RETAIL</b>			
STL6RS	Passenger side		6
STL7RS	Driver side with 3-LED license light		6
TLL9RK	Kit: STL8RB, STL9RB, 25-ft harness, license plate bracket, mounting hardware; clam		2
TLL90RK	Set: STL8RB, STL9RB, mounting hardware; clam		2

<b>FMVSS</b>	Stop/Tail A I S T, Side Marker A P2, License L
<b>MATERIALS</b>	Acrylic lens and plastic housing
<b>VOLT/AMP</b>	12.8VDC - Stop/Turn .259A, Marker .062A
<b>WT/DIMS</b>	.970 lb. / 5.25" x 4.75" x 2.688"
<b>WARRANTY</b>	Lifetime LED Warranty

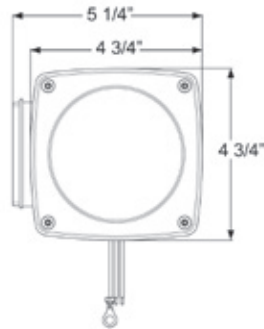

STL8/9RB  
STL6/7RS



TLL9RK



TLL90RK



STL2/3RB

## STL2/3 SERIES

### LED Combination Tail Lights for Over 80" Applications

- Designed for over 80" wide applications
- Stud mount lights mount on 2" centers
- Hard wired, with separate ground wire

BULK P/N	POLYPACK P/N	DESCRIPTION	QTY
<b>OVER 80 COMBINATION TAIL LIGHTS - 18 DIODES</b>			
STL2RB	STL2RBP	Passenger side	10
STL3RB	STL3RBP	Driver side, license light	10

<b>FMVSS</b>	Stop/Tail A(3) I(3) S(3) T, Side Marker A P2, License L
<b>MATERIALS</b>	Acrylic lens and plastic housing
<b>VOLT/AMP</b>	12.8VDC - Stop/Turn .268A, Marker .059A
<b>WT/DIMS</b>	.970 lb. / 6.25" x 4.75" x 2.688"
<b>WARRANTY</b>	Lifetime LED Warranty

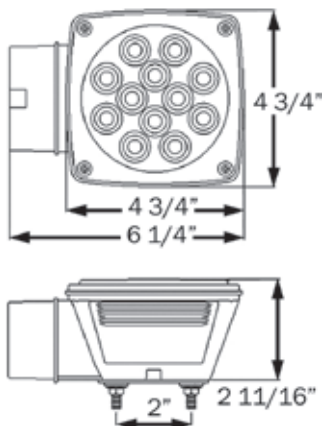

## STL008/009 SERIES ONE™ LED Combination Tail Lights

- Sealed, waterproof design
- Traditional style fits many applications
- Stud mount lights mount on 2" centers
- Hard wired with separate ground wire

**ONE™**  
LED LAMPS



STL008RB



STL009RB

BULK P/N	POLYPACK P/N	DESCRIPTION	QTY
<b>COMBINATION TAIL LIGHTS - 1 DIODE</b>			
STL008RB	STL008RBP	Passenger side	10
STL009RB	STL009RBP	Driver side	10
STL008RPG	STL008RPGP	Passenger side, .180 bullets	10
STL009RPG	STL009RPGP	Driver side, .180 bullets	10
<b>RETAIL</b>			
STL008RS	Passenger side		6
STL009RS	Driver side with 3-LED license light		6
TLL008RK	Set: STL008RB, STL009RB, mounting hardware, clam		2

<b>FMVSS</b>	S T A. P2 A, L
<b>MATERIALS</b>	Acrylic lens and plastic housing
<b>VOLT/AMP</b>	12.8VDC - Stop/Turn .25A, Marker .062A
<b>WT/DIMS</b>	.970 lb. / 5.063" x 4.563" x 2.875"
<b>WARRANTY</b>	Lifetime LED Warranty



TLL008RK

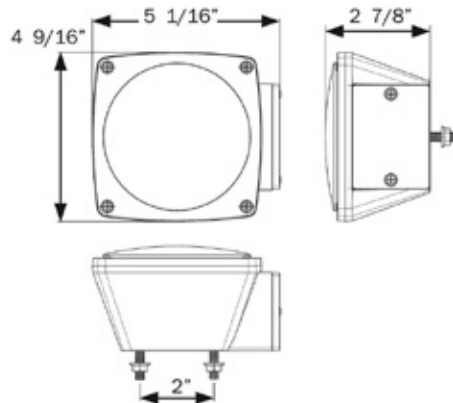



## STL28/29 SERIES Miro-Flex™ LED Combination Tail Lights

- Universal design fits many applications
- Stud mount lights mount on 2" centers
- Hard wired with separate ground wire
- STL28 is 6-function: stop, turn, tail, rear reflex, side marker and side reflex
- STL29 is 7-function: above plus license illuminator



STL29RB



STL28RB



TLL29RK

BULK P/N	POLYPACK P/N	DESCRIPTION	QTY
<b>COMBINATION TAIL LIGHTS - 15 DIODES</b>			
STL28RB	STL28RBP	Passenger side	10
STL29RB	STL29RBP	Driver side, with 5-LED license light	10
<b>RETAIL</b>			
<b>Retail Ready</b>			
TLL28RK	Set: STL28RB, STL29RB, mounting hardware; clam		2
TLL29RK	Kit: STL28RB, STL29RB, 25-ft harness, license plate bracket, mounting hardware; clam		2

<b>FMVSS</b>	STL28:	Stop/Tail A I S T, Side Marker A P2
	STL29:	Stop/Tail A I S T, Side Marker A P2, License L
<b>MATERIALS</b>	Acrylic lens and plastic housing	
<b>VOLT/AMP</b>	STL28:	12.8VDC - .174A Stop/Turn, .054A Marker
	STL29:	12.8VDC - .174A Stop/Turn, .054A Marker
<b>WT/DIMS</b>	.750 lb. / 5.25" x 5" x 2.625"	
<b>WARRANTY</b>	Lifetime LED Warranty	

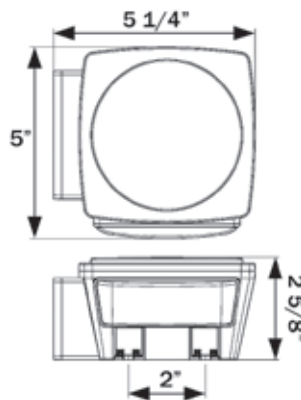

## STL116/117 SERIES GloLight® LED Low Profile Combination Tail Lights

- Designed for marine trailer application
- Sealed, waterproof construction
- Universal mount
- Hard wired, with separate ground wire

PATENTED  
TECHNOLOGY

**GloLight®**



TAIL LIGHT

STL116RB



STOP/TURN

STL117RB



TLL170RK

BULK P/N	POLYPACK P/N	DESCRIPTION	QTY
<b>COMBINATION TAIL LIGHTS - 28 DIODES</b>			
STL116RB	STL116RBP	Passenger side	10
STL117RB	STL117RBP	Driver side, with 6-LED license light	10
<b>RETAIL</b>			
TLL170RK	Set: STL116RB, STL117RB, mounting hardware, <b>Try Me</b> package		2

<b>FMVSS</b>	STL116: A I S T, P2 A ; STL117: A I S T, P2 A, L
<b>MATERIALS</b>	Acrylic lens and plastic housing
<b>VOLT/AMP</b>	12.8VDC - Stop/Turn .252A, Marker .135A
<b>WT/DIMS</b>	.816 lb. / 8" x 2.9" x 2.6"
<b>WARRANTY</b>	Lifetime LED Warranty

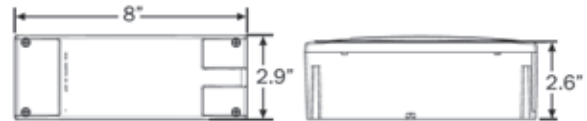

## STL14/15 SERIES FLEET Count™ LED Low Profile Combination Tail Lights

- Designed for marine trailer application
- Sealed, waterproof construction
- Universal mount
- Hard wired, with separate ground wire

**FLEET COUNT**

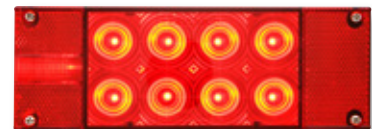

STL14/15RB

BULK P/N	POLYPACK P/N	DESCRIPTION	QTY
<b>COMBINATION TAIL LIGHTS - 12 DIODES</b>			
STL14RB	STL14RBP	Passenger side	10
STL15RB	STL15RBP	Driver side, with 6-LED license light	10

<b>FMVSS</b>	STL14: A I S T, P2 A ; STL15: A I S T, P2 A, L
<b>MATERIALS</b>	Acrylic lens and plastic housing
<b>VOLT/AMP</b>	12.8VDC - Stop/Turn .252A. Marker .135A
<b>WT/DIMS</b>	.816 lb. / 8" x 2.875" x 2.813"
<b>WARRANTY</b>	Lifetime LED Warranty

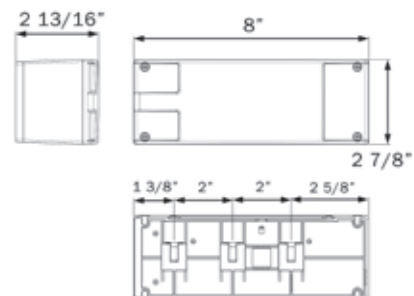

LED COMBINATION  
TAIL LIGHTS & KITS



## STL16/17 SERIES LED Combination Tail Lights

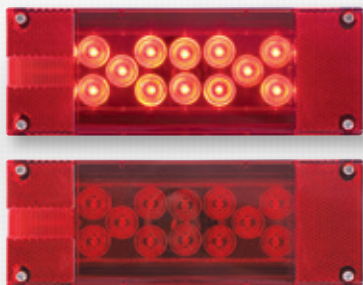

STL17RB

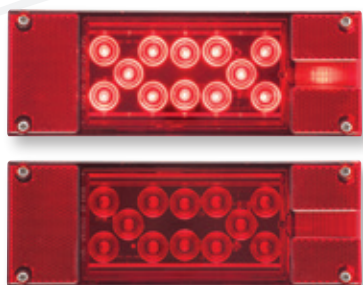

STL16NTRB



TLL16RK



- Designed for marine trailer application
- Sealed, waterproof construction
- Universal mount
- Hard wired, with separate ground wire
- STL16/17NTRB feature light tube technology and SMD LED

BULK P/N	POLYPACK P/N	DESCRIPTION	QTY
<b>COMBINATION TAIL LIGHTS - 18 DIODES</b>			
STL16RB	STL16RBP	Passenger side	10
STL17RB	STL17RBP	Driver side, with 4-LED license light	10
STL16NTRB	STL16NTRB	Passenger side, SMD LED	10
STL17NTRB	STL17NTRB	Driver side, SMD LED with 4-LED license light	10
<b>ACCESSORIES</b>			
AL16RB	AL16RBP	Tail light lens	50
AL17RB	AL17RBP	Side marker lens	50
<b>RETAIL</b>			
STL16RS	Passenger side, stainless hardware		6
STL17RS	Driver side with 4-LED license light, stainless hardware		6
TLL160RK	Set: STL16RB, STL17RB, mounting hardware; clam		2
TLL16RK	Kit: STL16RB, STL17RB, 25-ft harness, license plate bracket, stainless steel mounting hardware; clam		2

<b>FMVSS</b>	STL16: Stop/Tail A I S T P2 PC, Side Marker A P2 STL17: Stop/Tail A I S T P2 PC, Side Marker A P2, License L
<b>MATERIALS</b>	Acrylic lens and plastic housing
<b>VOLT/AMP</b>	STL16: 12.8VDC - .259A Stop/Turn, .062A Marker STL17: 12.8VDC - .268A Stop/Turn, .059A Marker
<b>WT/DIMS</b>	.816 lb. / 8.063" x 2.875" x 2.813"
<b>WARRANTY</b>	Lifetime LED Warranty

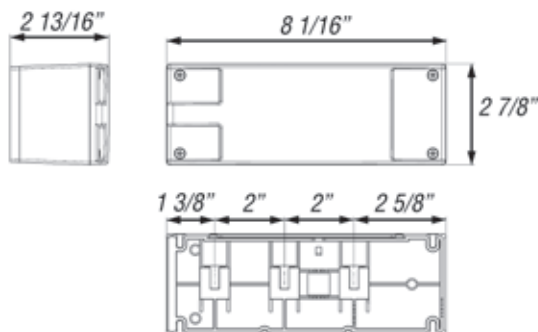



## STL0016/0017 SERIES ONE™ LED Combination Tail Lights



- Designed for marine trailer application
- Sealed, waterproof construction
- Universal mount
- Hard wired, with separate ground wire



STL0016RB



STL0017RB

BULK P/N	POLYPACK P/N	DESCRIPTION	QTY
<b>COMBINATION TAIL LIGHTS</b>			
STL0016RB	STL0016RBP	Passenger side	10
STL0017RB	STL0017RBP	Driver side, with license light	10
<b>RETAIL</b>			
STL0016RS	Passenger side, clam		6
STL0017RS	Driver side with 4-LED license light, clam		6
TLL0016RK	Set: STL0016RB, STL0017RB, mounting hardware, clam		2

<b>FMVSS</b>	STL0016: Stop/Tail A I S T P2, Side Marker A P2 STL0017: Stop/Tail A I S T P2, Side Marker A P2, License L
<b>MATERIALS</b>	Acrylic lens and plastic housing
<b>VOLT/AMP</b>	STL0016: 12.8VDC - .31A Stop/Turn, .12A Marker STL0017: 12.8VDC - .32A Stop/Turn, .26A Marker
<b>WT/DIMS</b>	.816 lb. / 8.0" x 2.9" x 2.6"
<b>WARRANTY</b>	Lifetime LED Warranty

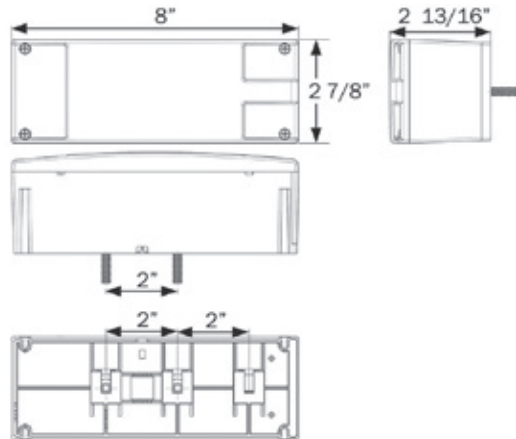

TLL0016RK

LED COMBINATION TAIL LIGHTS & KITS



## STL26/27 SERIES Miro-Flex™ LED Combination Tail Lights

- Designed for marine trailer application
- Sealed, waterproof construction
- Universal mount
- Hard wired, with separate ground wire



STL26RB

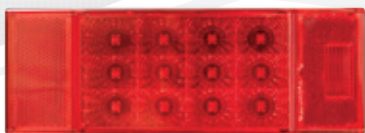

STL27RB



BULK P/N	POLYPACK P/N	DESCRIPTION	QTY
<b>COMBINATION TAIL LIGHTS - 14 DIODES</b>			
STL26RB	STL26RBP	Passenger side	10
STL27RB	STL27RBP	Driver side with 4-LED license light	10
<b>RETAIL</b>			
TLL26RK	Set: STL26RB, STL27RB, mounting hardware; clam		2



<b>FMVSS</b>	STL26: A 16 S2 (3)T PC STL27: A 16 S2 (3)T PC L
<b>MATERIALS</b>	Acrylic lens and plastic housing
<b>VOLT/AMP</b>	STL26: 12.8VDC - .167A Stop/Turn, .054A Marker STL27: 12.8VDC - .167A Stop/Turn, .107A Marker/License
<b>WT/DIMS</b>	.882 lb. / 8.063" x 2.938" x 2.688"
<b>WARRANTY</b>	Lifetime LED Warranty



TLL26RK

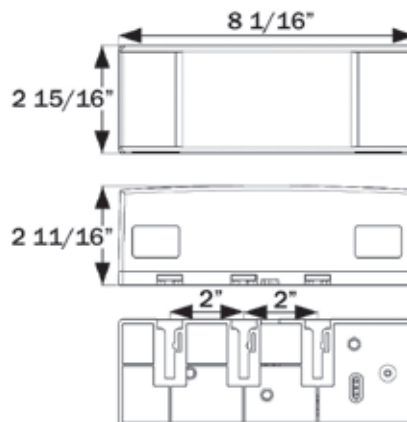

## STL36/37 SERIES LED Combination Tail Lights

- Designed for marine trailer application
- Sealed, waterproof construction
- Universal mount
- Hard wired, with separate ground wire

BULK P/N	POLYPACK P/N	DESCRIPTION	QTY
<b>COMBINATION TAIL LIGHTS - 17 DIODES</b>			
STL36RB	STL36RBP	Passenger side	20
STL36RPG	STL36RPGP	Passenger side, dual plug and ground eyelet	20
STL37RB	STL37RBP	Driver side, 6-LED license light	20
STL37RPG	STL37RPGP	Driver side, 6-LED license light, dual plug and ground eyelet	20
<b>RETAIL</b>			
STL36RS	Passenger side		6
STL37RS	Driver side with 4-LED license light		6
TLL36RK	Kit: STL36RB, STL37RB, (2) MCL91AK sealed yellow marker lights with chrome bases, 25-ft harness, license plate bracket, stainless steel mounting hardware; clam		2

<b>FMVSS</b>	STL36: Stop/Tail A S T I P2, Side Marker A PC STL37: Stop/Tail A S T I P2, Side Marker A PC, License L
<b>MATERIALS</b>	Acrylic lens and plastic housing
<b>VOLT/AMP</b>	12.8VDC - .181A Stop/Turn, .047A Marker
<b>WT/DIMS</b>	.992 lb. / 7.875" x 3.25" x 2.875"
<b>WARRANTY</b>	Lifetime LED Warranty



STL36/37RB



TLL36RK

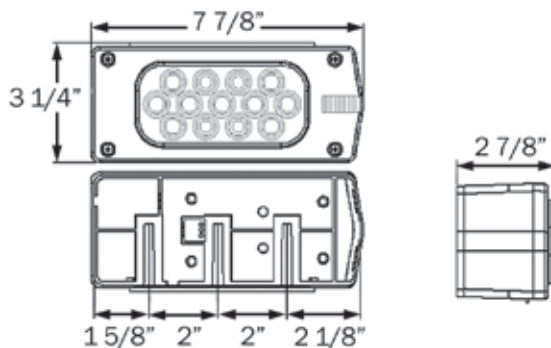



## STL56/57 SERIES LED Combination Tail Lights



STL56/57RB

- Designed for marine trailer application
- Sealed, waterproof construction
- Universal mount
- Hard wired, with separate ground wire
- Stainless steel hardware

BULK P/N	POLYPACK P/N	DESCRIPTION	QTY
<b>COMBINATION TAIL LIGHTS - 18 DIODES</b>			
STL56RB	STL56RBP	Passenger side	10
STL57RB	STL57RBP	Driver side, 5-LED license light	10
<b>RETAIL</b>			
TLL56RK	Kit: STL56RB, STL57RB, 25-ft harness, license plate bracket, stainless steel mounting hardware; clam		2



TLL56RK

<b>FMVSS</b>	STL56: Stop/Tail A S T I P2, Side Marker A P2
	STL57: Stop/Tail A S T I P2, Side Marker A P2, License L
<b>MATERIALS</b>	Acrylic lens and plastic housing
<b>VOLT/AMP</b>	STL56: 12.8VDC - .259A Stop/Turn, .062A Marker
	STL57: 12.8VDC - .268A Stop/Turn, .059A Marker
<b>WT/DIMS</b>	.816 lb. / 6.063" x 3.625" x 2.25"
<b>WARRANTY</b>	Lifetime LED Warranty

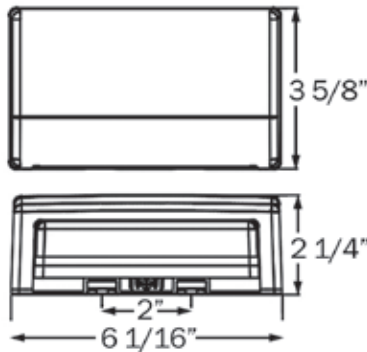

## RBL10AS LED Strobe/Beacon Light

- Magnetic mount
- 12-ft. coil cord with power plug

BULK P/N	POLYPACK P/N	DESCRIPTION	QTY
<b>RETAIL</b>			
RBL10AS		Amber rotary beacon 12/24V, clam 	2

<b>VOLTAGE</b>	10-30VDC
<b>WT/DIMS</b>	.88 lb. / 5.125" x 5.125" x 3.5"
<b>WARRANTY</b>	Lifetime LED Warranty



RBL10AS

## RBL10CA LED Multi-Function Strobe/Beacon Light

- Sonically sealed
- Five flash patterns
- Surface mount
- Operating range 9-36VDC
- SAE J845/EMC R10 approved

BULK P/N	POLYPACK P/N	DESCRIPTION	QTY
<b>YELLOW</b>			
RBL10CA	-	Clear lens, amber rotary beacon	1

<b>FMVSS</b>	W3-1
<b>MATERIALS</b>	Polycarbonate
<b>VOLT/AMP</b>	12.8VDC - 1.04A, 36.0VDC - 0.36A
<b>WT/DIMS</b>	1.53 lb. / 6.377" x 6.377" x 4.173"
<b>WARRANTY</b>	Lifetime LED Warranty



RBL10CA

## TLL21/31 SERIES LED Magnet Mount Towing Light Kits

Sonically sealed, waterproof

BULK P/N	POLYPACK P/N	DESCRIPTION	QTY
<b>RETAIL</b>			
TLL21RK		Towing light kit with wiring harness, clam 	2
TLL31RK		Wireless magnet mount towing light kit, clam	2

<b>FMVSS</b>	S T I
<b>MATERIALS</b>	Polycarbonate
<b>VOLT/AMP</b>	12.8VDC - .360A Stop/Turn, .030A Tail
<b>WT/DIMS</b>	2 lbs. / 3.875" x 2.188" x 6"
<b>WARRANTY</b>	Lifetime LED Warranty

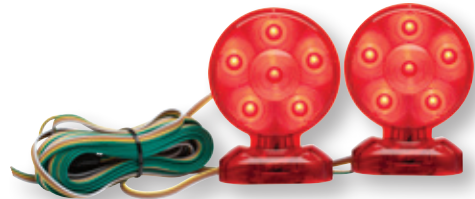

TLL21RK



## BUL101 SERIES GloLight® 4" Round Sealed DOT LED Back-Up Lights

### PATENTED TECHNOLOGY

- Sonically sealed, waterproof
- Certified for back-up light function when installed as pair in two-lamp system [SAE (2)R]



BUL101CB

BULK P/N	POLYPACK P/N	DESCRIPTION	QTY
<b>CLEAR BACK-UP LIGHTS - 21 DIODES</b>			
BUL101CB	BUL101CBP	Standard 2-pin connection	10
BUL101CKB	BUL101CKBP	Kit with A45GB and A49PB	10
<b>ACCESSORIES</b>			
A45GB	A45GBP	Grommet	50
A45CB	A45CBP	Pigtail, 2-wire	100
A49PB	A49PBP	Right angle pigtail, 2-wire	100
BK45BB	BK45BBP	Black steel bracket	10
A45BB	A45BBP	Black plastic flange	100
A45SB	A45SBP	Stainless steel mounting flange	20
A45CGB	A45CGBP	Chrome grommet cover	20

<b>FMVSS</b>	(2) R
<b>MATERIALS</b>	Polycarbonate lens and housing
<b>VOLT/AMP</b>	12.8VDC - 0.425A
<b>WT/DIMS</b>	.309 lbs. / 4.313" x 4.313" x 1.625"
<b>WARRANTY</b>	Lifetime LED Warranty

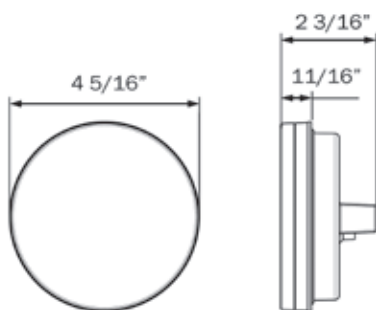

HOLE CUT-OUT: 4.5"

## BUL06 SERIES

### FLEET Count™ 4" Round Sealed DOT LED Back-Up Lights

- Sonically sealed, waterproof
- Certified for back-up light function when installed as pair in two-lamp system [SAE (2)R]



LED DOT COMPLIANT  
BACK-UP LIGHTS

BULK P/N	POLYPACK P/N	DESCRIPTION	QTY
<b>CLEAR BACK-UP LIGHTS - 6 DIODES</b>			
BUL06CB	BUL06CBP	Grommet mount, 2-pin connection	10
BUL06CKB	BUL06CKBP	Kit with A45GB and A49PB, 2-pin	10
BUL06CMB	BUL06CMBP	Grommet mount, weathertight connection	10
BUL06CFB	BUL06CFBP	Flange mount, 2-pin connection	10
BUL06CFMB	BUL06CFMBP	Flange mount, weathertight connection	10

<b>ACCESSORIES</b>			
A45GB	A45GBP	Grommet	50
A45CB	A45CBP	Pigtail, 2-wire	100
A49PB	A49PBP	Right angle pigtail, 2-wire	100
BK45BB	BK45BBP	Black steel bracket	10
A45BB	A45BBP	Black plastic flange	100
A45SB	A45SBP	Stainless steel mounting flange	20
A45CGB	A45CGBP	Chrome grommet cover	20

<b>FMVSS</b>	(2) R
<b>MATERIALS</b>	Polycarbonate lens and housing
<b>VOLT/AMP</b>	12.8VDC - 0.180A
<b>WT/DIMS</b>	Grommet mount: .309 lbs. / 4.25" x 4.25" x 1.625" Flange mount: .350 lbs. / 5.5" x 5.5" x 1.875"
<b>WARRANTY</b>	Lifetime LED Warranty



BUL06CB



BUL06CFB

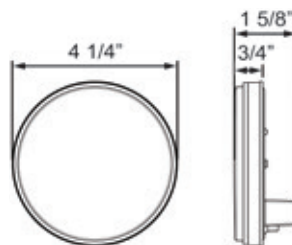

BUL06CB

HOLE CUT-OUT: 4.528"

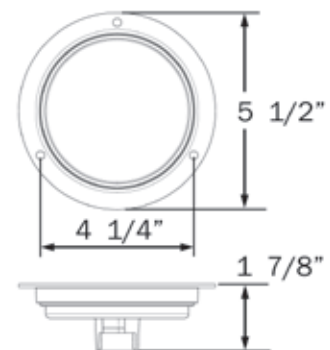

BUL06CFB

HOLE CUT-OUT: 4.579"



## BUL003 SERIES ONE™ 4" Round Sealed DOT LED Back-Up Lights

- Sonically sealed, waterproof
- Certified for back-up light function when installed as pair in two-lamp system [SAE (2)R]



BUL003CB

BULK P/N	POLYPACK P/N	DESCRIPTION	QTY
<b>CLEAR BACK-UP LIGHTS - 1 DIODE</b>			
BUL003CB	BUL003CBP	Grommet mount, 2-pin connection	10
BUL003CKB	BUL003CKBP	Kit with A45GB grommet and A45CB pigtail	10
<b>ACCESSORIES</b>			
A45GB	A45GBP	Grommet	50
A45CB	A45CBP	Pigtail, 2-wire	100
A45PMB	A45PMBP	Weathertight pigtail	100
A49PB	A49PBP	Right angle pigtail, 2-wire	100

<b>FMVSS</b>	(2) R
<b>MATERIALS</b>	Polycarbonate lens and housing
<b>VOLT/AMP</b>	12.8VDC - .030A
<b>WT/DIMS</b>	.22 lbs. / 4.313" x 4.313" x 2"
<b>WARRANTY</b>	Lifetime LED Warranty

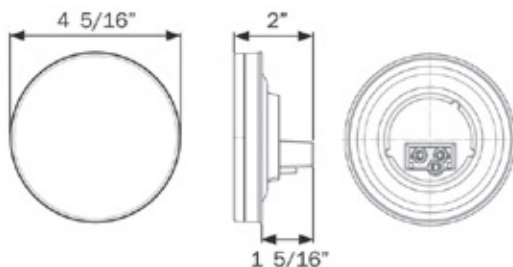



## BUL11 SERIES 4" Round Sealed Clear DOT LED Back-Up Lights

- Sonically sealed, waterproof
- Certified for back-up light function when installed as pair in two-lamp system [SAE (2)R]
- Available in grommet and flange mount models
- Grommet mount version available with standard 2-pin, or optional weathertight connection
- Grommet mount version available in 12V and 24V



LED DOT COMPLIANT  
BACK-UP LIGHTS



BUL11CB



BULK P/N	POLYPACK P/N	DESCRIPTION	QTY
<b>CLEAR BACK-UP LIGHTS - 10 DIODES</b>			
BUL11CB	BUL11CBP	12V, two-pin connection	10
BUL11CKB	BUL11CKBP	12V kit: BUL11CB, A45GB & A49PB	10
BUL11CMB	BUL11CMBP	12V, weathertight connection	10
BUL11CM24B	BUL11CM24BP	24V, weathertight connection	10
<b>CLEAR BACK-UP LIGHT WITH REFLEX - 10 DIODES</b>			
BUL11CBX	BUL11CBXP	12V, two-pin connection	10
<b>ACCESSORIES</b>			
A45GB	A45GBP	Grommet	50
A45CB	A45CBP	Pigtail, 2-wire	100
A49PB	A49PBP	Right angle pigtail, 2-wire	100

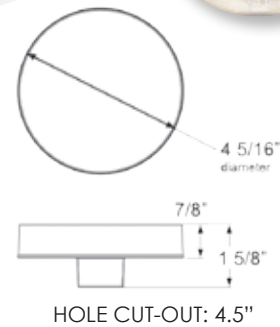

BUL11CBX



<b>FMVSS</b>	(2) R
<b>MATERIALS</b>	Polycarbonate lens and housing
<b>VOLT/AMP</b>	12.8VDC - 0.26A
<b>WT/DIMS</b>	BUL11CB/CKB: .309 lbs. / 4.313" x 4.313" x 1.625"
	BUL11CMB/CM24B: .309 lbs. / 4.313" x 4.313" x 1.625"
	BUL11CBX: .353 lbs. / 5.75" x 5.75" x 1.625"
<b>WARRANTY</b>	Lifetime LED Warranty

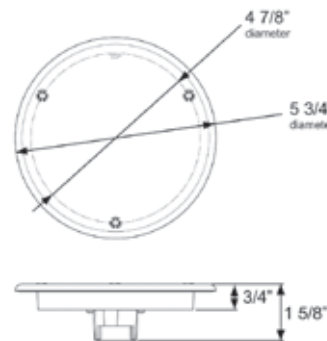

HOLE CUT-OUT: 4.5"



## BUL23/53 SERIES 4" Round Sealed Clear DOT LED Back-Up Lights



- Sonically sealed, waterproof
- Certified for back-up light function when installed as pair in two-lamp system [SAE (2)R]
- High diode count; choose from 27- or 36-LED models
- 27-LED version available in 12V and 24V

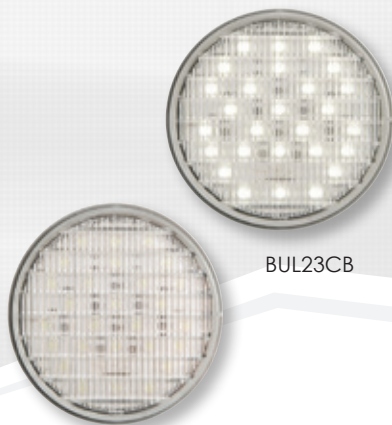

BUL23CB



BUL53CB

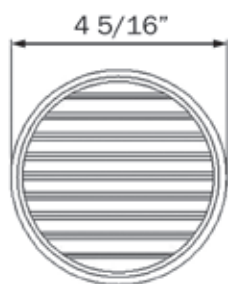

HOLE CUT-OUT: 4.5"

BULK P/N	POLYPACK P/N	DESCRIPTION	QTY
----------	--------------	-------------	-----

### CLEAR BACK-UP LIGHTS - 27 DIODES

BUL23CB	BUL23CBP	12V, two-pin connection	10
BUL23C24B	BUL23C24BP	24V, two-pin connection	10

### CLEAR BACK-UP LIGHT - 36 DIODES

BUL53CB	BUL53CBP	12V, two-pin connection	10
BUL53CKB	BUL53CKBP	12V Kit: BUL53CB, A45GB & A49PB	10

### ACCESSORIES

A45GB	A45GBP	Grommet	50
A45CB	A45CBP	Pigtail, 2-wire	100
A49PB	A49PBP	Right angle pigtail, 2-wire	100

FMVSS	(2) R
MATERIALS	Polycarbonate lens and housing
VOLT/AMP	BUL23: 12.8VDC - 0.145A BUL53: 12.8VDC - 0.275A
WT/DIMS	.309 lbs. / 4.313" x 4.313" x 2"
WARRANTY	Lifetime LED Warranty

## BUL111 SERIES GloLight® 6" Oval Sealed DOT LED Back-Up Lights

**GloLight®**

### PATENTED TECHNOLOGY

- Sonically sealed, waterproof
- Certified for back-up light function when installed as pair in two-lamp system [SAE (2)R]



BUL111CB

BULK P/N	POLYPACK P/N	DESCRIPTION	QTY
<b>CLEAR BACK-UP LIGHTS - 22 DIODES</b>			
BUL111CB	BUL111CBP	Standard two-pin connection	10
<b>ACCESSORIES</b>			
A70GB	A70GBP	Grommet	50
A45CB	A45CBP	Pigtail, 2-wire	100
A49PB	A49PBP	Right angle pigtail, 2-wire	100

<b>FMVSS</b>	(2) R
<b>MATERIALS</b>	Polycarbonate lens and housing
<b>VOLT/AMP</b>	12.8VDC - 0.386A
<b>WT/DIMS</b>	.265 lbs. / 6.5" x 2.375" x 1.75"
<b>WARRANTY</b>	Lifetime LED Warranty

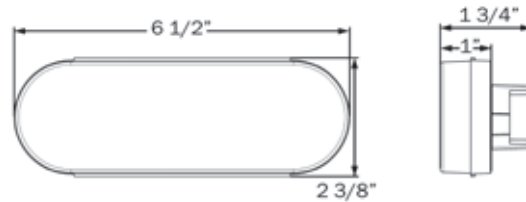

HOLE CUT-OUT: 6.85" x 2.52" (1.26" R)

LED DOT COMPLIANT  
BACK-UP LIGHTS



## BUL12 SERIES FLEET Count™ 6" Oval Sealed DOT LED Back-Up Lights



BUL12CB



BUL12CFB

- Sonically sealed, waterproof
- Available with standard or weathertight connection
- Flange mount models available for recess or surface mount installation
- Certified for back-up light function when installed as pair in two-lamp system [SAE (2)R]

BULK P/N	POLYPACK P/N	DESCRIPTION	QTY
<b>CLEAR BACK-UP LIGHTS - 6 DIODES</b>			
BUL12CB	BUL12CBP	Recess mount, 2-pin	10
BUL12CFB	BUL12CFBP	Recess flange mount, 2-pin	10
BUL12CKB	BUL12CKBP	Kit with A70GB and A45CB, 2-pin	10
BUL12CSB	BUL12CSBP	Surface flange mount, hard wired	10
<b>ACCESSORIES</b>			
A70GB	A70GBP	Grommet	50
A45CB	A45CBP	Pigtail, 2-wire	100
A49PB	A49PBP	Right angle pigtail, 2-wire	100
A78CB1	A78CB1P	Chrome trim ring, snap-on	25

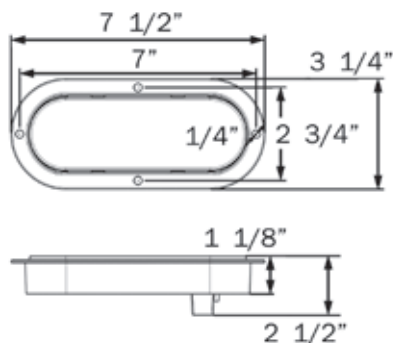

BUL12CFB

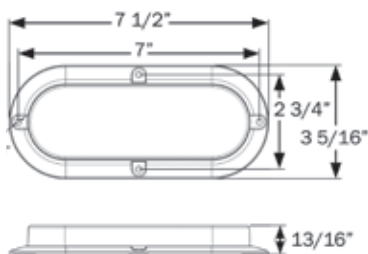

BUL12CSB

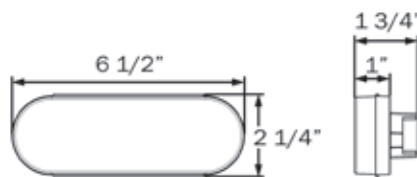

BUL12CB

FMVSS	(2) R
MATERIALS	Polycarbonate lens and housing
VOLT/AMP	12.8VDC - 0.260A
WT/DIMS	.265 lbs. / 6.5" x 2.25" x 1.75"
WARRANTY	Lifetime LED Warranty

## BUL002 SERIES

### ONE™ 6" Oval Sealed DOT LED Back-Up Lights

**ONE™**  
LED LAMPS

- Sonically sealed, waterproof
- Certified for back-up light function when installed as pair in two-lamp system [SAE (2)R]

BULK P/N	POLYPACK P/N	DESCRIPTION	QTY
<b>CLEAR BACK-UP LIGHTS - 1 DIODE</b>			
BUL002CB	BUL002CBP	Standard two-pin connection	10
BUL002CM3B	BUL002CM3BP	Weathertight connection	10
<b>ACCESSORIES</b>			
A70GB	A70GBP	Grommet	50
A45CB	A45CBP	Pigtail, 2-wire	100
A49PB	A49PBP	Right angle pigtail, 2-wire	100
A45PMB	A45PMBP	Pigtail, weathertight	50



BUL002CB

<b>FMVSS</b>	(2) R
<b>MATERIALS</b>	Polycarbonate lens and housing
<b>VOLT/AMP</b>	12.8VDC - 0.30A
<b>WT/DIMS</b>	.265 lbs. / 6.5" x 2.375" x 1.75"
<b>WARRANTY</b>	Lifetime LED Warranty

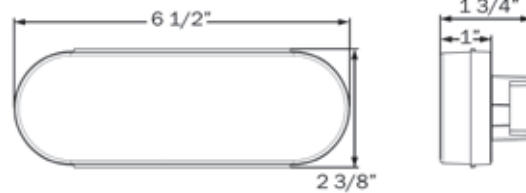

HOLE CUT-OUT: 6.85" x 2.52" (1.26" R)

LED DOT COMPLIANT  
BACK-UP LIGHTS



## BUL10/22/52 SERIES 6" Oval Sealed Clear DOT LED Back-Up Lights



BUL10CB

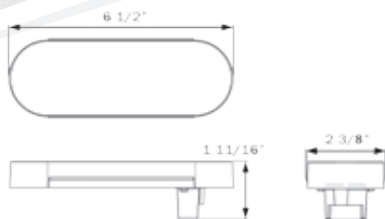

HOLE CUT-OUT: 6.85" x 2.5" (1.25" R)



BUL22CB



BUL52CB

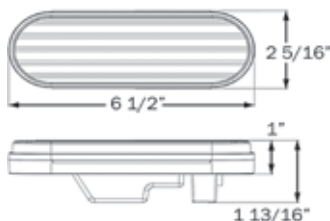

HOLE CUT-OUT: 6.85" x 2.5" (1.25" R)

- Sonically sealed, waterproof
- Certified for back-up light function when installed as pair in two-lamp system [SAE (2)R]
- Low to high diode count; choose from 10-, 27- or 36-LED models
- Accept standard two-pin plugs; BUL10 available with standard or weathertight connection

BULK P/N	POLYPACK P/N	DESCRIPTION	QTY
<b>CLEAR BACK-UP LIGHTS - 10 DIODES</b>			
BUL10CB	BUL10CBP	Standard two-pin connection	10
BUL10CMB	BUL10CMBP	Weathertight connection	10
<b>CLEAR BACK-UP LIGHT - 27 DIODES</b>			
BUL22CB	BUL22CBP	Standard two-pin connection	10
<b>CLEAR BACK-UP LIGHT - 36 DIODES</b>			
BUL52CB	BUL52CBP	Standard two-pin connection	10
<b>ACCESSORIES</b>			
A70GB	A70GBP	Grommet	50
A45CB	A45CBP	Pigtail, 2-wire	100
A49PB	A49PBP	Right angle pigtail, 2-wire	100
A45PMB	A45PMBP	Pigtail, weathertight	50
<b>FMVSS</b>	(2) R		
<b>MATERIALS</b>	Polycarbonate lens and housing		
<b>VOLT/AMP</b>	BUL10:	12.8VDC - 0.260A	
	BUL22:	12.8VDC - 0.125A	
	BUL52:	12.8VDC - 0.275A	
<b>WT/DIMS</b>	BUL10:	.265 lbs. / 6.438" x 2.25" x 1.75"	
	BUL22/52:	.397 lbs. / 6.5" x 2.313" x 1.813"	
<b>WARRANTY</b>	Lifetime LED Warranty		

## BUL35/90 SERIES Sealed Clear DOT LED Back-Up Lights

- Sonically sealed, waterproof
- Certified for back-up light function when installed as pair in two-lamp system [SAE (2)R]
- BUL35 is 5.5" x 3.5" recess mount model that accepts standard two-pin plugs
- BUL90 is 7" surface mount model, hard wired, with separate ground wire; designed for transit vehicles



LED DOT COMPLIANT  
BACK-UP LIGHTS



BUL35CB

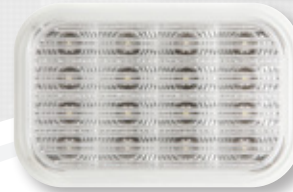

BULK P/N	POLYPACK P/N	DESCRIPTION	QTY
<b>CLEAR 5.5" x 3.5" BACK-UP LIGHT - 16 DIODES</b>			
BUL35CB	BUL35CBP	Standard two-pin connection, 12V	10
<b>CLEAR 7" BACK-UP LIGHT - 42 DIODES</b>			
BUL90CB	BUL90CBP	12V, hard wired	5
BUL90C24B	BUL90C24BP	24V, hard wired	5
<b>ACCESSORIES</b>			
A33GB	A33GBP	Grommet for BUL35CB	50
A45CB	A45CBP	Pigtail, 2-wire	100
A49PB	A49BPB	Right angle pigtail, 2-wire	100

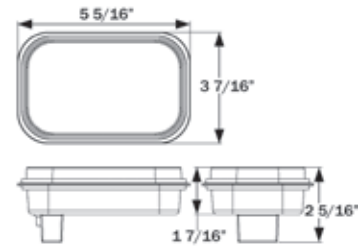

HOLE CUT-OUT: 5.462" x 3.562" (1" R)

<b>FMVSS</b>	(2) R
<b>MATERIALS</b>	Polycarbonate lens and housing
<b>VOLT/AMP</b>	BUL35: 12.8VDC - 0.295A BUL90: 12.8VDC - 0.301A BUL90: 24.0VDC - 0.089A
<b>WT/DIMS</b>	BUL35: .397 lbs. / 5.313" x 3.438" x 2.313" BUL90: .970 lbs. / 7" x 7" x 1.438"
<b>WARRANTY</b>	Lifetime LED Warranty

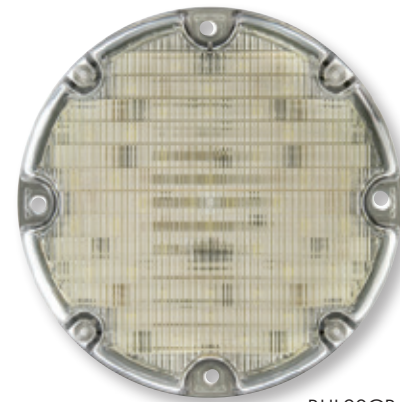

BUL90CB

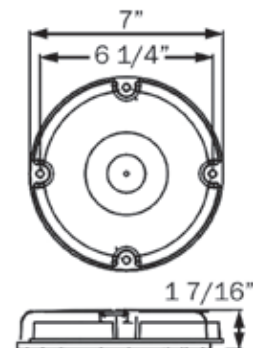



## SLL43 SERIES 4" Round Sealed LED Warning Lamps



SLL43AB1  
SLL43AB2

- Sonically sealed, waterproof
- Flashing lights with triple-flash function, meeting SAE J595 and J845 standards for Class 2 and Class 3 directional warning lamps
- Use two Function 1 or Function 2 lights for synchronous flashing or pair a Function 1 with a Function 2 light for alternating flash pattern
- Accepts standard PL-3 plugs
- Operating voltage 9-30VDC, suitable for 12V or 24V systems

BULK P/N	POLYPACK P/N	DESCRIPTION	QTY
<b>4" ROUND WARNING LAMPS - 22 DIODES</b>			
SLL43AB1	SLL43AB1P	12V-24V Function 1	10
SLL43AB2	SLL43AB2P	12V-24V Function 2	10
SLL43AKB1	SLL43AKB1P	12V-24V Function 1, kit with A45GB & A45PB	10
SLL43AKB2	SLL43AKB2P	12V-24V Function 2, kit with A45GB & A45PB	10
<b>ACCESSORIES</b>			
A45GB	A45GBP	Grommet, 4" round	50
A45PB	A45PBP	Pigtail, 3-wire	100
A47PB	A47PBP	Right angle pigtail, 3-wire	100

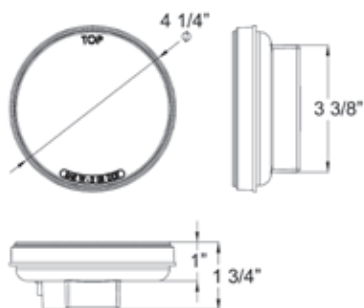

HOLE CUT-OUT: 4.5"

<b>FMVSS</b>	W-2
<b>MATERIALS</b>	Polycarbonate lens and housing
<b>VOLT/AMP</b>	12.8VDC - 0.56A
<b>WT/DIMS</b>	.60 lbs. / 4.25" x 4.25" x 1.75"
<b>WARRANTY</b>	Lifetime LED Warranty



## SLL72 SERIES 6" Oval Sealed LED Warning Lamps

- Sonically sealed, waterproof
- Flashing lights with triple-flash function, meeting SAE J595 and J845 standards for Class 2 and Class 3 directional warning lamps
- Use two Function 1 or Function 2 lights for synchronous flashing or pair a Function 1 with a Function 2 light for alternating flash pattern
- Accepts standard PL-3 plugs
- Operating voltage 9-30VDC, suitable for 12V or 24V systems



LED WARNING LIGHTS



SLL72AB1  
SLL72AB2

BULK P/N	POLYPACK P/N	DESCRIPTION	QTY
<b>6" OVAL WARNING LAMPS - 22 DIODES</b>			
SLL72AB1	SLL72AB1P	12V-24V Function 1	10
SLL72AB2	SLL72AB2P	12V-24V Function 2	10
SLL72AKB1	SLL72AKB1P	12V-24V Function 1, kit with A70GB & A45PB	10
SLL72AKB2	SLL72AKB2P	12V-24V Function 2, kit with A70GB & A45PB	10
<b>ACCESSORIES</b>			
A70GB	A70GBP	Grommet, 6" oval	50
A45PB	A45PBP	Pigtail, 3-wire	100
A47PB	A47PBP	Right angle pigtail, 3-wire	100

<b>FMVSS</b>	W-2
<b>MATERIALS</b>	Polycarbonate lens and housing
<b>VOLT/AMP</b>	12.8VDC - 0.54A
<b>WT/DIMS</b>	.62 lbs. / 6.5" x 2.375" x 1.75"
<b>WARRANTY</b>	Lifetime LED Warranty



HOLE CUT-OUT: 6.85" x 2.5" (1.25" R)



## SLL93 SERIES 7" Round LED Warning Lights for Surface Mount

- 8-LED school bus warning lights
- Acrylic lens, die cast aluminum base plate
- Sealed, waterproof design



SLL93RB



SLL93AB



SLL93AB with A94VB

BULK P/N	POLYPACK P/N	DESCRIPTION	QTY
<b>RED WARNING LIGHTS - 8 DIODES</b>			
SLL93RB	SLL93RBP	Warning light, 12V	5
<b>YELLOW WARNING LIGHTS - 8 DIODES</b>			
SLL93AB	SLL93ABP	Warning light, 12V	5
<b>ACCESSORIES</b>			
A94VB	A94VBP	Black Steel Visor	25

<b>FMVSS</b>	W2 SAE J887
<b>MATERIALS</b>	Acrylic len, die cast aluminum base
<b>VOLT/AMP</b>	12.8VDC - 2.0A
<b>WT/DIMS</b>	1.3875lb. / 7.25" x 7.25" x 1.9"
<b>WARRANTY</b>	Lifetime LED Warranty

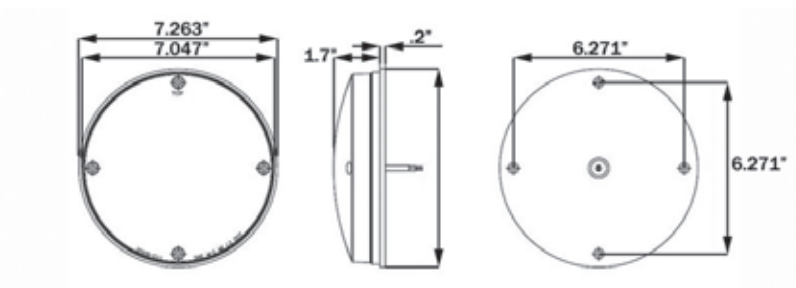

## GloLight® M1 SERIES 6.5" LED Marker/Clearance Lights

### PATENTED TECHNOLOGY

- Sealed, waterproof design
- Hard wired, includes separate ground wire

BULK P/N	POLYPACK P/N	DESCRIPTION	QTY
<b>YELLOW - 13 DIODES</b>			
11212307B	11212355P	.180 male bullets	50
11212376B	11212356P	Clear lens, .180 male bullets	50
-	11212335P	Kit: .180 male bullets, chrome bezel	10
-	11212336P	Clear lens kit: .180 male bullets, chrome bezel	10
<b>RED - 13 DIODES</b>			
11212309B	11212357P	.180 male bullets	50
11212378B	11212358P	Clear lens, .180 male bullets	50
-	11212337P	Kit: .180 male bullets, chrome bezel	10
-	11212338P	Clear lens kit: .180 male bullets, chrome bezel	10
<b>ACCESSORIES</b>			
00212317B	00212327P	Bezel	200/20

<b>FMVSS</b>	P2
<b>MATERIALS</b>	Polycarbonate lens, housing and bezel
<b>VOLT/AMP</b>	12.8VDC - 0.12A
<b>WT/DIMS</b>	.132 lbs. / 6.625" x 2.188" x 1"
<b>WARRANTY</b>	Three Year Warranty

**GloLight®**

*Panelite*  
MILLENNIUM SERIES™



M1 LED WITH BEZEL



M1 CLEAR LENS LED WITH BEZEL

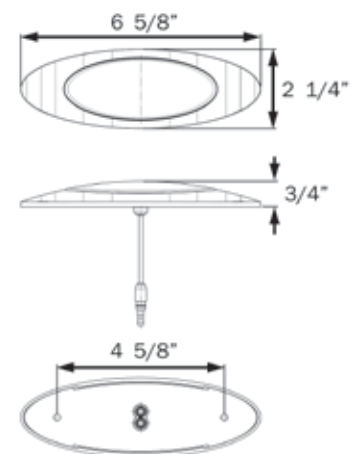

HOLE CUT-OUT: 1.5"

**GloLight**

**Panelite**  
MILLENNIUM SERIES

## GloLight® M3 SERIES 3" LED Marker/Clearance Lights

PATENTED TECHNOLOGY

- Sealed, waterproof design
- Hard wired, includes separate ground wire



M3 LED WITH BEZEL



M3 CLEAR LENS LED WITH BEZEL

BULK P/N	POLYPACK P/N	DESCRIPTION	QTY
<b>YELLOW - 5 DIODES</b>			
11212207B	11212255P	.180 male bullets	50
11212276B	11212256P	Clear lens, .180 male bullets	50
-	11212235P	Kit: .180 male bullets with chrome bezel	10
-	11212236P	Clear lens kit: .180 male bullets with chrome bezel	10
<b>RED - 5 DIODES</b>			
11212209B	11212257P	.180 male bullets	50
11212278B	11212258P	Clear lens, .180 male bullets	50
-	11212237P	Kit: .180 male bullets with chrome bezel	10
-	11212238P	Clear lens kit: .180 male bullets with chrome bezel	10
<b>ACCESSORIES</b>			
00212217B	00212227P	Bezel	500/20

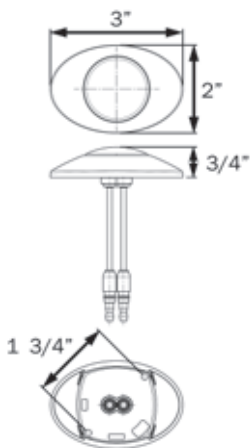

HOLE CUT-OUT:  
1.375"

<b>FMVSS</b>	P2
<b>MATERIALS</b>	Polycarbonate lens, housing and bezel
<b>VOLT/AMP</b>	12.8VDC - 0.12A
<b>WT/DIMS</b>	.132 lbs. / 3" x 2" x 1"
<b>WARRANTY</b>	Three Year Warranty

## GloLight® M5 SERIES 4" LED Marker/Clearance Lights

### PATENTED TECHNOLOGY

- Sealed, waterproof design
- Hard wired, includes separate ground wire

BULK P/N	POLYPACK P/N	DESCRIPTION	QTY
<b>YELLOW - 6 DIODES</b>			
11212700B	11212708P	.180 male bullets	10
11212702B	11212710P	Clear lens, .180 male bullets	10
-	11212704P	Kit: .180 male bullets with chrome bezel	10
-	11212706P	Clear lens kit: .180 male bullets with chrome bezel	10
<b>RED - 6 DIODES</b>			
11212701B	11212709P	.180 male bullets	10
11212703B	11212711P	Clear lens, .180 male bullets	10
-	11212705P	Kit: .180 male bullets with chrome bezel	10
-	11212707P	Clear lens kit: .180 male bullets with chrome bezel	10
<b>ACCESSORIES</b>			
00212717B	00212727P	Bezel	500/20

<b>FMVSS</b>	P2
<b>MATERIALS</b>	Polycarbonate lens, housing and bezel
<b>VOLT/AMP</b>	12.8VDC - 0.033A
<b>WT/DIMS</b>	.066 lb. / 4.156" x 1.5" x .75"
<b>WARRANTY</b>	Three Year Warranty

**GloLight®**

*Panelite*  
MILLENNIUM SERIES™



M5 LED WITH BEZEL



M5 CLEAR LENS LED WITH BEZEL



HOLE CUT-OUT: 1"

LED MILLENNIUM SERIES



## M1 SERIES Millennium Series® 6.5" Sealed LED Marker/Clearance Lights

- Sealed, waterproof design
- Hard wired, includes separate ground wire
- Available with .180 male bullets or metripack connector
- Choose from light only or kit with chrome bezel



M1 LED WITH BEZEL



M1 CLEAR LENS LED WITH BEZEL



M1 LED WITH BEZEL



M1 CLEAR LENS LED WITH BEZEL

BULK P/N	POLYPACK P/N	DESCRIPTION	QTY
<b>YELLOW - 4 DIODES</b>			
00212307B	00212355P	.180 male bullets	50/10
00212376B	00212356P	Clear lens, .180 male bullets	50/10
-	00212335P	Kit: .180 male bullets, bezel	10
-	00212336P	Kit: Clear lens, .180 male bullets, bezel	10
-	00212365P	Metripack connector	10
-	00212345P	Kit: Metripack connector, bezel	10
-	00212346P	Kit: Clear lens, metripack connector, bezel	10
<b>RED - 4 DIODES</b>			
00212309B	00212357P	.180 male bullets	50/10
00212378B	00212358P	Clear lens, .180 male bullets	50/10
-	00212337P	Kit: .180 male bullets, bezel	10
-	00212338P	Kit: Clear lens, .180 male bullets, bezel	10
00212316B	00212367P	Metripack connector	100/10
00212386B	00212368P	Clear lens, metripack connector	100/10
-	00212347P	Kit: Metripack connector, bezel	10
<b>ACCESSORIES</b>			
00212317B	00212327P	Bezel	200/20



FMVSS	P2
MATERIALS	Polycarbonate lens, housing and bezel
VOLT/AMP	12.8VDC - 0.12A
WT/DIMS	.132 lbs. / 6.625" x 2.188" x 1"
WARRANTY	Three Year Warranty

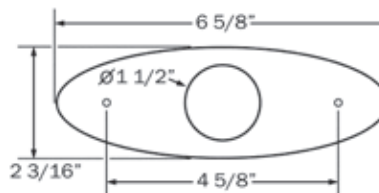

HOLE CUT-OUT: 1.5"

## M3 SERIES Millennium Series® 3" Sealed LED Marker/Clearance Lights

- Sealed, waterproof design
- Hard wired, includes separate ground wire
- Available with .180 male bullets or metripack connector
- Choose from light only or kit with chrome bezel

BULK P/N	POLYPACK P/N	DESCRIPTION	QTY
<b>YELLOW - 2 DIODES</b>			
00212207B	00212255P	.180 male bullets	50/10
00212276B	00212256P	Clear lens, .180 male bullets	50/10
-	00212235P	Kit: .180 male bullets, bezel	10
-	00212236P	Kit: Clear lens, .180 male bullets, bezel	10
00212213B	00212263P	Clear lens, metripack connector	50/10
<b>RED - 2 DIODES</b>			
00212209B	00212257P	.180 male bullets	50/10
00212278B	00212258P	Clear lens, .180 male bullets	50/10
-	00212237P	Kit: .180 male bullets, bezel	10
-	00212238P	Kit: Clear lens, .180 male bullets, bezel	10
-	00212254P	Clear lens, metripack connector	100
<b>ACCESSORIES</b>			
00212217B	00212227P	Bezel	500/20

<b>FMVSS</b>	P2
<b>MATERIALS</b>	Polycarbonate lens, housing and bezel
<b>VOLT/AMP</b>	12.8VDC - 0.36A
<b>WT/DIMS</b>	.132 lbs. / 3" x 2" x 1"
<b>WARRANTY</b>	Three Year Warranty

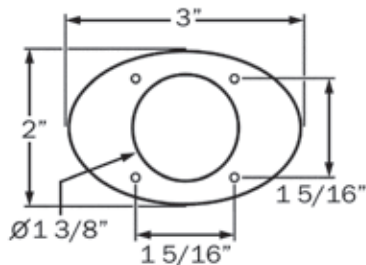

HOLE CUT-OUT: 1.375"

Panelite  
MILLENNIUM SERIES™



M3 LED WITH BEZEL



M3 CLEAR LENS LED WITH BEZEL



M3 LED WITH BEZEL



M3 CLEAR LENS LED WITH BEZEL





## M4 SERIES Millennium Series® 9" Sealed LED Lights

- Sealed, waterproof design
- Hard wired, includes separate ground wire
- Chrome trim ring included in kits or available separately

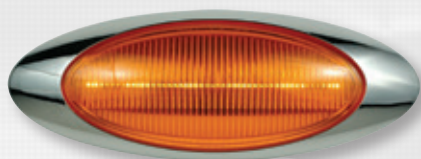

M4 LED MARKER/CLEARANCE LIGHTS WITH BEZEL

BULK P/N	POLYPACK P/N	DESCRIPTION	QTY
<b>YELLOW MARKER/CLEARANCE - 6 DIODES</b>			
00212104B	00212155P	.180 male bullets	10
-	00212135P	Kit: .180 male bullets, bezel	10
<b>RED MARKER/CLEARANCE - 6 DIODES</b>			
-	00212157P	.180 male bullets	10
-	00212137P	Kit: .180 male bullets, bezel	10
<b>ACCESSORIES</b>			
00212117B	00212127P	Bezel	70/20

<b>FMVSS</b>	P2
<b>MATERIALS</b>	Polycarbonate lens, housing and bezel
<b>VOLT/AMP</b>	12.8VDC - 0.090A
<b>WT/DIMS</b>	.132 lbs. / 9" x 3.25" x 1"
<b>WARRANTY</b>	Three Year Warranty

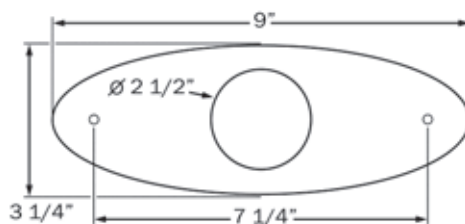

HOLE CUT-OUT: 2.5"



## M5 SERIES

### Millennium Series® 4" Sealed LED Marker/Clearance Lights

- Sealed, waterproof design
- Hard wired, includes separate ground wire
- Available with .180 male bullets or metripack connector
- Choose from light only or kit with chrome bezel



M5 LED WITH BEZEL



M5 CLEAR LENS LED WITH BEZEL



M5 LED WITH BEZEL



M5 CLEAR LENS LED WITH BEZEL

BULK P/N	POLYPACK P/N	DESCRIPTION	QTY
<b>YELLOW - 3 DIODES</b>			
00212700B	00212708P	.180 male bullets	10
00212702B	00212710P	Clear lens, .180 male bullets	10
-	00212704P	Kit: .180 male bullets, bezel	10
-	00212706P	Kit: Clear lens, .180 male bullets, bezel	10
-	00212712P	Clear lens, metripack connector	10
<b>RED - 3 DIODES</b>			
00212701B	00212709P	.180 male bullets	10
00212703B	00212711P	Clear lens, .180 male bullets	10
-	00212705P	Kit: .180 male bullets, bezel	10
-	00212707P	Kit: Clear lens, .180 male bullets, bezel	10
<b>ACCESSORIES</b>			
00212717B	00212727P	Bezel	500/20

<b>FMVSS</b>	P2
<b>MATERIALS</b>	Polycarbonate lens, housing and bezel
<b>VOLT/AMP</b>	12.8VDC - 0.033A
<b>WT/DIMS</b>	.066 lb. / 4.156" x 1.5" x .75"
<b>WARRANTY</b>	Three Year Warranty

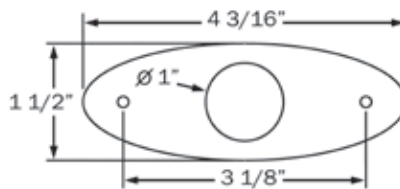

HOLE CUT-OUT: 1"





## MCL11S SERIES 3/4" Sealed LED Marker/Clearance Lights with Theft-Deterrent Design



### PATENTED TECHNOLOGY

- Sealed, waterproof design
- Recess mount lights with theft-deterrent mounting design
- Easy to install: insert light into mounting hole and secure with locking ring
- PC rated: fulfills requirement for marker and clearance light when properly mounted



MCL11SAKB

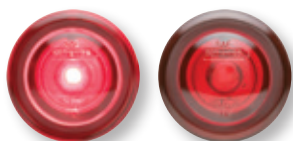

MCL11SRKB

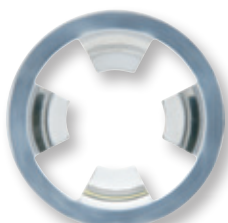

A11SRB

BULK P/N	POLYPACK P/N	DESCRIPTION	QTY
<b>YELLOW - 1 DIODE</b>			
MCL11SAB	MCL11SABP	Light with gasket, .180 bullets	50
MCL11SAKB	MCL11SAKBP	Light with gasket and locking ring .180 bullets	50
MCL11SAK1B	MCL11AK1BP	Light with gasket and locking ring	50
<b>RED - 1 DIODE</b>			
MCL11SRB	MCL11SRBP	Light with gasket, .180 bullets	50
MCL11SRKB	MCL11SRKBP	Light with gasket and locking ring .180 bullets	50
MCL11SRK1B	MCL11SRKBP	Light with gasket and locking ring	50
<b>ACCESSORIES</b>			
A11SRB	A11SRBP	Stainless steel locking ring	100

<b>FMVSS</b>	PC
<b>MATERIALS</b>	Polycarbonate lens and housing, stainless steel locking ring, EPDM rubber gasket
<b>VOLT/AMP</b>	12.8VDC - .06A
<b>WT/DIMS</b>	.10 lbs. / 1" x 1" x .875"
<b>WARRANTY</b>	Lifetime LED Warranty

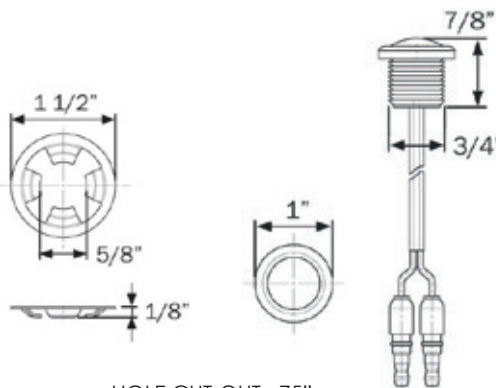

HOLE CUT-OUT: .75"

## MCL110 SERIES GloLight® Uni-Lite™ 3/4" LED Non-Directional Marker/Clearance Lights



### PATENTED TECHNOLOGY

- Sealed, waterproof design
- PC rated when mounted in any direction - 360 degrees!
- Hard wired, includes separate ground wire
- Choose from light only or kit with A11GB grommet



MCL110AB



MCL110RB



MCL110AKB



MCL110RKB

BULK P/N	POLYPACK P/N	DESCRIPTION	QTY
<b>YELLOW - PC RATED - 2 DIODES</b>			
MCL110AB	MCL110ABP	Light only	50
MCL110AKB	MCL110AKBP	Light with A11GB grommet	50
MCL110AKBF	MCL110AKBFP	Light kit with grommet, .156 female barrels on 8" leads	50
MCL110AKPG	MCL110AKPGP	Light with grommet, .180 bullets	50
<b>RED - PC RATED - 2 DIODES</b>			
MCL110RB	MCL110RBP	Light only	50
MCL110RKB	MCL110RKBP	Light with A11GB grommet	50
MCL110RKBF	MCL110AKBFP	Light kit with grommet, .156 female barrels on 8" leads	50
MCL110RKPG	MCL110RKPGP	Light with grommet, .180 bullets	50
<b>ACCESSORIES</b>			
A11GB	A11GBP	Grommet	100
A12GB	A12GBP	Sealing grommet, .070-.125"	100
A14GB	A14GBP	Sealing grommet, .125-.250"	100
A11PB	A11PBP	Black plastic snap-in flange	100
A11SSB	A11SSBP	Stainless steel grommet cover	100
A11AXB	A11AXBP	Yellow reflector	100
A11RXB	A11RXBP	Red reflector	100

<b>FMVSS</b>	PC
<b>MATERIALS</b>	Polycarbonate lens and housing
<b>VOLT/AMP</b>	12.8VDC - 0.08A
<b>WT/DIMS</b>	.022 lbs. / .073" x .073" x 0.938"
<b>WARRANTY</b>	Lifetime LED Warranty

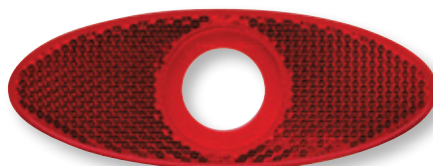
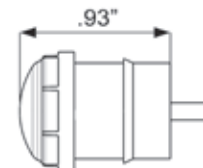
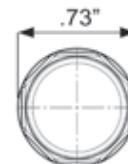

A11RXB

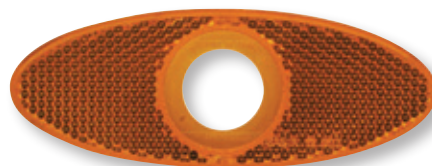

A11AXB

SEALED LED MARKER/  
CLEARANCE LIGHTS

**GloLight**

## MCL111 SERIES GloLight® Uni-Lite™ 3/4" Sealed LED Marker/Clearance Lights



### PATENTED TECHNOLOGY

- Sealed, waterproof design
- PC rated two diode models
- Hard wired, includes separate ground wire
- Available with optional plugs
- Choose from light only or kit with A11GB grommet
- Dual function models MCL121AK9PVG/RK9PVG provide a supplemental stop/turn function



MCL111AKB



MCL111RKB

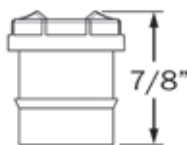
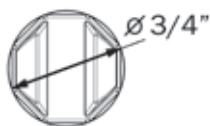

A11PB

BULK P/N	POLYPACK P/N	DESCRIPTION	QTY
<b>YELLOW - PC RATED - 2 DIODES</b>			
MCL111AB	MCL111ABP	Light only	50
MCL111AKB	MCL111AKBP	Light with A11GB grommet	50
MCL111AKPG	MCL111AKPGP	Kit with .180 male bullets, A11GB	50
MCL121AK9PVG	MCL121AK9PVG P	Supplemental turn - kit with closed grommet, .180 male bullets	20
<b>RED - PC RATED - 2 DIODES</b>			
MCL111RB	MCL111RBP	Light only	50
MCL111RKB	MCL111RKB P	Light with A11GB grommet	50
MCL111RKFP G	MCL111RKFP GP	Kit with .156 female bullets, A11GB	50
MCL111RKPG	MCL111RKPG P	Kit with .180 male bullets, A11GB	50
MCL121RK9PVG	MCL121RK9PVG P	Supplemental turn - kit with closed grommet, .180 male bullets	20
<b>ACCESSORIES</b>			
A11GB	A11GBP	Grommet	100
A12GB	A12GBP	Sealing grommet, .070-.125"	100
A14GB	A14GBP	Sealing grommet, .125-.250"	100
A11PB	A11PBP	Black plastic snap-in flange	100
A11SSB	A11SSBP	Stainless steel grommet cover	100
A11AXB	A11AXBP	Yellow reflector	100
A11RXB	A11RXBP	Red reflector	100

FMVSS	PC
MATERIALS	Polycarbonate lens and housing
VOLT/AMP	12.8VDC - 0.04A
WT/DIMS	.022 lbs. / .75" x .75" x 0.875"
WARRANTY	Lifetime LED Warranty

## MCL112 SERIES

### GloLight® Uni-Life™ 3/4" Sealed LED Marker/Clearance Lights



SEALED LED MARKER/  
CLEARANCE LIGHTS

#### PATENTED TECHNOLOGY

- Sealed, waterproof design
- P2 rated single diode models
- Hard wired, includes separate ground wire
- Choose from light only or kit with A11GB grommet



MCL112AKB



MCL112RKB

BULK P/N	POLYPACK P/N	DESCRIPTION	QTY
<b>YELLOW - P2 RATED - 1 DIODE</b>			
MCL112AB	MCL112ABP	Light only	50
MCL112AKB	MCL112AKBP	Light with A11GB grommet	50
<b>RED - P2 RATED - 1 DIODE</b>			
MCL112RB	MCL112RBP	Light only	50
MCL112RKB	MCL112RKBP	Light with A11GB grommet	50
<b>ACCESSORIES</b>			
A11GB	A11GBP	Grommet	100
A12GB	A12GBP	Sealing grommet, .070-.125"	100
A14GB	A14GBP	Sealing grommet, .125-.250"	100
A11PB	A11PBP	Black plastic snap-in flange	100
A11SSB	A11SSBP	Stainless steel grommet cover	100
A11AXB	A11AXBP	Yellow reflector	100
A11RXB	A11RXBP	Red reflector	100

<b>FMVSS</b>	P2
<b>MATERIALS</b>	Polycarbonate lens and housing
<b>VOLT/AMP</b>	12.8VDC - .047A
<b>WT/DIMS</b>	.022 lbs. / .75" x .75" x 0.875"
<b>WARRANTY</b>	Lifetime LED Warranty

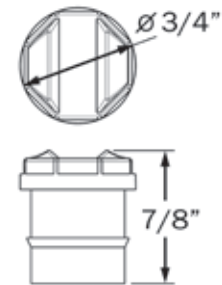



## MCL10 SERIES Uni-Lite™ 3/4" LED Non-Directional Marker/Clearance Lights



MCL10AB



MCL10RB



MCL10AKB



MCL10RKB

- Sonically sealed, waterproof
- PC rated when mounted in any direction - 360 degrees!
- Hard wired, includes separate ground wire
- Choose from light only or kit with A11GB grommet

BULK P/N	POLYPACK P/N	DESCRIPTION	QTY
<b>YELLOW - 1 DIODE</b>			
MCL10AB	MCL10ABP	Light only	50
MCL10AKB	MCL10AKBP	Light with A11GB grommet	50
MCL10CAK14B	MCL10CAK14BP	Clear lens light with A11GB grommet	50
<b>RED - 1 DIODE</b>			
MCL10RB	MCL10RBP	Light only	50
MCL10RKB	MCL10RKBP	Light with A11GB grommet	50
MCL10CRK14B	MCL10CRK14BP	Clear lens light with A11GB grommet	50
<b>ACCESSORIES</b>			
A11GB	A11GBP	Grommet	100
A12GB	A12GBP	Sealing grommet for material thickness .070 - .125"	100
A14GB	A14GBP	Sealing grommet for material thickness .125 - .250"	100
A11PB	A11PBP	Snap-in mounting flange	100
A11SSB	A11SSBP	Stainless steel trim ring	100
A11AXB	A11AXBP	Yellow oval reflector, self adhesive	100
A11RXB	A11RXBP	Red oval reflector, self adhesive	100

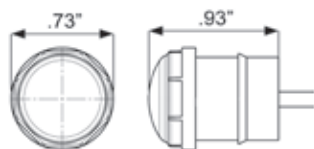

HOLE CUT-OUT: .75"

FMVSS	PC
MATERIALS	Polycarbonate lens and housing
VOLT/AMP	12.8VDC - .041A
WT/DIMS	.022 lbs. / .073" x .073" x .938"
WARRANTY	Lifetime LED Warranty

## MCL11 SERIES

### Uni-Lite™ 3/4" Sealed LED Marker/Clearance Lights



- Sealed, waterproof design
- Hard wired, includes separate ground wire

BULK P/N	POLYPACK P/N	DESCRIPTION	QTY
<b>YELLOW - PC RATED - 2 DIODES</b>			
MCL11AB	MCL11ABP	Light only	50
MCL11APG	MCL11APGP	Light with .180 male bullets	50
MCL11CAB	MCL11CABP	Light only, clear lens	50
MCL11AKB	MCL11AKBP	Kit with A11GB grommet	50
MCL11CAKB	MCL11CAKBP	Kit with A11GB, clear lens	50
MCL11CAKPG	-	Kit with A11GB, clear lens, .180 male bullets	50
MCL11CAKBF	-	Kit with A11GB, clear lens, .156 female barrels	50
MCL11AHPG	-	Kit with .180 male bullets, A11GB	50
MCL11AKAB	MCL11AKABP	Kit with .156 female barrels, A11GB	50
MCL11AKBF	MCL11AKBFP	Kit with .156 female barrels, A11GB	50
MCL11AK12B	-	Kit with 12" leads, A11GB	50
MCL11AK12PG	-	Kit with 12" leads, A11GB, .156 male bullets	50
MCL11AKPVG	-	Kit with sealed grommet, .180 male bullets	50
-	MCL11AKBSSP	Kit with 12" leads, A11GB, A11SSB	50
MCL11A24KB	-	Kit with A11GB grommet, 24V	50
MCL11AKPV4G	-	Kit with sealed grommet, .180 male bullets, 24V	50
<b>RED - PC RATED - 2 DIODES</b>			
MCL11RB	MCL11RBP	Light only	50
MCL11RPG	MCL11RPGP	Light with .180 male bullets	50
MCL11CRB	MCL11CRBP	Light only, clear lens	50
MCL11RKB	MCL11RKBP	Kit with A11GB grommet	50
MCL11CRKB	MCL11CRKBP	Kit with A11GB, clear lens	50
MCL11CRKPG	-	Kit with A11GB, clear lens, .180 male bullets	50
MCL11CRKBF	-	Kit with A11GB, clear lens, .156 female barrels	50
MCL11RHPG	-	Kit with .180 male bullets, A11GB	50
MCL11RKAB	-	Kit with .156 female connectors, A11GB	50
MCL11RKBF	MCL11RKBFP	Kit with .156 female barrels, A11GB	50
MCL11RK12B	-	Kit with 12" leads, A11GB	50
MCL11RK12PG	-	Kit with 12" leads, A11GB, .156 male bullets	50
MCL11RKPVG	-	Kit with sealed grommet, .180 male bullets	50
-	MCL11RKBSSP	Kit with 12" leads, A11GB, A11SSB	50
MCL11R24KB	-	Kit with A11GB grommet, 24V	50
MCL11RKPV4G	-	Kit with sealed grommet, .180 male bullets, 24V	50
MCL21RKPV4G	-	Kit with sealed grommet, male amp plug, supplemental turn function	10

See Accessories section at back of catalog or listing on previous pages for additional mounting options



MCL11AB



MCL11RB



MCL11AKB



MCL11RKB

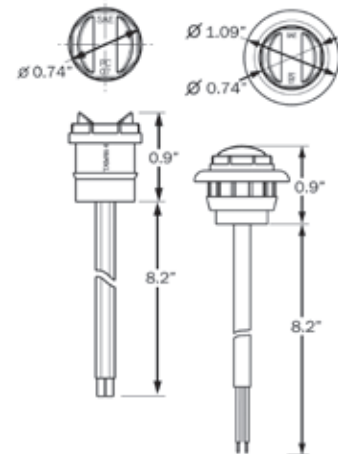

HOLE CUT-OUT: 0.75"

<b>FMVSS</b>	PC
<b>MATERIALS</b>	Polycarbonate lens and housing
<b>VOLT/AMP</b>	12.8VDC - 0.03A
<b>WT/DIMS</b>	.022 lbs. / .074" x .074" x 0.90"
<b>WARRANTY</b>	Lifetime LED Warranty

SEALED LED MARKER/  
CLEARANCE LIGHTS



## MCL12 SERIES Uni-Lite™ 3/4" Sealed LED Marker/Clearance Lights - P2



MCL12AKB



MCL12RKB



MCL12RK3B



MCL922RB

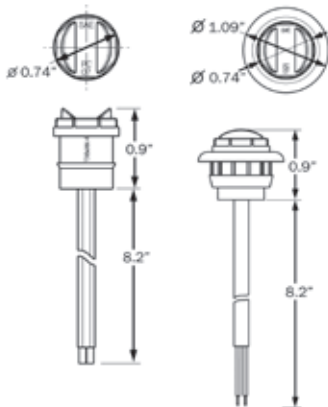

HOLE CUT-OUT: 0.75"

- Sealed, waterproof, P2 rated single diode models
- Hard wired, includes separate ground wire
- Three-piece identification light harnesses available; optional supplemental turn function
- MCL922RB is three-piece identification light bar

BULK P/N	POLYPACK P/N	DESCRIPTION	QTY
<b>YELLOW - P2 RATED - 1 DIODE</b>			
MCL12AB	MCL12ABP	Light only	50
MCL12AKB	MCL12AKBP	Light kit with A11GB	50
MCL12AKPG	-	Light kit with .180 male bullets, A11GB	50
MCL12AK156PG	-	Light kit with .156 male bullets, A11GB	50
<b>RED - P2 RATED - 1 DIODE</b>			
MCL12RB	MCL12RBP	Light only	50
MCL12RKB	MCL12RKBP	Light kit with A11GB	50
MCL12RKPG	-	Light kit with .180 male bullets, A11GB	50
MCL12RK156PG	-	Light kit with .156 male bullets, A11GB	50
<b>RED IDENTIFICATION LIGHT KIT WITH MOLDED HARNESS</b>			
MCL12RK3B	MCL12RK3BP	(3) red MCL12 lights	20
MCL12RK3RMB	-	(3) red MCL12 lights, weathertight plug	20
MCL22RK3B	-	(3) red MCL12 lights, supplemental turn function	20
MCL22RK4B	-	(3) red MCL12 lights, supplemental turn function, amp connector	20
<b>RED IDENTIFICATION LIGHT BAR</b>			
MCL922RB	MCL922RBP	(3) red MCL12 lights, molded bar, black	10
<b>ACCESSORIES</b>			
A11GB	A11GBP	Grommet	100
A12GB	A12GBP	Sealing grommet, .070-.125"	100
A14GB	A14GBP	Sealing grommet, .125-.250"	100
A11PB	A11PBP	Black plastic snap-in flange	100
A11SSB	A11SSBP	Stainless steel grommet cover	100
A11AXB	A11AXBP	Yellow reflector	100
A11RXB	A11RXBP	Red reflector	100
<b>RETAIL</b>			
MCL12AK		Yellow light kit, card/slipover blister	12
MCL12RK		Red light kit, card/slipover blister	12

FMVSS P2

**MATERIALS**

Polycarbonate lens and housing

**VOLT/AMP**

12.8VDC - 0.47A

**WT/DIMS**

.022 lbs. / .074" x .074" x 0.90"

**WARRANTY**

Lifetime LED Warranty



## MCL12AR SERIES Uni-Lite™ 3/4" Sealed LED Fender Lights



- Sealed, waterproof, P2 rated single diode lights pre-installed in durable ABS, surface mount bracket
- Hard wired, includes separate ground wire
- Available with clear or tinted lenses



MCL12ARRB  
MCL12ARLB

SEALED LED MARKER/  
CLEARANCE LIGHTS

BULK P/N	POLYPACK P/N	DESCRIPTION	QTY
		<b>YELLOW / RED FENDER LIGHTS</b>	
MCL12ARLB	MCL12ARLBP	Driver side assembly, 2-wire	50/20
MCL12ARRB	MCL12ARRBP	Passenger side assembly, 2-wire	50/20
MCL12CA2RLB	-	Driver side assembly, clear lens, self grounding	50
MCL12CA2RRB	-	Passenger side assembly, clear lens, self grounding	50
<b>ACCESSORIES</b>			
A11GB	A11GBP	Grommet	100

<b>FMVSS</b>	P2
<b>MATERIALS</b>	Polycarbonate lens and housing
<b>VOLT/AMP</b>	12.8VDC - 0.047A
<b>WT/DIMS</b>	.20 lbs. / 4.75" x 1.625" x 1.25"
<b>WARRANTY</b>	Lifetime LED Warranty

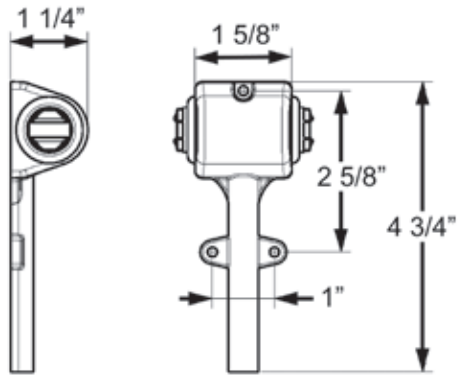

MCL12CA2RLB  
MCL12CA2RRB



## MCL21/23 SERIES 2" & 2.5" Sealed LED Beehive Style Marker/Clearance Lights

- Sonically sealed, waterproof
- Clearance, side marker, or rear tracking light applications
- Accepts standard two-pin PL-10 plug



MCL21AB



MCL21RB



MCL23AB



MCL23RB

BULK P/N	POLYPACK P/N	DESCRIPTION	QTY
<b>YELLOW - 8 DIODES</b>			
MCL21AB	MCL21ABP	2" light	20
MCL23AB	MCL23ABP	2.5" light	20
<b>RED - 8 DIODES</b>			
MCL21RB	MCL21RBP	2" light	20
MCL23RB	MCL23RBP	2.5" light	20
<b>ACCESSORIES</b>			
A46PB	A46PBP	Straight PL-10 plug, 6" lead	100
A86PB	A86PBP	Straight PL-10 plug, 18" lead	100
A54GB	A54GBP	2" Flush mount grommet	100
A54GK	A54GKP	2" Kit: A54GB and A46PB	100
A55CB	A55CBP	2" Chrome trim ring	20
A55GB	A55GBP	2.5" Flush mount grommet (open back)	50
A56GB	A56GBP	2.5" Recess mount grommet (closed back)	100
A57GB	A57GBP	2.5" Recess mount grommet (open back)	50
A55GK	A55GKP	2.5" Kit: A55GB and A46PB	100
A57GK	A57GKP	2.5" Kit: A57GB and A46PB	100
A57CB	A57CBP	2.5" Chrome trim ring	20
BK5557GB	BK5557GBP	2"/2.5" Cam-on mounting bracket	50

<b>FMVSS</b>	P2
<b>MATERIALS</b>	Polycarbonate lens and housing
<b>VOLT/AMP</b>	MCL21: 12.8VDC - 0.061A MCL23: 12.8VDC - 0.051A
<b>WT/DIMS</b>	MCL21: .110 lbs. / 2" x 2" x 1.75" MCL23: .176 lbs. / 2.5" x 2.5" x 2.313"
<b>WARRANTY</b>	Lifetime LED Warranty



MCL21 SERIES  
HOLE CUT-OUT: 2.313"

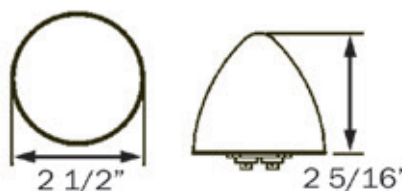

MCL23 SERIES  
HOLE CUT-OUT: 2.75"

## MCL155 SERIES GloLight® 2" Round Sealed LED Marker/Clearance Lights

**GloLight®**

### PATENTED TECHNOLOGY

- Sonically sealed, waterproof
- Accepts standard two-pin PL-10 plug
- Recess grommet and flange mount models available

BULK P/N	POLYPACK P/N	DESCRIPTION	QTY
<b>YELLOW - 6 DIODES</b>			
MCL155AB	MCL155ABP	Grommet mount	20
MCL155AFB	MCL155AFBP	Flange mount	20
<b>RED - 6 DIODES</b>			
MCL155RB	MCL155RBP	Grommet mount	20
MCL155RFB	MCL155RFBP	Flange mount	20
<b>ACCESSORIES</b>			
A46PB	A46PBP	Straight PL-10 plug, 6" lead	100
A86PB	A86PBP	Straight PL-10 plug, 18" lead	100
A54GB	A54GBP	2" Flush mount grommet	100
A54GK	A54GKP	2" Kit: A54GB and A46PB	100
A55CB	A55CBP	2" Chrome trim ring	20
BK5557GB	BK5557GBP	Cam-on mounting bracket	50

<b>FMVSS</b>	P2
<b>MATERIALS</b>	Polycarbonate lens and housing
<b>VOLT/AMP</b>	12.8VDC - 0.06A
<b>WT/DIMS</b>	Grommet Mount: .066 lbs. / 2" x 2" x 1" Flange Mount: .078 lbs. / 2.938" x 2.938" x .938"
<b>WARRANTY</b>	Lifetime LED Warranty



MCL155AB



MCL155RB



MCL155AFB



MCL155RFB

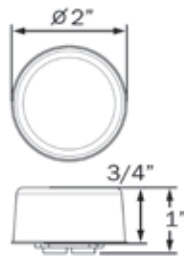

MCL155AB/RB

HOLE CUT-OUT: 2.313"

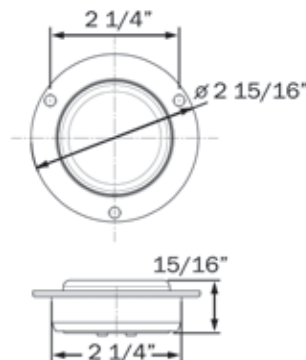

MCL155AFB/RFB

HOLE CUT-OUT: 2.313"

SEALED LED MARKER/  
CLEARANCE LIGHTS



## MCL55 SERIES 2" Round Sealed LED Marker/Clearance Lights

- Sonically sealed, waterproof
- Accepts standard two-pin PL-10 plug
- Available in 12V and 12-24V models



MCL55AB



MCL55RB

MCL55ACB  
MCL55RCB  
UCL55CB

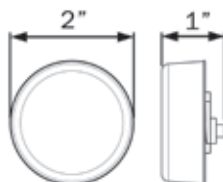

HOLE CUT-OUT: 2.313"



MCL55FRB

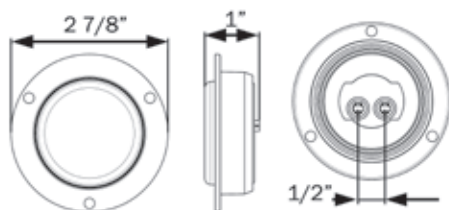

HOLE CUT-OUT: 2.313"

BULK P/N	POLYPACK P/N	DESCRIPTION	QTY
<b>YELLOW - 3 DIODES</b>			
MCL55AB	MCL55ABP	Grommet mount, 12V	20
MCL55ACB	MCL55ACBP	Clear lens grommet mount, 12V	20
MCL55A1224B	MCL55A1224BP	Grommet mount, 12-24V	20
MCL55AKB	MCL55AKBP	Kit with grommet and plug, 12V	20
<b>RED - 3 DIODES</b>			
MCL55RB	MCL55RBP	Grommet mount, 12V	20
MCL55RCB	MCL55RCBP	Clear lens grommet mount, 12V	20
MCL55R1224B	MCL55R1224BP	Grommet mount, 12-24V	20
MCL55RKB	MCL55RKBP	Kit with grommet and plug, 12V	20
MCL55FRB	MCL55FRBP	Flange mount, 12V	50
<b>UTILITY LIGHT - 3 DIODES</b>			
UCL55CB	UCL55CBP	White LED, 12V	20
<b>ACCESSORIES</b>			
A46PB	A46PBP	Straight PL-10 plug, 6" lead	100
A86PB	A86PBP	Straight PL-10 plug, 18" lead	100
A54GB	A54GBP	2" Flush mount grommet	100
A54GK	A54GKP	2" Kit: A54GB and A46PB	100
A55CB	A55CBP	2" Chrome trim ring	20
BK5557GB	BK5557GBP	Cam-on mounting bracket	50
<b>RETAIL</b>			
MCL55AK	Yellow kit with A54GB & A46PB, clam		12
MCL55RK	Red kit with A54GB & A46PB, clam		12

<b>FMVSS</b>	P2
<b>MATERIALS</b>	Polycarbonate lens and housing
<b>VOLT/AMP</b>	12.8VDC - 0.06A
<b>WT/DIMS</b>	MCL55: .066 lbs. / 2" x 2" x 1" MCL55FRB: .078 lbs. / 2.875" x 2.875" x 1"
<b>WARRANTY</b>	Lifetime LED Warranty

## MCL505 SERIES 2" Round Sealed LED ABS Lights

- Sonically sealed, waterproof
- Accept standard two-pin PL-10 plugs
- Available in grommet and flange mount models
- MCL505GABSB includes A54GB grommet



MCL505ABS

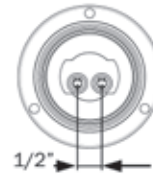
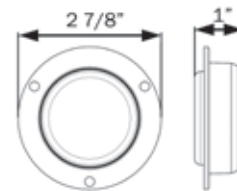

HOLE CUT-OUT: 2.313"

BULK P/N	POLYPACK P/N	DESCRIPTION	QTY
<b>YELLOW - 3 DIODES</b>			
MCL505ABS	MCL505ABSBP	Flange mount	50
MCL505GABS	MCL505GABSBP	Grommet mount kit, with A54GB grommet	20
<b>ACCESSORIES</b>			
A46PB	A46PBP	Straight PL-10 plug, 6" lead	100
A86PB	A86PBP	Straight PL-10 plug, 18" lead	100
A54GB	A54GBP	Standard flush mount grommet	100
A54GK	A54GKP	Kit: A54GB and A46PB	100
A55CB	A55CBP	Chrome trim ring	20
BK5557GB	BK5557GBP	Cam-on mounting bracket	50

<b>FMVSS</b>	P2
<b>MATERIALS</b>	Polycarbonate lens and housing
<b>VOLT/AMP</b>	12.8VDC - .047A
<b>WT/DIMS</b>	MCL505ABS: .078 lbs. / 2.875" x 2.875" x 1" MCL505GABS: .066 lbs. / 2" x 2" x 1"
<b>WARRANTY</b>	Lifetime LED Warranty



MCL505GABS

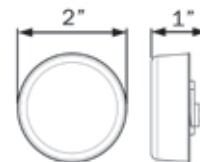

HOLE CUT-OUT: 2.313"

SEALED LED MARKER/  
CLEARANCE LIGHTS



MCL56AB



MCL56AFB



MCL56RB



MCL56RFB

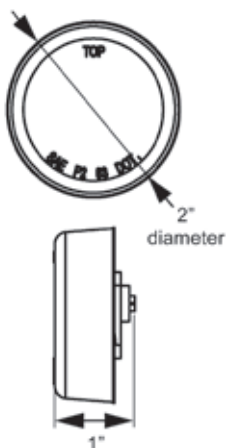

HOLE CUT-OUT: 2.313"

## MCL56 SERIES

### FLEET Count™ 2" Round Sealed LED Marker/Clearance Lights

- Sonically sealed, waterproof
- Accepts standard two-pin PL-10 plug
- Multiple mounting options available

BULK P/N	POLYPACK P/N	DESCRIPTION	QTY
<b>YELLOW - 1 DIODE</b>			
MCL56AB	MCL56ABP	Light only	20
MCL5AFB	MCL56AFBP	Flange mount	20
<b>RED - 1 DIODE</b>			
MCL56RB	MCL56RBP	Light only	20
MCL56RFB	MCL56RFBP	Flange mount	20
<b>ACCESSORIES</b>			
A46PB	A46PBP	Straight PL-10 plug, 6" lead	100
A86PB	A86PBP	Straight PL-10 plug, 18" lead	100
A54GB	A54GBP	2" Flush mount grommet	100
A54GK	A54GKP	2" Kit: A54GB and A46PB	100
A55CB	A55CBP	2" Chrome trim ring	20
BK5557GB	BK5557GBP	Cam-on mounting bracket	50
<b>RETAIL</b>			
MCL56AK		Yellow kit with A54GB & A46PB, clam	12
MCL56AS		Yellow light only, clam	12
MCL56RK		Red kit with A54GB & A46PB, clam	12
MCL56RS		Red light only, clam	12

<b>FMVSS</b>	P2
<b>MATERIALS</b>	Polycarbonate lens and housing
<b>VOLT/AMP</b>	12.8VDC - 0.045A
<b>WT/DIMS</b>	Grommet mount: .066 lbs. / 2" x 2" x 1" Flange mount: .071 lbs. / 2.938" x 2.938" x .938"
<b>WARRANTY</b>	Lifetime LED Warranty

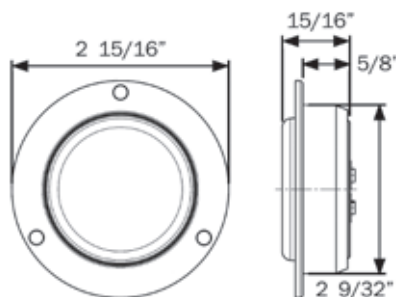

HOLE CUT-OUT: 2.313"

## MCL52 REFLEX SERIES

### 2" Round Sealed LED Marker/Clearance Lights with Reflex Lens and Flange

- Recess flange mount
- Sonically sealed, waterproof
- Hard wired, includes separate ground wire
- Built-in reflex eliminates the need for a separate reflector

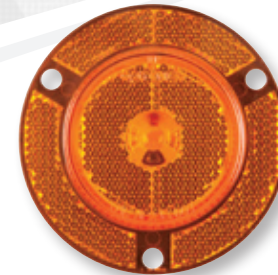
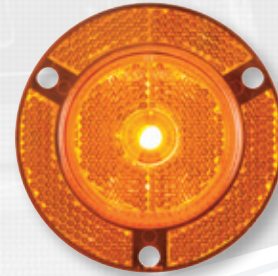

MCL52AHXB



MCL52RHXB

SEALED LED MARKER/  
CLEARANCE LIGHTS

BULK P/N	POLYPACK P/N	DESCRIPTION	QTY
<b>YELLOW - 7 DIODES</b>			
MCL52AHXB	MCL52AHXBP	Reflex flange	50
<b>RED - 7 DIODES</b>			
MCL52RHXB	MCL52RHXP	Reflex flange	50

<b>FMVSS</b>	A P2
<b>MATERIALS</b>	Polycarbonate lens and housing
<b>VOLT/AMP</b>	12.8VDC - 0.063A
<b>WT/DIMS</b>	.088 lbs. / 3.063" x 3.063" x .813"
<b>WARRANTY</b>	Lifetime LED Warranty

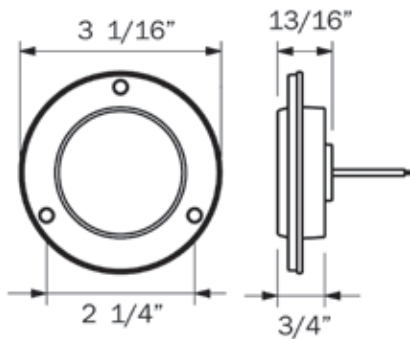

HOLE CUT-OUT: 2.313"



## MCL50 SERIES

### Miro-Flex™ 2" Round Sealed LED Marker/Clearance Lights

- Sonically sealed, waterproof
- Accepts standard two-pin PL-10 plug
- Multiple mounting options available



MCL50AB

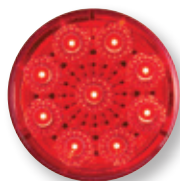
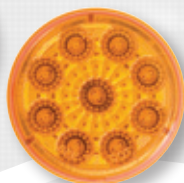

MCL50RB



BULK P/N	POLYPACK P/N	DESCRIPTION	QTY
<b>YELLOW - 9 DIODES</b>			
MCL50AB	MCL50ABP	Light only	20
<b>RED - 9 DIODES</b>			
MCL50RB	MCL50RBP	Light only	20
<b>ACCESSORIES</b>			
A46PB	A46PBP	Straight PL-10 plug, 6" lead	100
A86PB	A86PBP	Straight PL-10 plug, 18" lead	100
A54GB	A54GBP	2" Flush mount grommet	100
A54GK	A54GKP	2" Kit: A54GB and A46PB	100
A55CB	A55CBP	2" Chrome trim ring	20
BK5557GB	BK5557GBP	Cam-on mounting bracket	50



HOLE CUT-OUT: 2.313"

FMVSS	P2
MATERIALS	Polycarbonate lens and housing
VOLT/AMP	12.8VDC - 0.047A
WT/DIMS	.088 lbs. / 2" x 2" x 1.188"
WARRANTY	Lifetime LED Warranty



## MCL52/54 SERIES 2" Round Sealed LED Marker/Clearance Lights



- Sonically sealed, waterproof
- Available with standard PL-10 or optional weathertight connection
- PC rated: functions as both clearance and side marker light when properly mounted on a 45 degree angle
- Available in flange mount and grommet mount models



MCL54AB



MCL54RB

BULK P/N	POLYPACK P/N	DESCRIPTION	QTY
<b>YELLOW - 5 DIODES</b>			
MCL52AB	MCL52ABP	Flange mount, PL-10 connection	20
MCL52AMB	MCL52AMBP	Flange mount, weathertight connection; pigtail included	20
MCL54AB	MCL54ABP	Grommet mount, PL-10 connection	20
<b>RED - 5 DIODES</b>			
MCL52RB	MCL52RBP	Flange mount, PL-10 connection	20
MCL52RMB	MCL52RMBP	Flange mount, weathertight connection; pigtail included	20
MCL54RB	MCL54RBP	Grommet mount, PL-10 connection	20
<b>ACCESSORIES</b>			
A46PB	A46PBP	Straight PL-10 plug, 6" lead	100
A86PB	A86PBP	Straight PL-10 plug, 18" lead	100
AL42PB	AL42PBP	Weathertight pigtail	100
A54GB	A54GBP	2" Flush mount grommet	100
A54GK	A54GKP	2" Kit: A54GB and A46PB	100
A55CB	A55CBP	2" Chrome trim ring	20
BK5557GB	BK5557GBP	Cam-on mounting bracket	50
A52GB	-	Gasket for flange mount, black	100

<b>FMVSS</b>	P2 PC
<b>MATERIALS</b>	Polycarbonate lens and housing
<b>VOLT/AMP</b>	12.8VDC - 0.063A
<b>WT/DIMS</b>	Flange mount: .088 lbs. / 2.938" x 2.938" x 0.938" Grommet mount: .066 lbs. / 2.063" x 2.063" x 0.875"
<b>WARRANTY</b>	Lifetime LED Warranty



MCL52AB

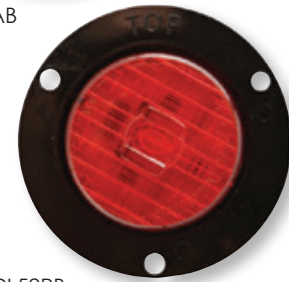

MCL52RB



detail of weathertight connection on MCL52AMB/RMB; pigtail included

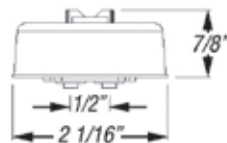

MCL54

HOLE CUT-OUT: 2.313"

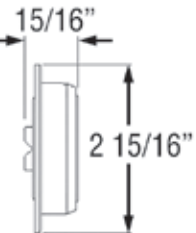
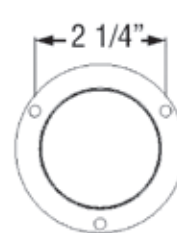

MCL52

HOLE CUT-OUT: 2.313"

SEALED LED MARKER/  
CLEARANCE LIGHTS



## MCL157 SERIES GloLight® 2.5" Round Sealed LED Marker/Clearance Lights

### PATENTED TECHNOLOGY

- Sonically sealed, waterproof
- Accepts standard two-pin PL-10 plug



MCL157AB



MCL157RB



BULK P/N	POLYPACK P/N	DESCRIPTION	QTY
<b>YELLOW - 9 DIODES</b>			
MCL157AB	MCL157ABP	Light only	20
<b>RED - 9 DIODES</b>			
MCL157RB	MCL157RBP	Light only	20
<b>ACCESSORIES</b>			
A46PB	A46PBP	Straight PL-10 plug, 6" lead	100
A86PB	A86PBP	Straight PL-10 plug, 18" lead	100
A55GB	A55GBP	Flush mount grommet (open back)	50
A56GB	A56GBP	Recess mount grommet (closed back)	100
A57GB	A57GBP	Recess mount grommet (open back)	50
A55GK	A55GKP	Kit: A55GB and A46PB	100
A57GK	A57GKP	Kit: A57GB and A46PB	100
A57CB	A57CBP	Chrome trim ring	20
BK5557GB	BK5557GBP	Cam-on mounting bracket	50

FMVSS	P2
MATERIALS	Polycarbonate lens and housing
VOLT/AMP	12.8VDC - 0.099A
WT/DIMS	.132 lbs. / 2.5" x 2.5" x 1.125"
WARRANTY	Lifetime LED Warranty

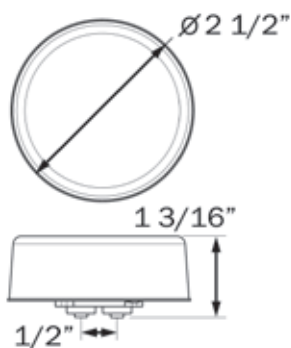

HOLE CUT-OUT: 2.75"

## MCL57 SERIES 2.5" Round Sealed LED Marker/Clearance Lights

- Sonically sealed, waterproof
- Accepts standard two-pin PL-10 plug
- Available in 12V and 24V models



SEALED LED MARKER/  
CLEARANCE LIGHTS

BULK P/N	POLYPACK P/N	DESCRIPTION	QTY
<b>YELLOW - 3 DIODES</b>			
MCL57AB	MCL57ABP	Light only, 12V	20
MCL57A24B	MCL57A24BP	Light only, 24V	20
MCL57ACB	MCL57ACBP	Clear lens light only, 12V	20
MCL57AKB	MCL57AKBP	Kit with grommet and plug	20
<b>RED - 3 DIODES</b>			
MCL57RB	MCL57RBP	Light only, 12V	20
MCL57R1224B	MCL57R1224BP	Light only, 12-24V	20
MCL57R24B	MCL57R24BP	Light only, 24V	20
MCL57RCB	MCL57RCBP	Clear lens light only, 12V	20
MCL57RKB	MCL57RKBP	Kit with grommet and plug	20
<b>ACCESSORIES</b>			
A46PB	A46PBP	Straight PL-10 plug, 6" lead	100
A86PB	A86PBP	Straight PL-10 plug, 18" lead	100
A55GB	A55GBP	Flush mount grommet (open back)	50
A56GB	A56GBP	Recess mount grommet (closed back)	100
A57GB	A57GBP	Recess mount grommet (open back)	50
A55GK	A55GKP	Kit: A55GB and A46PB	100
A57GK	A57GKP	Kit: A57GB and A46PB	100
A57CB	A57CBP	Chrome trim ring	20
BK5557GB	BK5557GBP	Cam-on mounting bracket	50
<b>RETAIL</b>			
MCL57AK		Yellow kit with A55GB & A46PB, clam	12
MCL57RK		Red kit with A55GB & A46PB, clam	12

FMVSS	P2
MATERIALS	Polycarbonate lens and housing
VOLT/AMP	12.8VDC - 0.096A
WT/DIMS	.132 lbs. / 2.5" x 2.5" x 1"
WARRANTY	Lifetime LED Warranty



MCL57AB



MCL57RB



MCL57ACB/RCB

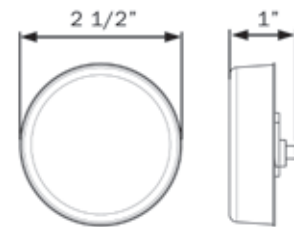

HOLE CUT-OUT: 2.75"



MCL527AB



MCL527AFB



MCL527RB



MCL527RFB

## MCL527 SERIES

### FLEET Count™ 2.5" Round Sealed LED Marker/Clearance Lights

- Sonically sealed, waterproof
- Accepts standard two-pin PL-10 plug
- Multiple mounting options available

BULK P/N	POLYPACK P/N	DESCRIPTION	QTY
<b>YELLOW - 2 DIODES</b>			
MCL527AB	MCL527ABP	Light only	20
MCL527AFB	MCL527AFBP	Flange mount	20
<b>RED - 2 DIODES</b>			
MCL527RB	MCL527RBP	Light only	20
MCL527RFB	MCL527RFBP	Flange mount	20
<b>ACCESSORIES</b>			
A46PB	A46PBP	Straight PL-10 plug, 6" lead	100
A86PB	A86PBP	Straight PL-10 plug, 18" lead	100
A55GB	A55GBP	Flush mount grommet (open back)	50
A56GB	A56GBP	Recess mount grommet (closed back)	100
A57GB	A57GBP	Recess mount grommet (open back)	50
A55GK	A55GKP	Kit: A55GB and A46PB	100
A57GK	A57GKP	Kit: A57GB and A46PB	100
A57CB	A57CBP	Chrome trim ring	20
BK5557GB	BK5557GBP	Cam-on mounting bracket	50
<b>RETAIL</b>			
MCL527AK		Yellow kit with A57GB & A46PB, clam	12
MCL527AS		Yellow light only, clam	12
MCL527RK		Red kit with A57GB & A46PB, clam	12
MCL527RS		Red light only, clam	12

<b>FMVSS</b>	P2
<b>MATERIALS</b>	Polycarbonate lens and housing
<b>VOLT/AMP</b>	12.8VDC - 0.034A
<b>WT/DIMS</b>	Grommet Mount: .088 lbs. / 2.5" x 2.5" x 1.063" Flange Mount: .088lbs. / 3.438" x 3.438" x .938"
<b>WARRANTY</b>	Lifetime LED Warranty

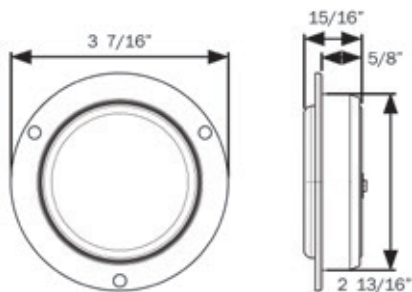

HOLE CUT-OUT: 2.75"

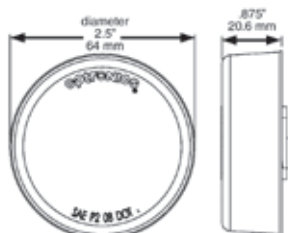

HOLE CUT-OUT: 2.75"

## MCL51 SERIES

### Miro-Flex™ 2.5" Round Sealed LED Marker/Clearance Lights

- Sonically sealed, waterproof
- Accepts standard two-pin PL-10 plug
- Multiple mounting options available

BULK P/N	POLYPACK P/N	DESCRIPTION	QTY
<b>YELLOW - 3 DIODES</b>			
MCL51AB	MCL51ABP	Light only	20
<b>RED - 3 DIODES</b>			
MCL51RB	MCL51RBP	Light only	20
<b>ACCESSORIES</b>			
A46PB	A46PBP	Straight PL-10 plug, 6" lead	100
A86PB	A86PBP	Straight PL-10 plug, 18" lead	100
A55GB	A55GBP	Flush mount grommet (open back)	50
A56GB	A56GBP	Recess mount grommet (closed back)	100
A57GB	A57GBP	Recess mount grommet (open back)	50
A55GK	A55GKP	Kit: A55GB and A46PB	100
A57GK	A57GKP	Kit: A57GB and A46PB	100
A57CB	A57CBP	Chrome trim ring	20
BK5557GB	BK5557GBP	Cam-on mounting bracket	50

<b>FMVSS</b>	P2
<b>MATERIALS</b>	Polycarbonate lens and housing
<b>VOLT/AMP</b>	12.8VDC - 0.033A
<b>WT/DIMS</b>	.088 lbs. / 2.5" x 2.5" x 1.188"
<b>WARRANTY</b>	Lifetime LED Warranty



MCL51AB



MCL51RB

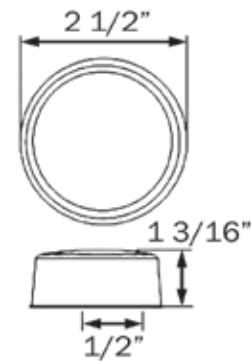

HOLE CUT-OUT: 2.75"

SEALED LED MARKER/  
CLEARANCE LIGHTS



## MCL58 SERIES 2.5" Round Sealed LED Marker/Clearance Lights



- Sonically sealed, waterproof
- Available with standard PL-10 or optional weathertight connection
- Multiple mounting options available
- PC rated: functions as both clearance and side marker light when properly mounted on a 45 degree angle



BULK P/N	POLYPACK P/N	DESCRIPTION	QTY
<b>YELLOW - 7 DIODES</b>			
MCL58AB	MCL58ABP	Light only	20
MCL58ACB	MCL58ACBP	Clear lens, yellow diodes, light only	20
MCL58AMFB	MCL58AMFBP	Flange mount, weathertight connection	50
<b>RED - 7 DIODES</b>			
MCL58RB	MCL58RBP	Light only	20
MCL58RMFB	MCL58RMFBP	Flange mount, weathertight connection	50
<b>ACCESSORIES</b>			
A46PB	A46PBP	Straight PL-10 plug, 6" lead	100
A86PB	A86PBP	Straight PL-10 plug, 18" lead	100
AL42PB	AL42PBP	Weathertight pigtail	100
A55GB	A55GBP	Flush mount grommet (open back)	50
A56GB	A56GBP	Recess mount grommet (closed back)	100
A57GB	A57GBP	Recess mount grommet (open back)	50
A55GK	A55GKP	Kit: A55GB and A46PB	100
A57GK	A57GKP	Kit: A57GB and A46PB	100
A57CB	A57CBP	Chrome trim ring	20
BK5557GB	BK5557GBP	Cam-on mounting bracket	50

<b>FMVSS</b>	P2 PC
<b>MATERIALS</b>	Polycarbonate lens and housing
<b>VOLT/AMP</b>	12.8VDC - 0.057A
<b>WT/DIMS</b>	Grommet Mount: .132 lbs. / 2.5" x 2.5" x 0.938" Flange Mount: .112lbs. / 3.42" x 3.42" x 1.30"
<b>WARRANTY</b>	Lifetime LED Warranty

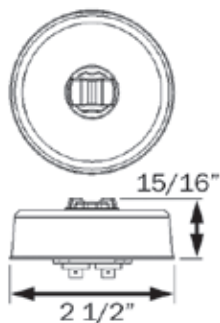

HOLE CUT-OUT: 2.75"

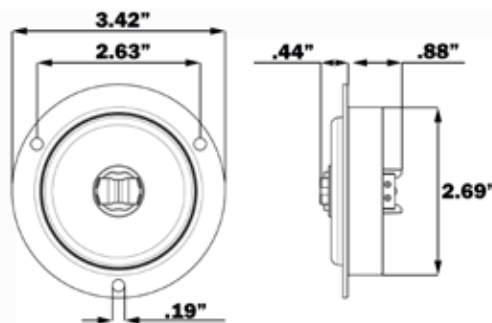

HOLE CUT-OUT: 2.75"

## MCL59 SERIES

### 2.5" Round Sealed LED Marker/ Clearance Lights with Reflex

- Sonically sealed, waterproof
- Accepts standard two-pin PL-10 plug
- Multiple mounting options available
- Built-in reflex eliminates the need for a separate reflector

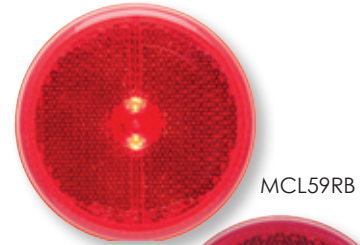
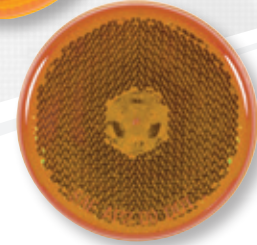
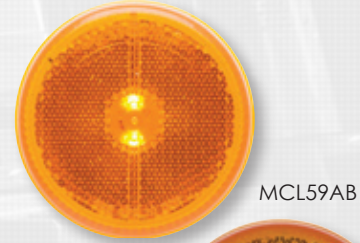

BULK P/N	POLYPACK P/N	DESCRIPTION	QTY
<b>YELLOW - 8 DIODES</b>			
MCL59AB	MCL59ABP	Light only	20
<b>RED - 8 DIODES</b>			
MCL59RB	MCL59RBP	Light only	20
<b>ACCESSORIES</b>			
A46PB	A46PBP	Straight PL-10 plug, 6" lead	100
A86PB	A86PBP	Straight PL-10 plug, 18" lead	100
A55GB	A55GBP	Flush mount grommet (open back)	50
A56GB	A56GBP	Recess mount grommet (closed back)	100
A57GB	A57GBP	Recess mount grommet (open back)	50
A55GK	A55GKP	Kit: A55GB and A46PB	100
A57GK	A57GKP	Kit: A57GB and A46PB	100
A57CB	A57CBP	Chrome trim ring	20
BK5557GB	BK5557GBP	Cam-on mounting bracket	50

<b>FMVSS</b>	A P2
<b>MATERIALS</b>	Polycarbonate lens and housing
<b>VOLT/AMP</b>	12.8VDC - 0.047A
<b>WT/DIMS</b>	.088 lbs. / 2.5" x 2.5" x 1.063"
<b>WARRANTY</b>	Lifetime LED Warranty

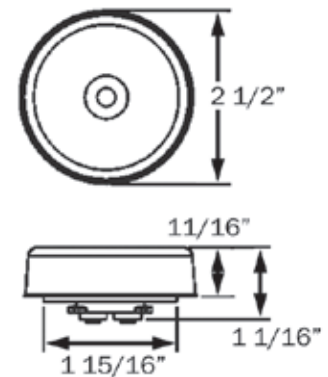

HOLE CUT-OUT: 2.75"

SEALED LED MARKER/  
CLEARANCE LIGHTS



## MCL190 SERIES GloLight® Mini Thinline Sealed LED Marker/Clearance Lights



MCL190AB



MCL190RB

### PATENTED TECHNOLOGY

- Sonically sealed, waterproof
- Hard wired with female PL-10 plug on 5" leads
- Includes both lead and ground wire for mounting to all surfaces

BULK P/N	POLYPACK P/N	DESCRIPTION	QTY
<b>YELLOW - 8 DIODES</b>			
MCL190AB	MCL190ABP	Kit with chrome base, female PL-10 plug	50
<b>RED - 8 DIODES</b>			
MCL190RB	MCL190RBP	Kit with chrome base, female PL-10 plug	50

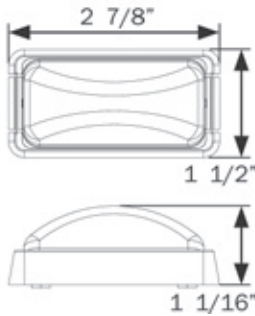

FMVSS	P2
MATERIALS	Polycarbonate lens and housing
VOLT/AMP	12.8VDC - 0.16A
WT/DIMS	.044 lbs. / 2.625" x 1.25" x .875"
WARRANTY	Lifetime LED Warranty



## AL91 SERIES Mini Thinline Sealed LED Marker/Clearance Lights



- Sonically sealed, waterproof
- Standard models accept standard 1- or 2-wire plugs
- Hard wired design available in 1- and 2-wire models
- Single wire design grounds through mounting hardware
- Two-wire design includes both lead and ground wire for mounting to all surfaces
- PC rated light functions as both clearance and side marker light when properly mounted on a 45 degree angle

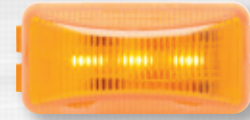

AL91AB



AL91RB

BULK P/N	POLYPACK P/N	DESCRIPTION	QTY
<b>YELLOW - 3 DIODES</b>			
AL91AB	AL91ABP	PC rated	50
AL91CAB	AL91CABP	PC rated, clear lens	50
MCL91AB	MCL91ABP	Kit: AL91AB, A91CB & A91LW	50
AL82AB	AL82ABP	PC rated, hard wired, 2-wire	50
MCL96AB	MCL96ABP	P2 rated kit, hard wired, 1-wire, A91BB base	50
<b>RED - 3 DIODES</b>			
AL91RB	AL91RBP	PC rated	50
MCL91RB	MCL91RBP	Kit: AL91RB, A91CB & A91LW	50
AL82RB	AL82RBP	PC rated, hard wired, 2-wire	50
MCL96RB	MCL96RBP	P2 rated kit, hard wired, 1-wire, A91BB base	50
<b>ACCESSORIES</b>			
A46PB	A46PBP	2-wire PL-10 plug, 6" lead	100
A86PB	A86PBP	2-wire PL-10 plug, 18" lead	100
A91LW	A91LWP	1-wire plug, 12" lead	100
A91BB	A91BBP	Black base, self grounding	100
A91BOB	A91BOBP	Black base, open back	100
A91CB	A91CBP	Chrome base, self grounding	100
A91OB	A91OBP	Chrome base, open back	100
A91GB	A91GBP	Grommet	100
<b>RETAIL</b>			
MCL91AK		Yellow P2 kit with A91CB & A91LW, clam	12
MCL90AS		Yellow P2 light only, clam	12
MCL91RK		Red P2 kit with A91CB & A91LW, clam	12
MCL90RS		Red P2 light only, clam	12

<b>FMVSS</b>	PC (unless noted)
<b>MATERIALS</b>	Polycarbonate lens and housing
<b>VOLT/AMP</b>	12.8VDC - 0.051A
<b>WT/DIMS</b>	.088 lbs. 2.5" x 1.25" x 1"
<b>WARRANTY</b>	Lifetime LED Warranty

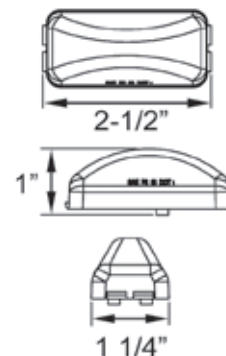

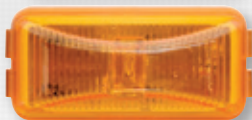
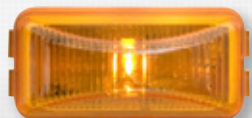

AL90AB



AL90RB

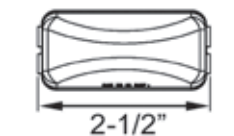

## AL90 SERIES

### FLEET Count™ Mini Thinline Sealed LED Marker/Clearance Light

- Sonically sealed, waterproof
- Accept standard 1- or 2-wire plugs
- Single wire design grounds through mounting hardware
- Two-wire design includes both lead and ground wire for mounting to all surfaces

BULK P/N	POLYPACK P/N	DESCRIPTION	QTY
<b>YELLOW - 1 DIODE</b>			
AL90AB	AL90ABP	Light only	50
<b>RED - 1 DIODE</b>			
AL90RB	AL90RBP	Light only	50
AL90RCB	AL90RCBP	Clear lens, red diode, light only	50
<b>ACCESSORIES</b>			
A46PB	A46PBP	2-wire PL-10 plug, 6" lead	100
A86PB	A86PBP	2-wire PL-10 plug, 18" lead	100
A91LW	A91LWP	1-wire plug, 12" lead	100
A91BB	A91BBP	Black base, self grounding	100
A91BOB	A91BOBP	Black base, open back	100
A91CB	A91CBP	Chrome base, self grounding	100
A91OB	A91OBP	Chrome base, open back	100
A91GB	A91GBP	Grommet	100
<b>RETAIL</b>			
AL90AK		Yellow kit with A91BB & A91LW, clam	12
AL90AS		Yellow light only, clam	12
AL90RK		Red kit with A91BB & A91LW, clam	12
AL90RS		Red light only, clam	12

FMVSS	P2
MATERIALS	Polycarbonate lens and housing
VOLT/AMP	12.8VDC - 0.023A
WT/DIMS	.044 lbs. / 2.5" x 1.25" x 1"
WARRANTY	Lifetime LED Warranty

## MCL165 SERIES GloLight® Thinline Sealed LED Marker/Clearance Lights

**GloLight®**

SEALED LED MARKER/  
CLEARANCE LIGHTS

### PATENTED TECHNOLOGY

- Sonically sealed, waterproof
- Accept standard 1- or 2-wire plugs
- Single wire design grounds through mounting hardware
- Two-wire design includes both lead and ground wire for mounting to all surfaces

BULK P/N	POLYPACK P/N	DESCRIPTION	QTY
<b>YELLOW - 10 DIODES</b>			
MCL165AB	MCL165ABP	Light only	20
<b>RED - 10 DIODES</b>			
MCL165RB	MCL165RBP	Light only	20
<b>ACCESSORIES</b>			
A65B	A65BP	Black bracket	50
A65P	A65PP	Single wire plug, .156 male bullet	50
A65PB	A65PBP	Kit: A65B black bracket & A65P plug	50
A66PB	A66PBP	Kit: Gray bracket & A65P plug	50
A67CB	A67CBP	Kit: Chrome bracket & A65P plug	50
A68PB	A68PBP	Kit: Black bracket & 2-wire plug	50

For more details on mounting and wiring accessories, see Accessories section at back of catalog.

<b>FMVSS</b>	P2
<b>MATERIALS</b>	Polycarbonate lens and housing
<b>VOLT/AMP</b>	12.8VDC - 0.07A
<b>WT/DIMS</b>	.066 lbs. / 3.875" x 1.25" x 1"
<b>WARRANTY</b>	Lifetime LED Warranty

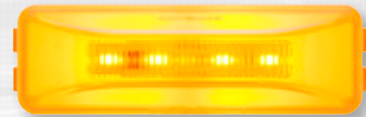

MCL165AB

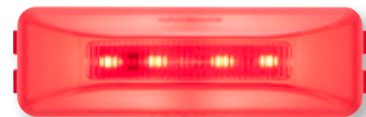

MCL165RB

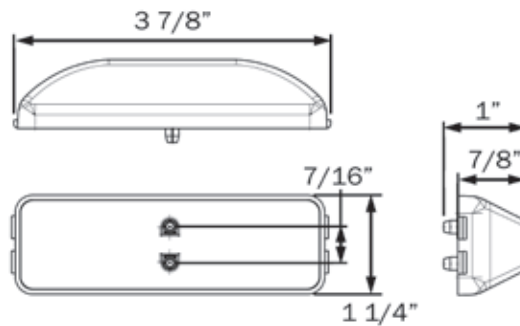



## MCL65 SERIES Thinline Sealed LED Marker/Clearance Lights



MCL65AB



MCL65CAB



MCL65CRB



MCL65RB

- Sonically sealed, waterproof
- Accept standard 1- or 2-wire plugs
- Single wire design grounds through mounting hardware
- Two-wire design includes both lead and ground wire for mounting to all surfaces

BULK P/N	POLYPACK P/N	DESCRIPTION	QTY
<b>YELLOW</b>			
MCL65AB	MCL65ABP	12V, 3 diodes	20
MCL65A24B	MCL65A24BP	24V, 3 diodes	20
MCL65CAB	MCL65CABP	12V, 3 diodes, clear lens	20
MCL67AB	MCL67ABP	12V, 3 diodes, kit with A65PB	20
MCL75AB	MCL75ABP	12V, 4 diodes	20
MCL77AB	MCL77ABP	12V, 4 diodes, kit with A65PB	20
<b>RED</b>			
MCL65RB	MCL65RBP	12V, 3 diodes	20
MCL65R24B	MCL65R24BP	24V, 3 diodes	20
MCL65CRB	MCL65CRBP	12V, 3 diodes, clear lens	20
MCL67RB	MCL67RBP	12V, 3 diodes, kit with A65PB	20
MCL75RB	MCL75RBP	12V, 4 diodes	20
MCL77RB	MCL77RBP	12V, 4 diodes, kit with A65PB	20
<b>ACCESSORIES</b>			
A65B	A65BP	Black bracket	50
A65P	A65PP	Single wire plug, .156 male bullet	50
A65PB	A65PBP	Kit: A65B black bracket & A65P plug	50
A66PB	A66PBP	Kit: Gray bracket & A65P plug	50
A67CB	A67CBP	Kit: Chrome bracket & A65P plug	50
A68PB	A68PBP	Kit: Black bracket & 2-wire plug	50

For more details on mounting and wiring accessories, see Accessories section at back of catalog.

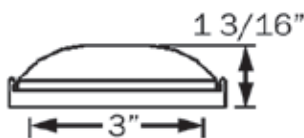
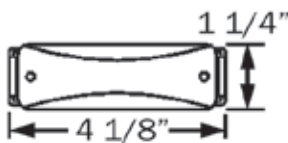

FMVSS	P2
MATERIALS	Polycarbonate lens and housing
VOLT/AMP	12.8VDC - 0.048A
WT/DIMS	.066 lbs. / 3.938" x 1.25" x 1.25"
WARRANTY	Lifetime LED Warranty

## MCL61 SERIES

### FLEET Count™ Thinline Sealed LED Marker/Clearance Lights

- Sonically sealed, waterproof
- Accept standard 1- or 2-wire plugs
- Single wire design grounds through mounting hardware
- Two-wire design includes both lead and ground wire for mounting to all surfaces



SEALED LED MARKER/  
CLEARANCE LIGHTS

BULK P/N	POLYPACK P/N	DESCRIPTION	QTY
<b>YELLOW - 2 DIODES</b>			
MCL61AB	MCL61ABP	Light only	20
<b>RED - 2 DIODES</b>			
MCL61RB	MCL61RBP	Light only	20
<b>ACCESSORIES</b>			
A65B	A65BP	Black bracket	50
A65P	A65PP	Single wire plug, .156 male bullet	50
A65PB	A65PBP	Kit: A65B black bracket & A65P plug	50
A66PB	A66PBP	Kit: Gray bracket & A65P plug	50
A67CB	A67CBP	Kit: Chrome bracket & A65P plug	50
A68PB	A68PBP	Kit: Black bracket & 2-wire plug	50
For more details on mounting and wiring accessories, see Accessories section at back of catalog.			
<b>RETAIL</b>			
MCL61AK		Yellow kit with A65PB, clam	12
MCL61AS		Yellow light only, clam	12
MCL61RK		Red kit with A65PB, clam	12
MCL61RS		Red light only, clam	12

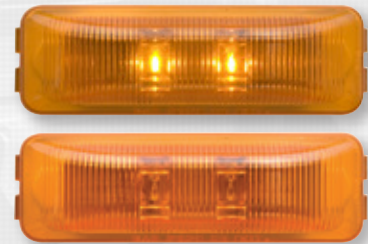

MCL61AB



MCL61RB

FMVSS	P2
MATERIALS	Polycarbonate lens and housing
VOLT/AMP	12.8VDC - 0.051A
WT/DIMS	.066 lbs. / 4" x 1.25" x 1"
WARRANTY	Lifetime LED Warranty

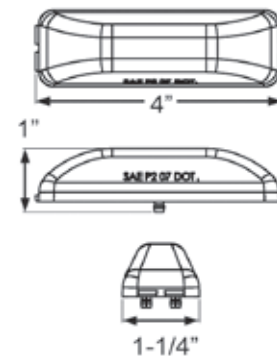



## MCL63 SERIES

### Miro-Flex™ Thinline Sealed LED Marker/Clearance Lights



MCL63AB



MCL63CAB



MCL63CRB



MCL63RB

- Sonically sealed, waterproof
- Accept standard 1- or 2-wire plugs
- Single wire design grounds through mounting hardware
- Two-wire design includes both lead and ground wire for mounting to all surfaces

BULK P/N	POLYPACK P/N	DESCRIPTION	QTY
<b>YELLOW - 4 DIODES</b>			
MCL63AB	MCL63ABP	Light only	20
MCL63CAB	MCL63CABP	Light only, clear lens	20
<b>RED - 4 DIODES</b>			
MCL63RB	MCL63RBP	Light only	20
MCL63CRB	MCL63CRBP	Light only, clear lens	20
<b>ACCESSORIES</b>			
A65B	A65BP	Black bracket	50
A65P	A65PP	Single wire plug, .156 male bullet	50
A65PB	A65PBP	Kit: A65B black bracket & A65P plug	50
A66PB	A66PBP	Kit: Gray bracket & A65P plug	50
A67CB	A67CBP	Kit: Chrome bracket & A65P plug	50
A68PB	A68PBP	Kit: Black bracket & 2-wire plug	50

For more details on mounting and wiring accessories, see Accessories section at back of catalog.

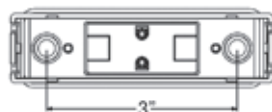
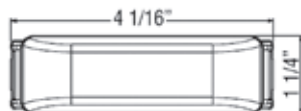

<b>FMVSS</b>	P2
<b>MATERIALS</b>	Polycarbonate lens and housing
<b>VOLT/AMP</b>	12.8VDC - 0.051A
<b>WT/DIMS</b>	.066 lbs. / 4" x 1.25" x 1"
<b>WARRANTY</b>	Lifetime LED Warranty

## MCL61/65 SERIES

### Thinline Sealed LED Fender Lights

- Sonically sealed, waterproof
- Accept standard 1- or 2-wire plugs
- Single wire design grounds through mounting hardware
- Two-wire design includes both lead and ground wire for mounting to all surfaces

BULK P/N	POLYPACK P/N	DESCRIPTION	QTY
<b>DUAL RED/YELLOW - 10 DIODES</b>			
MCL65ARB	MCL65ARBP	Light only	20
MCL65CARB	MCL65CARBP	Light only, clear lens	20
MCL67ARB	MCL67ARBP	Kit with A65PB bracket & plug	20
<b>DUAL RED/YELLOW - 2 DIODES</b>			
MCL61ARB	MCL61ARBP	Light only	20
MCL61AR26BK	MCL61AR26BKP	Kit with A67BB black base & 26" power wire with .150 male bullet	20
<b>ACCESSORIES</b>			
A67BB	A67BBP	Black fender bracket	50
A67GB	A67GBP	Gray fender bracket	50
A67CVB	A67CVBP	Curved fender bracket, gray	50
A65B	A65BP	Black bracket	50
A65P	A65PP	Single wire plug, .156 male bullet	50
A65PB	A65PBP	Kit: A65B black bracket & A65P plug	50
A66PB	A66PBP	Kit: Gray bracket & A65P plug	50
A67CB	A67CBP	Kit: Chrome bracket & A65P plug	50
A68PB	A68PBP	Kit: Black bracket & 2-wire plug	50

For more details on mounting and wiring accessories, see Accessories section at back of catalog.

<b>FMVSS</b>	P2
<b>MATERIALS</b>	Polycarbonate lens and housing
<b>VOLT/AMP</b>	12.8VDC - 0.048A
<b>WT/DIMS</b>	.066 lbs. / 3.875" x 1.25" x 0.875"
<b>WARRANTY</b>	Lifetime LED Warranty

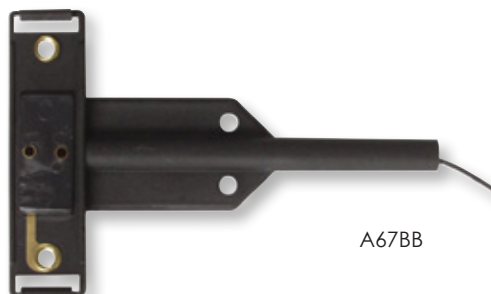

A67BB

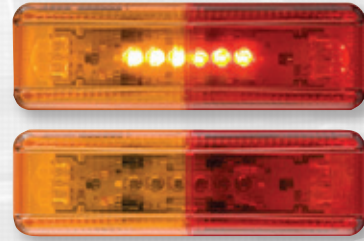

MCL65ARB



MCL61ARB

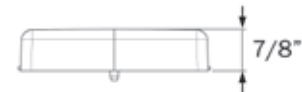

light only

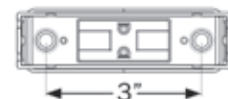

light with base

SEALED LED MARKER/  
CLEARANCE LIGHTS



## MCL180 SERIES LED Fender Light Assembly



- Reversible - one product can be used for either driver or passenger side of trailer
- Sonically sealed, waterproof
- P2 rated
- Hard wired, includes separate ground wire

BULK P/N	POLYPACK P/N	DESCRIPTION	QTY
<b>FENDER LIGHT - 2 DIODES</b>			
MCL180ARB	MCL180ARBP	Amber/red, reversible	50

FMVSS	P2
MATERIALS	Polycarbonate lens and housing
VOLT/AMP	12.8VDC - .033A
WT/DIMS	.05 lbs. / 8.50" x 1.688" x .813"
WARRANTY	Lifetime LED Warranty

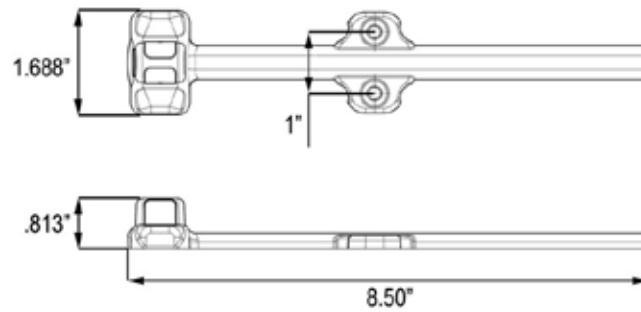



## MCL99 SERIES

### Mini Sealed LED Horizontal-Vertical Marker/Clearance Lights

- Sealed, waterproof design
- Surface mount installation at either horizontal or vertical
- Single wire design grounds through mounting hardware
- Two-wire design includes both lead and ground wire for mounting to all surfaces



SURFACE MOUNT LED MARKER/CLEARANCE LIGHTS



MCL99AB/A1B



MCL99RB/R1B



MCL99AC1B



MCL99RC1B

BULK P/N	POLYPACK P/N	DESCRIPTION	QTY
<b>YELLOW - 1 DIODE</b>			
MCL99AB	MCL99ABP	2-wire	20
MCL99A1B	MCL99A1BP	Single wire, self-grounding	20
MCL99AC1B	MCL99AC1BP	Clear lens, single wire, self-grounding	50
<b>RED - 1 DIODE</b>			
MCL99RB	MCL99RBP	2-wire	20
MCL99R1B	MCL99R1BP	Single wire, self grounding	20
MCL99RC1B	MCL99RC1BP	Clear lens, single wire, self-grounding	50

<b>FMVSS</b>	P2
<b>MATERIALS</b>	Polycarbonate lens and housing
<b>VOLT/AMP</b>	12.8VDC - .06A
<b>WT/DIMS</b>	.088 lbs. / 2.5" x 1.125" x 0.625"
<b>WARRANTY</b>	Lifetime LED Warranty

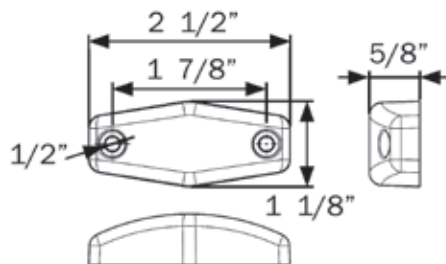



## MCL13 SERIES Mini Sealed LED Marker/Clearance Lights



MCL13A2B



MCL13CA2B



MCL13CR2B



MCL13R2B



MCL13CA3B



MCL13CR3B

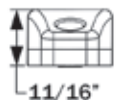

- Sonically sealed, waterproof
- Surface mount installation
- Single wire design grounds through mounting hardware
- Two-wire design includes both lead and ground wire for mounting to all surfaces
- Available in red, yellow, and clear utility light

BULK P/N	POLYPACK P/N	DESCRIPTION	QTY
<b>YELLOW - 2 DIODES</b>			
MCL13A2B	MCL13A2BP	2-wire	20
MCL13CA2B	MCL13CA2BP	2-wire, clear lens	20
MCL13CA3B	MCL13CA3BP	2-wire, clear lens, no base	50
MCL13A2MB	MCL13A2MBP	2-wire, .156 male bullets	20
MCL13APG	MCL13APGP	2-wire, 12" leads, .156 male bullets	20
MCL13A2PG	MCL13A2PGP	2-wire, .180 male bullets	20
MCL131A2B	MCL131A2BP	1-wire	20
MCL131CA2B	MCL131CA2BP	1-wire, clear lens	20
<b>RED - 2 DIODES</b>			
MCL13R2B	MCL13R2BP	2-wire	20
MCL13CR2B	MCL13CR2BP	2-wire, clear lens	20
MCL13CR3B	MCL13CR3BP	2-wire, clear lens, no base	50
MCL13R2MB	MCL13R2MBP	2-wire, .156 male bullets	20
MCL13R2PG	MCL13R2PGP	2-wire, .180 male bullets	20
MCL131R2B	MCL131R2BP	1-wire	20
MCL131CR2B	MCL131CR2BP	1-wire, clear lens	20
<b>UTILITY LIGHTS - 2 DIODES</b>			
UCL13C2PG	UCL13C2PGP	White LED 2-wire, .180 female barrels	20
<b>ACCESSORIES</b>			
A13C2B	A13C2BP	Chrome base/bezel	100
A13B2B	A13B2BP	Black base/bezel	100
A13G2B	A13G2BP	Gasket	200
<b>RETAIL</b>			
MCL13ATRS		Yellow, 2-wire, chrome bezel	12
MCL13AS		Yellow 2-wire light only	12
MCL13RTRS		Red, 2-wire, chrome bezel	12
MCL13RS		Red 2-wire light only	12
<b>FMVSS</b>	P2 P3 (except UCL13)		
<b>MATERIALS</b>	Polycarbonate lens and housing		
<b>VOLT/AMP</b>	12.8VDC - 0.046A		
<b>WT/DIMS</b>	.088 lbs. / 2.5" x 1.063" x 0.688" (models with no base .625" H)		
<b>WARRANTY</b>	Lifetime LED Warranty		

## MCL14 SERIES

### Mini Sealed LED Horizontal-Vertical Marker/Clearance Lights



- Sonically sealed, waterproof
- Surface mount installation at either horizontal or vertical
- Single wire design grounds through mounting hardware
- Two-wire design includes both lead and ground wire for mounting to all surfaces
- Available in red, yellow, and clear lens



MCL14AB

MCL14CABF



MCL14CRBF



MCL14 clear lens, unlit



MCL14RB

BULK P/N	POLYPACK P/N	DESCRIPTION	QTY
<b>YELLOW - 3 DIODES</b>			
MCL14AB	MCL14ABP	2-wire	20
MCL14ABF	MCL14ABFP	2-wire, female plug	20
MCL14AGB	MCL14AGBP	1-wire, self grounding	20
MCL14AGPB	MCL14AGPBP	1-wire, .180 male bullet	20
MCL14CABF	MCL14CABFP	Clear lens, 2-wire, .156 female barrels	20
MCL14A12GB	MCL14A12GBP	1-wire, 12" lead	20
<b>RED - 3 DIODES</b>			
MCL14RB	MCL14RBP	2-wire	20
MCL14RBF	MCL14RBF	2-wire, female plug	20
MCL14RGB	MCL14RGBP	1-wire, self grounding	20
MCL14CRBF	MCL14CRBFP	Clear lens, 2-wire, .156 female barrels	20
MCL14RPG	MCL14RPGP	2-wire, 12" leads, .156 male bullets	20
<b>ACCESSORIES</b>			
A13C2B	A13C2BP	Chrome base/bezel	100
A13B2B	A13B2BP	Black base/bezel	100
A13G2B	A13G2BP	Gasket	200

FMVSS	P2 PC
MATERIALS	Polycarbonate lens and housing
VOLT/AMP	12.8VDC - 0.06A
WT/DIMS	.088 lbs. / 2.5" x 1.125" x 0.625"
WARRANTY	Lifetime LED Warranty



A13C2B

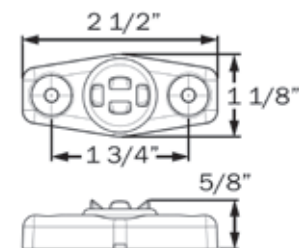



## MCL15 SERIES Surface Mount LED Marker/Clearance Lights



MCL15APG



MCL15AKPG



MCL15RPG



MCL15RKPG

- Sonically sealed, waterproof
- Surface mount installation
- Hard wired, includes both lead and ground wire with molded .180 male bullets
- Chrome finish ABS trim ring included with kits

BULK P/N	POLYPACK P/N	DESCRIPTION	QTY
<b>YELLOW - 2 DIODES</b>			
MCL15APG	MCL15APGP	Light only, .180 male bullets	20
MCL15AKPG	MCL15AKPGP	Kit: MCL15APG, chrome trim ring	20
<b>RED - 2 DIODES</b>			
MCL15RPG	MCL15RPGP	Light only, .180 male bullets	20
MCL15RKPG	MCL15RKPGP	Kit: MCL15RPG, chrome trim ring	20
<b>ACCESSORIES</b>			
A15CB	A15CBP	Chrome base/bezel	100
A15BB	A15BBP	Black base/bezel	100
A15GB	A15GBP	Gasket	50

<b>FMVSS</b>	P2
<b>MATERIALS</b>	Polycarbonate lens and housing, ABS trim ring
<b>VOLT/AMP</b>	12.8VDC - 0.047A
<b>WT/DIMS</b>	Light: .088 lbs. / 2.625" x 1.375" x .563" Kit: .092 lbs. / 3.938" x 1.344" x .688"
<b>WARRANTY</b>	Lifetime LED Warranty

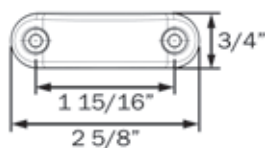

MCL15APG/RPG

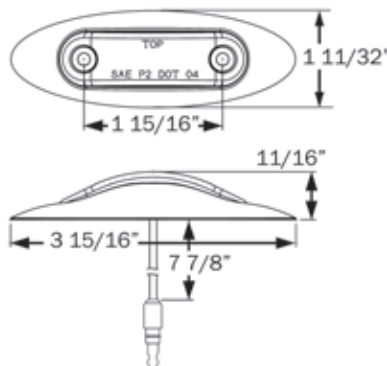

MCL15AKPG/RKPG

## MCL299 SERIES

### Sealed LED Marker/Clearance Light

- Sonically sealed, waterproof
- Adhesive mount
- Hard wired, includes separate ground wire



MCL299AB



MCL299RB

BULK P/N	POLYPACK P/N	DESCRIPTION	QTY
<b>YELLOW - 1 DIODE</b>			
MCL299AB	MCL299ABP	Light only	50
<b>RED - 1 DIODE</b>			
MCL299RB	MCL299RBP	Light only	50

<b>FMVSS</b>	PC
<b>MATERIALS</b>	Polycarbonate lens and housing
<b>VOLT/AMP</b>	Yellow: 12.8VDC - 0.12A Red: 12.8V - 0.065A
<b>WT/DIMS</b>	.03 lbs. / 1.50" x .625" x .75"
<b>WARRANTY</b>	Lifetime LED Warranty

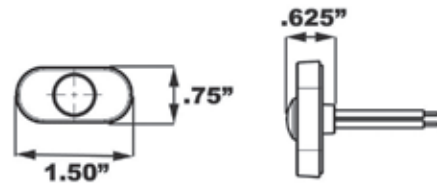



## MCL17/19 SERIES

### Miro-Flex™ Surface Mount Sealed LED Marker/Clearance Lights

- Sonically sealed, waterproof
- Two-wire design includes both lead and ground wire for mounting to all surfaces
- Snap-on chrome trim ring included
- Available in 3-LED 4" model and 4-LED 6" model



MCL17AB



MCL17CAB/CRB



MCL17RB



MCL19AB



MCL19CAB/CRB



MCL19RB



A17GB

BULK P/N	POLYPACK P/N	DESCRIPTION	QTY
<b>YELLOW</b>			
MCL17AB	MCL17ABP	3-LED	20
MCL17APG	MCL17APGP	3-LED, female PL-10 plug	20
MCL17CAB	MCL17CABP	3-LED, clear lens	20
MCL19AB	MCL19ABP	4-LED	20
MCL19CAB	MCL19CABP	4-LED, clear lens	20
<b>RED</b>			
MCL17RB	MCL17RBP	3-LED	20
MCL17RPG	MCL17RPGP	3-LED, female PL-10 plug	20
MCL17CRB	MCL17CRBP	3-LED, clear lens	20
MCL19RB	MCL19RBP	4-LED	20
MCL19CRB	MCL19CRBP	4-LED, clear lens	20
<b>ACCESSORIES</b>			
A17GB	A17GBP	Black gasket for 3-LED models	100

<b>FMVSS</b>	P2
<b>MATERIALS</b>	Polycarbonate lens and housing
<b>VOLT/AMP</b>	MCL17: 12.8VDC - 0.047A MCL19: 12.8VDC - 0.051A
<b>WT/DIMS</b>	MCL17: .088 lbs. / 4.188" x 1.375" x .75" MCL19: .132 lbs. / 5.75" x 1.563" x .75"
<b>WARRANTY</b>	Lifetime LED Warranty

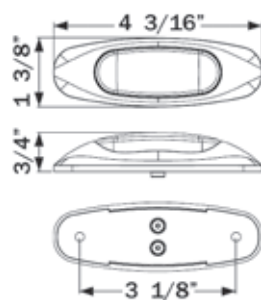

MCL17

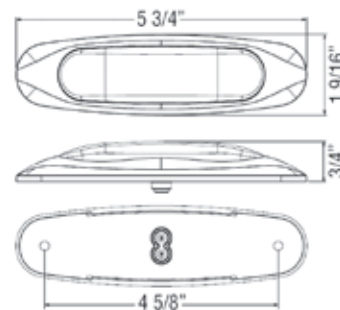

MCL19

## MCL31 SERIES

### Surface Mount LED Marker/Clearance Lights with Reflex

- Snap-on, replaceable lens
- Lens with reflex eliminates need for separate reflector
- Two-wire design includes both lead and ground wire for mounting to all surfaces

BULK P/N	POLYPACK P/N	DESCRIPTION	QTY
<b>YELLOW - 6 DIODES</b>			
MCL31AB	MCL31ABP	Light only, white base	20
<b>RED - 6 DIODES</b>			
MCL31RB	MCL31RBP	Light only, white base	20
<b>FMVSS</b>	A P2		
<b>MATERIALS</b>	Acrylic lens, ABS housing		
<b>VOLT/AMP</b>	12.8VDC - 0.040A		
<b>WT/DIMS</b>	.132 lbs. / 4" x 2.063" x 1"		
<b>WARRANTY</b>	Lifetime LED Warranty		



MCL31RB

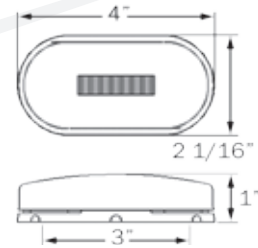

## MCL32 SERIES

### Surface Mount LED Marker/Clearance Lights with Reflex

- Snap-on, replaceable lens
- Lens with reflex eliminates need for separate reflector
- Two-wire design includes both lead and ground wire for mounting to all surfaces

BULK P/N	POLYPACK P/N	DESCRIPTION	QTY
<b>YELLOW - 3 DIODES</b>			
MCL32AB	MCL32ABP	Light only, white base	100
MCL32ABB	MCL32ABBP	Light only, black base	100
<b>RED - 3 DIODES</b>			
MCL32RB	MCL32RBP	Light only, white base	100
MCL32RBB	MCL32RBBP	Light only, black base	100
<b>RETAIL</b>			
MCL32AS		Yellow light with white base	12
MCL32ABS		Yellow light with black base	12
MCL32RS		Red light with white base	12
MCL32RBS		Red light with black base	12

<b>FMVSS</b>	A P2		
<b>MATERIALS</b>	Acrylic lens, ABS housing		
<b>VOLT/AMP</b>	12.8VDC - 0.2A		
<b>WT/DIMS</b>	.132 lbs. / 4" x 2" x 1"		
<b>WARRANTY</b>	Lifetime LED Warranty		



MCL32AB



MCL32RB





## MCL35A32G

### Surface Mount LED Marker/ Clearance Light with Reflex

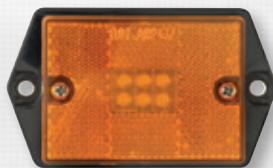

MCL35A32G

- Surface mount black base, mounts on 3-5/16" centers
- Lens with reflex eliminates need for separate reflector
- Self grounding; 32" power wire with .180 male bullet

BULK P/N	POLYPACK P/N	DESCRIPTION	QTY
<b>YELLOW - 6 DIODES</b>			
MCL35A32G	MCL35A32GP	Light, 32" lead with .180 male bullet	50

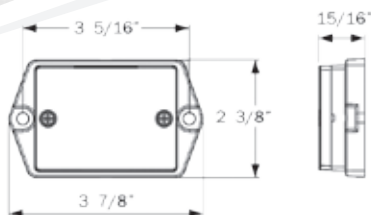

FMVSS	A P2
MATERIALS	Acrylic lens, ABS housing
VOLT/AMP	12.8VDC - 0.165A
WT/DIMS	.110 lbs. / 3.875" x 2.375" x 0.938"
WARRANTY	Lifetime LED Warranty



## MCL36 SERIES

### Stud Mount LED Marker/ Clearance Light with Reflex

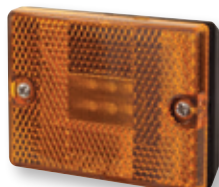

MCL36AB



MCL36RB

- Stud mount black base; two-wire design
- Lens with reflex eliminates need for separate reflector

BULK P/N	POLYPACK P/N	DESCRIPTION	QTY
<b>YELLOW - 6 DIODES</b>			
MCL36AB	MCL36ABP	Hard wired	20
MCL36APG	MCL36APGP	Hard wired, .180 male bullets	20
<b>RED - 6 DIODES</b>			
MCL36RB	MCL36RBP	Hard wired	20
<b>RETAIL</b>			
MCL36AS		Yellow light with hardware, clam	12

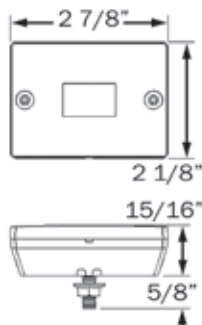

FMVSS	A P2
MATERIALS	Acrylic lens, ABS housing
VOLT/AMP	12.8VDC - 0.054A
WT/DIMS	.110 lbs. / 2.875" x 2.125" x .938"
WARRANTY	Lifetime LED Warranty



## MCL40/44 SERIES Surface Mount LED Marker/ Clearance Lights with Reflex

- Select from 2-LED and 6-LED models in amber and red
- Snap-on, replaceable lens
- Surface mount white base, mounts on 3" centers
- Lens with reflex eliminates need for separate reflector
- Single wire and two-wire designs available



SURFACE MOUNT LED  
MARKER/CLEARANCE LIGHTS

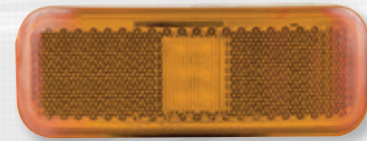

MCL40/44AB



MCL40/44RB

BULK P/N	POLYPACK P/N	DESCRIPTION	QTY
<b>YELLOW</b>			
MCL40AB	MCL40ABP	2-LED, 2-wire, power and ground	20
MCL40AB1	MCL40AB1P	2-LED, 1-wire, self grounding	20
MCL40APB	MCL40APBP	2-LED, 2-wire .180 male bullets	20
MCL44AB	MCL44ABP	6-LED, 2-wire, power and ground	20
MCL44AB1	MCL44AB1P	6-LED, 1-wire, self grounding	20
<b>RED</b>			
MCL40RB	MCL40RBP	2-LED, 2-wire, power and ground	20
MCL40RB1	MCL40RB1P	2-LED, 1-wire, self grounding	20
MCL44RB	MCL44RBP	6-LED, 2-wire, power and ground	20
MCL44RB1	MCL44RB1P	6-LED, 1-wire, self grounding	20
<b>ACCESSORIES</b>			
A44GTB	-	Mounting gasket, white	1000
<b>RETAIL</b>			
MCL40AS		2-LED, 2-wire, yellow, clam	12
MCL40RS		2-LED, 2-wire, red, clam	12

FMVSS	P2 A
MATERIALS	Acrylic lens, ABS housing
VOLT/AMP	12.8VDC - 2-LED 0.040A; 6-LED .054A
WT/DIMS	.088 lbs. / 4" x 1.5" x 0.938"
WARRANTY	Lifetime LED Warranty

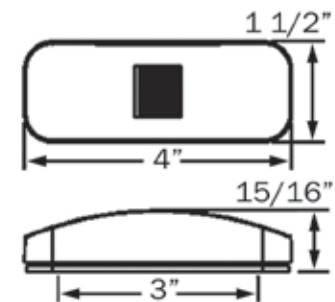



MCL45/46AB



MCL45/46RB

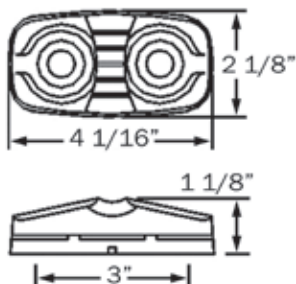

## MCL45/46 SERIES LED Double Bullseye Style Marker/Clearance Lights



- Snap-on, replaceable lens
- Surface mount white base, mounts on 3" centers
- Single wire and two-wire designs available

BULK P/N	POLYPACK P/N	DESCRIPTION	QTY
<b>YELLOW - 10 DIODES</b>			
MCL45AB	MCL45ABP	1-wire, self grounding	20
MCL46AB	MCL46ABP	2-wire, power and ground	20
<b>RED - 10 DIODES</b>			
MCL45RB	MCL45RBP	1-wire, self grounding	20
MCL46RB	MCL46RBP	2-wire, power and ground	20
<b>ACCESSORIES</b>			
AL46AB	AL46ABP	Yellow replacement lens	50
AL46RB	AL46RBP	Red replacement lens	50

<b>FMVSS</b>	P2 PC
<b>MATERIALS</b>	Acrylic lens, ABS housing
<b>VOLT/AMP</b>	12.8VDC - 0.087A
<b>WT/DIMS</b>	.088 lbs. / 4.063" x 2.125" x 1.125"
<b>WARRANTY</b>	Lifetime LED Warranty

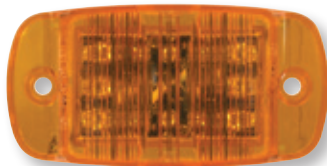

MCL49AB

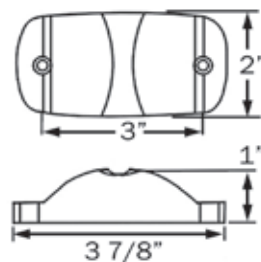

## MCL49AB Surface Mount Sealed LED Marker/Clearance Light



- Sonically sealed, waterproof
- Surface mount, mounts on 3" centers
- Includes both lead and ground wire

BULK P/N	POLYPACK P/N	DESCRIPTION	QTY
<b>YELLOW - 14 DIODES</b>			
MCL49AB	MCL49ABP	Light only	20
<b>FMVSS</b>	P2 PC		
<b>MATERIALS</b>	Polycarbonate lens and housing		
<b>VOLT/AMP</b>	12.8VDC - 0.87A		
<b>WT/DIMS</b>	.132 lbs. / 3.875" x 2" x 1"		
<b>WARRANTY</b>	Lifetime LED Warranty		

## MCL48 SERIES

### LED Intermediate Side Marker Light with Supplemental Mid-Ship Turn

- Sonically sealed, waterproof
- Surface mount, mounts on 4-13/16" centers
- Includes both lead and ground wires

BULK P/N	POLYPACK P/N	DESCRIPTION	QTY
<b>YELLOW - 16 DIODES</b>			
MCL48AB	MCL48ABP	Light	20
MCL48CAB	MCL48CABP	Light, clear lens	20
MCL48AKB	MCL48AKBP	Kit: MCL48AB with A48CB bezel	20
<b>ACCESSORIES</b>			
A48CB	A48CBP	Chrome bezel	50

<b>FMVSS</b>	P2
<b>MATERIALS</b>	Polycarbonate lens and housing
<b>VOLT/AMP</b>	12.8VDC - Side marker .074A; Turn signal .248A
<b>WT/DIMS</b>	.221 lbs. / 6" x 2.25" x 1.375"
<b>WARRANTY</b>	Lifetime LED Warranty



MCL48AB



MCL48CAB

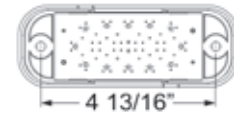
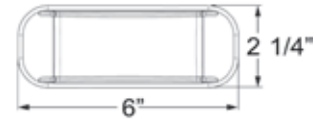

## MCL73 SERIES

### LED Surface Mount Marker/Clearance Lights



- Sonically sealed, waterproof
- Surface mount, mounts on 4-13/16" centers
- Includes both lead and ground wires

BULK P/N	POLYPACK P/N	DESCRIPTION	QTY
<b>YELLOW - 16 DIODES</b>			
MCL73AB	MCL73ABP	Light	20
<b>RED - 16 DIODES</b>			
MCL73RB	MCL73RBP	Light	20
<b>ACCESSORIES</b>			
A48CB	A48CBP	Chrome bezel	50

<b>FMVSS</b>	P2 PC
<b>MATERIALS</b>	Polycarbonate lens and housing
<b>VOLT/AMP</b>	12.8VDC - .248A
<b>WT/DIMS</b>	.221 lbs. / 6" x 2.25" x 1.375"
<b>WARRANTY</b>	Lifetime LED Warranty



MCL73AB

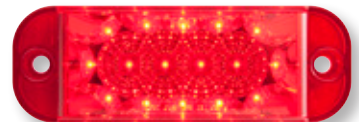

MCL73RB





MCL66AB

MCL66CAB



MCL66CRB



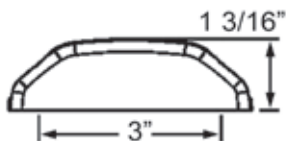

MCL66RB



## MCL66 SERIES

### Sealed LED Surface Mount Marker/Clearance Lights

- Select from 6-LED and 2-LED models in amber and red
- Sonically sealed, waterproof
- Surface mount, mounts on 3" centers
- Includes both lead and ground wire
- MCL166 series lights include a gasket and wire outlet grommet

BULK P/N	POLYPACK P/N	DESCRIPTION	QTY
<b>YELLOW</b>			
MCL66AB	MCL66ABP	6-LED, 12V	20
MCL66APG	MCL66APGP	6-LED, 12V, .180 male bullets	20
MCL66A24B	MCL66A24BP	6-LED, 12-24V	20
MCL66CAB	MCL66CABP	6-LED, 12V, clear lens	20
MCL166AB	MCL166ABP	2-LED, 12V with gasket	20
<b>RED</b>			
MCL66RB	MCL66RBP	6-LED, 12V	20
MCL66RPG	MCL66RPGP	6-LED, 12V, .180 male bullets	20
MCL66R24B	MCL66R24BP	6-LED, 12-24V	20
MCL66CRB	MCL66CRBP	6-LED, 12V, clear lens	20
MCL166RB	MCL166RBP	2-LED, 12V with gasket	20
<b>ACCESSORIES</b>			
A66GB	A66GBP	Gasket, black	100
BK66DB	BK66DBP	Heavy duty armored base, die cast metal	50
<b>RETAIL</b>			
MCL66AS		Yellow 6-LED, 12V, clam	12
MCL66RS		Red 6-LED, 12V, clam	12
<b>FMVSS</b>	P2		
<b>MATERIALS</b>	Polycarbonate lens and housing		
<b>VOLT/AMP</b>	12.8VDC - 0.057A		
<b>WT/DIMS</b>	.088 lbs. / 4" x .875" x 1.188"		
<b>WARRANTY</b>	Lifetime LED Warranty		

## MCL71 SERIES

### Low Profile LED Marker/ Clearance Light

- Chrome plated housing, replaceable lens
- Includes both lead and ground wire

BULK P/N	POLYPACK P/N	DESCRIPTION	QTY
<b>RED - 2 DIODES</b>			
MCL71RB	MCL71RBP	Flush mount marker light	20
<b>FMVSS</b>	P2		
<b>MATERIALS</b>	Acrylic lens, chrome plated ABS bezel		
<b>VOLT/AMP</b>	12.8VDC - 0.054A		
<b>WT/DIMS</b>	.088 lbs. / 3.75" x 2.25" x 1/2"		
<b>WARRANTY</b>	Lifetime LED Warranty		



MCL71RB

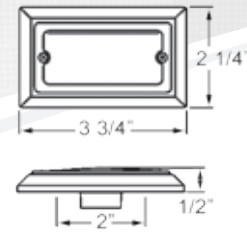

## MCL76 SERIES

### Sealed LED Surface Mount Marker/ Clearance Lights with Reflex

- Sonically sealed, waterproof
- Surface mount, mounts on 4-13/16" centers
- Lens with reflex eliminates need for a separate reflector
- Includes weathertight pigtail with both lead and ground wire

BULK P/N	POLYPACK P/N	DESCRIPTION	QTY
<b>YELLOW - 4 DIODES</b>			
MCL76AB	MCL76ABP	Light with reflex	20
<b>RED - 4 DIODES</b>			
MCL76RB	MCL76RBP	Light with reflex	20

<b>FMVSS</b>	A P2
<b>MATERIALS</b>	Polycarbonate lens and housing
<b>VOLT/AMP</b>	12.8VDC - 0.063A
<b>WT/DIMS</b>	.132 lbs. / 5.813" x 2" x 1.188"
<b>WARRANTY</b>	Lifetime LED Warranty



MCL76AB

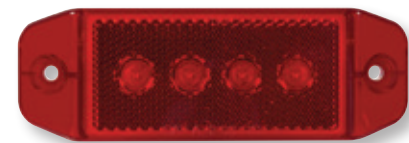

MCL76RB

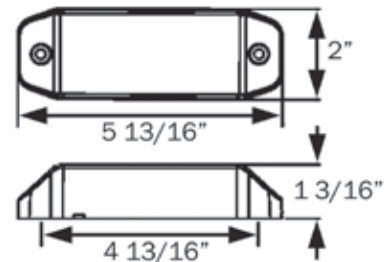



MCL85AB

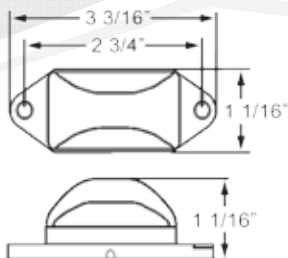

## MCL85 SERIES

### Sealed LED Surface Mount Amber Marker/Clearance Light

- Sonically sealed, waterproof
- Surface mount, mounts on 2-3/4" centers
- Single wire design grounds through mounting hardware

BULK P/N	POLYPACK P/N	DESCRIPTION	QTY
<b>YELLOW - 3 DIODES</b>			
MCL85AB	MCL85ABP	Surface mount light	50

FMVSS	P2 P3
MATERIALS	Polycarbonate lens and housing
VOLT/AMP	12.8VDC - 0.066A
WT/DIMS	.044 lbs. / 3.188" x 1.063" x 1.188"
WARRANTY	Lifetime LED Warranty



MCL81AB



MCL81RB

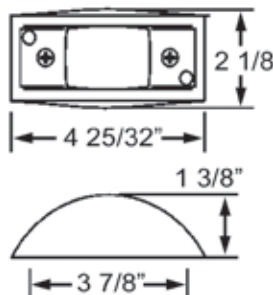

## MCL81 SERIES

### Chrome Plated LED Marker/Clearance Lights



- Chrome plated ABS housing
- Includes both lead and ground wire

BULK P/N	POLYPACK P/N	DESCRIPTION	QTY
<b>YELLOW - 6 DIODES</b>			
MCL81AB	MCL81ABP	Light with ABS housing	20
<b>RED - 6 DIODES</b>			
MCL81RB	MCL81RBP	Light with ABS housing	20

FMVSS	P2 PC
MATERIALS	Acrylic lens, chrome plated ABS bezel
VOLT/AMP	12.8VDC - 0.153A
WT/DIMS	.265 lbs. / 4.781" x 2.125" x 1.375"
WARRANTY	Lifetime LED Warranty

## MCL86 SERIES

### Armored Die Cast LED Marker/Clearance Lights



- Die cast steel housing, mounting gasket
- Surface mount, mounts on 3-7/8" centers
- Two-wire design with power and ground wires



BULK P/N	POLYPACK P/N	DESCRIPTION	QTY
<b>YELLOW - 6 DIODES</b>			
MCL86AB	MCL86ABP	Light with steel housing	20
<b>RED - 6 DIODES</b>			
MCL86RB	MCL86RBP	Light with steel housing	20

<b>FMVSS</b>	P2 PC
<b>MATERIALS</b>	Acrylic lens, steel housing
<b>VOLT/AMP</b>	12.8VDC - 0.20A
<b>WT/DIMS</b>	.463 lbs. / 4.5" x 2.25" x 1.5"
<b>WARRANTY</b>	Lifetime LED Warranty

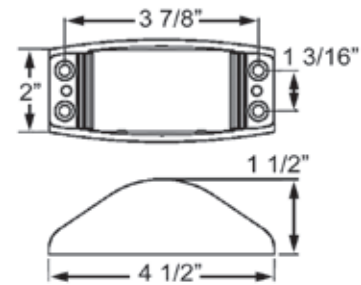

## MCL95 SERIES

### Sealed Stud Mount LED Marker/Clearance Lights



- Sonically sealed, waterproof
- Single wire design grounds through mounting hardware

BULK P/N	POLYPACK P/N	DESCRIPTION	QTY
<b>YELLOW - 3 DIODES</b>			
MCL95AB	MCL95ABP	1-wire, 20" lead	50
MCL95ABF	MCL95ABFP	2-wire, 5mm female barrels	50
<b>RED - 3 DIODES</b>			
MCL95RB	MCL95RBP	1-wire, 20" lead	50
MCL95RBF	MCL95RBF	2-wire, 5mm female barrels	50
<b>RETAIL</b>			
MCL95AS		Yellow, clam	12
MCL95RS		Red, clam	12

<b>FMVSS</b>	P2 P3
<b>MATERIALS</b>	Polycarbonate lens and housing, stainless steel base, plated steel stud
<b>VOLT/AMP</b>	12.8VDC - 0.051A
<b>WT/DIMS</b>	.088 lbs. / 2.125" x 1.125" x 1.063"
<b>WARRANTY</b>	Lifetime LED Warranty

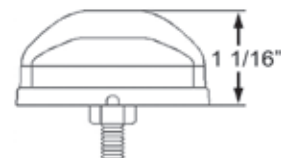
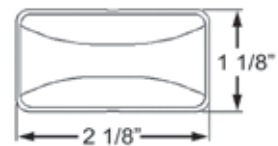



CBL22RB

CBL22AB

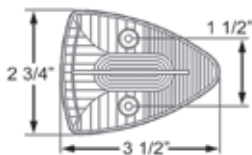

## CBL22 SERIES Sealed LED Triangular Cab/Clearance Light



- Sonically sealed, waterproof
- Design includes lead and ground wire
- Mounting gasket included

BULK P/N	POLYPACK P/N	DESCRIPTION	QTY
<b>YELLOW - 15 DIODES</b>			
CBL22AB	CBL22ABP	Cab light	50
CBL22CAB	CBL22CABP	Cab light, clear lens	50
<b>RED - 15 DIODES</b>			
CBL22RB	CBL22RBP	Cab light	50
<b>RETAIL</b>			
CBL22AS		Yellow cab light, clam	12

<b>FMVSS</b>	P2 PC
<b>MATERIALS</b>	Polycarbonate lens and housing
<b>VOLT/AMP</b>	12.8VDC - 0.107A
<b>WT/DIMS</b>	.176 lbs. / 3.5" x 2.75" x 1.688"
<b>WARRANTY</b>	Lifetime LED Warranty



## MCL70 SERIES

### Sealed LED Identification Light Bars for Over 80" Applications

- Sonically sealed, waterproof
- Ultra thin – only 5/8" thick
- Design includes both lead and ground wire



MCL70RB



MCL70RCB

BULK P/N	POLYPACK P/N	DESCRIPTION	QTY
<b>RED ID LIGHT BAR - 3 DIODES</b>			
MCL70RB	MCL70RBP	ID light bar	10
MCL70RBF2	MCL70RBF2P	ID light bar, .180 female barrels	10
MCL70RCB	MCL70RCBP	ID light bar, clear lens	10
<b>ACCESSORIES</b>			
A69CB	A69CBP	Chrome base/bezel	10
A69GB	A69GBP	Mounting gasket, black	10
<b>RETAIL</b>			
MCL70RS		Red, clam	20

FMVSS	P2
MATERIALS	Polycarbonate lens and housing
VOLT/AMP	12.8VDC - 0.038A
WT/DIMS	.441 lb. / 15" x 1.375" x .625"
WARRANTY	Lifetime LED Warranty



## MCL78/88 SERIES

### Sealed LED Identification Light Bars for Over 80" Applications

- Sonically sealed, waterproof
- Ultra thin – only 1" thick
- Design includes both lead and ground wire



MCL78RB



MCL88RCB

BULK P/N	POLYPACK P/N	DESCRIPTION	QTY
<b>RED ID LIGHT BAR - 3 DIODES</b>			
MCL78RB	MCL78RBP	ID light bar	10
MCL88RCB	MCL88RCBP	ID light bar, clear lens	10
<b>ACCESSORIES</b>			
A79CB	A79CBP	Chrome base/bezel	10

FMVSS	P2
MATERIALS	Polycarbonate lens and housing
VOLT/AMP	12.8VDC - 0.022A
WT/DIMS	.441 lb. / 17" x 1.375" x 1"
WARRANTY	Lifetime LED Warranty

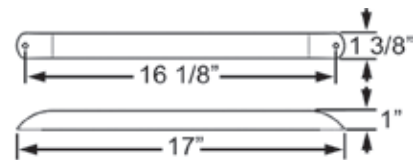



## MCL83 SERIES

### FLEET Count™ Sealed LED Identification Light Bar for Over 80" Applications

MCL83RB



MCL83RCB

- Sonically sealed, waterproof lights snap onto corrosion proof polycarbonate base
- Design includes both lead and ground wire

BULK P/N	POLYPACK P/N	DESCRIPTION	QTY
<b>RED ID LIGHT BAR - 3 DIODES</b>			
MCL83RB	MCL83RBP	3-LED ID light bar	10
MCL83RCB	MCL83RCBP	Clear lens, red diodes	10
AL90RB	AL90RBP	1-LED replacement light	50
<b>RETAIL</b>			
MCL83RK		3-LED ID light bar, slipover blister	6

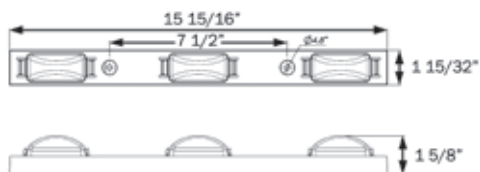

FMVSS	P2
MATERIALS	Polycarbonate lens and housing
VOLT/AMP	12.8VDC - .069A
WT/DIMS	.397 lb. / 15.938" x 1.469" x 1.625"
WARRANTY	Lifetime LED Warranty



## MCL93 SERIES

### Sealed LED Identification Light Bar for Over 80" Applications



MCL93RB

- Sonically sealed, waterproof lights snap onto corrosion proof polycarbonate base
- Design includes both lead and ground wire

BULK P/N	POLYPACK P/N	DESCRIPTION	QTY
<b>RED ID LIGHT BAR - 9 DIODES</b>			
MCL93RB	MCL93RBP	9-LED ID light bar	10
MCL93RPG	MCL93RPGP	9-LED ID light bar, .180 male bullet on power, eyelet on ground	10
AL91RB	AL91RBP	3-LED replacement light	50
<b>RETAIL</b>			
MCL93RK		9-LED ID light bar, slipover blister	6

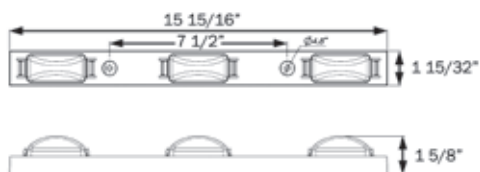

FMVSS	P2
MATERIALS	Polycarbonate lens and housing
VOLT/AMP	12.8VDC - 0.153A
WT/DIMS	.397 lb. / 15.938" x 1.469" x 1.625"
WARRANTY	Lifetime LED Warranty

## MCL84 SERIES

### Sealed LED Identification Light Bar for Over 80" Applications



- Sonically sealed, waterproof lights snap onto stainless steel base
- Design includes both lead and ground wire



MCL84RB

BULK P/N	POLYPACK P/N	DESCRIPTION	QTY
<b>RED ID LIGHT BAR - 9 DIODES</b>			
MCL84RB	MCL84RBP	9-LED ID light bar	10
AL91RB	AL91RBP	3-LED replacement light	50

<b>FMVSS</b>	P2
<b>MATERIALS</b>	Polycarbonate light, stainless steel housing
<b>VOLT/AMP</b>	12.8VDC - .153A
<b>WT/DIMS</b>	.397 lb. / 16.5" x 1.375" x 1.625"
<b>WARRANTY</b>	Lifetime LED Warranty

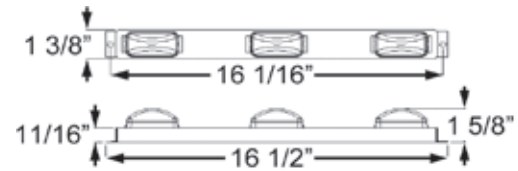

## MCL97 SERIES

### Sealed LED Identification Light Bar for Over 80" Applications



- Sealed, waterproof lights on stainless steel base
- Single wire, grounds through mounting hardware



MCL97RB

BULK P/N	POLYPACK P/N	DESCRIPTION	QTY
<b>RED ID LIGHT BAR - 9 DIODES</b>			
MCL97RB	MCL97RBP	9-LED ID light bar	10
MCL97RPG	MCL97RPGP	9-LED ID light bar, .180 male bullet	10

RETAIL			
MCL97RK		ID light bar, slipover blister	6

<b>FMVSS</b>	P2 P3
<b>MATERIALS</b>	Polycarbonate light, stainless steel base
<b>VOLT/AMP</b>	12.8VDC - .153A
<b>WT/DIMS</b>	.287 lb. / 14.25" x 1.188" x 1.313"
<b>WARRANTY</b>	Lifetime LED Warranty

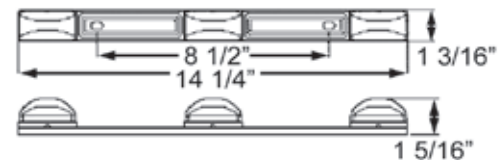



## MCL98 SERIES

### Sealed LED Identification Light Bar for Over 80" Applications

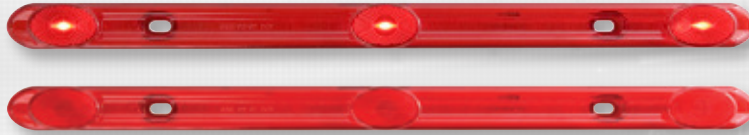

MCL98RB

- Sonically sealed, waterproof
- Compact – 14.25" x 1.125"
- Design includes both lead and ground wire

BULK P/N	POLYPACK P/N	DESCRIPTION	QTY
<b>RED ID LIGHT BAR - 3 DIODES</b>			
MCL98RB	MCL98RBP	ID light bar	10
<b>RETAIL</b>			
MCL98RK		Light bar, slipover blister	6

FMVSS	P2
MATERIALS	Polycarbonate lens and housing
VOLT/AMP	12.8VDC - 0.020A
WT/DIMS	.243 lb. / 14.25" x 1.125" x .875"
WARRANTY	Lifetime LED Warranty

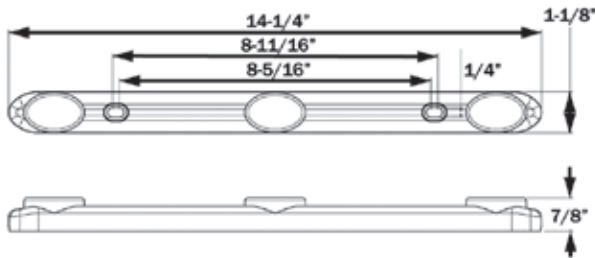

## MCL1922 SERIES

### GloLight® Sealed 3/4" LED Identification Lights for Over 80" Applications

**GloLight®**

PATENTED  
TECHNOLOGY

- Sonically sealed, waterproof
- Design includes both lead and ground wire



MCL1922RB

BULK P/N	POLYPACK P/N	DESCRIPTION	QTY
<b>RED ID LIGHTS - 3 DIODES</b>			
MCL1922RB	MCL1922RBP	ID light bar, molded black base	10
MCL112RB	MCL112RBP	GloLight® replacement light	50

<b>FMVSS</b>	P2
<b>MATERIALS</b>	Polycarbonate lens and housing
<b>VOLT/AMP</b>	12.8VDC - 0.022A
<b>WT/DIMS</b>	MCL922RB: .441 lb. / 14.875" x 1.25" x 1"
<b>WARRANTY</b>	Lifetime LED Warranty

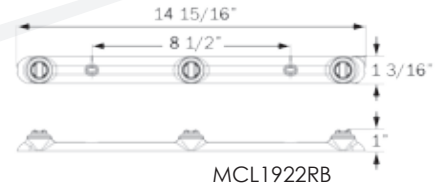

MCL1922RB

LED IDENTIFICATION  
LIGHT BARS

## MCL922 & MCL12/22 SERIES

### Sealed 3/4" LED Identification Lights for Over 80" Applications

**Optronics  
LED**

- Sonically sealed, waterproof
- Design includes both lead and ground wire



MCL922RB

BULK P/N	POLYPACK P/N	DESCRIPTION	QTY
<b>RED ID LIGHTS - 3 DIODES</b>			
MCL922RB	MCL922RBP	ID light bar, molded black base	10
MCL12RK3B	MCL12RK3BP	(3) red MCL12 lights, molded harness	20
MCL12RK3RMB	-	(3) red MCL12 lights, molded harness, weathertight plug	50
MCL22RK3B	-	(3) red MCL12 lights, molded harness, supplemental turn function	50
MCL22RK4B	-	(3) red MCL12 lights, supplemental turn function, amp connector	20
MCL12RB	MCL12RBP	Single diode replacement light	50



MCL12RK3B

<b>FMVSS</b>	P2
<b>MATERIALS</b>	Polycarbonate lens and housing
<b>VOLT/AMP</b>	12.8VDC - 0.022A
<b>WT/DIMS</b>	MCL922RB: .441 lb. / 14.875" x 1.25" x 1"
<b>WARRANTY</b>	Lifetime LED Warranty

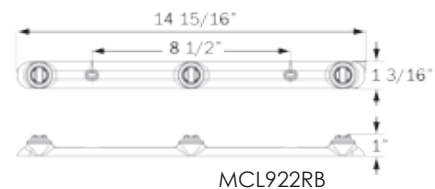

MCL922RB



## LPL11 SERIES Snap-In LED Mini License Plate Light

- Chrome-plated brass construction
- Easy snap-in mounting
- Sonically sealed, waterproof
- Two-wire design includes both lead and ground wire



BULK P/N	POLYPACK P/N	DESCRIPTION	QTY
<b>LICENSE LIGHT - 2 DIODES</b>			
LPL11CB	LPL11CBP	Snap-in, license light	50

FMVSS	(2) L
MATERIALS	Polycarbonate lens and brass housing
VOLT/AMP	12.8VDC - 0.14A
WT/DIMS	.068lbs. / 1.5" x 1.5" x 1.125"
WARRANTY	Lifetime LED Warranty



HOLE CUT-OUT: 1.25"

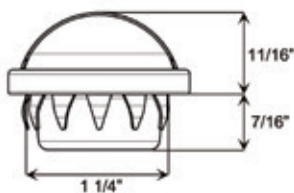

## LPL12 SERIES

### 3/4" Sealed LED License Light

- Sealed, waterproof
- Meets SAE J587 when properly mounted using brackets listed below
- Design includes both lead and ground wire



LPL12CB

BULK P/N	POLYPACK P/N	DESCRIPTION	QTY
<b>LICENSE LIGHT - 2 DIODES</b>			
LPL12CB	LPL12CBP	Light with .180 female barrels	20
LPL12CPGB	LPL12CPGBP	Light with .180 male bullets	20
LPL12CKM2B	LPL12CKM2BP	Kit: LPL12CPGB, A12B2LPB surface mount bracket, A12GLPB grommet	50
LPL12CKMB	LPL12CKMBP	Kit: LPL12CPGB with A11BLPB bracket	20
LPL12CKF2B	LPL12CKF2BP	Kit: LPL12CB, A12B2LPB surface mount bracket, A12GLPB grommet	50
LPL12CKM5B	LPL12CKM5BP	Kit: LPL12CPGB, A12B2LPB surface mount bracket with gasket, A12GLPB grommet	50
<b>ACCESSORIES</b>			
A11BLPB	A11BLPBP	Black flush mount bracket	50
A11GLPB	A11GLPBP	Gray flush mount bracket	50
A12B2LPB	A12B2LPBP	Black vertical mount bracket	50
A12GLPB	A12GLPBP	Grommet for A12B2LPB	50



Kit with A12B2LPB bracket



LPL12CKMB

<b>FMVSS</b>	L
<b>MATERIALS</b>	Polycarbonate lens and housing
<b>VOLT/AMP</b>	12.8VDC - 0.11A
<b>WT/DIMS</b>	.022 lb. / 0.74" x 0.74" x .938"
<b>WARRANTY</b>	Lifetime LED Warranty

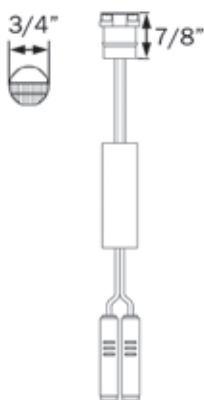

LPL12CB

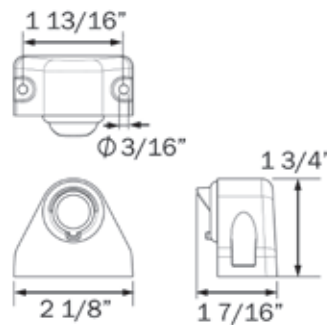

A12B2LPB

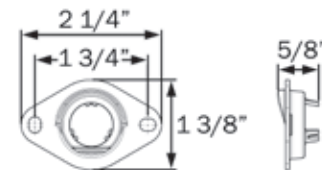

A11GLPB



LPL21CB

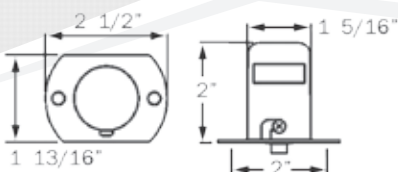

## LPL21 SERIES

### LED Heavy Duty License Plate Light

- Armored light made of durable, chrome plated steel
- Surface mount on 2" centers
- Design includes both lead and ground wire

BULK P/N	POLYPACK P/N	DESCRIPTION	QTY
<b>LICENSE LIGHT - 1 DIODE</b>			
LPL21CB	LPL21CBP	Armored license light	20

<b>FMVSS</b>	L
<b>MATERIALS</b>	Steel, polycarbonate lens
<b>VOLT/AMP</b>	12.8VDC - 0.054A
<b>WT/DIMS</b>	.132 lb. / 2.5" x 1.813" x 2"
<b>WARRANTY</b>	Lifetime LED Warranty



LPL31CB



LPL31CSB

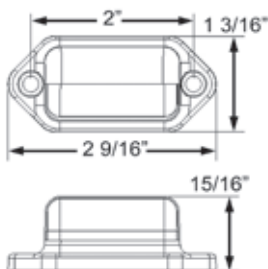

LPL31CB

## LPL31 SERIES

### Mini LED License Light

- Polished, chrome plated housing
- Surface mount on 2" centers
- Design includes both lead and ground wire
- Two LPL31CB/CEZB required to meet DOT requirements, mounted on each side
- Single LPL31CSB required to meet DOT requirements, mounted at center

BULK P/N	POLYPACK P/N	DESCRIPTION	QTY
<b>LICENSE LIGHT - 2 DIODES</b>			
LPL31CB	LPL31CBP	License light	20
LPL31CEZB	LPL31CEZBP	License light, .180 female barrels	20
LPL31CPG	LP31CPGP	License light, .156 female barrels	20
LPL31CSB	LPL31CSBP	Light with spacer	50

#### RETAIL

LPL31CS		Light with mounting hardware, clam	12
---------	---	------------------------------------	----

<b>FMVSS</b>	(2) L
<b>MATERIALS</b>	Polycarbonate lens, chrome plated stainless steel bezel
<b>VOLT/AMP</b>	12.8VDC - 0.027A
<b>WT/DIMS</b>	.066 lb. / 2.563" x 1.188" x .938"
<b>WARRANTY</b>	Lifetime LED Warranty



## LPL41/43 SERIES Surface Mount LED License Light

- Armored housing
- Surface mount using ears or studs
- Design includes both lead and ground wire

BULK P/N	POLYPACK P/N	DESCRIPTION	QTY
<b>LICENSE LIGHT</b>			
LPL41CB	LPL41CBP	5-LED ear mount license light, chrome finish housing	20
LPL42CBF	LPL42CBFP	5-LED stud mount license light, chrome finish housing	20
LPL43CB	LPL43CBP	3-LED ear mount license light, stainless steel housing	20
<b>FMVSS</b>	L		
<b>MATERIALS</b>	Polycarbonate lens, chrome plated housing, stainless steel mounting ears (LPL43 has stainless steel housing)		
<b>VOLT/AMP</b>	12.8VDC - 0.054A		
<b>WT/DIMS</b>	.176 lb. / 4" x 1.75" x 2.188"		
<b>WARRANTY</b>	Lifetime LED Warranty		

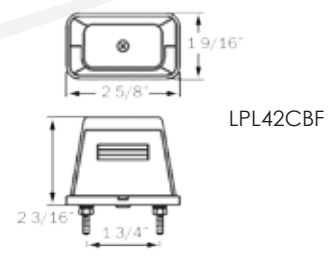

## LPL55 SERIES LED License Light with Bracket

- Light attached to corrosion proof black bracket
- Surface mount on 3-1/4" centers
- Design includes both lead and ground wire



BULK P/N	POLYPACK P/N	DESCRIPTION	QTY
<b>LICENSE LIGHT - 5 DIODES</b>			
LPL55CB	LPL55CBP	Light with ABS bracket	10
LPL55CPG	LPL55CPGP	Light with ABS bracket, female PL-10 plug	10
LPL55CKB	LPL55CKBP	Light/bracket, gasket and hardware	10
LPL56CB	LPL56CBP	Light with steel bracket and gasket	10

<b>FMVSS</b>	L		
<b>MATERIALS</b>	Polycarbonate lens and housing, plastic bracket		
<b>VOLT/AMP</b>	12.8VDC - 0.045A		
<b>WT/DIMS</b>	.198 lb. / 8.625" x 3.25" x 2.375"		
<b>WARRANTY</b>	Lifetime LED Warranty		

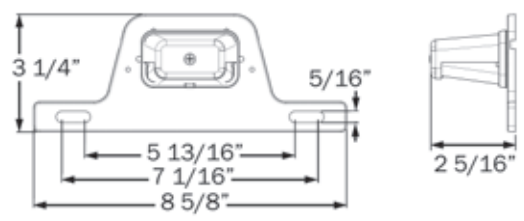



LPL61C24B

## LPL61 SERIES LED License Light

- Sonically sealed, waterproof
- Design includes both lead and ground wire

BULK P/N	POLYPACK P/N	DESCRIPTION	QTY
<b>LICENSE LIGHT - 6 DIODES</b>			
LPL61C24B	LPL61C24BP	LED license light, black housing, 12-24V	50

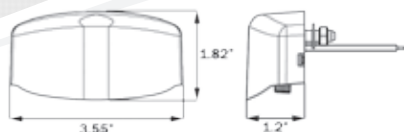

FMVSS	L
MATERIALS	Polycarbonate
VOLT/AMP	12.8VDC - 0.02A
WT/DIMS	.132 lb. / 3.55" x 1.2" x 1.82"
WARRANTY	Lifetime LED Warranty



LPL65CB

## LPL65 SERIES LED License Light

- Sonically sealed, waterproof
- Accept standard 1- or 2-wire plugs
- Single wire design grounds through mounting hardware
- Two-wire design includes both lead and ground wire for mounting to all surfaces

BULK P/N	POLYPACK P/N	DESCRIPTION	QTY
<b>LICENSE LIGHT - 3 DIODES</b>			
LPL65CB	LPL65CBP	LED license light, gray housing	20

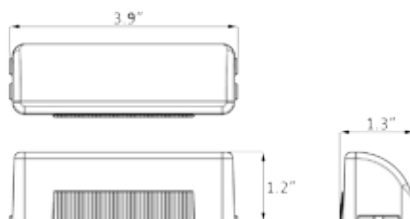

FMVSS	L
MATERIALS	Polycarbonate lens and housing
VOLT/AMP	12.8VDC - 0.052A
WT/DIMS	.089 lb. / 3.9" x 1.3" x 1.2"
WARRANTY	Lifetime LED Warranty

## LPL91 SERIES Sealed LED License Light

- Sonically sealed, waterproof
- Use with LP25SB bracket and designated license plate brackets
- Design includes both lead and ground wire

BULK P/N	POLYPACK P/N	DESCRIPTION	QTY
<b>LICENSE LIGHT - 2 DIODES</b>			
LPL91CB	LPL91CBP	License light	50
LPL91CAB	LPL91CABP	License light, .156 female plugs	50
LPL91CPG	LPL91CPGP	License light, female PL-10 connector	50
LPL91CKB	LPL91CKBP	License light, A91OB chrome base	50
LPL91CBKB	LPL91CBKBP	License light, A91BOB black base	50
LPL91CKALPB	LPL91CKALPBP	License light, .150 female barrels, black light bracket, gasket	50
LPL26SKB	LPL26SKBP	License light, .180 male bullets, gray light bracket	50
<b>LICENSE PLATE BRACKETS</b>			
LP25SB	LP25SBP	Bracket, black coated	100
LP25SGGB	LP25SGGBP	Bracket, gray coated	
LP5SB	LP5SBP	Straight license plate bracket	100
LP15SB	LP15SBP	Zinc license plate bracket	12
LP35BB	LP35BBP	License plate holder	25
<b>ACCESSORIES</b>			
A91BB	A91BBP	Black base, self grounding	100
A91BOB	A91BOBP	Black base, open back	100
A91CB	A91CBP	Chrome base, self grounding	100
A91OB	A91OBP	Chrome base, open back	100
A91GB	A91GBP	Grommet	100

<b>FMVSS</b>	L
<b>MATERIALS</b>	Polycarbonate lens and housing
<b>VOLT/AMP</b>	12.8VDC - 0.027A
<b>WT/DIMS</b>	.066 lb. / 2.5" x 1.25" x 0.813"
<b>WARRANTY</b>	Lifetime LED Warranty



LPL91



LPL26SKB

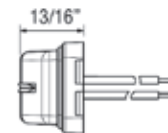
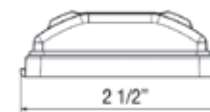

LPL91

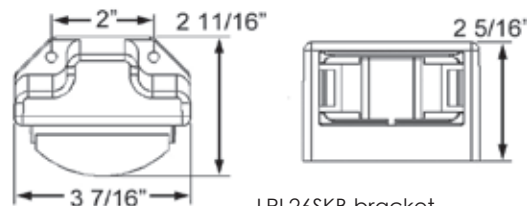

LPL26SKB bracket



BUL13CB

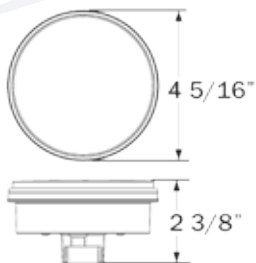

## BUL13 SERIES

### 4" Round Sealed LED Utility Light

- Miro-Flex™ design with Crystal Clear™ lens
- Sonically sealed, waterproof
- Accepts standard two-pin plugs

BULK P/N	POLYPACK P/N	DESCRIPTION	QTY
<b>UTILITY LIGHT - 12 DIODES</b>			
BUL13CB	BUL13CBP	Utility light	10
<b>ACCESSORIES</b>			
A45GB	A45GBP	Grommet	50
A45CB	A45CBP	Pigtail, 2-wire	100
A49PB	A49PBP	Right angle pigtail, 2-wire	100
<b>MATERIALS</b>	Polycarbonate lens and housing		
<b>VOLT/AMP</b>	12.8VDC - 0.074A		
<b>WT/DIMS</b>	.331 lb. / 4.313" x 4.313" x 2.375"		
<b>WARRANTY</b>	Lifetime LED Warranty		



BUL43CB

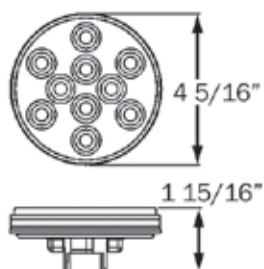

## BUL43 SERIES

### 4" Round Sealed LED Utility Light

- Crystal Clear™ lens
- Sonically sealed, waterproof
- Accepts standard two-pin plugs

BULK P/N	POLYPACK P/N	DESCRIPTION	QTY
<b>UTILITY LIGHT - 10 DIODES</b>			
BUL43CB	BUL43CBP	Utility light	10
BUL43CBK	BUL43CBKP	Kit with A45GB grommet and A45CB pigtail	10
<b>ACCESSORIES</b>			
A45GB	A45GBP	Grommet	50
A45CB	A45CBP	Pigtail, 2-wire	100
A49PB	A49PBP	Right angle pigtail, 2-wire	100
<b>MATERIALS</b>	Polycarbonate lens and housing		
<b>VOLT/AMP</b>	12.8VDC - 0.275A		
<b>WT/DIMS</b>	.529 lb. / 4.313" x 4.313" x 1.938"		
<b>WARRANTY</b>	Lifetime LED Warranty		

## BUL69 SERIES

### Sealed LED Thinline Utility Light



- Sonically sealed, waterproof
- Ultra thin – only 5/8" thick
- Design includes both lead and ground wire



BUL69CB

BULK P/N	POLYPACK P/N	DESCRIPTION	QTY
<b>UTILITY LIGHT - 11 DIODES</b>			
BUL69CB	BUL69CBP	Utility light	10
BUL69CPG	BUL69CPGP	Light with .180 male bullets	10
BUL69CBMCV2B	BUL69CBMCV2BP	Kit: 2-wire female PL-3, A69CB base	10
<b>ACCESSORIES</b>			
A69CB	A69CBP	Chrome base/bezel	10

<b>MATERIALS</b>	Polycarbonate lens and housing
<b>VOLT/AMP</b>	12.8VDC - 0.025A
<b>WT/DIMS</b>	.265 lb. / 15" x 1.375" x .625"
<b>WARRANTY</b>	Lifetime LED Warranty

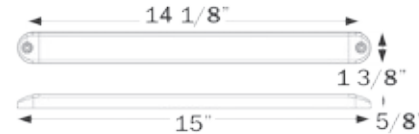

## BUL72 SERIES

### 6" Oval Sealed LED Utility Lights



- Crystal Clear™ lens
- Sonically sealed, waterproof
- Accepts standard two-pin plugs



BUL72CB

BULK P/N	POLYPACK P/N	DESCRIPTION	QTY
<b>UTILITY LIGHT - 10 DIODES</b>			
BUL72CB	BUL72CBP	Utility light	10
BUL72CBGK	BUL72CBGKP	Utility light with A70GB grommet	50
BUL74CBK	BUL74CBKP	Utility light with A70GB & A49PB	50
<b>ACCESSORIES</b>			
A70GB	A70GBP	Grommet	50
A45CB	A45CBP	Pigtail, 2-wire	100
A49PB	A49PBP	Right angle pigtail, 2-wire	100

<b>MATERIALS</b>	Polycarbonate lens and housing
<b>VOLT/AMP</b>	12.8VDC - 0.080A
<b>WT/DIMS</b>	.529 lb. / 6.438" x 2.313" x 1.75"
<b>WARRANTY</b>	Lifetime LED Warranty

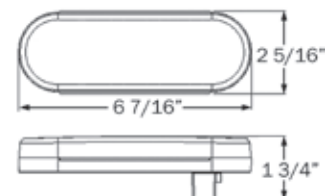



BUL73CB

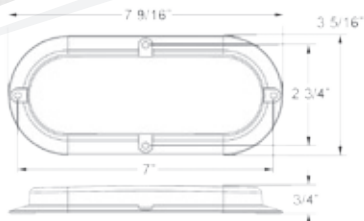

## BUL73 SERIES

### FLEET Count™ 6" Oval Sealed LED Utility Light for Surface Mount

- Sonically sealed, waterproof
- Surface flange mount – no panel cutout required
- Design includes both lead and ground wire

BULK P/N	POLYPACK P/N	DESCRIPTION	QTY
<b>UTILITY LIGHT - 6 DIODES</b>			
BUL73CB	BUL73CBP	Utility light	10
<b>ACCESSORIES</b>			
A78CB	A78CBP	Chrome trim ring	25
<b>MATERIALS</b>	Polycarbonate lens and housing		
<b>VOLT/AMP</b>	12.8VDC - 0.054A		
<b>WT/DIMS</b>	.265 lb. / 7.563" x 3.313" x .75"		
<b>WARRANTY</b>	Lifetime LED Warranty		



BUL78CB

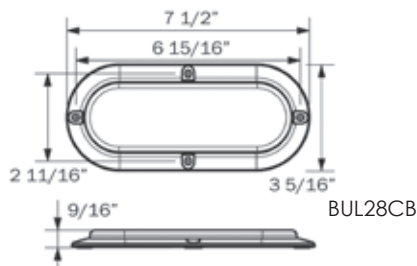
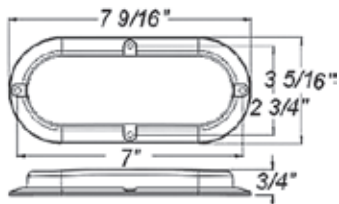

BUL28CB

## BUL78 SERIES

### 6" Oval Sealed LED Utility Light for Surface Mount

- Sonically sealed, waterproof
- Surface flange mount – no panel cutout required
- Design includes both lead and ground wire

BULK P/N	POLYPACK P/N	DESCRIPTION	QTY
<b>UTILITY LIGHT - 10 DIODES</b>			
BUL78CB	BUL78CBP	Utility light	10
BUL78CEZB	BUL78CEZBP	Utility light with 2-way female PL-3	10
BUL78C3MB	BUL78C3MBP	Utility light with 2-way female PL-3 plug, adhesive back	10
BUL28CLPB	BUL28CLPBP	Low profile utility light with 2-way female PL-3 connector and gasket	10
<b>ACCESSORIES</b>			
A78CB	A78CBP	Chrome trim ring	25
<b>MATERIALS</b>	Polycarbonate lens and housing		
<b>VOLT/AMP</b>	12.8VDC - 0.054A		
<b>WT/DIMS</b>	BUL78: .265 lb. / 7.563" x 3.313" x .75" BUL28: .255 lb. / 7.50" x 3.313" x .5625"		
<b>WARRANTY</b>	Lifetime LED Warranty		

## UCL178 SERIES

### GloLight® 6" Oval Sealed LED Utility Light for Surface Mount

PATENTED TECHNOLOGY

- Sonically sealed, waterproof
- Surface flange mount – no panel cutout required
- Design includes both lead and ground wire

BULK P/N	POLYPACK P/N	DESCRIPTION	QTY
<b>UTILITY LIGHT - 22 DIODES</b>			
UCL178RFP2B	UCL178RFP2BP	Utility light	10
<b>ACCESSORIES</b>			
A7TRSSB	A7TRSSBP	Stainless steel trim ring	100
A78CB1	A78CB1P	Chrome trim ring	25

<b>MATERIALS</b>	Polycarbonate lens and housing
<b>VOLT/AMP</b>	12.8VDC - 0.050A
<b>WT/DIMS</b>	.265 lb. / 7.50" x 3.25" x 1.25"
<b>WARRANTY</b>	Lifetime LED Warranty

**GloLight®**



UCL178RFP2B

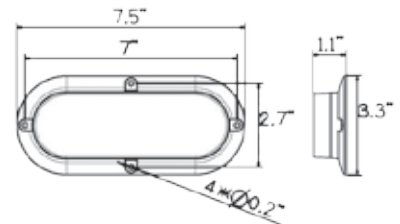

## UCL09 SERIES

### 3" Sealed LED Utility/Hitch Light for Surface Mount

- Designed to illuminate hitch area of trailer
- Sonically sealed, waterproof
- Flange surface mount – no panel cutout required
- Design includes both lead and ground wire

BULK P/N	POLYPACK P/N	DESCRIPTION	QTY
<b>UTILITY LIGHT - 9 DIODES</b>			
UCL09CB	UCL09CBP	Utility light, 9 white LEDs	50
UCL09CBB	UCL09CBBP	Utility light, 6 white, 3 blue LEDs, 3-wire	50
<b>ACCESSORIES</b>			
A09BB	A09BBP	Black snap-on trim ring	50
A09CB	A09CBP	Chrome snap-on trim ring	50
A09WB	A09WBP	White snap-on trim ring	50

<b>MATERIALS</b>	Polycarbonate lens and housing
<b>VOLT/AMP</b>	UCL09CB: 12.8VDC - 0.074A UCL09CBB: 12.8VDC - 0.114A
<b>WT/DIMS</b>	.265 lb. / 3.25" x 3.25" x .813"
<b>WARRANTY</b>	Lifetime LED Warranty

**Optronics  
LED**



UCL09CB



UCL09CBB

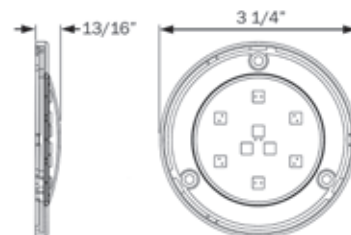



UCL11CKB

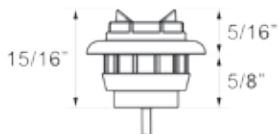

## UCL11 SERIES 3/4" Sealed LED Utility Light

- Sealed, waterproof
- Compact – fits 3/4" hole
- Design includes both lead and ground wire

BULK P/N	POLYPACK P/N	DESCRIPTION	QTY
<b>UTILITY LIGHT - 2 DIODES</b>			
UCL11CB	UCL11CBP	Utility light	50
UCL11CKB	UCL11CKBP	Kit: UCL11CB & A11GB grommet	50
UCL11CKPG	UCL11CKPGP	Kit: UCL11CB with .180 male bullets & A14GB grommet	50
<b>ACCESSORIES</b>			
A11GB	A11GBP	Grommet	100
A14GB	A14GBP	Sealing grommet, .125-.250" material	100
A11PB	A11PBP	Snap-in mounting flange	100

<b>MATERIALS</b>	Polycarbonate lens and housing
<b>VOLT/AMP</b>	12.8VDC - 0.054A
<b>WT/DIMS</b>	.265 lb. / 0.74" x 0.74" x 0.938"
<b>WARRANTY</b>	Lifetime LED Warranty



UCL13C2PG



UCL13CB2B



## UCL13 SERIES Sealed LED Utility Light

- Sealed, waterproof
- Compact, surface mount design
- Design includes both lead and ground wire

BULK P/N	POLYPACK P/N	DESCRIPTION	QTY
<b>WHITE UTILITY LIGHT - 2 DIODES</b>			
UCL13C2PG	UCL13C2PGP	Utility light, .180 female barrels	20
UCL13CPG	UCL13CPGP	Utility light, .156 male bullets	20
<b>BLUE - 2 DIODES</b>			
UCL13CB2B	UCL13CB2BP	Blue LED utility light	20
<b>ACCESSORIES</b>			
A13C2B	A13C2BP	Chrome base/bezel	100
A13B2B	A13B2BP	Black base/bezel	100
A13G2B	A13G2BP	Gasket	200

<b>MATERIALS</b>	Polycarbonate lens and housing
<b>VOLT/AMP</b>	12.8VDC - 0.020A
<b>WT/DIMS</b>	.088 lb. / 2.5" x 1.063" x .688"
<b>WARRANTY</b>	Lifetime LED Warranty



## UCL19 SERIES

### Miro-Flex™ Sealed LED Utility Light

- Sealed, waterproof
- Surface mount, mounts on 4-5/8" centers
- Design includes both lead and ground wire

BULK P/N	POLYPACK P/N	DESCRIPTION	QTY
<b>UTILITY LIGHT - 4 DIODES</b>			
UCL19CB	UCL19CBP	Utility light	20

<b>MATERIALS</b>	Polycarbonate lens and housing
<b>VOLT/AMP</b>	12.8VDC - 0.051A
<b>WT/DIMS</b>	.132 lb. / 5.75" x 1.563" x .75"
<b>WARRANTY</b>	Lifetime LED Warranty



UCL19CB

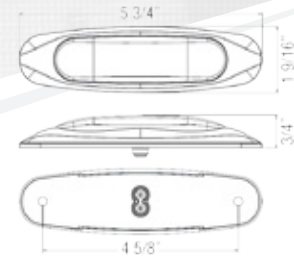

## UCL50 SERIES

### Miro-Flex™ 2" Sealed LED Utility Light

- Miro-Flex™ design with Crystal Clear™ lens
- Operating voltage 12-24VDC
- Sonically sealed, waterproof
- Accepts standard two-pin PL-10 plug

BULK P/N	POLYPACK P/N	DESCRIPTION	QTY
<b>UTILITY LIGHT - 9 DIODES</b>			
UCL50CB	UCL50CBP	12-24VDC Utility light	20

<b>ACCESSORIES</b>			
A46PB	A46PBP	Straight plug, 6" lead	100
A86PB	A86PBP	Straight plug, 18" lead	100
A54GB	A54GBP	2" Flush mount grommet	100
A54GK	A54GKP	2" Kit: A54GB and A46PB	100
A55CB	A55CBP	2" Chrome trim ring	20
BK5557GB	BK5557GBP	Cam-on mounting bracket	50

<b>MATERIALS</b>	Polycarbonate lens and housing
<b>VOLT/AMP</b>	12.8VDC - 0.013A
<b>WT/DIMS</b>	.088 lb. / 2" x 2" x 1.188"
<b>WARRANTY</b>	Lifetime LED Warranty



UCL50CB

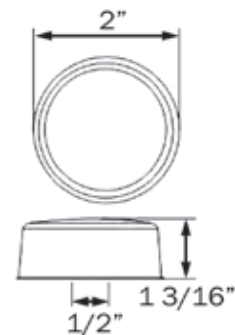



UCL55CB

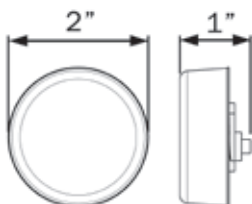

## UCL55 SERIES 2" Sealed LED Utility Light

- Sonically sealed, waterproof
- Accepts standard two-pin PL-10 plug

BULK P/N	POLYPACK P/N	DESCRIPTION	QTY
<b>UTILITY LIGHT - 3 DIODES</b>			
UCL55CB	UCL55CBP	Utility light	20
<b>ACCESSORIES</b>			
A46PB	A46PBP	Straight plug, 6" lead	100
A86PB	A86PBP	Straight plug, 18" lead	100
A54GB	A54GBP	2" Flush mount grommet	100
A54GK	A54GKP	2" Kit: A54GB and A46PB	100
A55CB	A55CBP	2" Chrome trim ring	20
BK5557GB	BK5557GBP	Cam-on mounting bracket	50

<b>MATERIALS</b>	Polycarbonate lens and housing
<b>VOLT/AMP</b>	12.8VDC - 0.047A
<b>WT/DIMS</b>	.088 lb. / 2" x 2" x 1"
<b>WARRANTY</b>	Lifetime LED Warranty



UCL65CB



## UCL65 SERIES Sealed LED Thinline Utility Light

- Sealed, waterproof
- Multiple mounting and wiring options available

BULK P/N	POLYPACK P/N	DESCRIPTION	QTY
<b>UTILITY LIGHT - 6 DIODES</b>			
UCL65CB	UCL65CBP	Utility light	20
<b>ACCESSORIES</b>			
A65B	A65BP	Black bracket	50
A65P	A65PP	Single wire plug, .156 male bullet	50
A65PB	A65PBP	Kit: A65B black bracket & A65P plug	50
A66PB	A66PBP	Kit: Gray bracket & A65P plug	50
A67CB	A67CBP	Kit: Chrome bracket & A65P plug	50
A68PB	A68PBP	Kit: Black bracket & 2-wire plug	50

For more details on mounting and wiring accessories, see Accessories section at back of catalog.

<b>MATERIALS</b>	Polycarbonate lens and housing
<b>VOLT/AMP</b>	12.8VDC - 0.048A
<b>WT/DIMS</b>	.066 lb. / 3.875" x 1.25" x 1.125"
<b>WARRANTY</b>	Lifetime LED Warranty

## UCL60/160 SERIES Sealed LED Utility Light

- Sealed, waterproof
- Compact, surface mount design
- Design includes both lead and ground wire
- CSA certified for use in sleeping quarters
- Snap-on trim ring included, multiple finishes available

BULK P/N	POLYPACK P/N	DESCRIPTION	QTY
<b>TOUCH SWITCH UTILITY LIGHT - 6 DIODES</b>			
UCL60CSBB	UCL60CSBBP	Utility light, black trim ring	20
UCL60CSNB	UCL60CSNBP	Utility light, brushed nickel trim ring	20
UCL60CSWNB	UCL60CSWNBP	Utility light, warm white LED, brushed nickel trim ring	20
<b>UTILITY LIGHT, NO SWITCH - 6 DIODES</b>			
UCL60CB	UCL60CBP	Utility light, chrome trim ring	20
UCL60CSCB	-	Utility light, chrome trim ring, Delphi connector	20
UCL60CBB	UCL60CBBP	Utility light, black trim ring	20

**Raw lumen output:** 224 lm  
**Effective lumen output:** 168 lm

BULK P/N	POLYPACK P/N	DESCRIPTION	QTY
<b>GLOLIGHT™ UTILITY LIGHT - 6 DIODES</b>			
UCL160CB	UCL160CBP	Utility light, chrome trim ring	20

**Raw lumen output:** 224 lm  
**Effective lumen output:** 168 lm

<b>MATERIALS</b>	Polycarbonate lens and housing
<b>VOLT/AMP</b>	12.8VDC - 0.020A
<b>WT/DIMS</b>	.088 lb. / 3" x 3" x .375"
<b>WARRANTY</b>	Lifetime LED Warranty

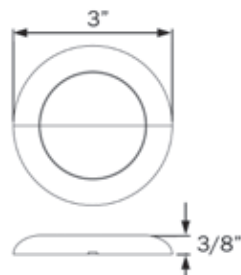



## ILLO1 SERIES 3/4" LED Emergency Egress Light



- 3/4" recess mount light for use in transit vehicles
- Hard wired, includes lead and ground with female Staykon connectors
- Sealed, waterproof construction – maintenance free
- Snap-in design for quick and easy installation

BULK P/N	BOX/UPC P/N	DESCRIPTION	QTY
<b>EGRESS LIGHT - 1 DIODE</b>			
ILL01RB	ILL01RBP	3/4" egress light	50

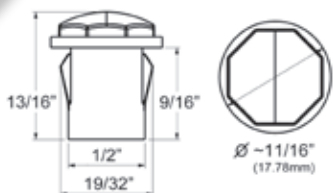

<b>MATERIALS</b>	Polycarbonate lens and housing
<b>VOLT/AMP</b>	12.8VDC - .1A
<b>WT/DIMS</b>	0.018 lb. / .695" x .695" x .81"
<b>WARRANTY</b>	Lifetime LED Warranty



## ILLO6/07 SERIES Opti-Brite™ LED Mini Dome Light



ILLO6COB

- Compact 11-inch dome light fits many applications
- Design includes 6-inch, 16-gauge power and ground wires with tinned ends
- Available with neutral white or cool white LEDs



A06TR

BULK P/N	POLYPACK P/N	DESCRIPTION	QTY
<b>COOL WHITE - 16 DIODES</b>			
ILL06COB	ILL06COBP	Dome light, white trim ring	12
ILL06COPG	ILL06COPGP	Dome light, .180 bullets, white trim ring	12
<b>NEUTRAL WHITE - 16 DIODES</b>			
ILL07COB	ILL07COBP	Neutral white LEDs	12
<b>ACCESSORIES</b>			
A06TR	A06TRP	White trim ring	50

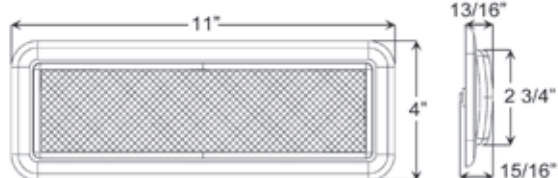

**Raw lumen output:** 643 lm  
**Effective lumen output:** 354 lm

<b>MATERIALS</b>	Polycarbonate lens and housing
<b>VOLT/AMP</b>	12.8VDC - .48A
<b>WT/DIMS</b>	.05 lbs. / 11" x 4" x .94"
<b>WARRANTY</b>	Lifetime LED Warranty

## ILLO8 SERIES

### Opti-Brite™ LED Dome Lights

- Designed for use in extreme temperatures; ideal for refrigerated trucks and trailers (-40 to 140 degrees F)
- Operating voltage 7-30VDC; voltage cut-off at 7VDC prevents battery drain
- Use with both 12VDC and 24VDC systems; light output remains consistent at all operating voltages (no dimming), cutting off when voltage is outside range
- Design includes 16-inch, 16-gauge power and ground wires with tinned ends



ILL08COB



ILL28CMB



BULK P/N	BOX/UPC P/N	DESCRIPTION	QTY
<b>DOMELIGHT - 8 DIODES</b>			
ILL08COB	ILL08COBP	Light	6
ILL08COPG	ILL08COPGP	Light, .180 male bullets,	6
<b>MOTION SENSOR DOMELIGHT - 8 DIODES</b>			
ILL28CMB	ILL28CMBP	Light with motion sensor	6
ILL28CMPG	ILL28CMPGP	Light with motion sensor, .180 male bullets	6

**Raw lumen output:** 1400 lm  
**Effective lumen output:** 990 lm

<b>MATERIALS</b>	Polycarbonate lens and housing
<b>VOLT/AMP</b>	12.8VDC - 1.61A; 24VDC - 0.80A
<b>WT/DIMS</b>	1 lb. / 18.25" x 5.75" x 1.078"
<b>WARRANTY</b>	Lifetime LED Warranty

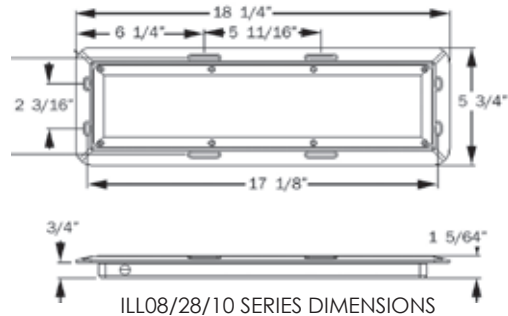

## ILL10 SERIES

### Opti-Brite™ LED Dome Light

For 12VDC systems, general applications

BULK P/N	BOX/UPC P/N	DESCRIPTION	QTY
<b>DOMELIGHT - 10 DIODES</b>			
ILL10CCB	ILL10CCBP	11-16VDC Dome light	6

**Raw lumen output:** 1100 lm  
**Effective lumen output:** 880 lm

<b>MATERIALS</b>	Polycarbonate lens and housing
<b>VOLT/AMP</b>	12.8VDC - 1.8A
<b>WT/DIMS</b>	1 lb. / 18.25" x 5.75" x 1.078"
<b>WARRANTY</b>	Lifetime LED Warranty



ILL10CCB

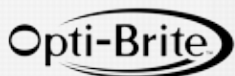

ILL21CB

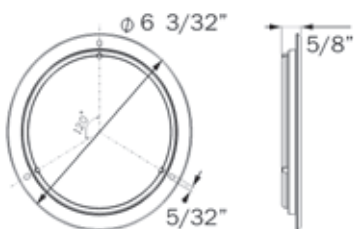

## ILL21 SERIES

### Opti-Brite™ LED 6" Dome Light

- Low profile dome light – less than 5/8" thick
- Operating voltage 12-24VDC; use with both 12VDC and 24VDC systems
- Low voltage cut-off at 11VDC, prevents battery drain
- Sealed, waterproof

BULK P/N	POLYPACK P/N	DESCRIPTION	QTY
<b>DOMELIGHT - 21 DIODES</b>			
ILL21CB	ILL21CBP	Dome light, two-wire, .180 male bullets	10
ILL21CTPB	-	ILL21CB with adhesive mounting pad	10
A21CHB	-	Chrome trim ring	25

**Raw lumen output:** 250 lm

**Effective lumen output:** 214 lm

<b>MATERIALS</b>	Polycarbonate lens and housing
<b>VOLT/AMP</b>	12.8VDC - .408A; 24VDC - .385A
<b>WT/DIMS</b>	.250 lb. / 6.0938" x 6.0938" x .625"
<b>WARRANTY</b>	Lifetime LED Warranty



ILL39CB

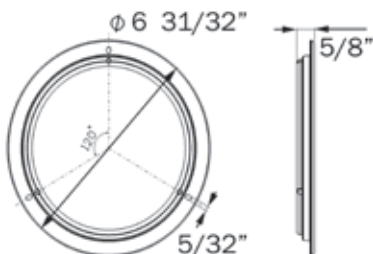

## ILL39 SERIES

### Opti-Brite™ LED 7" Dome Light

- Low profile dome light – less than 5/8" thick
- Operating voltage 12-24VDC; use with both 12VDC and 24VDC systems
- Low voltage cut-off at 11VDC, prevents battery drain
- Hard wired design includes 16-gauge power and ground wires with .180 male bullets
- Sealed, waterproof

BULK P/N	POLYPACK P/N	DESCRIPTION	QTY
<b>DOMELIGHT - 39 DIODES</b>			
ILL39CB	ILL39CBP	Dome light	5/10

**Raw lumen output:** 460 lm

**Effective lumen output:** 390 lm

<b>MATERIALS</b>	Polycarbonate lens and housing
<b>VOLT/AMP</b>	12.8VDC - .669A; 24VDC - .217A
<b>WT/DIMS</b>	.350 lb. / 6.969" x 6.969" x .625"
<b>WARRANTY</b>	Lifetime LED Warranty

## ILL25/26 SERIES LED Low Profile Interior Lights



### PATENTED TECHNOLOGY

- Low profile dome lights
- Surface mount
- Hard wired design includes both lead and ground wire

BULK P/N	POLYPACK P/N	DESCRIPTION	QTY
<b>DOMELIGHT - 12 DIODES</b>			
ILL25CB	ILL25CBP	Interior light, 3.5"	20

<b>Raw lumen output:</b>	400 lm
<b>Effective lumen output:</b>	260 lm

BULK P/N	POLYPACK P/N	DESCRIPTION	QTY
<b>DOMELIGHT - 18 DIODES</b>			
ILL26CB	ILL26CBP	Interior light, 4.5"	10

<b>Raw lumen output:</b>	600 lm
<b>Effective lumen output:</b>	390 lm

<b>MATERIALS</b>	Polycarbonate lens and housing
<b>VOLT/AMP</b>	ILL25CB: 12.8VDC - .32A ILL26CB: 12.8VDC - .42A
<b>WT/DIMS</b>	ILL25CB: .097 lb. / 3.50" x 3.50" x .75" ILL26CB: .156 lb. / 4.50" x 4.50" x .875"
<b>WARRANTY</b>	Lifetime LED Warranty

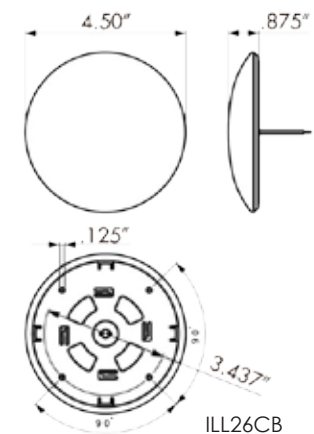
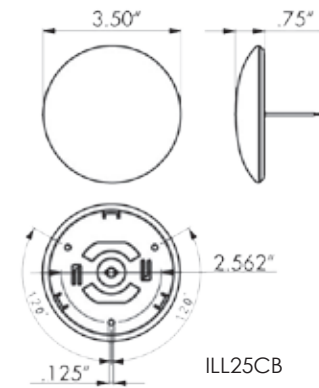

LED INTERIOR/UTILITY LIGHTS

## ILL22 SERIES Sealed LED Dome Lights

- Low profile dome lights – only 1” thick
- Sealed, waterproof design
- Hard wired with 6” power and ground wires



BULK P/N	POLYPACK P/N	DESCRIPTION	QTY
<b>DOMELIGHT - 18 DIODES</b>			
ILL22CB	ILL22CBP	Dome light, on/off switch	10
ILL22CHB	ILL22CHBP	Dome light, no switch	10

ILL22CB

**Raw lumen output:** 1044 lm  
**Effective lumen output:** 810 lm

<b>MATERIALS</b>	Polycarbonate lens and housing
<b>VOLT/AMP</b>	12.8VDC - .7A
<b>WT/DIMS</b>	.182 lb. / 4.5” x 2.875” x 1”
<b>WARRANTY</b>	Lifetime LED Warranty

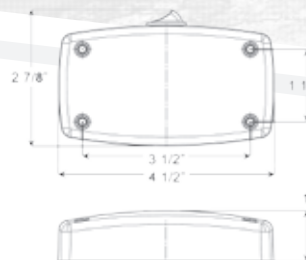

## ILL24 SERIES Sealed LED 6” Dome Light

- Low profile dome light – only 7/8” thick
- Sealed, waterproof
- Hard wired design includes power and ground wires



ILL24CB

BULK P/N	POLYPACK P/N	DESCRIPTION	QTY
<b>DOMELIGHT - 24 DIODES</b>			
ILL24CB	ILL24CBP	Dome light	10

**Raw lumen output:** 585 lm  
**Effective lumen output:** 453 lm

<b>MATERIALS</b>	Polycarbonate lens and housing
<b>VOLT/AMP</b>	12.8VDC - .127A
<b>WT/DIMS</b>	.353 lb. / 6.125” x 6.125” x 0.875”
<b>WARRANTY</b>	Lifetime LED Warranty

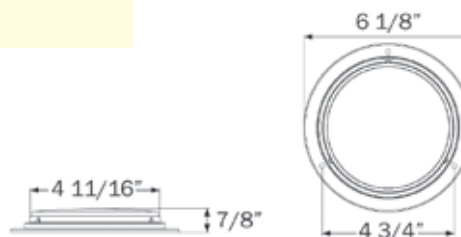



## ILL30CBB SERIES Constellation™ LED Bullet Light



- Surface mount fixture; trim ring covers mounting hardware
- Ratchet motion design with on/off switch
- Lightly frosted lens
- Hard wired design includes power and ground wires



ILL30CBB

BULK P/N	POLYPACK P/N	DESCRIPTION	QTY
<b>BULLET LIGHT - 1 DIODE</b>			
ILL30CBB	ILL30CBBP	Bullet light	25

<b>MATERIALS</b>	Plastic housing
<b>VOLT/AMP</b>	12.8VDC - .288A
<b>WT/DIMS</b>	.250 lb. / 3.75" x 1.938" x 3.5"
<b>WARRANTY</b>	Lifetime LED Warranty

## ILL31/32/35 SERIES LED Low Profile Dome Lights



- Low profile dome lights for semi-recess or surface mount
- Durable steel housing and replaceable polycarbonate lens
- Hard wired design includes power and ground wires
- Select from standard diode or SMD LED models



ILL31CB

BULK P/N	POLYPACK P/N	DESCRIPTION	QTY
<b>RECESS MOUNT DOME LIGHT - 10 DIODES</b>			
ILL31CB	ILL31CBP	Standard LED	10
ILL35CB	-	SMD LED	10
<b>SURFACE MOUNT DOME LIGHT - 10 DIODES</b>			
ILL32CB	ILL32CBP	SMD LED	10
ILL32CPG	-	SMD LED, .180 male bullets	10

**Raw lumen output:** 70 lm  
**Effective lumen output:** 53 lm

<b>MATERIALS</b>	Polycarbonate lens, plated steel housing
<b>VOLT/AMP</b>	12.8VDC - .024A
<b>WT/DIMS</b>	ILL31/35: .243 lb. / 5.75" x 2.75" x .938" ILL32: .243 lb. / 5.75" x 2.75" x .75"
<b>WARRANTY</b>	Lifetime LED Warranty

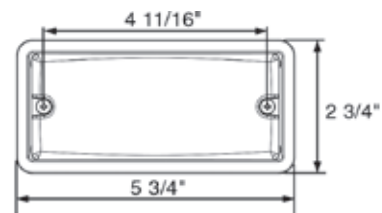

ILL31/32/35



ILL31/35 - recess mount



ILL32 - surface mount



ILL33CB

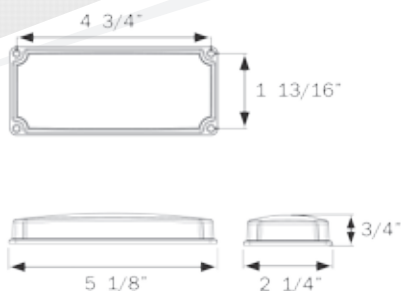

## ILL33 SERIES

### Opti-Brite™ LED Sealed Dome Light

- Low profile surface mount design – less than 3/4" thick
- Hard wired design includes 18-gauge lead wires
- Sealed, waterproof

BULK P/N	POLYPACK P/N	DESCRIPTION	QTY
<b>DOME LIGHT - 10 DIODES</b>			
ILL33CB	ILL33CBP	Dome light	10

**Raw lumen output:** 210 lm  
**Effective lumen output:** 160 lm

<b>MATERIALS</b>	Polycarbonate lens and housing
<b>VOLT/AMP</b>	12.8VDC - .147A
<b>WT/DIMS</b>	.154 lb. / 5.125" x 2.25" x .75"
<b>WARRANTY</b>	Lifetime LED Warranty



ILL36CB

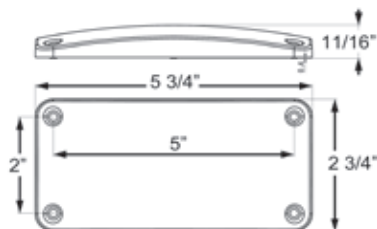

## ILL36 SERIES

### Opti-Brite™ LED Sealed Dome Light

- Low profile surface mount design – less than 3/4" thick
- Sealed, waterproof
- Durable polycarbonate construction

BULK P/N	POLYPACK P/N	DESCRIPTION	QTY
<b>DOME LIGHT - 9 DIODES</b>			
ILL36CB	ILL36CBP	Dome light	10
ILL36CPG	ILL36CPGP	Dome light, .180 male bullets	10

**Raw lumen output:** 400 lm  
**Effective lumen output:** 227 lm

<b>MATERIALS</b>	Polycarbonate lens and housing
<b>VOLT/AMP</b>	12.8VDC - .33A
<b>WT/DIMS</b>	.154 lb. / 5.75" x 2.75" x .688"
<b>WARRANTY</b>	Lifetime LED Warranty

## ILL45 SERIES

### Opti-Brite™ LED Interior Light

- Low profile surface mount design – less than 1" thick
- Durable polycarbonate construction



ILL45CB

BULK P/N	POLYPACK P/N	DESCRIPTION	QTY
<b>INTERIOR LIGHT - 42 DIODES</b>			
ILL45CB	ILL45CBP	Interior light	50

**Raw lumen output:** 300 lm  
**Effective lumen output:** 260 lm

<b>MATERIALS</b>	Polycarbonate lens and housing
<b>VOLT/AMP</b>	12.8VDC - .37A
<b>WT/DIMS</b>	.206 lbs. / 4.625" x 4.625" x .79"
<b>WARRANTY</b>	Lifetime LED Warranty



## ILL46 SERIES

### Opti-Brite™ Sealed LED Dome Light

- Low profile surface mount design – less than 3/4" thick
- Sealed, waterproof
- Durable polycarbonate construction



ILL46CB

BULK P/N	POLYPACK P/N	DESCRIPTION	QTY
<b>DOMELIGHT - 9 DIODES</b>			
ILL46CB	ILL46CBP	Dome light	10

**Raw lumen output:** 540 lm  
**Effective lumen output:** 380 lm

<b>MATERIALS</b>	Polycarbonate lens and housing
<b>VOLT/AMP</b>	12.8VDC - .33A
<b>WT/DIMS</b>	.154 lbs. / 5.75" x 2.75" x .688"
<b>WARRANTY</b>	Lifetime LED Warranty

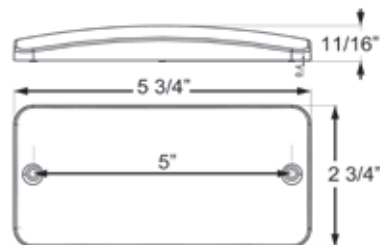



ILL70CB



ILL71CB



ILL72CB



ILL70ABAWN

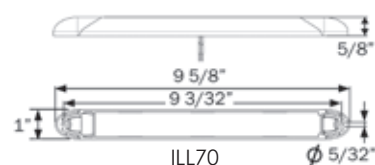

ILL70

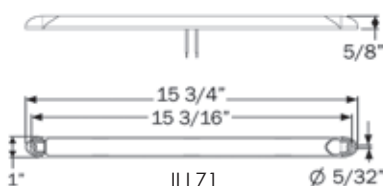

ILL71

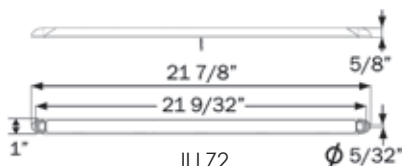

ILL72

### MATERIALS

Polycarbonate lens and housing

### VOLT/AMP

ILL70: 12.8VDC - .150A

ILL71: 12.8VDC - .300A

ILL72: 12.8VDC - .480A

### WT/DIMS

ILL70: .154 lb. / 9.625" x 1" x .625"

ILL71: .187 lb. / 15.75" x 1" x .625"

ILL72: .210 lb. / 21.875" x 1" x .625"

### WARRANTY

Lifetime LED Warranty

## ILL70/71/72 SERIES

### Opti-Brite™ LED Interior Strip Lights for Surface Mount

- Low profile, slimline lights – only 1" wide by 5/8" thick
- Hard wired design includes both lead and ground wires
- Select from 9-inch, 16-inch and 22-inch strip lights and 11" and 18" awning lights
- Sealed, waterproof

BULK P/N	POLYPACK P/N	DESCRIPTION	QTY
<b>9" WHITE LED STRIP LIGHT - 9 DIODES</b>			
ILL70CB	ILL70CBP	Strip light	20/10
ILL70CSB	ILL70CSBP	Strip light with on/off switch	10
<b>11" WHITE LED AWNING LIGHT - 9 DIODES</b>			
ILL70CBAWN	ILL70CBAWN	No switch, chrome housing	10
ILL70CBBAWN	ILL70CBBAWN	No switch, black housing	10
ILL70CBSAWN	ILL70CBSAWN	On/off switch, black housing	10
ILL70CCSAWN	ILL70CCSAWN	On/off switch, chrome housing	10
<b>11" AMBER LED AWNING LIGHT - 9 DIODES</b>			
ILL70ABAWN	ILL70ABAWN	No switch, chrome housing	10
ILL70ABBAWN	ILL70ABBAWN	No switch, black housing	10
<b>Raw lumen output: 189 lm</b> <b>Effective lumen output: 171 lm</b>			
<b>16" WHITE LED STRIP LIGHT - 18 DIODES</b>			
ILL71CB	ILL71CBP	Strip light	20/10
ILL71CSB	ILL71CSBP	Strip light with on/off switch	10
ILL71CPG	ILL71CPGP	Strip light, .180 male bullets	10
<b>18" WHITE LED AWNING LIGHT - 18 DIODES</b>			
ILL71CBAWN	ILL71CBAWN	No switch, chrome housing	10
<b>Raw lumen output: 370 lm</b> <b>Effective lumen output: 342 lm</b>			
<b>22" WHITE LED STRIP LIGHT - 27 DIODES</b>			
ILL72CB	ILL72CBP	Strip light	20/10
<b>Raw lumen output: 567 lm</b> <b>Effective lumen output: 513 lm</b>			

## ILL85 SERIES LED Exterior Step/Area Light

- Illuminate step well or pavement at base of steps or ramps
- Meets ADA lighting standard
- Surface mount, 3.662" mounting centers
- Hard wired design includes both lead and ground wires
- Operating voltage 8-30VDC, for use with 12VDC or 24VDC systems
- Polycarbonate construction with polished chrome finish
- Mounting gasket included



ILL85CB

BULK P/N	POLYPACK P/N	DESCRIPTION	QTY
<b>STEP/AREA LIGHT - 10 DIODES</b>			
ILL85CB	ILL85CBP	Step/area light	10

<b>MATERIALS</b>	Polycarbonate lens and housing
<b>VOLT/AMP</b>	12.8VDC - .107A
<b>WT/DIMS</b>	.154 lb. / 4.25" x 1.24" x 1.69"
<b>WARRANTY</b>	Lifetime LED Warranty

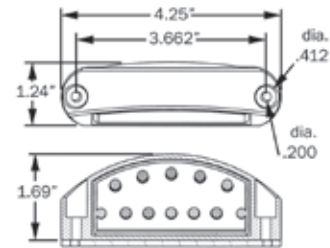

## ILL86 SERIES LED Exterior Step/Area Light

- Illuminate step well or pavement at base of steps or ramps
- Meets ADA lighting standard
- Surface mount, 2.92" mounting centers
- Hard wired design includes both lead and ground wires
- Die cast aluminum housing coated for protection against corrosion and UV exposure; polycarbonate lens



ILL86CB

BULK P/N	POLYPACK P/N	DESCRIPTION	QTY
<b>STEP/AREA LIGHT - 5 DIODES</b>			
ILL86CB	ILL86CBP	Step/area light, white finish	10
ILL86BCB	ILL86BCBP	Step/area light, black finish	10

<b>MATERIALS</b>	Die cast aluminum housing, polycarbonate lens
<b>VOLT/AMP</b>	12.8VDC - .25A
<b>WT/DIMS</b>	.154 lb. / 4" x 2.5" x 1.313"
<b>WARRANTY</b>	Lifetime LED Warranty

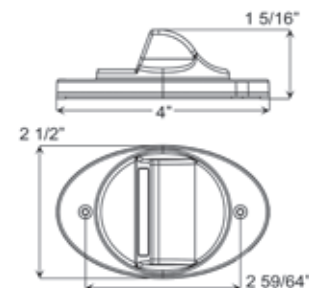



ILL91CB

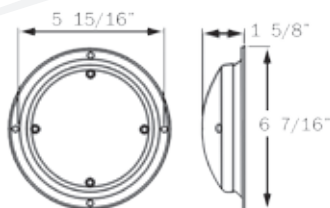

## ILL91 SERIES 6" LED Interior Dome Light

- Surface mount steel base, chrome plated
- Hard wired design includes both lead and ground wires
- Two diodes provide low amp draw, bright white light

BULK P/N	POLYPACK P/N	DESCRIPTION	QTY
<b>DOMELIGHT - 6 DIODES</b>			
ILL91CB	ILL91CBP	Dome light	50
ILL91CPG	ILL91CPGP	Dome light, .180 male bullets	50
<b>Raw lumen output: 600 lm</b>			
<b>Effective lumen output: 540 lm</b>			

<b>MATERIALS</b>	Polycarbonate lens and housing
<b>VOLT/AMP</b>	12.8VDC - .35A
<b>WT/DIMS</b>	.154 lb. / 6.438" x 6.438" x 1.625"
<b>WARRANTY</b>	Lifetime LED Warranty



LM112CB



LM315BB



LM835CB

## LM SERIES LED Utility, Courtesy & Accent Lights

- LM112CB is recess mount waterproof light for use above or below water level. Single diode. Plastic housing.
- LM315BB is semi-recess mount courtesy light
- LM835CB is eight-diode recess mount accent light with clear lens and chrome trim ring; screw mount
- All models are hard wired with ground wire

BULK P/N	POLYPACK P/N	DESCRIPTION	QTY
<b>WATERPROOF UTILITY LIGHT - 1 DIODE</b>			
LM112CB	LM112CBP	Waterproof mini utility light	50
<b>COURTESY LIGHT - 3 DIODES</b>			
LM315BB	LM315BBP	Courtesy light, black	50
<b>ACCENT LIGHT - 8 DIODE</b>			
LM835CB	LM835CBP	Recess mount accent light	50

<b>MATERIALS</b>	Polycarbonate lens and housing
<b>VOLT/AMP</b>	LM112CB: 12.8VDC - .013A LM315BB: 12.8VDC - .007A LM835CB: 12.8VDC - .087A
<b>WT/DIMS</b>	LM112CB: .154 lb. / 1.25" x 1.25" x 1.25" LM315BB: .187 lb. / 2.25" x 2.25" x 1.625" LM835CB: .210 lb. / 3.75" x 3.75" x 0.75"
<b>WARRANTY</b>	Lifetime LED Warranty

## ULL25 SERIES COB LED Utility Strip Light



- Waterproof
- Slim design - only 5/8" wide and 3/16" thick
- Design includes both lead and ground wire
- Ultrawhite – color temperature 6500K



BULK P/N	POLYPACK P/N	DESCRIPTION	QTY
<b>STRIP LIGHT - 76 COB</b>			
ULL25CB	ULL25CBP	12V COB strip light	50
ULL25CTB	ULL25CTBP	12V COB strip light with mounting tape	50
<b>Raw lumen output: 380 lm</b>			
<b>Effective lumen output: 220 lm</b>			

<b>MATERIALS</b>	Polycarbonate lens and housing
<b>VOLT/AMP</b>	12.8VDC - .30A
<b>WT/DIMS</b>	.25 lb. / 6.829" x .616" x 0.14"
<b>WARRANTY</b>	Lifetime LED Warranty



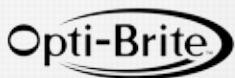

## TLL30 SERIES Opti-Brite™ LED Work Light

- Compact design – only 3.25" diameter
- Die cast aluminum housing with powder coat finish
- Stainless steel hardware
- 16-gauge, 20" lead and ground wire; IP69K rating



TLL30FB

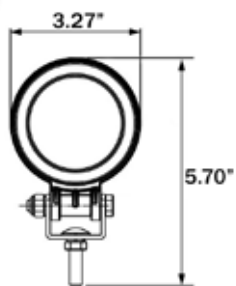

BULK P/N	POLYPACK P/N	DESCRIPTION	QTY
<b>FLOOD BEAM - 4 DIODES</b>			
TLL30FB	TLL30FBP	Flood beam	1t

**Raw lumen output: 960 lm**  
**Effective lumen output: 670 lm**

<b>MATERIALS</b>	Polycarbonate lens, aluminum housing
<b>VOLT/AMP</b>	12.8VDC - 0.75A, 24.0VDC - 0.37A
<b>WT/DIMS</b>	1.468 lbs. / 3.27" x 5.70" x 2.36"
<b>WARRANTY</b>	Lifetime LED Warranty

### IP69K RATING

Highest designation available for water ingress testing, offering increased reliability and service life when subjected to severe environmental conditions or cleaning methods.



## TLL44/45 SERIES Opti-Brite™ LED Work Lights

- Heavy duty design with powder coated, die cast aluminum housing and polycarbonate lens
- Low profile design – only 2 inches deep
- Dual power: use with 12VDC and 24VDC systems
- Stainless steel mounting hardware
- 14-gauge, 10” lead and ground wire

BULK P/N	POLYPACK P/N	DESCRIPTION	QTY
<b>ROUND LED WORK LIGHT - 6 DIODES</b>			
TLL44FB	TLL44FBP	Flood beam	2

<b>RETAIL</b>			
TLL144FSL		Flood beam, window box	3

**Raw lumen output: 1200 lm**  
**Effective lumen output: 720 lm**

<b>MATERIALS</b>	Polycarbonate lens, aluminum housing
<b>VOLT/AMP</b>	12.8VDC - 1.1A, 24.0VDC - 0.48A
<b>WT/DIMS</b>	0.98 lbs. / 4" x 6.281" x 2.375"
<b>WARRANTY</b>	Lifetime LED Warranty

BULK P/N	POLYPACK P/N	DESCRIPTION	QTY
<b>ROUND LED WORK LIGHT - 8 DIODES</b>			
TLL45FB	TLL45FBP	Flood beam	3

**Raw lumen output: 1600 lm**  
**Effective lumen output: 897 lm**

<b>MATERIALS</b>	Polycarbonate lens, aluminum housing
<b>VOLT/AMP</b>	12.8VDC - 1.38A, 24.0VDC - 0.65A
<b>WT/DIMS</b>	1.389 lbs. / 4.5" x 7" x 2"
<b>WARRANTY</b>	Lifetime LED Warranty



TLL144FSL

Opti-Brite



TLL44FB

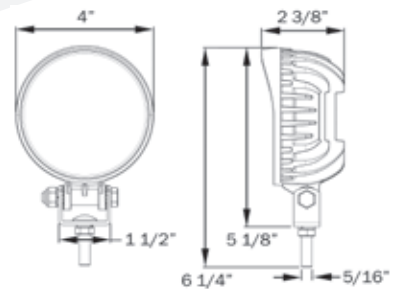

TLL45FB

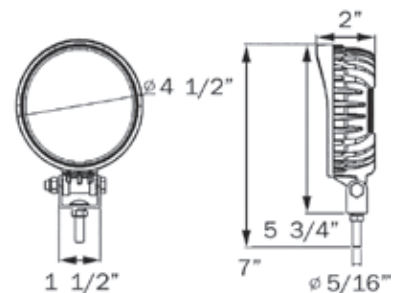

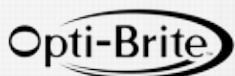

TLL46CFB



## TLL46 SERIES Opti-Brite™ LED Work Lights

- Heavy duty design with powder coated, die cast aluminum housing and polycarbonate lens
- Low profile design – less than 2.5 inches deep
- Dual power: use with 12VDC and 24VDC systems
- Stainless steel mounting hardware
- 14-gauge, 10" lead and ground wire

BULK P/N	POLYPACK P/N	DESCRIPTION	QTY
<b>FLOOD BEAM - 9 DIODES</b>			
TLL46CFB	TLL46CFBP	Flood beam	3
TLL46CFPG	-	Flood beam, .156 female barrel on ground, .156 male bullet on power	3
<b>Raw lumen output: 1800 lm</b>			
<b>Effective lumen output: 1042 lm</b>			



TLL46TB



<b>MATERIALS</b>	Polycarbonate lens, aluminum housing
<b>VOLT/AMP</b>	12.8VDC - 1.70A, 24.0VDC - 1.0A
<b>WT/DIMS</b>	1.764 lbs. / 5" x 7" x 2.375"
<b>WARRANTY</b>	Lifetime LED Warranty

BULK P/N	POLYPACK P/N	DESCRIPTION	QTY
<b>TRAPEZOID BEAM - 9 DIODES</b>			
TLL46TB	TLL46TBP	Trapezoid beam	3
<b>Raw lumen output: 1800 lm</b>			
<b>Effective lumen output: 707 lm</b>			

<b>MATERIALS</b>	Polycarbonate lens, aluminum housing
<b>VOLT/AMP</b>	12.8VDC - 1.50A, 24.0VDC - 0.73A
<b>WT/DIMS</b>	1.764 lbs. / 5" x 7" x 2.375"
<b>WARRANTY</b>	Lifetime LED Warranty

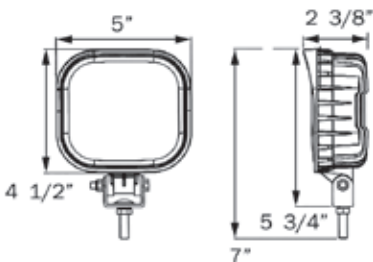

### IP69K RATING

Highest designation available for water ingress testing, offering increased reliability and service life when subjected to severe environmental conditions or cleaning methods.

## TLL48 SERIES Opti-Brite™ LED Work Light

- Heavy duty design with powder coated, die cast aluminum housing and polycarbonate lens
- Low profile design – less than 2.5 inches deep
- Dual power: use with 12VDC and 24VDC systems
- Stainless steel mounting hardware
- 14-gauge, 10" lead and ground wire; IP69K rating

BULK P/N	POLYPACK P/N	DESCRIPTION	QTY
<b>FLOOD BEAM - 6 DIODES</b>			
TLL48FB	TLL48FBP	Flood beam	5
<b>Raw lumen output: 1200 lm</b>			
<b>Effective lumen output: 617 lm</b>			
<b>MATERIALS</b>	Polycarbonate lens, aluminum housing		
<b>VOLT/AMP</b>	12.8VDC - 1.52A, 24.0VDC - 0.65A		
<b>WT/DIMS</b>	1.14 lbs. / 4.15" x 6.375" x 2.14"		
<b>WARRANTY</b>	Lifetime LED Warranty		

Opti-Brite



TLL48FB

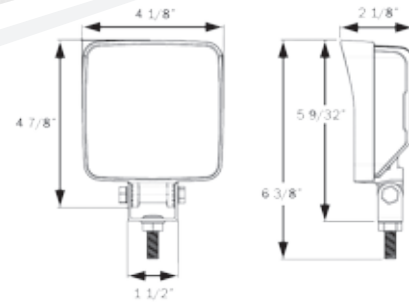

## TLL50 SERIES Opti-Brite™ LED Work Light

- Lightweight, compact LED work light
- Corrosion proof housing and polycarbonate lens
- Dual power: use with 12VDC and 24VDC systems
- 22-gauge, 10" lead and ground wire
- IP69K rating

BULK P/N	POLYPACK P/N	DESCRIPTION	QTY
<b>FLOOD BEAM - 9 DIODES</b>			
TLL50FB	TLL50FBP	Flood beam	3
<b>RETAIL</b>			
TLL150FSL		Flood beam, window box	1
<b>Raw lumen output: 324 lm</b>			
<b>Effective lumen output: 252 lm</b>			

Opti-Brite



TLL50FB

<b>MATERIALS</b>	Polycarbonate lens and housing, stainless steel hardware
<b>VOLT/AMP</b>	12.8VDC - 1.50A, 24.0VDC - 0.73A
<b>WT/DIMS</b>	1 lbs. / 4.938" x 6.938" x 2.375"
<b>WARRANTY</b>	Lifetime LED Warranty

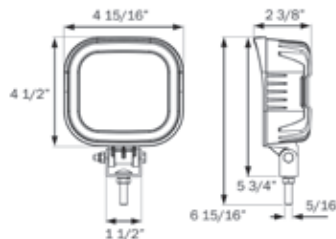

TLL150FSL

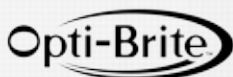

TLL51FB

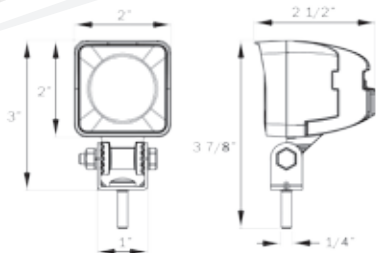

## TLL51 SERIES Opti-Brite™ LED Work Light

- Heavy duty design with powder coated, die cast aluminum housing and polycarbonate lens
- Compact design – only 2 inches square
- Dual power: use with 12VDC and 24VDC systems
- Stainless steel mounting hardware
- 14-gauge, 10" lead and ground wire; IP69K rating

BULK P/N	POLYPACK P/N	DESCRIPTION	QTY
<b>FLOOD BEAM - 1 DIODE</b>			
TLL51FB	TLL51FBP	Flood beam	10
TLL51FRPG	-	Flood beam, .180 male bullet on power, ring terminal on ground	10
<b>Raw lumen output: 800 lm</b>			
<b>Effective lumen output: 549 lm</b>			
<b>MATERIALS</b>	Polycarbonate lens, aluminum housing		
<b>VOLT/AMP</b>	12.8VDC - 0.91A, 24.0VDC - 0.42A		
<b>WT/DIMS</b>	0.37 lbs. / 2" x 3" x 2.5"		
<b>WARRANTY</b>	Lifetime LED Warranty		



TLL52FWB

TLL52FB



TLL152FSL

## TLL52 SERIES Opti-Brite™ LED Work Light

- Heavy duty design with powder coated, die cast aluminum housing and polycarbonate lens
- Compact design – only 2.75 inches square
- Dual power: use with 12VDC and 24VDC systems
- Stainless steel mounting hardware
- 14-gauge, 10" lead and ground wire; IP69K rating

BULK P/N	POLYPACK P/N	DESCRIPTION	QTY
<b>FLOOD BEAM - 3 DIODES</b>			
TLL52FB	TLL52FBP	Flood beam, black housing	10
TLL52FWB	TLL52FWBP	Flood beam, white housing	10
<b>RETAIL</b>			
TLL152FSL		Flood beam, window box	1
<b>Raw lumen output: 600 lm</b>			
<b>Effective lumen output: 325 lm</b>			
<b>MATERIALS</b>	Polycarbonate lens and housing, stainless steel hardware		
<b>VOLT/AMP</b>	12.8VDC - 1.50A, 24.0VDC - 0.73A		
<b>WT/DIMS</b>	.38 lbs. / 2.75" x 5.171" x 1.687"		
<b>WARRANTY</b>	Lifetime LED Warranty		

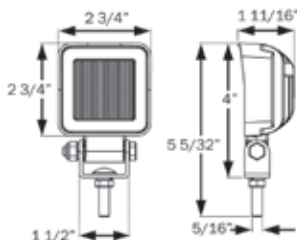

## TLL52 ABS SERIES Opti-Brite™ LED Work Light

- Corrosion proof housing and polycarbonate lens
- Compact design – only 2 inches square
- Dual power: use with 12VDC and 24VDC systems
- Stainless steel mounting hardware
- 14-gauge, 10" lead and ground wire; IP69K rating

BULK P/N	POLYPACK P/N	DESCRIPTION	QTY
<b>FLOOD BEAM - 3 DIODES</b>			
TLL52FPBB	TLL52FPBBP	Flood beam, blue housing	10
<b>Raw lumen output: 550 lm</b>			
<b>Effective lumen output: 389 lm</b>			

<b>MATERIALS</b>	Polycarbonate lens, nylon housing
<b>VOLT/AMP</b>	12.8VDC - .06A, 24.0VDC - 0.3A
<b>WT/DIMS</b>	0.37 lbs. / 2" x 3" x 2.5"
<b>WARRANTY</b>	Lifetime LED Warranty

Opti-Brite



TLL52FPBB

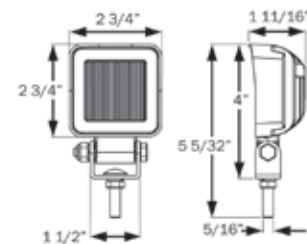

## TLL54 SERIES Opti-Brite™ LED Work Light

- Heavy duty design with powder coated, die cast aluminum housing and polycarbonate lens
- Low profile design – less than 2.5 inches deep
- Dual power: use with 12VDC and 24VDC systems
- Stainless steel mounting hardware
- 14-gauge, 10" lead and ground wire; IP69K rating

BULK P/N	POLYPACK P/N	DESCRIPTION	QTY
<b>SPOT BEAM - 9 DIODES</b>			
TLL54TB	TLL54TBP	Spot beam	5
<b>Raw lumen output: 1800 lm</b>			
<b>Effective lumen output: 900 lm</b>			

<b>MATERIALS</b>	Polycarbonate lens, aluminum housing
<b>VOLT/AMP</b>	12.8VDC - 1.50A, 24.0VDC - 0.73A
<b>WT/DIMS</b>	1.51 lbs. / 5" x 7" x 2.375"
<b>WARRANTY</b>	Lifetime LED Warranty

Opti-Brite



TLL54TB

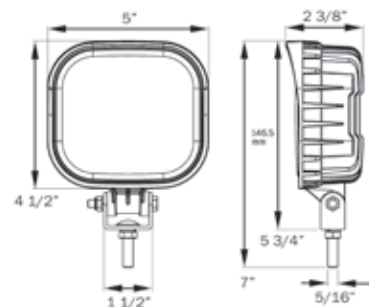

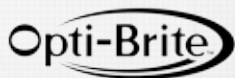

TLL55FB

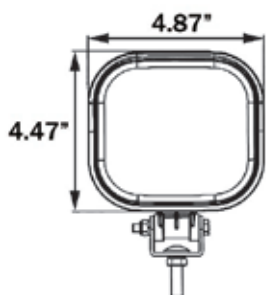

## TLL55 SERIES Opti-Brite™ LED Work Light

- Contoured lens for wide angle beam
- Die cast aluminum housing with powder coat finish
- Stainless steel hardware
- 14-gauge, 10" lead and ground wire; IP69K rating

BULK P/N	POLYPACK P/N	DESCRIPTION	QTY
<b>FLOOD BEAM - 9 DIODES</b>			
TLL55FB	TLL55FBP	Flood beam	1

**Raw lumen output: 2160 lm**  
**Effective lumen output: 1512 lm**

<b>MATERIALS</b>	Polycarbonate lens, aluminum housing
<b>VOLT/AMP</b>	12.8VDC - 1.50A, 24.0VDC - 0.73A
<b>WT/DIMS</b>	1.35 lbs. / 4.87" x 6.90" x 2.03"
<b>WARRANTY</b>	Lifetime LED Warranty



TLL56FB

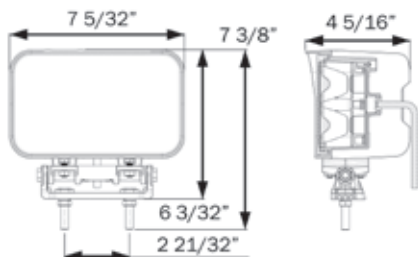

## TLL56/57 SERIES Opti-Brite™ LED Work Lights

- Heavy duty design with powder coated, die cast aluminum housing and polycarbonate lens
- Effective lumen output 4000 lumens
- Dual power: use with 12VDC and 24VDC systems
- Stainless steel mounting hardware
- 16-gauge, 20" lead and ground wire; IP69K rating

BULK P/N	POLYPACK P/N	DESCRIPTION	QTY
<b>FLOOD BEAM - 8 DIODES</b>			
TLL56FB	TLL56FBP	Flood beam	2
TLL57FB	TLL57FBP	Flood beam, shock mount	2

**Raw lumen output: 5600 lm**  
**Effective lumen output: 4000 lm**

<b>MATERIALS</b>	Polycarbonate lens, aluminum housing
<b>VOLT/AMP</b>	12.8VDC - 5.0A, 24.0VDC - 2.5A
<b>WT/DIMS</b>	3.53 lbs. / 7.161" x 9" x 4.313"
<b>WARRANTY</b>	Lifetime LED Warranty

## TLL60 SERIES Opti-Brite™ LED Work Light

- Heavy duty design with powder coated, die cast aluminum housing and polycarbonate lens
- Rectangular design – 6 inches wide by 2 inches high
- Dual power: use with 12VDC and 24VDC systems
- Stainless steel mounting hardware
- 14-gauge, 10" lead and ground wire; IP69K rating

BULK P/N	POLYPACK P/N	DESCRIPTION	QTY
<b>FLOOD BEAM - 6 DIODES</b>			
TLL60FB	TLL60FBP	Flood beam	5
<b>Raw lumen output: 1200 lm</b>			
<b>Effective lumen output: 720 lm</b>			

<b>MATERIALS</b>	Polycarbonate lens, aluminum housing
<b>VOLT/AMP</b>	12.8VDC - 1.1A, 24.0VDC - 0.48A
<b>WT/DIMS</b>	0.95 lbs. / 6" x 4.5" x 2.4"
<b>WARRANTY</b>	Lifetime LED Warranty

Opti-Brite



TLL60FB

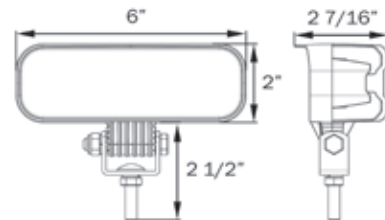

## TLL64 SERIES Opti-Brite™ LED Work Light

- Heavy duty design with powder coated, die cast aluminum housing and polycarbonate lens
- Ultrabright output in standard size light – 1939 lumens
- Dual power: use with 12VDC and 24VDC systems
- Stainless steel mounting hardware
- 14-gauge, 10" lead and ground wire; IP69K rating

BULK P/N	POLYPACK P/N	DESCRIPTION	QTY
<b>FLOOD BEAM - 4 DIODES</b>			
TLL64FB	TLL64FBP	Flood beam	2
<b>Raw lumen output: 3200 lm</b>			
<b>Effective lumen output: 1939 lm</b>			

<b>MATERIALS</b>	Polycarbonate lens, aluminum housing
<b>VOLT/AMP</b>	12.8VDC - 3.16A, 24.0VDC - 1.41A
<b>WT/DIMS</b>	1.41 lbs. / 4.187" x 6.5" x 3"
<b>WARRANTY</b>	Lifetime LED Warranty

Opti-Brite



TLL64FB

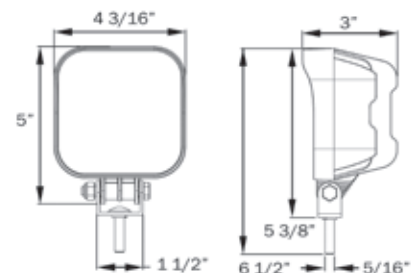



TLL70FB

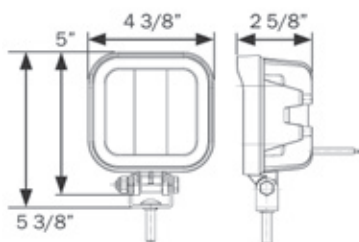

## TLL70 SERIES Opti-Brite™ LED Work Light

- Contoured lens for wide angle beam
- Heavy duty design with powder coated, die cast aluminum housing and polycarbonate lens
- Ultrabright output in standard size light – 2500 lumens
- Dual power: use with 12VDC and 24VDC systems
- Stainless steel mounting hardware
- 14-gauge, 10" lead and ground wire; IP69K rating

BULK P/N	POLYPACK P/N	DESCRIPTION	QTY
<b>FLOOD BEAM - 6 DIODES</b>			
TLL70FB	TLL70FBP	Flood beam	2
<b>Raw lumen output: 3950 lm</b>			
<b>Effective lumen output: 2500 lm</b>			
<b>MATERIALS</b>	Polycarbonate lens, aluminum housing		
<b>VOLT/AMP</b>	12.8VDC - 2.8A, 24.0VDC - 1.43A		
<b>WT/DIMS</b>	1.41 lbs. / 5" x 4.375" x 2.625"		
<b>WARRANTY</b>	Lifetime LED Warranty		



TLL71FB

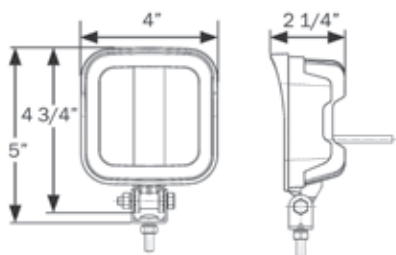

## TLL71 SERIES Opti-Brite™ LED Work Light

- Contoured lens for wide angle beam
- Heavy duty design with powder coated, die cast aluminum housing and polycarbonate lens
- Dual power: use with 12VDC and 24VDC systems
- Stainless steel mounting hardware
- 14-gauge, 10" lead and ground wire; IP69K rating

BULK P/N	POLYPACK P/N	DESCRIPTION	QTY
<b>FLOOD BEAM - 9 DIODES</b>			
TLL71FB	TLL71FBP	Flood beam	2
<b>Raw lumen output: 1560 lm</b>			
<b>Effective lumen output: 938 lm</b>			
<b>MATERIALS</b>	Polycarbonate lens, aluminum housing		
<b>VOLT/AMP</b>	12.8VDC - 1.43A, 24.0VDC - 0.66A		
<b>WT/DIMS</b>	1.41 lbs. / 4.75" x 4" x 2.25"		
<b>WARRANTY</b>	Lifetime LED Warranty		



## TLL72 SERIES

### Opti-Brite™ LED Work Light

- Contoured lens for wide angle beam
- Heavy duty design with powder coated, die cast aluminum housing and polycarbonate lens
- Dual power: use with 12VDC and 24VDC systems
- Stainless steel mounting hardware
- 14-gauge, 10" lead and ground wire; IP69K rating



TLL72FB

BULK P/N	POLYPACK P/N	DESCRIPTION	QTY
<b>FLOOD BEAM - 9 DIODES</b>			
TLL72FB	TLL72FBP	Flood beam	2

**Raw lumen output:** 1610 lm  
**Effective lumen output:** 980 lm

<b>MATERIALS</b>	Polycarbonate lens, aluminum housing
<b>VOLT/AMP</b>	12.8VDC - 1.48A, 24.0VDC - 0.7A
<b>WT/DIMS</b>	1.5 lbs. / 5.375" x 5" x 2.25"
<b>WARRANTY</b>	Lifetime LED Warranty

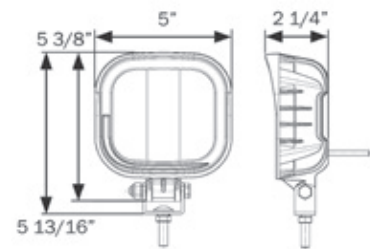

## TLL73 SERIES

### Opti-Brite™ LED Work Light

- Heavy duty design with powder coated, die cast aluminum housing and polycarbonate lens
- Dual power: use with 12VDC and 24VDC systems
- Stainless steel mounting hardware; built in handle
- 14-gauge, 10" lead and ground wire; IP69K rating



TLL73FB

BULK P/N	POLYPACK P/N	DESCRIPTION	QTY
<b>FLOOD BEAM - 9 DIODES</b>			
TLL73FB	TLL73FBP	Flood beam	2

**Raw lumen output:** 1610 lm  
**Effective lumen output:** 980 lm

<b>MATERIALS</b>	Polycarbonate lens, aluminum housing
<b>VOLT/AMP</b>	12.8VDC - 1.48A, 24.0VDC - 0.7A
<b>WT/DIMS</b>	1.61 lbs. / 7.5" x 5" x 3.25"
<b>WARRANTY</b>	Lifetime LED Warranty

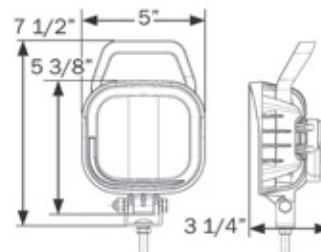

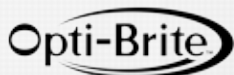

## TLL80 SERIES Opti-Brite™ LED Mini Flood Light



TLL80FB

- Coated die cast aluminum housing, polycarbonate lens
- Compact design – only 3 inches wide by 2 inches high
- Bright white SMD diodes for bright, dependable light

BULK P/N	POLYPACK P/N	DESCRIPTION	QTY
<b>FLOOD BEAM - 6 DIODES</b>			
TLL80FB	TLL80FBP	Flood beam, black housing	5
TLL80WFB	TLL80WFBP	Flood beam, white housing	5

**Raw lumen output: 270 lm**

**Effective lumen output: 150 lm**

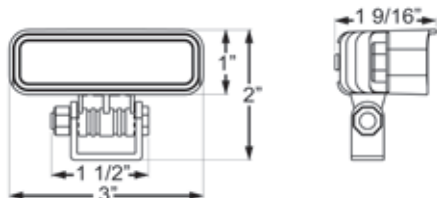

<b>MATERIALS</b>	Polycarbonate lens, aluminum housing
<b>VOLT/AMP</b>	12.8VDC - .19A
<b>WT/DIMS</b>	.7 lbs. / 3" x 2" x 1.563"
<b>WARRANTY</b>	Lifetime LED Warranty



## DLL25/50 SERIES LED Docking/Utility Lights



DLL50CB



DLL50WC

- Wide, low beam ideal for docking or loading applications
- Die cast aluminum housing coated for protection against corrosion and UV exposure; durable polycarbonate lens
- Sealed lens, gasket at wire entry; IP44 rating
- Dual power: use with 12VDC and 24VDC systems
- Stainless steel mounting hardware
- 20-gauge lead and ground wire with tinned ends

BULK P/N	POLYPACK P/N	DESCRIPTION	QTY
<b>DOCKING/UTILITY LIGHTS - 2 DIODES</b>			
DLL50CB	DLL50CBP	Black housing	10
<b>RETAIL</b>			
TLL25FS		Black housing, clam	3
DLL50CC		Pair of lights, black housing, box	3
DLL50WC		Pair of lights, white housing, box	3

**Raw lumen output: 440 lm**  
**Effective lumen output: 396 lm**

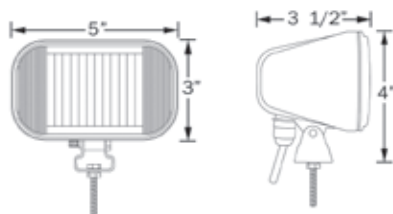

<b>MATERIALS</b>	Polycarbonate lens, aluminum housing
<b>VOLT/AMP</b>	12.8/24.0VDC - 0.683A
<b>WT/DIMS</b>	DLL50CB: 1.23 lbs. / 5" x 4" x 3.5"
	DLL50CC/WC: 3.00 lbs. / 5" x 4" x 3.5"
<b>WARRANTY</b>	Lifetime LED Warranty

## ST45 SERIES 4" Round Sealed Lights

- Sonically sealed, waterproof
- Shock-proof socket guarantees long bulb life
- Accepts standard PL-3 plug
- Kits include grommet and plug



ST45RB





ST45AB



ST46RB

SEALED STOP/TURN/TAILO  
PARKING/TURN SIGNALS

BULK P/N	POLYPACK P/N	DESCRIPTION	QTY
<b>RED STOP/TURN/TAIL LIGHTS</b>			
ST45RB	ST45RBP	Light with PL-3 connection	50
ST44RB	ST44RBP	Kit: ST45RB, A45GB & A45PB	10
ST45RGB	ST45RGBP	Light with male pin connection	50
ST46RB	ST46RBP	Light with reflex lens, PL-3 connection	50
<b>YELLOW PARKING/TURN SIGNALS</b>			
ST45AB	ST45ABP	Light	50
ST44AB	ST44ABP	Kit: ST45AB, A45GB & A45PB	10
<b>ACCESSORIES</b>			
A45GB	A45GBP	Grommet	50
A45PB	A45PBP	Pigtail, 3-wire	100
A47PB	A47PBP	Right angle pigtail, 3-wire	100
BK45BB	BK45BBP	Black steel bracket	10
<b>RETAIL</b>			
ST45RK		Kit: ST45RB, A45GB & A45PB, clam	6
ST45RS		Light only, clam	6

<b>FMVSS</b>	ST45RB: S T I P 2 ST45AB: I P P 2 ST46RB: S T I P 2 A
<b>MATERIALS</b>	Polycarbonate lens and housing
<b>VOLT/AMP</b>	12.8VDC - 2.4A Stop/Turn, 0.49A Tail/Parking
<b>WT/DIMS</b>	ST45/46: .221 lbs. / 4.25" x 4.25" x 2.063"
<b>WARRANTY</b>	Three Year Warranty



ST45RGB male pin connection detail

HOLE CUT-OUT:  
4.5"

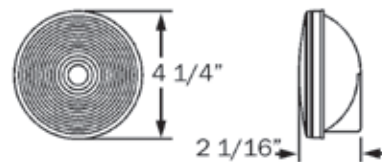

ST45AB/RB & 46RB



## ST47 Series 4" Flange Mount Stop/Turn/Tail Light

### PATENTED TECHNOLOGY

- Sonically sealed, waterproof
- ST47RLB includes locking connection designed to retain straight PL-3 plugs found on existing wire harnesses
- Shock-proof socket guarantees long bulb life



ST47RB



ST47RLB

SEALED STOP/TURN/TAILO  
PARKING/TURN SIGNALS

BULK P/N	POLYPACK P/N	DESCRIPTION	QTY
<b>RED STOP/TURN/TAIL LIGHT</b>			
ST47RB	ST47RBP	Flange mount, PL-3 connection, gray	50
ST47RKB	ST47RKBP	Kit: ST47RB & A45PB	10
ST47RLB	ST47RLBP	Flange mount, locking PL-3 connection, black	50

<b>FMVSS</b>	S T I P 2
<b>MATERIALS</b>	Polycarbonate lens and housing
<b>VOLT/AMP</b>	12.8VDC - 2.4A Stop/Turn, .49A Tail
<b>WT/DIMS</b>	.617 lbs. / 5.50" x 5.50" x 2"
<b>WARRANTY</b>	Three Year Warranty

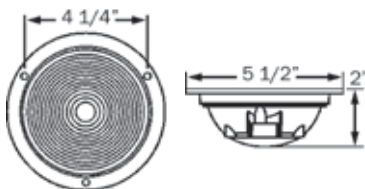

HOLE CUT-OUT: 4.5"



Locking Connection

## ST70/75 SERIES 6" Oval Sealed Lights

- Sonically sealed, waterproof
- Shock-proof socket guarantees long bulb life
- Accepts standard PL-3 plug
- Kits include grommet and plug

BULK P/N	POLYPACK P/N	DESCRIPTION	QTY
<b>RED STOP/TURN/TAIL LIGHTS</b>			
ST70RB	ST70RBP	Light	50
ST74RB	ST74RBP	Kit: ST70RB, A70GB & A45PB	50
ST70RBTK	ST70RBTKP	ST70RB light sealed to bracket	30
ST64RB	ST64RBP	Kit: ST70RB, A70GB & A47PB (plug attached to light)	50
ST65RB	ST65RBP	Kit: ST70RB, A70GB & A47PB	50
<b>YELLOW SIGNAL LIGHTS</b>			
ST70AB	ST70ABP	Parking/turn signal	50
ST74AB	ST74ABP	Kit: ST70AB, A70GB & A45PB	50
ST75AB	ST75ABP	Mid-ship turn signal/side marker	50
ST77AB	ST77ABP	Kit: ST75AB, A70GB & A45PB	50
<b>ACCESSORIES</b>			
A70GB	A70GBP	Grommet	50
A45PB	A45PBP	Pigtail, 3-wire	100
A47PB	A47PBP	Right angle pigtail, 3-wire	100
BK70BB	BK70BBP	Black steel bracket	10
<b>RETAIL</b>			
ST70RK		Kit: ST70RB, A70GB & A45PB, clam	6
ST70RS		Light only, clam	6

<b>FMVSS</b>	ST70RB: S T I P 2 ST70AB: I P P 2 ST75AB: E P 2 A
<b>MATERIALS</b>	Polycarbonate lens and housing
<b>VOLT/AMP</b>	12.8VDC - 2.4A Stop/Turn, 0.50A Tail/Parking
<b>WT/DIMS</b>	ST70: .265 lb. / 6.5" x 2.313" x 2.375" ST75: .221 lbs. / 6.5" x 2.313" x 2.75"
<b>WARRANTY</b>	Three Year Warranty

**optronics**



ST70RB



ST70RBTK



ST70AB



ST75AB

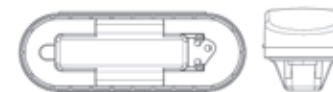
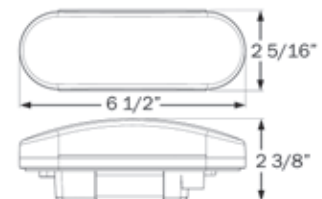

ST70

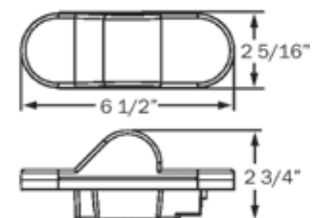

ST75AB

HOLE CUT-OUT: 6.85" X 2.5" (1.25" R)

SEALED STOP/TURN/TAIL & PARKING/TURN SIGNALS



## ST33 SERIES Rectangular Sealed Lights

- Sonically sealed, waterproof
- Shock-proof socket guarantees long bulb life
- Accepts standard PL-3 plug
- Kits include grommet and plug



ST33RB



ST33AB

SEALED STOP/TURN/TAIL & PARKING/TURN SIGNALS

BULK P/N	POLYPACK P/N	DESCRIPTION	QTY
<b>RED STOP/TURN/TAIL LIGHTS</b>			
ST33RB	ST33RBP	Light	10
ST34RB	ST34RBP	Kit: ST33RB, A33GB & A47PB	50
<b>YELLOW PARKING/TURN LIGHTS</b>			
ST33AB	ST33ABP	Light	10
<b>ACCESSORIES</b>			
A33GB	A33GBP	Grommet	50
A45PB	A45PBP	Pigtail, 3-wire	100
A47PB	A47PBP	Right angle pigtail, 3-wire	100

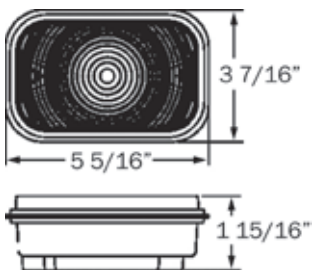

HOLE CUT-OUT: 5.453" X 3.578" (1" R)

FMVSS	ST33RB: S T I P2 ST33AB: I P P2
MATERIALS	Polycarbonate lens and housing
VOLT/AMP	12.8VDC - 2.19A Stop/Turn, 0.49A Tail/Parking
WT/DIMS	.265 lb. / 5.313" x 3.438" x 1.938"
WARRANTY	Three Year Warranty

## ST40/42 SERIES Flush Mount Stop/Turn/Tail Lights



- Flush mount with acrylic lens, steel housing, gasket
- Replaceable lens and bulb
- Shock-proof socket guarantees long bulb life
- Hard wired



ST40RB

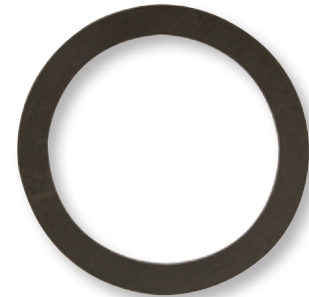

A42GB

BULK P/N	POLYPACK P/N	DESCRIPTION	QTY
<b>RED STOP/TURN/TAIL LIGHTS</b>			
ST40RB	ST40RBP	Light, self grounding	50
ST42RB	ST42RBP	Light with reflex, ground wire	50
ST42RPG	ST42RPGP	Light with reflex, ground wire, .180 male bullets	50
<b>ACCESSORIES</b>			
A40SRB	A40SRBP	Snap-in lens retention ring	100
A40RB	A40RBP	Red lens	25
A42GB	A42GBP	Gasket for flange	100
A43RB	A43RB	Red lens with reflex	25
A2057B	A2057BP	2057 bulb	50
<b>RETAIL</b>			
ST40RS		Light, clam	6

COMBINATION  
TAIL LIGHTS & KITS

<b>FMVSS</b>	ST40: S T I ST42: A I S T
<b>MATERIALS</b>	Acrylic lens, steel housing
<b>VOLT/AMP</b>	12.8VDC - 2.4A Stop/Turn, 0.49A Tail/Parking
<b>WT/DIMS</b>	.221 lbs. / 5.375" x 5.375" x 1.563"
<b>WARRANTY</b>	Three Year Warranty

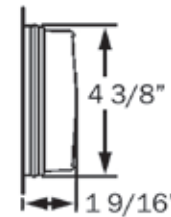
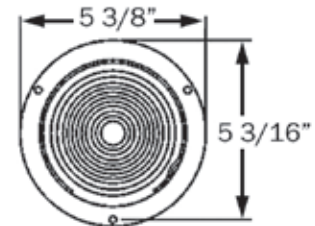

HOLE CUT-OUT: 4.5"



## ST90 SERIES 7" Transit Lights for Surface Mount

- Screw-on lens, easy to change bulb
- Surface mount on 6-1/4" centers
- Grounds through mounting hardware
- Acrylic lens, steel base plate

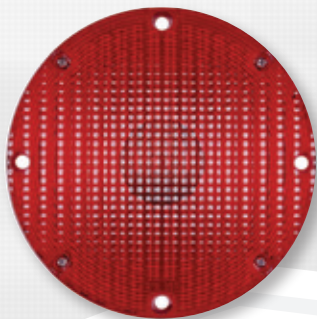

ST90RB

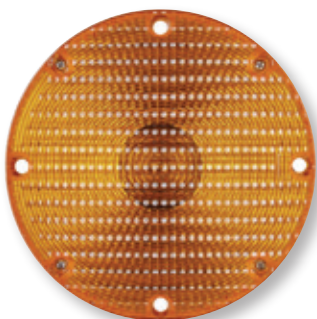

ST90AB

COMBINATION  
TAIL LIGHTS & KITS

BULK P/N	POLYPACK P/N	DESCRIPTION	QTY
<b>RED STOP/TAIL LIGHTS</b>			
ST90RB	ST90RBP	Light, 1157 bulb	5
<b>YELLOW TURN SIGNAL</b>			
ST90AB	ST90ABP	Light, 1156 bulb	5
<b>ACCESSORIES</b>			
A90RB	A90RBP	Red lens	5
A90AB	A90ABP	Yellow lens	5
A1157B	A1157BP	1157 replacement bulb	50
A1156B	A1156BP	1156 replacement bulb	50

<b>FMVSS</b>	Red: S T I, Yellow: I
<b>MATERIALS</b>	Acrylic lens and steel housing
<b>VOLT/AMP</b>	12.8VDC - 2.4A Stop, 0.5A Tail/Parking
<b>WT/DIMS</b>	1.146 lbs. / 7.125" x 7.125" x 2.188"
<b>WARRANTY</b>	Three Year Warranty

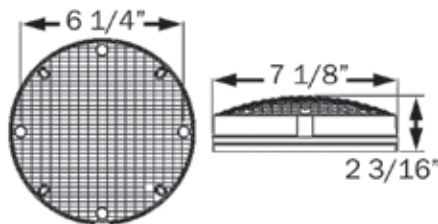



## ST92 SERIES

### 7" Transit Warning Lights for Surface Mount

- School bus warning lamps
- Screw-on lens, easy to change halogen bulb
- Hard wired, includes lead and ground wire
- Acrylic lens, steel base plate

BULK P/N	POLYPACK P/N	DESCRIPTION	QTY
<b>RED WARNING LIGHT</b>			
ST92RB	ST92RBP	Warning light	5
<b>YELLOW WARNING LIGHT</b>			
ST92AB	ST92ABP	Warning light	5
<b>ACCESSORIES</b>			
A94VB	A94VBP	Black visor	25
<b>RETAIL</b>			
A700		12V H3 55W replacement bulb, clam	12

FMVSS	W W2
MATERIALS	Acrylic lens and steel housing
VOLT/AMP	12.8VDC - 4.6A
WT/DIMS	1.146 lbs. / 7.063" x 7.063" x 2.25"
WARRANTY	Three Year Warranty

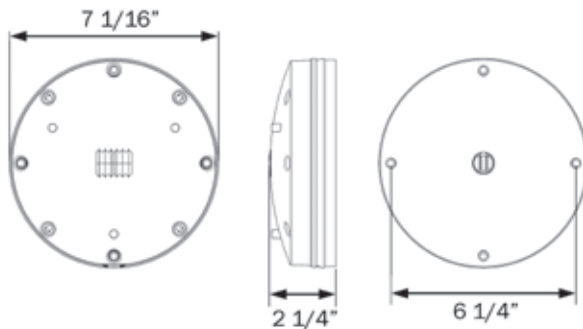

**optronics**



ST92RB



ST92AB



A94VB

COMBINATION  
TAIL LIGHTS & KITS



## ST51/52/53 SERIES Pedestal Mount Lights

- Snap-on lens, easy to change bulb
- ST51/52 mount with single post and are self grounding; ST53 with dual post mounts on 2" centers and includes ground wire



ST51RB



ST52AA



ST52RB



ST53AAB

BULK P/N	POLYPACK P/N	DESCRIPTION	QTY
<b>RED - SINGLE FACE</b>			
ST51RB	ST51RBP	Red, single face	10
<b>YELLOW - DUAL FACE</b>			
-	ST52AAP	Yellow, dual face	10
ST53AAB	ST53AABP	Square, yellow dual face with side marker/reflex, 1156 bulb	10
<b>RED/YELLOW DUAL FACE</b>			
ST52RB	ST52RBP	Dual face yellow/red stop/turn/tail light	10
<b>ACCESSORIES</b>			
A52RB	A52RBP	Red lens, round	25
A52AB	A52ABP	Yellow lens, round	25
A2057B	A2057BP	2057 replacement bulb	50
<b>RETAIL</b>			
ST51RS		Red stop/turn/tail light, clam	6
ST52AA		Dual yellow/yellow parking/turn, clam	6
ST52RA		Dual yellow/red stop/turn/tail light, clam	6



ST51/52

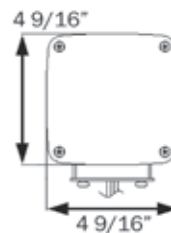

ST53AAB

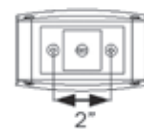

COMBINATION  
TAIL LIGHTS & KITS

## ST24/25 SERIES

### Stud Mount Stop/Turn/Tail Lights

- Snap-on lens, easy to change bulb
- Stud mount on 2" centers
- Grounds through mounting hardware
- Acrylic lens, corrosion proof plastic housing
- Driver side light includes license illuminator

BULK P/N	POLYPACK P/N	DESCRIPTION	QTY
<b>STOP/TURN/TAIL LIGHTS</b>			
ST24RB	ST24RBP	Passenger side light	50
ST25RB	ST25RBP	Driver side light with license illuminator	50
<b>ACCESSORIES</b>			
A24RB	A24RBP	Red lens	25
A2057B	A2057BP	2057 replacement bulb	50

<b>FMVSS</b>	ST24RB: S T I P, ST25RB: S T I P L
<b>MATERIALS</b>	Acrylic lens and plastic housing
<b>VOLT/AMP</b>	12.8VDC - 2.5A Stop/Turn, 1.0A Tail
<b>WT/DIMS</b>	.309 lb. / 4.313" x 4.313" x 3.375"
<b>WARRANTY</b>	Three Year Warranty

**Optronics**

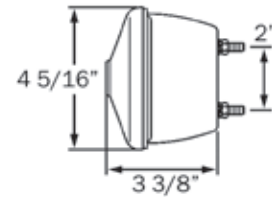
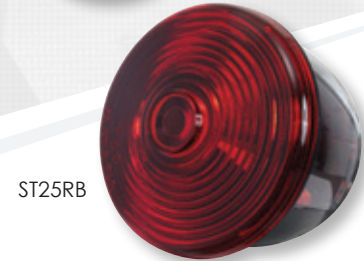

COMBINATION  
TAIL LIGHTS & KITS

## ST20/21 SERIES

### Surface Mount Stop/Turn/Tail Lights

- Screw-on lens, easy to change bulb
- Surface mount on 2" centers
- Grounds through mounting hardware
- Acrylic lens, steel housing
- Driver side light includes license illuminator

BULK P/N	POLYPACK P/N	DESCRIPTION	QTY
<b>RETAIL</b>			
ST20RS		Passenger side, clam	6
ST21RS		Driver side, clam	6
A20R		Red lens, slipover blister	12
<b>ACCESSORIES</b>			
A1157B	A1157BP	1157 replacement bulb	50

<b>FMVSS</b>	ST20RS: S T I, ST21RS: S T I L
<b>MATERIALS</b>	Acrylic lens and steel housing
<b>VOLT/AMP</b>	12.8VDC - 2.3A Stop/Turn, 0.90A Tail
<b>WT/DIMS</b>	.551 lb. / 3.875" x 3.875" x 3.063"
<b>WARRANTY</b>	Three Year Warranty

**Optronics**

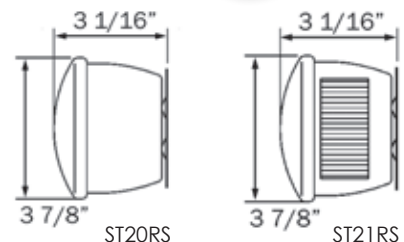



## ST8/9 SERIES Universal Mount Combination Tail Lights

- Screw-on lens, easy to change bulbs
- Stud mount on 2" centers
- Grounds through mounting studs
- Shock-proof socket guarantees long bulb life
- Acrylic lens, corrosion proof plastic housing
- Passenger side light is 6-function: stop, turn, tail, rear reflex, side marker, and side reflex
- Driver side light also includes license illuminator
- Bulk models are designed with Plug-n-go connections for quick connect wiring
- Retail models are hard wired, self grounding



ST9RB



ST8RB



TL8RK

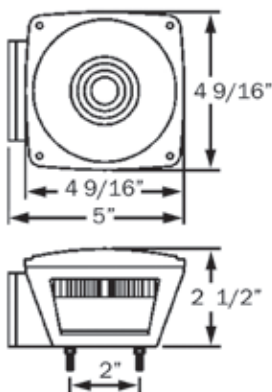

COMBINATION  
TAIL LIGHTS & KITS

BULK P/N	POLYPACK P/N	DESCRIPTION	QTY
----------	--------------	-------------	-----

### STOP/TURN/TAIL LIGHTS

ST8RB	ST8RBP	Passenger side light	50
ST9RB	ST9RBP	Driver side light with license illuminator	50
ST8RHB	-	Passenger side light, hard wired	50
ST9RHB	-	Driver side light, hard wired	50
TL27BK	-	Kit: ST8RB, ST9RB, (2) MC36AB amber marker lights with reflex, LP10SB license plate bracket; 20-ft harness, box	1
TL29BK	-	Kit: ST8RB, ST9RB, (2) MC36AB amber marker lights with reflex, LP10SB license plate bracket; 25-ft harness, box	1

### ACCESSORIES

A8RB	A8RBP	Tail light lens	50
A9RB	A9RBP	Side marker light lens	50
A1157B	A1157BP	1157 replacement bulb	50

### RETAIL

ST8RS		Passenger side light, clam	6
ST9RS		Driver side with license illuminator, clam	6
TL8RK		Kit: ST8RB, ST9RB, license plate bracket, 20-ft harness, mounting hardware, clam	2
A8RK		Tail and side marker lens set, clam	12
A8R		Tail light lens, clam	12
A9R		Side marker light lens, clam	12

<b>FMVSS</b>	ST8RB: A S T, A P2, ST9RB: A S T, A P2, L
<b>MATERIALS</b>	Acrylic lens and plastic housing
<b>VOLT/AMP</b>	12.8VDC - 2.5A Stop/Turn, 1.0A Tail
<b>WT/DIMS</b>	.309 lb. / 4.563" x 4.563" x 2.875"
<b>WARRANTY</b>	Three Year Warranty

## ST6/7 SERIES

### Submersible Universal Mount Combination Tail Lights

- Submersible design suitable for many applications
- Screw-on lens, easy to change bulbs
- Stud mount on 2" centers
- Grounds through mounting studs
- Shock-proof socket guarantees long bulb life
- Acrylic lens, corrosion proof plastic housing
- Passenger side light is 6-function: stop, turn, tail, rear reflex, side marker, and side reflex
- Driver side light also includes license illuminator



ST7RB



ST6RB



TL5RK



BULK P/N	POLYPACK P/N	DESCRIPTION	QTY
<b>STOP/TURN/TAIL LIGHTS</b>			
ST6RB	ST6RBP	Passenger side light	50
ST7RB	ST7RBP	Driver side light with license illuminator	50
ST6RPG	ST6RPGP	Passenger side light, 2-way plug	50
ST7RPG	ST7RPGP	Driver side light with license illuminator, 2-way plug	50
<b>ACCESSORIES</b>			
A8RB	A8RBP	Tail light lens	50
A9RB	A9RBP	Side marker light lens	25
A1157B	A1157BP	1157 replacement bulb	50
<b>RETAIL</b>			
ST6RS		Passenger side light, clam	6
ST7RS		Driver side with license illuminator, clam	6
TL5RK		Deluxe kit: ST6RB, ST7RB, (2) MC36AB amber marker lights with reflex, LP10SB license plate bracket, 25-ft harness, mounting hardware, clam	2
TL9RK		Kit: ST6RB, ST7RB, LP10SB license plate bracket, 25-ft harness, mounting hardware, clam	2
A8RK		Tail and side marker lens set, clam	12
A8R		Tail light lens, clam	12
A9R		Side marker light lens, clam	12
<b>FMVSS</b>	ST6RB: A S T, A P2, ST7RB: A S T, A P2, L		
<b>MATERIALS</b>	Acrylic lens and plastic housing		
<b>VOLT/AMP</b>	12.8VDC - 2.5A Stop/Turn, 1.0A Tail		
<b>WT/DIMS</b>	.309 lb. / 4.563" x 4.563" x 2.875"		
<b>WARRANTY</b>	Three Year Warranty		

COMBINATION TAIL LIGHTS & KITS

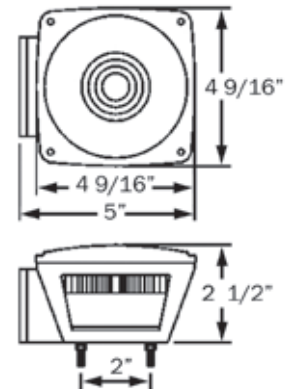



## ST2/3 SERIES

### Universal Mount Combination Tail Lights for Over 80" Applications



ST3RB



ST2RB

- Screw-on lens, easy to change bulbs
- Stud mount on 2" centers
- Grounds through mounting studs
- Shock-proof socket guarantees long bulb life
- Acrylic lens, corrosion proof plastic housing
- Passenger side light is 7-function: stop, turn, tail, rear clearance, rear reflex, side marker, and side reflex
- Driver side light also includes license illuminator
- Designed with Plug-n-go connections for quick connect wiring

COMBINATION  
TAIL LIGHTS & KITS

BULK P/N	POLYPACK P/N	DESCRIPTION	QTY
<b>STOP/TURN/TAIL LIGHTS</b>			
ST2RB	ST2RBP	Passenger side light	50
ST3RB	ST3RBP	Driver side light with license illuminator	50
<b>ACCESSORIES</b>			
A8RB	A8RBP	Tail light lens	50
A2RB	A2RBP	Side marker light lens	25
A1157B	A1157BP	1157 replacement bulb	50

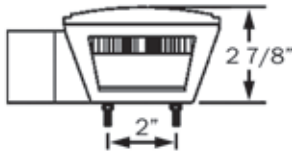
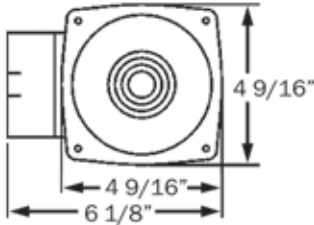

<b>FMVSS</b>	ST2RB: S T I A, P2 PC A, ST3RB: S T I A, P2 PC A, L
<b>MATERIALS</b>	Acrylic lens and plastic housing
<b>VOLT/AMP</b>	12.8VDC - 2.5A Stop/Turn, 1.0A Tail
<b>WT/DIMS</b>	.441 lb. / 6.125" x 4.563" x 2.875"
<b>WARRANTY</b>	Three Year Warranty

## ST4/5 SERIES

### Submersible Universal Mount Combination Tail Lights for Over 80" Applications

- Submersible design suitable for many applications
- Screw-on lens, easy to change bulbs
- Stud mount on 2" centers
- Grounds through mounting studs
- Shock-proof socket guarantees long bulb life
- Acrylic lens, corrosion proof plastic housing
- Passenger side light is 7-function: stop, turn, tail, rear clearance, rear reflex, side marker, and side reflex
- Driver side light also includes license illuminator

**optronics**



ST5RB



ST4RB

BULK P/N	POLYPACK P/N	DESCRIPTION	QTY
<b>STOP/TURN/TAIL LIGHTS</b>			
ST4RB	ST4RBP	Passenger side light	50
ST5RB	ST5RBP	Driver side light with license illuminator	50
<b>ACCESSORIES</b>			
A8RB	A8RBP	Tail light lens	50
A2RB	A2RBP	Side marker light lens	25
A1157B	A1157BP	1157 replacement bulb	50
<b>RETAIL</b>			
ST4RS		Passenger side light, clam	6
ST5RS		Driver side with license illuminator, clam	6
TL60RK		Set: ST4RB, ST5RB, mounting hardware, clam	2
A8R		Tail light lens, clam	12

<b>FMVSS</b>	ST6RB: S T I A, A P2, ST7RB: S T I A, A P2, L
<b>MATERIALS</b>	Acrylic lens and plastic housing
<b>VOLT/AMP</b>	12.8VDC - 2.5A Stop/Turn, 1.0A Tail
<b>WT/DIMS</b>	.441 lb. / 6.125" x 4.563" x 2.875"
<b>WARRANTY</b>	Three Year Warranty



TL60RK

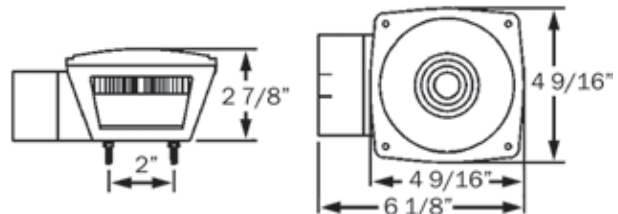

COMBINATION  
TAIL LIGHTS & KITS



## ST16/17 SERIES Waterproof Universal Mount Combination Tail Lights

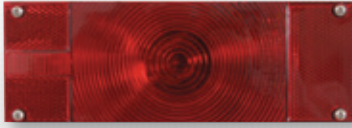

ST17RB

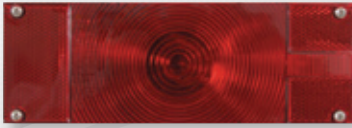

ST16RB



TL16RK



TL15RK

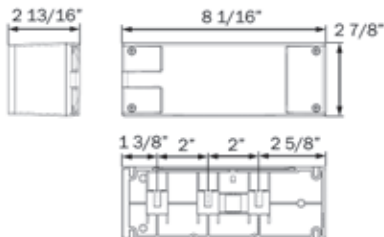

- Waterproof, low profile design for marine applications
- Replaceable lenses and bulbs
- Mount on 2" centers
- Includes separate ground wire with eyelet
- Acrylic lens, corrosion proof plastic housing
- Passenger side light is 7-function: stop, turn, tail, rear clearance, rear reflex, side marker, and side reflex
- Driver side light also includes license illuminator

BULK P/N	POLYPACK P/N	DESCRIPTION	QTY
----------	--------------	-------------	-----



### STOP/TURN/TAIL LIGHTS

ST16RB	ST16RBP	Passenger side light	20
ST17RB	ST17RBP	Driver side light with license illuminator	20
ST26RPG	ST26RPGP	Passenger side light, self grounding, 2-way plug	20
ST27RPG	ST27RPGP	Driver side light with license illuminator, self grounding, 2-way plug	20

### ACCESSORIES

A16RB	A16RBP	Tail light lens	50
A17RB	A17RBP	Side marker light lens	50
A2057B	A2057BP	2057 replacement bulb	50

### RETAIL

ST16RS		Passenger side light, clam	6
ST17RS		Driver side with license illuminator, clam	6
TL16RK		Deluxe kit: ST16RB, ST17RB, LP10SB license plate bracket, (2) MC91AB yellow marker lights with bases, (2) RE11AB yellow reflectors, 25-ft harness, stainless steel mounting hardware, clam	2
TL15RK		Kit: ST16RB, ST17RB, LP10SB license plate bracket, 25-ft harness, mounting hardware, clam	2
A16R		Tail light lens, clam	12

<b>FMVSS</b>	ST16RB: S T I A P2 PC; ST17RB: S T I A P2 PC, L
<b>MATERIALS</b>	Acrylic lens and plastic housing
<b>VOLT/AMP</b>	12.8VDC - 2.3A Stop/Turn, 0.9A Tail
<b>WT/DIMS</b>	.661 lb. / 8.063" x 2.875" x 2.813"
<b>WARRANTY</b>	Three Year Warranty



## ST36/37 SERIES

### Waterproof Universal Mount Combination Tail Lights

- Waterproof, low profile design for marine applications
- Screw-on lens, easy to change bulbs
- Mount on 2" centers
- Includes separate ground wire with eyelet
- Shock-proof socket guarantees long bulb life
- Acrylic lens, corrosion proof plastic housing
- Passenger side light is 7-function: stop, turn, tail, rear clearance, rear reflex, side marker, and side reflex
- Driver side light also includes license illuminator
- Stainless steel mounting hardware

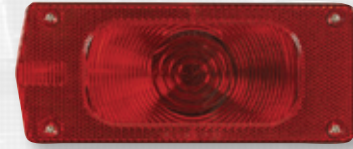

ST37RB



ST36RB



TL36RK

BULK P/N	POLYPACK P/N	DESCRIPTION	QTY
<b>STOP/TURN/TAIL LIGHTS</b>			
ST36RB	ST36RBP	Passenger side light	20
ST37RB	ST37RBP	Driver side light with license illuminator	20
ST36RPG	ST36RPGP	Passenger side light, self grounding, 2-way plug	20
ST37RPG	ST37RPGP	Driver side light with license illuminator, self grounding, 2-way plug	20
ST66RPG	ST66RPGP	Passenger side light, 3-way plug	20
ST67RPG	ST67RPGP	Driver side light with license illuminator, 3-way plug	20
<b>ACCESSORIES</b>			
A39RB	A39RBP	Tail light lens	10
A37RB	A37RBP	Side marker light lens	50
A1157B	A1157BP	1157 replacement bulb	50
<b>RETAIL</b>			
ST36RS		Passenger side light, clam	6
ST37RS		Driver side with license illuminator, clam	6
TL36RK		Deluxe kit: ST36RB, ST37RB, LP10SB license plate bracket, (2) MC91AB yellow marker lights with bases, 25-ft harness, stainless steel mounting hardware, clam	2
A36R		Tail and marker light lenses, clam	12
<b>FMVSS</b>	ST36RB: S T I A P2, A P2; ST37RB: S T I A P2, A P2, L		
<b>MATERIALS</b>	Acrylic lens and plastic housing		
<b>VOLT/AMP</b>	12.8VDC - 2.3A Stop/Turn, 0.9A Tail		
<b>WT/DIMS</b>	.992 lb. / 7.875" x 3.25" x 2.875"		
<b>WARRANTY</b>	Three Year Warranty		

COMBINATION TAIL LIGHTS & KITS

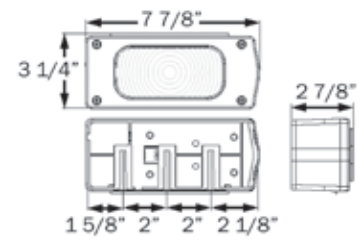



## ST56/57 SERIES

### Submersible Universal Mount Combination Tail Lights for Over 80" Applications

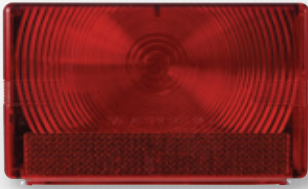

ST57RS

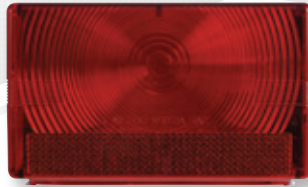



ST56RS

- Waterproof design for marine applications
- Shock mount guarantees long bulb life
- Mount on 2" centers
- Includes separate ground wire with eyelet
- Acrylic lens, corrosion proof plastic housing
- Passenger side light is 7-function: stop, turn, tail, rear clearance, rear reflex, side marker, and side reflex
- Driver side light also includes license illuminator
- Stainless steel mounting hardware

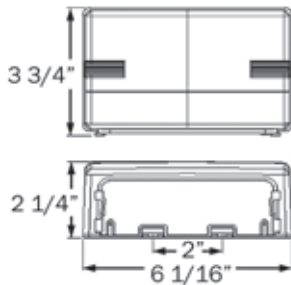
COMBINATION  
TAIL LIGHTS & KITS



BULK P/N	POLYPACK P/N	DESCRIPTION	QTY
<b>RETAIL</b>			
ST56RS		Passenger side light, clam	6
ST57RS		Driver side with license illuminator, clam	6
<b>ACCESSORIES</b>			
A1157B	A1157BP	1157 replacement bulb	50
A194B	A194BP	194 replacement bulb	100

<b>FMVSS</b>	ST56RB: S2 T2 I6 PC A; ST57RB: S2 T2 I6 PC A, L
<b>MATERIALS</b>	Acrylic lens and plastic housing
<b>VOLT/AMP</b>	12.8VDC - 2.3A Stop/Turn, 0.9A Tail
<b>WT/DIMS</b>	.639 lb. / 6.063" x 3.75" x 2.25"
<b>WARRANTY</b>	Three Year Warranty

## ST60 SERIES

### Universal Mount Combination Tail Lights

- Stud mount stop/turn/tail light with back-up and license illuminator built in
- Screw-on lens, easy to change bulbs
- Grounds through mounting studs
- Shock-proof socket guarantees long bulb life
- Acrylic lens, corrosion proof plastic housing

BULK P/N	POLYPACK P/N	DESCRIPTION	QTY
<b>STOP/TURN/TAIL LIGHTS</b>			
ST60RB	ST60RBP	Combination tail light	20
<b>ACCESSORIES</b>			
A60RB	A60RBP	Tail light lens	25
A2057B	A2057BP	2057 replacement bulb	50
A1156B	A1156BP	1156 replacement bulb	50
<b>RETAIL</b>			
ST60RS		Combination tail light, clam	6
<b>FMVSS</b>	S T A I R		
<b>MATERIALS</b>	Acrylic lens and plastic housing		
<b>VOLT/AMP</b>	12.8VDC - 2.3A Stop/Turn, 0.9A Tail		
<b>WT/DIMS</b>	.992 lb. / 5.75" x 6.625" x 2.813"		
<b>WARRANTY</b>	Three Year Warranty		

**optronics**



ST60RB

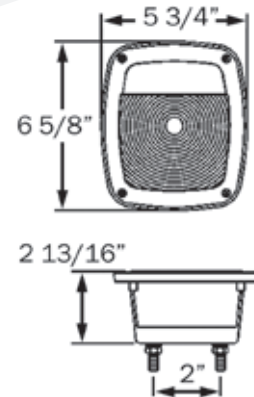

COMBINATION  
TAIL LIGHTS & KITS

## ST31 SERIES

### Weatherproof Surface Mount Light

- Snap-on lens, easy to change bulb
- Surface mount on 3-1/2" centers
- Hard wired, includes lead and ground wire
- Polycarbonate lens, steel base plate

BULK P/N	POLYPACK P/N	DESCRIPTION	QTY
<b>RED STOP/TURN/TAIL LIGHTS</b>			
ST31RB	ST31RBP	Light	50
<b>ACCESSORIES</b>			
A2057B	A2057BP	2057 replacement bulb	50
<b>RETAIL</b>			
ST31RS		Light, clam	12
<b>FMVSS</b>	S T I		
<b>MATERIALS</b>	Polycarbonate lens and steel housing		
<b>VOLT/AMP</b>	12.8VDC - 2.3A Stop/Turn, 0.90A Tail		
<b>WT/DIMS</b>	.309 lb. / 4.563" x 2.5" x 1.75"		
<b>WARRANTY</b>	Three Year Warranty		

**optronics**



ST31RB

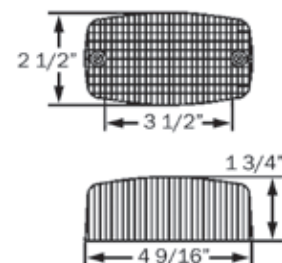



## TL22RK Magnetic Mount Towing Light Kit



TL22RK

- Magnetic mount towing light kit
- Pair of DOT compliant stop/turn/tail lights
- 20-ft wishbone style wiring harness and 4-ft trunk connector with 4-way flat plug
- Replaceable lens and bulb

BULK P/N	POLYPACK P/N	DESCRIPTION	QTY
<b>RETAIL</b>			
TL22RK		Towing light kit	2
<b>ACCESSORIES</b>			
A52RB	A52RBP	Tail light lens	25
A2057B	A2057BP	2057 replacement bulb	50



<b>FMVSS</b>	S T I
<b>MATERIALS</b>	Acrylic lens and plastic housing
<b>VOLT/AMP</b>	12.8VDC - 2.3A Stop/Turn, 0.9A Tail
<b>WT/DIMS</b>	3.53 lbs. / 7" x 4" x 2.125"
<b>WARRANTY</b>	Three Year Warranty

COMBINATION  
TAIL LIGHTS & KITS

## BU11CS Back-Up Light

- Single wire, grounds through mounting hardware
- Replaceable bulb (1156)

BULK P/N	POLYPACK P/N	DESCRIPTION	QTY
<b>RETAIL</b>			
BU11CS		Back-up light, chrome housing	12

FMVSS	R
MATERIALS	Polycarbonate lens and plastic housing
VOLT/AMP	12.8VDC - 0.4A
WT/DIMS	.221 lbs. / 3.25" x 3.25" x 1.938"
WARRANTY	Three Year Warranty



BU11CS



## BU41 SERIES Flange Mount Back-Up Light

- Hard wired, includes both lead and ground wire
- Replaceable bulb (1056)

BULK P/N	POLYPACK P/N	DESCRIPTION	QTY
<b>BACK-UP LIGHT</b>			
BU41CB	BU41CBP	Back-up light	50

FMVSS	R
MATERIALS	Acrylic lens, steel housing
VOLT/AMP	12.8VDC - 1.182A
WT/DIMS	.441 lbs. / 5.375" x 5.375" x 1.563"
WARRANTY	Three Year Warranty



BU41CB

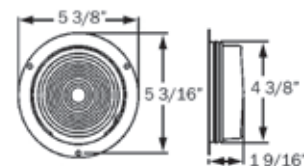

DOT COMPLIANT  
BACK-UP LIGHTS



## BU33/45/70 SERIES Sealed Back-Up Lights

- 4" round, 6" oval and rectangular models
- Sonically sealed, waterproof
- Flush mount design accepts standard two-way plug
- Shock proof socket guarantees long bulb life
- Kits include grommet and plug



BU45CB

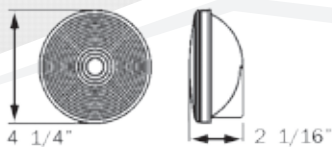

HOLE CUT-OUT: 4.5"



BU70CB

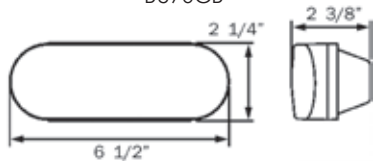

HOLE CUT-OUT: 6.85" x 2.5" (1.25" R)

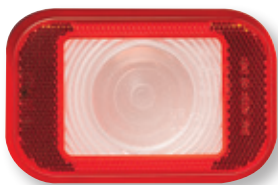

BU33CRXLB

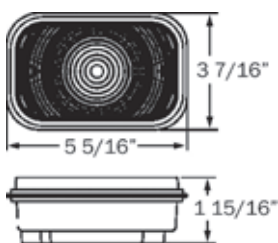

HOLE CUT-OUT: 5.453" x 3.578" (1" R)

DOT COMPLIANT  
BACK-UP LIGHTS

BULK P/N	POLYPACK P/N	DESCRIPTION	QTY
<b>4" ROUND BACK-UP LIGHTS</b>			
BU45CB	BU45CBP	Back-up light	50
BU44CB	BU44CBP	Kit: BU45CB, A45GB & A45CB	50
BU49CB	BU49CBP	Kit: BU45CB & A45GB	10
<b>6" OVAL BACK-UP LIGHTS</b>			
BU70CB	BU70CBP	Back-up light	50
BU74CB	BU74CBP	Kit: BU70CB, A70GB & A45CB	50
BU64CB	BU64CBP	Kit: BU70CB, A70GB & A49PB (pigtail attached to light)	50
BU65CB	BU65CBP	Kit: BU70CB, A70GB & A49PB	50
<b>RECTANGULAR BACK-UP LIGHTS</b>			
BU33CRXLB	BU33CRXLBP	Back-up light with red reflex	20
BU33CRX24LB	BU33CRX24LBP	Back-up light with red reflex, 24V	20
<b>ACCESSORIES</b>			
A45GB	A45GBP	4" round grommet	50
A70GB	A70GBP	6" oval grommet	50
A33GB	A33GBP	Rectangular grommet	50
A45CB	A45CBP	Straight two-wire pigtail	100
A49PB	A49PBP	Right angle two-wire pigtail	100

<b>FMVSS</b>	R BU33CRX: (2)R A
<b>MATERIALS</b>	Polycarbonate lens and housing
<b>VOLT/AMP</b>	BU45: 12.8VDC - 2.182A BU70: 12.8VDC - 0.4A BU33: 12.8VDC - 1.6A; 24.0VDC - .87A
<b>WT/DIMS</b>	BU45: .176 lbs. / 4.25" x 4.25" x 2.063" BU70: .265 lbs. / 6.5" x 2.25" x 2.375" BU33: .441 lbs. / 5.313" x 3.438" x 1.938"
<b>WARRANTY</b>	Three Year Warranty

## M1 SERIES

### Millennium Series® 6.5” Marker/Clearance Lights

- Replaceable lens and bulb
- Hard wired, includes separate ground wire
- Available with .180 male bullets or metripack connector
- Choose from light only or kit with chrome bezel



M1 WITH BEZEL



M1 WITH BEZEL

BULK P/N	POLYPACK P/N	DESCRIPTION	QTY
<b>YELLOW</b>			
00212351B	00212351P	12V, .180 bullets	20
00212331B	00212331P	12V Kit: .180 bullets, bezel	20
00212031B	00212031P	24V Kit: .180 bullets, bezel	20
00212362B	00212362P	12V, Metripack connector	20
00212342B	00212342P	12V Kit: Metripack connector, bezel	20
<b>RED</b>			
00212333B	00212333P	12V Kit: .180 bullets, bezel	20
<b>ACCESSORIES</b>			
00212317B	00212327P	Bezel	100/20
00212011B	00212005P	Socket with 193 bulb, .180 bullets	100/20

<b>FMVSS</b>	P2
<b>MATERIALS</b>	Polycarbonate lens, housing and bezel
<b>VOLT/AMP</b>	12.8VDC - 0.33A; 24.0VDC - 0.17A
<b>WARRANTY</b>	Three Year Warranty

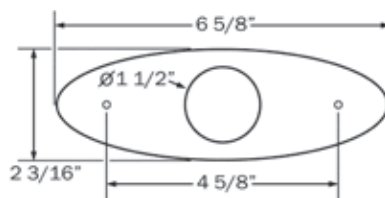

HOLE CUT-OUT: 1.5"



MILLENNIUM SERIES  
MARKER/CLEARANCE LIGHTS



## M3 SERIES Millennium Series® 3" Marker/Clearance Lights

- Replaceable lens and bulb
- Hard wired, includes separate ground wire
- Molded .180 male bullets
- Choose from light only or kit with chrome bezel



M3 WITH BEZEL



M3 WITH BEZEL



M3 CLEAR LENS WITH BEZEL



BULK P/N	POLYPACK P/N	DESCRIPTION	QTY
<b>YELLOW</b>			
00212251B	00212251P	.180 bullets	20
00212231B	00212231P	Kit: .180 bullets, bezel	20
<b>RED</b>			
00212253B	00212253P	.180 bullets	20
00212233B	00212233P	Kit: .180 bullets, bezel	20
<b>CLEAR</b>			
00212239B	00212239P	Kit: .180 bullets, bezel	20
<b>ACCESSORIES</b>			
00212217B	00212227P	Bezel	500/20
00212011B	00212005P	Socket with 193 bulb, .180 bullets	100/20

FMVSS	P2
MATERIALS	Polycarbonate lens, housing and bezel
VOLT/AMP	12.8VDC - 0.33A
WARRANTY	Three Year Warranty

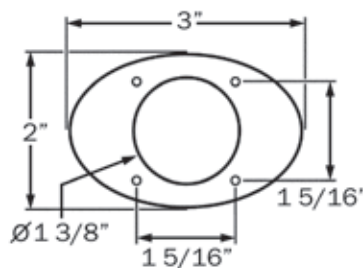

HOLE CUT-OUT: 1.375"

MILLENNIUM SERIES  
MARKER/CLEARANCE LIGHTS



## MC25/27 SERIES 2" & 2.5" Sealed Beehive Style Marker/Clearance Lights



- Sonically sealed, waterproof
- Clearance, side marker, or rear tracking light applications
- Accepts standard two-pin PL-10 plug

BULK P/N	POLYPACK P/N	DESCRIPTION	QTY
<b>YELLOW</b>			
MC25AB	MC25ABP	2" light	20
MC27AB	MC27ABP	2.5" light	20
<b>RED</b>			
MC25RB	MC25RBP	2" light	20
MC27RB	MC27RBP	2.5" light	20
<b>ACCESSORIES</b>			
A46PB	A46BPB	Straight PL-10 plug, 6" lead	100
A86PB	A86PBP	Straight PL-10 plug, 18" lead	100
A54GB	A54GBP	2" Flush mount grommet	100
A54GK	A54GKP	2" Kit: A54GB and A46PB	100
A55CB	A55CBP	2" Chrome trim ring	20
A55GB	A55GBP	2.5" Flush mount grommet (open back)	50
A56GB	A56GBP	2.5" Recess mount grommet (closed back)	100
A57GB	A57GBP	2.5" Recess mount grommet (open back)	50
A55GK	A55GKP	2.5" Kit: A55GB and A46PB	100
A57GK	A57GKP	2.5" Kit: A57GB and A46PB	100
A57CB	A57CBP	2.5" Chrome trim ring	20
BK5557GB	BK5557GBP	2"/2.5" Cam-on mounting bracket	50



MC25AB



MC25RB



MC27AB



MC27RB

SEALED MARKER/  
CLEARANCE LIGHTS

<b>FMVSS</b>	P2
<b>MATERIALS</b>	Polycarbonate lens and housing
<b>VOLT/AMP</b>	12.8VDC - 0.2A
<b>WT/DIMS</b>	MC25: .088 lbs. / 2" x 2" x 1.75" MC27: .110 lbs. / 2.5" x 2.5" x 2.313"
<b>WARRANTY</b>	Three Year Warranty



MC25 SERIES  
HOLE CUT-OUT: 2.313"

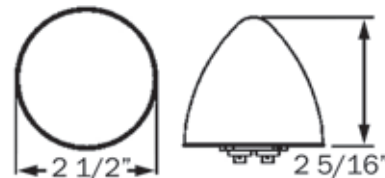

MC27 SERIES  
HOLE CUT-OUT: 2.75"



## MC52 SERIES

### 2" Round Sealed Recess Flange Mount Marker/Clearance Lights

- Sonically sealed, waterproof light for recess mount
- Accepts standard two-pin PL-10 plug
- Available in yellow and red models, with black or reflex flange
- Reflex flange model meets SAE "A" requirements for conspicuity

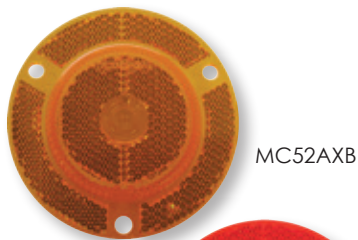

SEALED MARKER/  
CLEARANCE LIGHTS

BULK P/N	POLYPACK P/N	DESCRIPTION	QTY
<b>YELLOW</b>			
MC52AB	MC52ABP	Yellow, black flange	50
MC52AXB	MC52AXBP	Yellow, reflex lens and flange	50
<b>RED</b>			
MC52RB	MC52RBP	Red, black flange	50
MC52RXB	MC52RXBP	Red, reflex lens and flange	50
<b>ACCESSORIES</b>			
A46PB	A46BPB	Straight PL-10 plug, 6" lead	100
A86PB	A86BPB	Straight PL-10 plug, 18" lead	100
A3TRSSB	-	Stainless steel flange cover	100

<b>FMVSS</b>	Black flange: P2 Reflex flange: A P2
<b>MATERIALS</b>	Polycarbonate lens and housing
<b>VOLT/AMP</b>	12.8VDC - 0.2A
<b>WT/DIMS</b>	Black flange: .066 lbs. / 2.938" x 2.938" x .813" Reflex flange: .066 lbs. / 2.984" x 2.984" x .75"
<b>WARRANTY</b>	Three Year Warranty

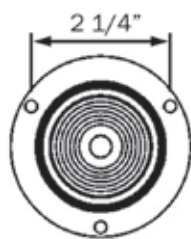

MC52 Black Flange

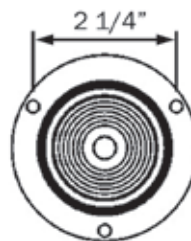

MC52 Reflex Flange

## MC53 & MC54 SERIES 2" Sealed Marker/Clearance Lights



- Sonically sealed, waterproof
- Accept standard two-pin PL-10 plugs
- Available in yellow, red, and yellow ABS models
- Available in recess and surface mount models

BULK P/N	POLYPACK P/N	DESCRIPTION	QTY
<b>YELLOW</b>			
MC53AB	MC53ABP	Recess mount	50
MC53ABSB	MC53ABSBP	Recess mount "ABS"	50
MC53AKB	MC53AKBP	Kit: MC53AB, A54GB and A46PB	50
MC54AB	MC54ABP	Flange surface mount	50
MC505ABSB	MC505ABSBP	Flange surface mount "ABS"	50
<b>RED</b>			
MC53RB	MC53RBP	Recess mount	50
MC53RKB	MC53RKBP	Kit: MC53RB, A54GB and A46PB	50
MC54RB	MC54RBP	Flange surface mount	50
<b>ACCESSORIES</b>			
A46PB	A46PBP	Straight PL-10 plug, 6" lead	100
A86PB	A86PBP	Straight PL-10 plug, 18" lead	100
A54GB	A54GBP	2" Flush mount grommet	100
A54GK	A54GKP	2" Kit: A54GB and A46PB	100
A55CB	A55CBP	2" Chrome trim ring	20
BK5557GB	BK5557GBP	Cam-on mounting bracket	50
<b>RETAIL</b>			
MC53AS		Yellow recess mount light, clam	12
MC53RS		Red recess mount light, clam	12

<b>FMVSS</b>	P2 PC
<b>MATERIALS</b>	Polycarbonate lens and housing
<b>VOLT/AMP</b>	12.8VDC - 0.2A
<b>WT/DIMS</b>	MC53: .066 lbs. / 2" x 2" x .688" MC54/505: .066 lbs. / 2.938" x 2.938" x .813"
<b>WARRANTY</b>	Three Year Warranty

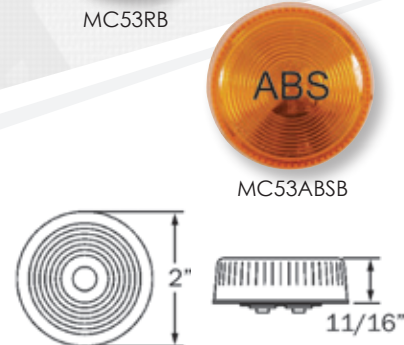

HOLE CUT-OUT: 2.313"



SURFACE MOUNT

SEALED MARKER/  
CLEARANCE LIGHTS



## MC55 & MC57 SERIES 2.5" Sealed Marker/Clearance Lights for Recess Mount



MC55AB



MC55RB



MC57AB  
MC57AS

SAE A REFLEX  
P2 RATED



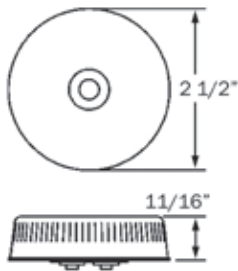

MC57RB  
MC57RS



HOLE CUT-OUT: 2.75"

- Sonically sealed, waterproof design for recess mount
- Accept standard two-pin PL-10 plug
- MC55 series lights are PC rated
- MC57 series lights feature built-in reflex

BULK P/N	POLYPACK P/N	DESCRIPTION	QTY
<b>YELLOW</b>			
MC55AB	MC55ABP	PC rated light	50
MC57AB	MC57ABP	P2 rated light with reflex	50
<b>RED</b>			
MC55RB	MC55RBP	PC rated light	50
MC57RB	MC57RBP	P2 rated light with reflex	50
<b>ACCESSORIES</b>			
A46PB	A46PBP	Straight PL-10 plug, 6" lead	100
A86PB	A86PBP	Straight PL-10 plug, 18" lead	100
A55GB	A55GBP	Flush mount grommet, open back	50
A56GB	A56GBP	Recess mount grommet, closed back	100
A57GB	A57GBP	Recess mount grommet, open back	50
A55GK	A55GKP	Kit: A55GB & A46PB	100
A57GK	A57GKP	Kit: A57GB & A46PB	100
A57CB	A57CBP	Chrome trim ring	20
BK5557GB	BK5557GBP	Cam-on mounting bracket	50
<b>RETAIL</b>			
MC57AS		Yellow light with reflex, clam	12
MC57RS		Red light with reflex, clam	12

<b>FMVSS</b>	MC55: P2 PC MC57: A P2
<b>MATERIALS</b>	Polycarbonate lens and housing
<b>VOLT/AMP</b>	12.8VDC - 0.2A
<b>WT/DIMS</b>	.066 lbs. / 2.5" x 2.5" x .688"
<b>WARRANTY</b>	Three Year Warranty

SEALED MARKER/  
CLEARANCE LIGHTS

## MC56 & MC59 SERIES 2.5" Sealed Recess Flange Mount Marker/Clearance Lights

- Sonically sealed, waterproof light for recess mount
- Accepts standard two-pin PL-10 plug
- MC59 series lights include reflex meeting SAE "A" conspicuity requirement

BULK P/N	POLYPACK P/N	DESCRIPTION	QTY
<b>YELLOW</b>			
MC56AB	MC56ABP	Recess flange mount	50
MC59AFB	MC59AFBP	Recess flange mount, reflex lens	50
<b>RED</b>			
MC56RB	MC56RBP	Recess flange mount	50
MC59RFB	MC59RFBP	Recess flange mount, reflex lens	50
<b>ACCESSORIES</b>			
A46PB	A46PBP	Straight PL-10 plug, 6" lead	100
A86PB	A86PBP	Straight PL-10 plug, 18" lead	100

<b>FMVSS</b>	MC56: P2 MC59: A P2
<b>MATERIALS</b>	Polycarbonate lens and housing
<b>VOLT/AMP</b>	12.8VDC - 0.2A
<b>WT/DIMS</b>	.11 lb. / 3.438" x 3.438" x .938"
<b>WARRANTY</b>	Three Year Warranty

**optronics**



SEALED MARKER/  
CLEARANCE LIGHTS

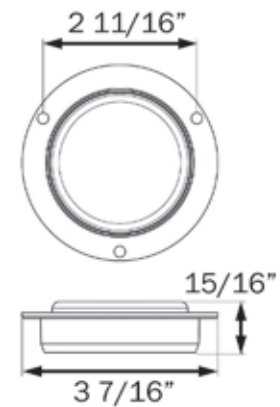

HOLE CUT-OUT: 2.75"



## MC61ABKB

### Sealed Marker/Clearance Light and Reflector in Elevated Bracket



MC61ABKB

- Sonically sealed, waterproof
- PC rated light fulfills front side marker requirement when properly mounted on a 15 degree angle
- Corrosion proof, surface mount wedge base
- Single wire design grounds through mounting hardware

SEALED MARKER/  
CLEARANCE LIGHTS

BULK P/N	POLYPACK P/N	DESCRIPTION	QTY
<b>LIGHT/REFLECTOR ASSEMBLY</b>			
MC61ABKB	MC61ABKBP	Light & reflector in bracket	20
<b>ACCESSORIES</b>			
BK61AB	-	Bracket with reflector	20

FMVSS	Light: P2 PC; Reflector: A
MATERIALS	Polycarbonate lens and housing; Acrylic reflector
VOLT/AMP	12.8VDC - 0.2A
WT/DIMS	.066 lbs. / 6.687" x 1.5" x 1.625"
WARRANTY	Three Year Warranty

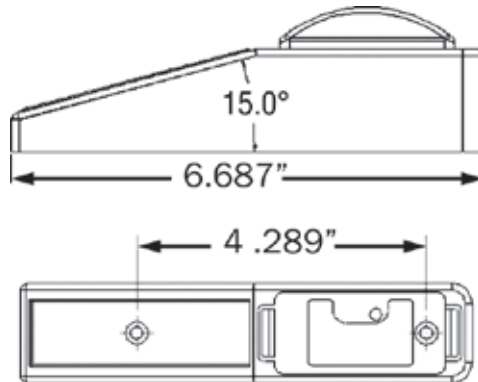

## MC65/67 & BA65 SERIES Sealed Fender Lights

- Sonically sealed, waterproof
- PC rated design includes two bulbs
- Multiple mounting and wiring options available
- Single wire design grounds through mounting hardware
- Two-wire design includes both lead and ground wires

BULK P/N	POLYPACK P/N	DESCRIPTION	QTY
<b>AMBER/RED FENDER LIGHT</b>			
MC65ARB	MC65ARBP	Light only	50
MC67ARB	MC67ARBP	Kit: MC65ARB & A65PB bracket/plug	50
<b>AMBER/RED FENDER LIGHT ASSEMBLIES</b>			
BA65ARLB	BA65ARLBP	Fender light assembly, left side: MC65AB & MC65RB in fender mount bracket	25
BA65ARRB	BA65ARRBP	Fender light assembly, right side: MC65AB & MC65RB in fender mount bracket	25
<b>ACCESSORIES</b>			
A67BB	A67BBP	Fender bracket, black	50
A67GB	A67GBP	Fender bracket, gray	50
A67CVB	A67CVBP	Curved fender bracket, gray	50
A65B	A65BP	Black bracket	50
A65P	A65PP	Single wire plug, .156 male bullet	50
A65PB	A65PBP	Kit: A65B black bracket & A65P plug	50
A66PB	A66PBP	Kit: Gray bracket & A65P plug	50
A67CB	A67CBP	Kit: Chrome bracket & A65P plug	50
A68PB	A68PBP	Kit: Black bracket & 2-wire plug	50

For more details on mounting and wiring accessories,  
see Accessories section at back of catalog.

<b>FMVSS</b>	MC65ARB: P2 BA65: P2 P3 PC2
<b>MATERIALS</b>	MC65: Polycarbonate lens and housing BA65: Polycarbonate lens and housing, plastic bracket
<b>VOLT/AMP</b>	MC65: 12.8VDC - 0.689A BA65: 12.8VDC - 0.8A
<b>WT/DIMS</b>	MC65: .066 lbs. / 3.938" x 1.25" x .875" BA65: .375 lbs. / 9.188" x 4.688" x 1.875"
<b>WARRANTY</b>	Three Year Warranty

**optronics**



MC65ARB



MC67ARB

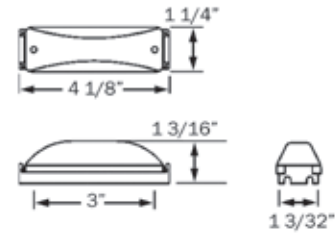

SEALED MARKER/  
CLEARANCE LIGHTS



BA65ARLB

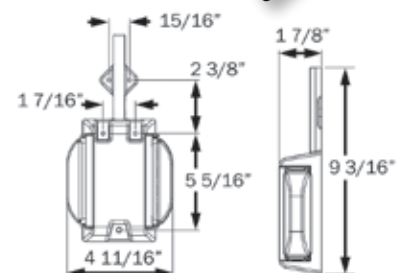



## MC65/67 SERIES

### Sealed Marker/Clearance Lights



- Sonically sealed, waterproof
- PC rated design includes two bulbs
- Multiple mounting and wiring options available
- Single wire design grounds through mounting hardware
- Two-wire design includes both lead and ground wires

MC65AB



MC65RB

MC67AB  
MC67AK



MC67RB  
MC67RK

SEALED MARKER/  
CLEARANCE LIGHTS

BULK P/N	POLYPACK P/N	DESCRIPTION	QTY
<b>YELLOW</b>			
MC65AB	MC65ABP	Light only	50
MC67AB	MC67ABP	Kit: MC65AB & A65PB	50
<b>RED</b>			
MC65RB	MC65RBP	Light only	50
MC67RB	MC67RBP	Kit: MC65RB & A65PB	50
<b>ACCESSORIES</b>			
A65B	A65BP	Black bracket	50
A65P	A65PP	Single wire plug, .156 male bullet	50
A65PB	A65PBP	Kit: A65B black bracket & A65P plug	50
A66PB	A66PBP	Kit: Gray bracket & A65P plug	50
A67CB	A67CBP	Kit: Chrome bracket & A65P plug	50
A68PB	A68PBP	Kit: Black bracket & 2-wire plug	50
For more details on mounting and wiring accessories, see Accessories section at back of catalog.			
<b>RETAIL</b>			
MC67AK		Yellow kit: MC65AB & A65PB, clam	12
MC67RK		Red kit: MC65RB & A65PB, clam	12

<b>FMVSS</b>	P2 P3 PC2
<b>MATERIALS</b>	Polycarbonate lens and housing
<b>VOLT/AMP</b>	12.8VDC - 0.4A
<b>WT/DIMS</b>	.066 lbs. / 3.938" x 1.25" x .875"
<b>WARRANTY</b>	Three Year Warranty



MC65

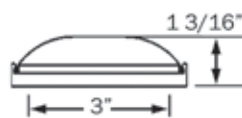
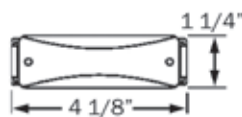

MC67





## MC91 SERIES Sealed Marker/Clearance Lights

- Sonically sealed, waterproof
- PC rated design
- Multiple mounting and wiring options available
- Single wire design grounds through mounting hardware
- Two-wire design includes both lead and ground wires



BULK P/N	POLYPACK P/N	DESCRIPTION	QTY
<b>YELLOW</b>			
A91AB	A91ABP	Light only	100
MC91AB	MC91ABP	Kit: A91AB, A91CB & A91LW	50
MC92AB	MC92ABP	Kit: A91AB, A91BB & A91LW	50
<b>RED</b>			
A91RB	A91RBP	Light only	100
MC92RB	MC92RBP	Kit: A91RB, A91BB & A91LW	50
<b>ACCESSORIES</b>			
A46PB	A46PBP	2-wire plug, 6" lead	100
A86PB	A86PBP	2-wire plug, 18" lead	100
A91LW	A91LWP	1-wire plug, 12" lead	100
A91BB	A91BBP	Black base, self grounding	100
A91BOB	A91BOBP	Black base, open back	100
A91CB	A91CBP	Chrome base, self grounding	100
A91OB	A91OBP	Chrome base, open back	100
A91GB	A91GBP	Grommet	100
<b>RETAIL</b>			
MC90AS		Yellow light only, clam	12
MC90RS		Red light only, clam	12
MC91AS		Yellow light kit: A91AB, A91CB chrome base, A91LW single wire plug, clam	12
MC91RS		Red light kit: A91RB, A91CB chrome base, A91LW single wire plug, clam	12
MC92AS		Yellow light kit: A91AB, A91BB black base, A91LW single wire plug, clam	12
MC92RS		Red light kit: A91RB, A91BB black base, A91LW single wire plug, clam	12

<b>FMVSS</b>	P2 PC
<b>MATERIALS</b>	Polycarbonate lens and housing
<b>VOLT/AMP</b>	12.8VDC - 0.2A
<b>WT/DIMS</b>	.066 lbs. / 2.5" x 1.188" x .875"
<b>WARRANTY</b>	Three Year Warranty



A91AB  
MC90AS



A91RB  
MC90RS



MC91AB  
MC91AS



MC91RS



MC92AB  
MC92AS



MC92RB  
MC92RS

SEALED MARKER/  
CLEARANCE LIGHTS

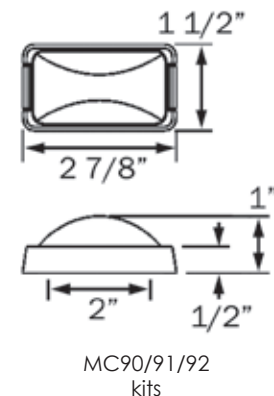
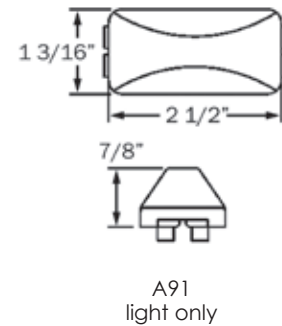



## MC11 SERIES Mini Marker/Clearance Lights

- Surface mount on 2-3/4" centers
- Single wire design grounds through mounting hardware
- Snap-on lens, replaceable bulb



MC11AB





MC11RB

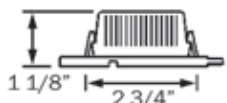
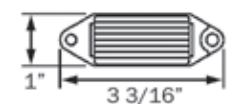

UL11BS



MC11AK

BULK P/N	POLYPACK P/N	DESCRIPTION	QTY
<b>YELLOW</b>			
MC11AB	MC11ABP	Yellow, black base	50
<b>RED</b>			
MC11RB	MC11RBP	Red, black base	50
<b>ACCESSORIES</b>			
A11AB	A11ABP	Yellow replacement lens	50
A11RB	A11RBP	Red replacement lens	50
A194B	A194BP	194 replacement bulb	100
<b>RETAIL</b>			
MC11AS		Yellow light, clam	12
MC11RS		Red light, clam	12
MC11AK		(6) MC11AB, hardware, connectors, clam	6
UL11BS		Blue utility light, clam	12

<b>FMVSS</b>	P2 (except UL11BS)
<b>MATERIALS</b>	Acrylic lens, ABS housing
<b>VOLT/AMP</b>	12.8VDC - 0.4A
<b>WT/DIMS</b>	.044 lbs. / 3.188" x 1" x 1.125"
<b>WARRANTY</b>	Three Year Warranty

SURFACE MOUNT  
MARKER/CLEARANCE LIGHTS



## MC30 SERIES Marker/Clearance Light with Reflex

- Surface mount on 2" centers
- Plug-n-go design for quick connection to power and ground
- Snap-on lens, replaceable bulb



MC30AB

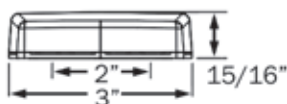
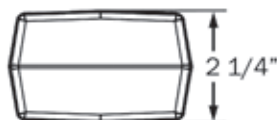

BULK P/N	POLYPACK P/N	DESCRIPTION	QTY
<b>YELLOW</b>			
MC30AB	MC30ABP	Yellow	20
<b>ACCESSORIES</b>			
A194B	A194BP	194 replacement bulb	100

<b>FMVSS</b>	A P2 PC
<b>MATERIALS</b>	Acrylic lens, ABS housing
<b>VOLT/AMP</b>	12.8VDC - 0.2A
<b>WT/DIMS</b>	.11 lb. / 3" x 2.25" x .938"
<b>WARRANTY</b>	Three Year Warranty

## MC21/22 SERIES

### Beehive Marker/Clearance Lights



- Surface mount on 3/4" centers
- Single wire design grounds through mounting hardware
- Snap-on lens, replaceable bulb



MC22AB



MC22RB

BULK P/N	POLYPACK P/N	DESCRIPTION	QTY
<b>YELLOW</b>			
MC22AB	MC22ABP	Yellow	50
<b>RED</b>			
MC22RB	MC22RBP	Red	50
<b>RETAIL</b>			
MC21AS		Yellow light, clam	12
MC21RS		Red light, clam	12

<b>FMVSS</b>	P2 PC
<b>MATERIALS</b>	Acrylic lens, steel bracket
<b>VOLT/AMP</b>	12.8VDC - 0.4A
<b>WT/DIMS</b>	MC22: .176 lbs. / 2.563" x 2.563" x 3.688" MC21: .176 lbs. / 2.563" x 2.563" x 4.063"
<b>WARRANTY</b>	Three Year Warranty



MC21AS



MC21RS

SURFACE MOUNT  
MARKER/CLEARANCE LIGHTS

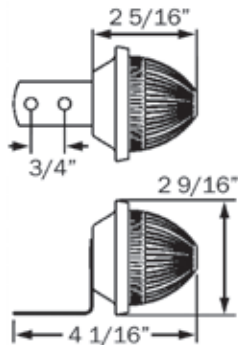

MC21

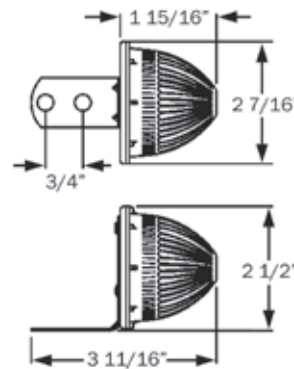

MC22



## MC31/32 SERIES

### Surface Mount Marker/Clearance Lights with Reflex

- Surface mount on 3" centers
- Lens with reflex eliminates need for separate reflector
- MC31 is single wire design, grounds through mounting hardware
- MC32 has twist-in socket with separate ground wire
- Snap-on lens, replaceable 194 bulb



MC31AB



MC31RB

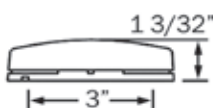
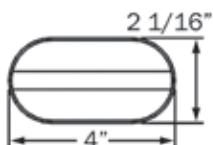

MC32AB



MC32RB

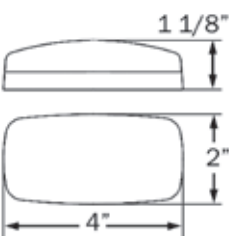

A32GB

SURFACE MOUNT MARKER/CLEARANCE LIGHTS

BULK P/N	POLYPACK P/N	DESCRIPTION	QTY
<b>YELLOW</b>			
MC31AB	MC31ABP	Oval, black base, single wire	50
MC31A15B2	-	MC31AB with .156 female barrels	50
MC32AB	MC32ABP	Oblong, white base, two-wire	100
MC32ABB	MC32ABBP	Oblong, black base, two-wire	100
<b>RED</b>			
MC31RB	MC31RBP	Oval, black base, single wire	50
MC31R15B2	-	MC31RB with .156 female barrels	50
MC32RB	MC32RBP	Oblong, white base, two-wire	100
MC32RBB	MC32RBBP	Oblong, black base, two-wire	100
<b>ACCESSORIES</b>			
A31AB	A31ABP	Yellow replacement lens, MC31	50
A31RB	A31RBP	Red replacement lens, MC31	50
A32AB	A32ABP	Yellow replacement lens, MC32	50/10
A32RB	A32RBP	Red replacement lens, MC32	50/10
A32GB	A32GBP	Mounting gasket, white	500
A194B	A194BP	194 replacement bulb	100
<b>RETAIL</b>			
MC31AS		MC31AB, clam	12
MC31RS		MC31RB, clam	12
MC32AS		MC32AB, clam	12
MC32ABS		MC32ABB, clam	12
MC32RS		MC32RB, clam	12
MC32RBS		MC32RBB, clam	12

<b>FMVSS</b>	A P2
<b>MATERIALS</b>	Acrylic lens, ABS housing
<b>VOLT/AMP</b>	12.8VDC - 0.2A
<b>WT/DIMS</b>	MC31: .088 lb. / 4" x 2.063" x 1.094" MC32: .11 lb. / 4" x 2" x 1.125"
<b>WARRANTY</b>	Three Year Warranty

## MC35/36 SERIES

### Surface Mount Marker/Clearance Lights with Reflex

- Surface mount lights; choose from ear mount or stud mount versions
- Lens with reflex eliminates need for separate reflector
- MC35 is ear mount version
- MC36 is stud mount version
- Single wire design grounds through mounting hardware
- Screw-on lens, replaceable bulb, black plastic base



MC35AB



MC35RS

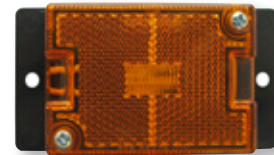

MC35AEB



MC36AB



MC36RB

SURFACE MOUNT MARKER/CLEARANCE LIGHTS

BULK P/N	POLYPACK P/N	DESCRIPTION	QTY
<b>YELLOW</b>			
MC35AB	MC35ABP	Yellow ear mount	50
MC35AEB	MC35AEBP	Yellow ear mount, rectangular	200
MC36AB	MC36ABP	Yellow stud mount	50
<b>RED</b>			
MC36RB	MC36RBP	Red stud mount	50
<b>ACCESSORIES</b>			
A36AB	A36ABP	Yellow replacement lens	50
A36RB	A36RBP	Red replacement lens	50
A194B	A194BP	194 replacement bulb	100
<b>RETAIL</b>			
MC35AS		Yellow ear mount light, clam	12
MC36AS		Yellow stud mount light, clam	12
MC36RS		Red stud mount light, clam	12

<b>FMVSS</b>	AP2
<b>MATERIALS</b>	Acrylic lens, ABS housing
<b>VOLT/AMP</b>	12.8VDC - 0.2A
<b>WT/DIMS</b>	MC35: .132 lb. / 3.875" x 2.375" x 1.094" MC35AEB: .132 lb. / 3.75" x 2.063" x .938" MC36: .132 lb. / 2.75" x 2.125" x 1"
<b>WARRANTY</b>	Three Year Warranty

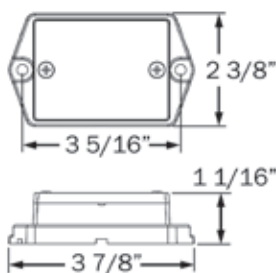

MC35

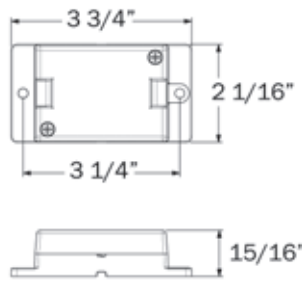

MC35AEB

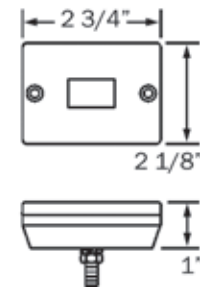

MC36



## MC37 SERIES Stud Mount Marker/Clearance Light with Reflex



MC37AB

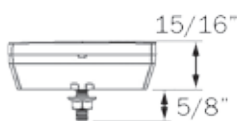
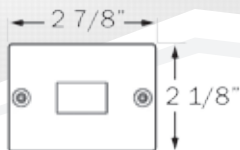

- Stud mount design; grounds through mounting stud
- Lens with reflex eliminates need for separate reflector
- Replaceable bulb
- Polycarbonate lens and housing

BULK P/N	POLYPACK P/N	DESCRIPTION	QTY
<b>YELLOW</b>			
MC37AB	MC37ABP	Yellow	50
<b>ACCESSORIES</b>			
A194B	A194BP	194 replacement bulb	100

<b>FMVSS</b>	A P2
<b>MATERIALS</b>	Polycarbonate lens and housing
<b>VOLT/AMP</b>	12.8VDC - 0.2A
<b>WT/DIMS</b>	.11 lb. / 2.875" x 2.125" x .938"
<b>WARRANTY</b>	Three Year Warranty

SURFACE MOUNT  
MARKER/CLEARANCE LIGHTS



## MC38 SERIES Surface Mount Marker/Clearance Lights with Reflex

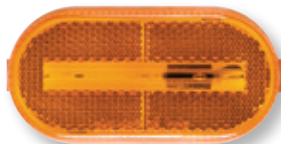

MC38AB

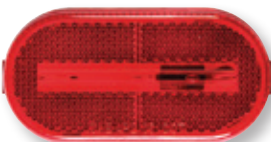

MC38RB

- Surface mount on 3" centers
- Lens with reflex eliminates need for separate reflector
- Single wire design grounds through mounting hardware
- Snap-on lens, replaceable bulb

BULK P/N	POLYPACK P/N	DESCRIPTION	QTY
<b>YELLOW</b>			
MC38AB	MC38ABP	Yellow	50
<b>RED</b>			
MC38RB	MC38RBP	Red	50
<b>ACCESSORIES</b>			
A38AB	A38ABP	Yellow replacement lens	50
A38RB	A38RBP	Red replacement lens	50
A194B	A194BP	194 replacement bulb	100

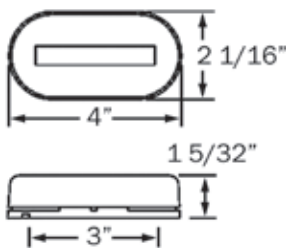

<b>FMVSS</b>	A P2
<b>MATERIALS</b>	Acrylic lens, ABS housing
<b>VOLT/AMP</b>	12.8VDC - 0.2A
<b>WT/DIMS</b>	.11 lb. / 4" x 2.063" x 1.156"
<b>WARRANTY</b>	Three Year Warranty

## MC42 SERIES

### Dual Bulb Marker/Clearance Lights

- Dual bulb, bullseye style lights with black base
- Snap-on lens and replaceable bulbs
- Surface mount on 3" centers
- Single wire design grounds through mounting hardware

BULK P/N	POLYPACK P/N	DESCRIPTION	QTY
<b>YELLOW</b>			
MC42AB	MC42ABP	Yellow	50
<b>RED</b>			
MC42RB	MC42RBP	Red	50
<b>ACCESSORIES</b>			
A42AB	A42ABP	Yellow replacement lens	10
A42RB	A42RBP	Red replacement lens	10
A194B	A194BP	194 replacement bulb	100
<b>RETAIL</b>			
MC42AS		Yellow light, clam	12
MC42RS		Red light, clam	12
<b>FMVSS</b>	P2		
<b>MATERIALS</b>	Acrylic lens, ABS housing		
<b>VOLT/AMP</b>	12.8VDC - 0.4A		
<b>WT/DIMS</b>	.088 lb. / 4.094" x 2.125" x 1.125"		
<b>WARRANTY</b>	Three Year Warranty		



MC42AB

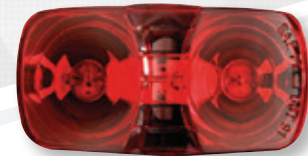

MC42RB

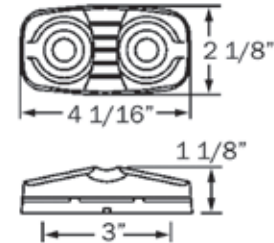

SURFACE MOUNT  
MARKER/CLEARANCE LIGHTS

## MC48 SERIES

### Marker/Clearance Lights with Reflex

- Flush mount on 3-3/8" centers
- Lens with reflex eliminates need for separate reflector
- Twist-in socket with replaceable bulb and ground wire

BULK P/N	POLYPACK P/N	DESCRIPTION	QTY
<b>YELLOW</b>			
MC48AB	MC48ABP	Yellow	50
MC48APG	MC48APGP	Yellow with .156 female barrels	50
<b>RED</b>			
MC48RPG	MC48RPGP	Red with .156 female barrels	50
<b>ACCESSORIES</b>			
A194B	A194BP	194 replacement bulb	100
<b>FMVSS</b>	A P2		
<b>MATERIALS</b>	Acrylic lens, ABS housing		
<b>VOLT/AMP</b>	12.8VDC - 0.2A		
<b>WT/DIMS</b>	.132 lb. / 3.906" x 1.843" x 1.031"		
<b>WARRANTY</b>	Three Year Warranty		



MC48AB/APG



MC48RPG

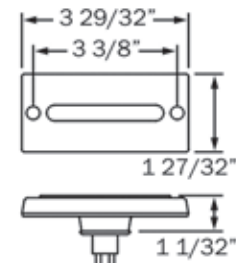



## MC44 & BA44 SERIES Surface Mount Marker/Clearance Lights with Reflex



MC44AB



MC44RB



A44GB

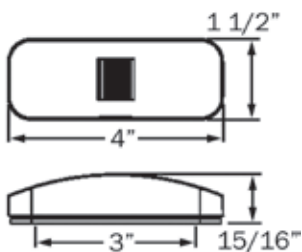

BA44FNL

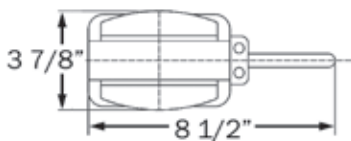

- Surface mount on 3" centers
- Lens with reflex eliminates need for separate reflector
- Two-wire design includes both lead and ground wire
- Snap-on lens, replaceable bulb
- Fender light assembly includes one each MC44AB and MC44RB in black ABS bracket; female plug on power wire, grounding eyelet on ground wire

BULK P/N	POLYPACK P/N	DESCRIPTION	QTY
<b>YELLOW</b>			
MC44AB	MC44ABP	Yellow, two-wire	50
MC44AB1	MC44AB1P	Yellow, single wire	50
<b>RED</b>			
MC44RB	MC44RBP	Red, two-wire	50
MC44RB1	MC44RB1P	Red, single wire	50
<b>YELLOW/RED FENDER</b>		<b>LIGHT ASSEMBLY</b>	
BA44FNL	BA44FNLP	Left side	25
BA44FNR	BA44FNRP	Right side	25
<b>ACCESSORIES</b>			
MC441WB	-	Single wire base only	500
MC442WB	-	Two-wire base only	50
A44A500B	-	Yellow replacement lens, 500-pack	500
A44R500B	-	Red replacement lens, 500-pack	500
A44AB	A44ABP	Yellow replacement lens	10
A44RB	A44RBP	Red replacement lens	10
A194B	A194BP	194 replacement bulb	100
A44GTB	-	Mounting gasket, thick, white	1000
<b>RETAIL</b>			
MC44AS		Yellow light, clam	12
MC44RS		Red light, clam	12



<b>FMVSS</b>	A P2
<b>MATERIALS</b>	Acrylic lens, ABS housing
<b>VOLT/AMP</b>	MC44: 12.8VDC - 0.4A BA44: 12.8VDC - 0.8A
<b>WT/DIMS</b>	MC44: .066 lb. / 4" x 1.5" x .938" BA44: .353 lb. / 8.5" x 3.875" x 1.75"
<b>WARRANTY</b>	Three Year Warranty

SURFACE MOUNT  
MARKER/CLEARANCE LIGHTS



## MC58 SERIES 2.5" Marker/Clearance Lights

- Surface mount on 1-1/2" centers
- Single wire design grounds through mounting hardware
- Snap-on lens, replaceable bulb

BULK P/N	POLYPACK P/N	DESCRIPTION	QTY
<b>RED</b>			
MC58RB	MC58RBP	Red	50
<b>ACCESSORIES</b>			
A194B	A194BP	194 replacement bulb	100
<b>RETAIL</b>			
MC58AS		Yellow light, clam	12
MC58RS		Red light, clam	12
<b>FMVSS</b>	P2		
<b>MATERIALS</b>	Acrylic lens, ABS housing		
<b>VOLT/AMP</b>	12.8VDC - 0.2A		
<b>WT/DIMS</b>	.066 lbs. / 2.5" x 2.5" x 1.063"		
<b>WARRANTY</b>	Three Year Warranty		

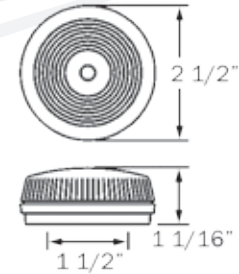

**optronics**



## MC66 SERIES Surface Mount Dual Bulb Marker/Clearance Lights

- Surface mount on 3" centers
- Includes both lead and ground wires
- Snap-on lens, replaceable bulb



BULK P/N	POLYPACK P/N	DESCRIPTION	QTY
<b>YELLOW</b>			
MC66AB	MC66ABP	Yellow	50
MC66HAB	MC66HABP	Yellow, single wire, self grounding	50
<b>RED</b>			
MC66RB	MC66RBP	Red	50
<b>ACCESSORIES</b>			
A66AB	A66ABP	Yellow replacement lens	50
A66RB	A66RBP	Red replacement lens	50
A194B	A194BP	194 replacement bulb	100
<b>RETAIL</b>			
MC66AS		Yellow light, clam	12
MC66RS		Red light, clam	12
<b>FMVSS</b>	P2 PC		
<b>MATERIALS</b>	Acrylic lens, ABS housing		
<b>VOLT/AMP</b>	12.8VDC - 0.4A		
<b>WT/DIMS</b>	.132 lb. / 4" x 2.063" x 1.063"		
<b>WARRANTY</b>	Three Year Warranty		

**optronics**

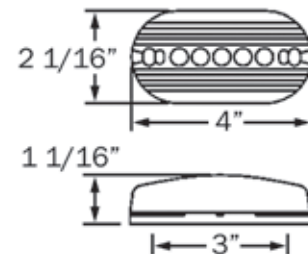
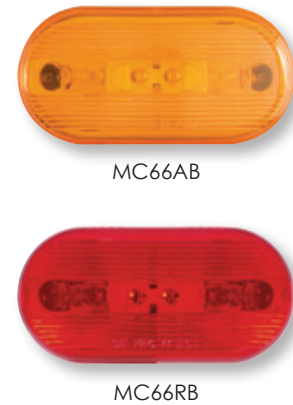

SURFACE MOUNT  
MARKER/CLEARANCE LIGHTS



## MC68 SERIES Oblong Marker/Clearance Lights



MC68AB



MC68RB

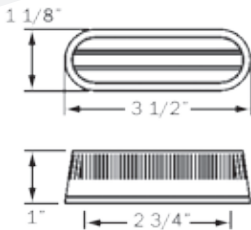

- Surface mount on 2-3/4" centers
- Single wire design grounds through mounting hardware
- Snap-on lens, replaceable bulb

BULK P/N	POLYPACK P/N	DESCRIPTION	QTY
<b>YELLOW</b>			
MC68AB	MC68ABP	Yellow, self grounding	50
<b>RED</b>			
MC68RB	MC68RBP	Red, self grounding	50
<b>ACCESSORIES</b>			
A68AB	A68ABP	Yellow replacement lens	10
A68RB	A68RBP	Red replacement lens	10
<b>RETAIL</b>			
MC68AS		Yellow light, clam	12
MC68RS		Red light, clam	12

FMVSS	P2
MATERIALS	Acrylic lens, ABS housing
VOLT/AMP	12.8VDC - 0.2A
WT/DIMS	.088 lb. / 3.5" x 1.125" x 1"
WARRANTY	Three Year Warranty

SURFACE MOUNT  
MARKER/CLEARANCE LIGHTS



## MC70 SERIES Marker/Clearance Lights with Reflex



MC70AB



MC70RB

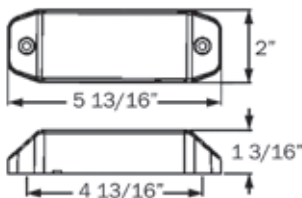

- Surface mount on 4-13/16" centers
- Lens with reflex eliminates need for separate reflector
- Weathertight plug included

BULK P/N	POLYPACK P/N	DESCRIPTION	QTY
<b>YELLOW</b>			
MC70AB	MC70ABP	Yellow	20
<b>RED</b>			
MC70RB	MC70RBP	Red	20

FMVSS	A P2
MATERIALS	Acrylic lens, plastic housing
VOLT/AMP	12.8VDC - 0.422A
WT/DIMS	.132 lb. / 5.813" x 2" x 1.188"
WARRANTY	Three Year Warranty

## MC71 SERIES Marker/Clearance Lights

- Flush mount on 2" centers; chrome finish bezel
- Twist-in socket, includes both lead and ground wire
- Replaceable bulb

BULK P/N	POLYPACK P/N	DESCRIPTION	QTY
<b>RETAIL</b>			
MC71AS		Yellow light, clam	12
MC71RS		Red light, clam	12
<b>ACCESSORIES</b>			
A194B	A194BP	194 replacement bulb	100

<b>FMVSS</b>	P2
<b>MATERIALS</b>	Acrylic lens, ABS housing and bezel
<b>VOLT/AMP</b>	12.8VDC - 0.4A
<b>WT/DIMS</b>	.132 lb. / 3.75" x 2.25" x 0.5"
<b>WARRANTY</b>	Three Year Warranty



MC71AS



MC71RS

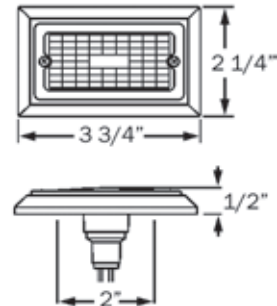

SURFACE MOUNT  
MARKER/CLEARANCE LIGHTS

## MC76 SERIES Marker/Clearance Light with Reflex

- Dual bulb light with built-in reflex
- Lens with reflex eliminates need for separate reflector
- Surface mount on 4-13/16" centers
- Hard wired, single wire design is self grounding

BULK P/N	POLYPACK P/N	DESCRIPTION	QTY
<b>YELLOW</b>			
MC76AB	MC76ABP	Yellow	50
<b>ACCESSORIES</b>			
A194B	A194BP	194 replacement bulb	100

<b>FMVSS</b>	A P2
<b>MATERIALS</b>	Acrylic lens, ABS housing
<b>VOLT/AMP</b>	12.8VDC - 1.0A
<b>WT/DIMS</b>	.132 lb. / 6" x 2.063" x 1"
<b>WARRANTY</b>	Three Year Warranty



MC76AB

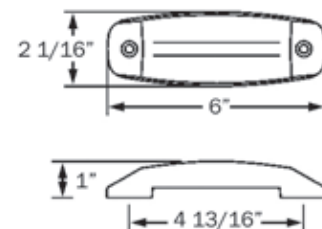



## MC81 SERIES

### Chrome Marker/Clearance Lights

- Surface mount on 3-7/8" centers
- Single wire design grounds through mounting hardware
- Replaceable lens and bulb





MC81AB

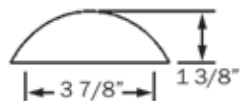
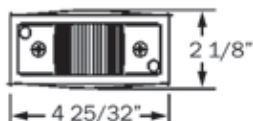

MC81RB



SURFACE MOUNT  
MARKER/CLEARANCE LIGHTS

BULK P/N	POLYPACK P/N	DESCRIPTION	QTY
<b>YELLOW</b>			
MC81AB	MC81ABP	Yellow, self grounding	50
<b>RED</b>			
MC81RB	MC81RBP	Red, self grounding	50
<b>ACCESSORIES</b>			
A194B	A194BP	194 replacement bulb	100
<b>RETAIL</b>			
MC81AS		Yellow light, clam	12
MC81RS		Red light, clam	12

<b>FMVSS</b>	P2
<b>MATERIALS</b>	Acrylic lens, ABS housing
<b>VOLT/AMP</b>	12.8VDC - 0.2A
<b>WT/DIMS</b>	.176 lb. / 4.781" x 2.125" x 1.375"
<b>WARRANTY</b>	Three Year Warranty



## MC82 SERIES

### Armored Marker/Clearance Lights

- Surface mount on 3-7/8" centers
- Single wire design grounds through mounting hardware
- Replaceable lens and bulb



MC82AB



MC82RB

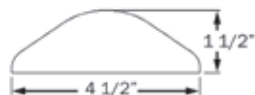
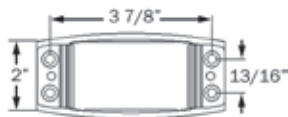

BULK P/N	POLYPACK P/N	DESCRIPTION	QTY
<b>YELLOW</b>			
MC82AB	MC82ABP	Yellow	20
<b>RED</b>			
MC82RB	MC82RBP	Red	20
<b>ACCESSORIES</b>			
A82AB	A82ABP	Yellow replacement lens	50
A82RB	A82RBP	Red replacement lens	50
A194B	A194BP	194 replacement bulb	100

<b>FMVSS</b>	P2 PC
<b>MATERIALS</b>	Acrylic lens, painted steel housing
<b>VOLT/AMP</b>	12.8VDC - 0.2A
<b>WT/DIMS</b>	.441 lb. / 4.5" x 2" x 1.5"
<b>WARRANTY</b>	Three Year Warranty

## MC85 SERIES Sealed Marker/Clearance Light

- Sonically sealed, waterproof
- Surface mount on 2-3/4" centers
- Hard wired, single wire design is self grounding

BULK P/N	POLYPACK P/N	DESCRIPTION	QTY
<b>YELLOW</b>			
MC85AB	MC85ABP	Yellow	50

FMVSS	P2 P3
MATERIALS	Polycarbonate lens and housing
VOLT/AMP	12.8VDC - 0.2A
WT/DIMS	.066 lb. / 3.188" x 1.063" x 1.063"
WARRANTY	Three Year Warranty

**Optronics**



MC85AB

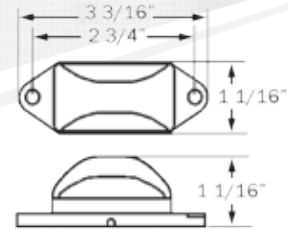

## MC95 SERIES Sealed Marker/Clearance Lights

- Sonically sealed, waterproof
- Stainless steel base
- Single wire design grounds through mounting hardware

BULK P/N	POLYPACK P/N	DESCRIPTION	QTY
<b>YELLOW</b>			
MC95AB	MC95ABP	Yellow	50
MC95APG	-	Yellow, .180 male bullet	50

<b>RED</b>			
MC95RB	MC95RBP	Red	50

<b>RETAIL</b>			
MC95AS		Yellow light, clam	12
MC95RS		Red light, clam	12

FMVSS	P2 P3
MATERIALS	Polycarbonate lens and housing, stainless steel base
VOLT/AMP	12.8VDC - 0.2A
WT/DIMS	.088 lb. / 2.063" x .688" x 1"
WARRANTY	Three Year Warranty

**Optronics**



MC95AB



MC95RB

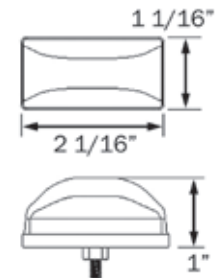

SURFACE MOUNT  
MARKER/CLEARANCE LIGHTS



## CB11WAB Yellow Cab/Clearance Light

- White base, mounts on 3" centers
- Replaceable lens and bulb (67 bulb)
- Includes both lead and ground wires



CB11WAB

BULK P/N	POLYPACK P/N	DESCRIPTION	QTY
<b>CAB/CLEARANCE LIGHT</b>			
CB11WAB	CB11WABP	Yellow, white base	50

FMVSS	P2 PC
MATERIALS	Acrylic lens, ABS housing
VOLT/AMP	12.8VDC - 0.569A
WT/DIMS	.265 lb. / 5.5" x 2.375" x 1.625"
WARRANTY	Three Year Warranty

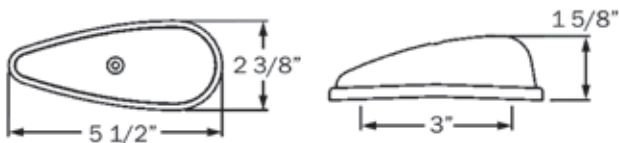

SURFACE MOUNT  
MARKER/CLEARANCE LIGHTS



## CB11AS/CB15AK Yellow Cab/Clearance Lights

- Black base, mounts on 3" centers
- Replaceable lens and bulb (67 bulb)
- Single wire design, self grounding



CB11AS



CB15AK

BULK P/N	POLYPACK P/N	DESCRIPTION	QTY
<b>RETAIL</b>			
CB11AS		Cab light, clam	12
CB15AK		5-pc cab light kit, clam	6

FMVSS	P2 PC
MATERIALS	Acrylic lens, ABS housing
VOLT/AMP	12.8VDC - 0.569A
WT/DIMS	CB11: .176 lb. / 5.5" x 2.375" x 1.625" CB15: 1.191 lbs. / 5.5" x 2.375" x 1.625"
WARRANTY	Three Year Warranty

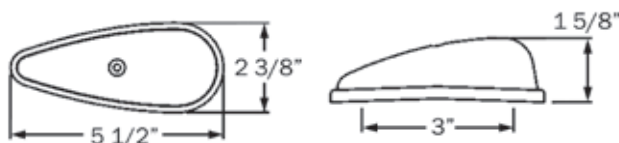

## CB20AB

### Yellow Cab/Clearance Light

- Surface mount on 1-1/2" centers, gasket included
- Sealed polycarbonate lens and housing
- Includes both lead and ground wires

**PC Rated**

BULK P/N	POLYPACK P/N	DESCRIPTION	QTY
<b>CAB/CLEARANCE LIGHT</b>			

CB20AB	CB20ABP	Yellow	50
--------	---------	--------	----

<b>RETAIL</b>			
CB20AS		Yellow, clam	12



FMVSS	P2 PC
MATERIALS	Acrylic lens, ABS housing
VOLT/AMP	12.8VDC - 0.2A
WT/DIMS	.265 lb. / 3.5" x 2.75" x 1.688"
WARRANTY	Three Year Warranty

**optronics**



CB20AB

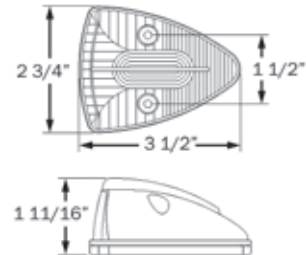

SURFACE MOUNT  
MARKER/CLEARANCE LIGHTS

## CB22 SERIES

### Cab/Clearance Lights

**PC Rated**

- Surface mount on 1-3/4" centers, gasket included
- Sealed polycarbonate lens and housing
- Twist-in socket with both lead and ground wires

BULK P/N	POLYPACK P/N	DESCRIPTION	QTY
<b>YELLOW</b>			

CB22AB	CB22ABP	Yellow	50
--------	---------	--------	----

<b>RED</b>			
CB22RB	CB22RBP	Red	50

<b>ACCESSORIES</b>			
A194B	A194BP	194 replacement bulb	100

<b>RETAIL</b>			
CB22AS		Yellow, clam	12



FMVSS	P2 PC
MATERIALS	Polycarbonate lens and housing
VOLT/AMP	12.8VDC - 0.2A
WT/DIMS	.132 lb. / 3.875" x 3.125" x 1.625"
WARRANTY	Three Year Warranty

**optronics**



CB22AB



CB22RB

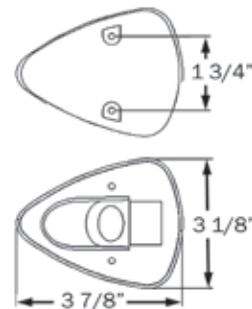

**optronics**



## MC77RB Identification Light Bar



MC77RB

- Steel base with white finish
- Surface mount on 7" centers
- Snap-on lens and replaceable bulb
- Single wire design, self grounding

BULK P/N	POLYPACK P/N	DESCRIPTION	QTY
<b>RED ID LIGHT BAR</b>			
MC77RB	MC77RBP	ID light bar	20
<b>ACCESSORIES</b>			
A68RB	A68RBP	Red replacement lens	10
FMVSS	P2		
MATERIALS	Acrylic lens, ABS housing, steel base		
VOLT/AMP	12.8VDC - 1.0A (193 bulb)		
WT/DIMS	.265 lb. / 15.563" x 1.188" x 1.313"		
WARRANTY	Three Year Warranty		

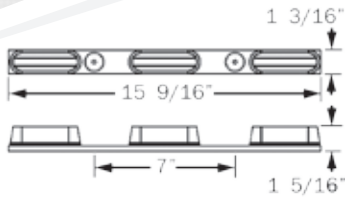

IDENTIFICATION LIGHT BARS



## MC93 SERIES Sealed Identification Light Bars

MC93AB



MC93RB

- Surface mount on 7-1/2" centers
- Sealed, waterproof lights
- Hard wired, power and ground

BULK P/N	POLYPACK P/N	DESCRIPTION	QTY
<b>YELLOW</b>			
MC93AB	MC93ABP	Yellow	20
<b>RED</b>			
MC93RB	MC93RBP	Red	20
MC93RPG	MC93RPGP	Red, .180 male bullet on power wire	20
MC93R2PG	MC93R2PGP	Red, .180 male bullets on both wires	20
<b>ACCESSORIES</b>			
A91AB	A91ABP	Yellow replacement light	100
A91RB	A91RBP	Red replacement light	100
A93PB	A93PBP	Harness for light bar	100
<b>RETAIL</b>			
MC93RK		Red ID light bar, clam	6
FMVSS	P2		
MATERIALS	Polycarbonate lens and housing, ABS base		
VOLT/AMP	12.8VDC - 1.0A		
WT/DIMS	.397 lb. / 17" x 1.438" x 1.625"		
WARRANTY	Three Year Warranty		

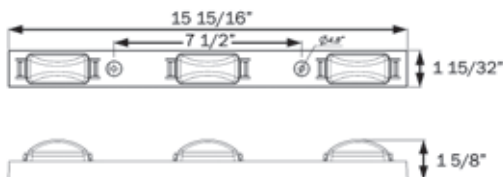



## MC94RB

### Identification Light Bar

- Stainless steel base
- Surface mount on 16-1/16" centers
- Sealed, waterproof lights
- Hard wired, power and ground



MC94RB

BULK P/N	POLYPACK P/N	DESCRIPTION	QTY
<b>RED ID LIGHT BAR</b>			
MC94RB	MC94RBP	ID light bar	20
<b>ACCESSORIES</b>			
A91RB	A91RBP	Red replacement light	100
A93PB	A93PBP	Harness for light bar	100
<b>FMVSS</b>	P2		
<b>MATERIALS</b>	Polycarbonate lens and housing, stainless steel base		
<b>VOLT/AMP</b>	12.8VDC - 1.0A		
<b>WT/DIMS</b>	.441 lb. / 16.5" x 1.375" x 1.625"		
<b>WARRANTY</b>	Three Year Warranty		

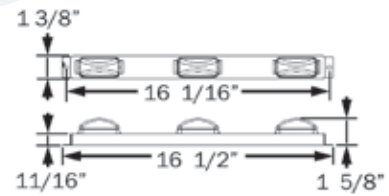

IDENTIFICATION LIGHT BARS

## MC97 SERIES

### Sealed Identification Light Bars

- Stainless steel base
- Surface mount on 8-1/2" centers
- Sealed, waterproof lights
- Single wire, self grounding



MC97RB

BULK P/N	POLYPACK P/N	DESCRIPTION	QTY
<b>RED ID LIGHT BARS</b>			
MC97RB	MC97RBP	Red	20
MC97R70PG	-	Red, .156 female plug, 70" lead	20
MC97RTTG	-	Red, .180 female plug	50
<b>CLEAR UTILITY LIGHT</b>			
UL97CPG	UL97CPGP	Clear	50
<b>ACCESSORIES</b>			
MC95RB	MC95RBP	Red replacement light	50
<b>RETAIL</b>			
MC97RK		Red ID light bar, clam	6

<b>FMVSS</b>	P2		
<b>MATERIALS</b>	Polycarbonate lens and housing, stainless steel base		
<b>VOLT/AMP</b>	12.8VDC - 1.0A		
<b>WT/DIMS</b>	.441 lb. / 14.25" x 1.188" x 1.313"		
<b>WARRANTY</b>	Three Year Warranty		

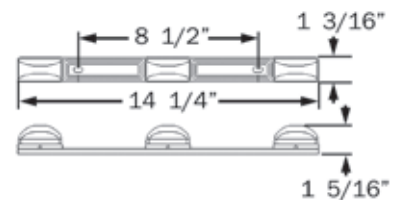



## MC99 SERIES Identification Light Bars

MC99AB





MC99RB

- Steel base with white finish
- Surface mount on 14-3/8" centers
- Snap-on lens, replaceable bulbs
- Single wire, self grounding

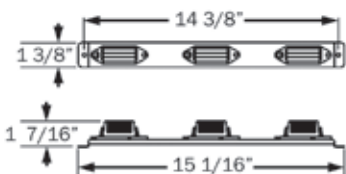
IDENTIFICATION  
LIGHT BARS



BULK P/N	POLYPACK P/N	DESCRIPTION	QTY
<b>YELLOW</b>			
MC99AB	MC99ABP	Yellow	20
<b>RED</b>			
MC99RB	MC99RBP	Red	20
<b>ACCESSORIES</b>			
A11AB	A11ABP	Yellow replacement lens	50
A11RB	A11RBP	Red replacement lens	50
A194B	A194BP	194 replacement bulb	100
<b>RETAIL</b>			
MC99AK		Yellow ID light bar, clam	6
MC99RK		Red ID light bar, clam	6

FMVSS	P2
MATERIALS	Acrylic lens, ABS housing, steel base
VOLT/AMP	12.8VDC - 1.0A
WT/DIMS	.353 lb. / 15.063" x 1.375" x 1.438"
WARRANTY	Three Year Warranty



## RB10A Magnet Mount Rotary Beacon



RB10A

- 12V rotary beacons for magnet mount
- 10-ft coil cord with power plug
- Replaceable bulb

BULK P/N	DESCRIPTION	QTY
<b>RETAIL</b>		
RB10A	Yellow rotary beacon, clam	 6

MATERIALS	Acrylic lens
VOLT/AMP	12.8VDC - 1.45A
WT/DIMS	1.6 lb. / 4.75" x 4.75" x 5.25"
WARRANTY	Three Year Warranty

## LP11 SERIES

### Snap-In Mini License Plate Lights

- Chrome plated brass construction
- Easy snap-in mounting
- Replaceable bulb (67)
- Single wire, self grounding

BULK P/N	POLYPACK P/N	DESCRIPTION	QTY
<b>LICENSE LIGHTS</b>			
LP11CB	LP11CBP	License light	50
LP11CPG	LP11CPGP	License light, .180 male bullet	50
<b>RETAIL</b>			
LP11CS		License light, clam	12

FMVSS	(2) L
MATERIALS	Brass, chrome plated
VOLT/AMP	12.8VDC - 0.4A
WT/DIMS	.066 lb. / 1.5" x 1.5" x 2"
WARRANTY	Three Year Warranty

**optronics**



LP11CB

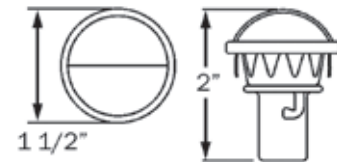

LICENSE/UTILITY LIGHTS

## LP21 SERIES

### Heavy Duty License Plate Lights

- Armored light made of durable chrome plated steel
- Surface mount on 2" centers
- Replaceable bulb (67)
- Single wire, self grounding

BULK P/N	POLYPACK P/N	DESCRIPTION	QTY
<b>LICENSE LIGHTS</b>			
LP21CB	LP21CBP	License light	50
<b>RETAIL</b>			
LP21CS		License light, clam	12

FMVSS	L
MATERIALS	Brass, chrome plated
VOLT/AMP	12.8VDC - 0.2A
WT/DIMS	.132 lb. / 2.5" x 1.813" x 2"
WARRANTY	Three Year Warranty

**optronics**



LP21CB

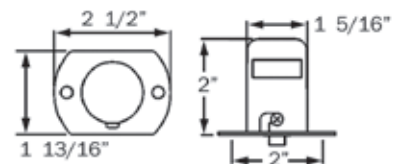



## LP31 SERIES Mini License Plate Light

- Surface mount on 2" centers
- Replaceable bulb
- Two-wire design includes both lead and ground wire



LP31CB



LPB31CPG

LICENSE/UTILITY LIGHTS

BULK P/N	POLYPACK P/N	DESCRIPTION	QTY
<b>LICENSE LIGHTS</b>			
LP31CB	LP31CBP	License light	50
LP31CPG	LP31CPGP	License light, .156 female barrels	50
LPB31CPG	LPB31CPGP	License light mounted on black plastic bracket, .156 female barrels	25
<b>ACCESSORIES</b>			
A194B	A194BP	194 replacement bulb	100
<b>RETAIL</b>			
LP31CS		License light, clam	12

FMVSS	(2) L
MATERIALS	Brass, chrome plated bezel; stainless steel bulb socket
VOLT/AMP	12.8VDC - 0.261A
WT/DIMS	.088 lb. / 2.563" x 1.25" x 1" (light only)
WARRANTY	Three Year Warranty

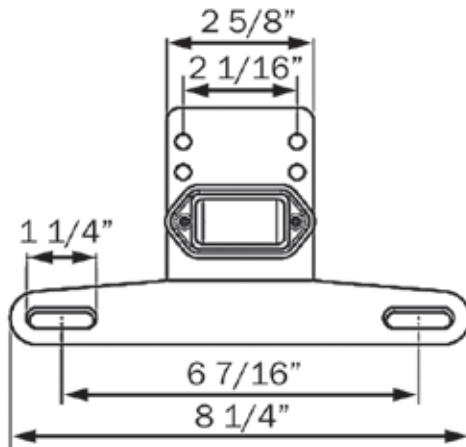

LPB31CPG

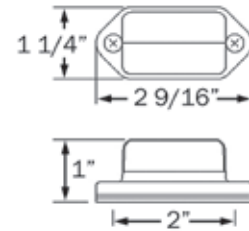
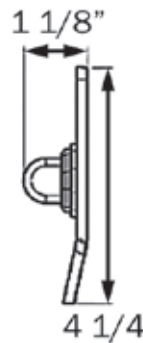

LP31CB

## LP41 SERIES Stud Mount License Plate Light

- Chrome plated cover, black base
- Stud mount on 1-3/4" centers
- Replaceable bulb
- Single wire, self grounding

BULK P/N	POLYPACK P/N	DESCRIPTION	QTY
<b>LICENSE LIGHTS</b>			
LP41CB	LP41CBP	License light	50
<b>ACCESSORIES</b>			
A194B	A194BP	194 replacement bulb	100
<b>RETAIL</b>			
LP41CS		License light, clam	12

FMVSS	L
MATERIALS	Brass, chrome plated
VOLT/AMP	12.8VDC - 0.2A
WT/DIMS	.11 lb. / 2.625" x 1.563" x 2.188"
WARRANTY	Three Year Warranty

**optronics**



LP41CB

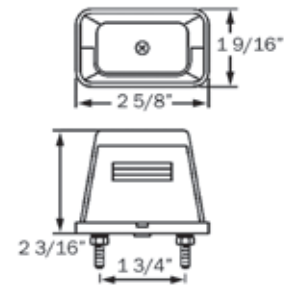

LICENSE/UTILITY LIGHTS

## LP51 SERIES Surface Mount License Plate Light

- Gray coated cover, stainless steel mounting base
- Stud mount on 3-1/4" centers
- Replaceable bulb
- Single wire, self grounding

BULK P/N	POLYPACK P/N	DESCRIPTION	QTY
<b>LICENSE LIGHTS</b>			
LP51CB	LP51CBP	License light	20
<b>ACCESSORIES</b>			
A194B	A194BP	194 replacement bulb	100

FMVSS	L
MATERIALS	Stainless steel mounting base, plastic cover
VOLT/AMP	12.8VDC - 0.2A
WT/DIMS	.309 lb. / 4" x 1.75" x 2.313"
WARRANTY	Three Year Warranty

**optronics**



LP51CB

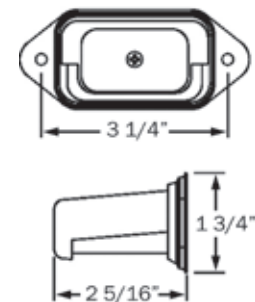



## LP52/54 SERIES

### License Plate Light with Bracket



LP52CB

- Light features gray coated cover, stainless steel mounting base; bracket is steel with black finish
- Surface mount on 3.5" centers, hardware included
- Replaceable bulb

BULK P/N	POLYPACK P/N	DESCRIPTION	QTY
<b>LICENSE LIGHTS</b>			
LP52CB	LP52CBP	License light, single wire	10
LP54CB	LP54CBP	License light, two-wire	10
<b>ACCESSORIES</b>			
LP52HP	LP52HPP	Mounting hardware	100
A194B	A194BP	194 replacement bulb	100

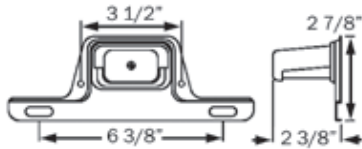

FMVSS	L
MATERIALS	Stainless steel mounting base, plastic cover, steel bracket
VOLT/AMP	12.8VDC - 0.2A
WT/DIMS	.309 lb. / 8.5" x 2.875" x 2.375"
WARRANTY	Three Year Warranty

LICENSE/UTILITY LIGHTS



## LP55 SERIES

### License Plate Light with Bracket



LP55CB

- Light features gray coated cover, stainless steel mounting base; bracket is black heavy duty plastic
- Surface mount on 6-7/16" centers
- Includes both lead and ground wires
- Replaceable bulb (67)

BULK P/N	POLYPACK P/N	DESCRIPTION	QTY
<b>LICENSE LIGHTS</b>			
LP55CB	LP55CBP	License light	10

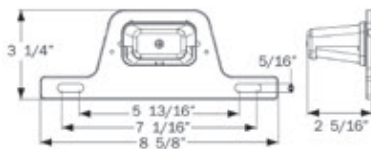

FMVSS	L
MATERIALS	Stainless steel mounting base, plastic cover, plastic bracket
VOLT/AMP	12.8VDC - 0.2A
WT/DIMS	.176 lb. / 8.625" x 3.25" x 2.313"
WARRANTY	Three Year Warranty

## LP56 SERIES

### Surface Mount License Plate Light

- Surface mount with included adhesive
- Replaceable bulb (67)
- Single wire, self grounding

BULK P/N	POLYPACK P/N	DESCRIPTION	QTY
<b>LICENSE LIGHTS</b>			
LP56CB	LP56CBP	License light	50

<b>FMVSS</b>	L
<b>MATERIALS</b>	Gray plastic housing
<b>VOLT/AMP</b>	12.8VDC - 0.2A
<b>WT/DIMS</b>	.11 lb. / 2.625" x 1.625" x 2"
<b>WARRANTY</b>	Three Year Warranty



LP56CB

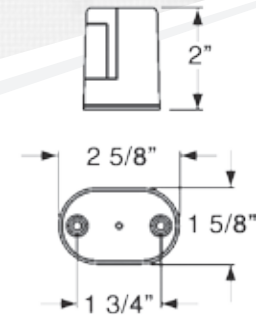

LICENSE/UTILITY LIGHTS

## LP65 SERIES

### Sealed License Plate Light

- Sonically sealed, waterproof
- Multiple mounting and wiring options

BULK P/N	POLYPACK P/N	DESCRIPTION	QTY
<b>LICENSE LIGHTS</b>			
LP65CB	LP65CBP	License light	50

<b>ACCESSORIES</b>			
A65B	A65BP	Black bracket	50
A65P	A65PP	Single wire plug, .156 male bullet	50
A65PB	A65PBP	Kit: A65B black bracket & A65P plug	50
A66PB	A66PBP	Kit: Gray bracket & A65P plug	50
A67CB	A67CBP	Kit: Chrome bracket & A65P plug	50
A68PB	A68PBP	Kit: Black bracket & 2-wire plug	50

For more details on mounting and wiring accessories, see Accessories section at back of catalog.

<b>FMVSS</b>	L
<b>MATERIALS</b>	Polycarbonate lens and housing
<b>VOLT/AMP</b>	12.8VDC - 0.656A
<b>WT/DIMS</b>	.066 lb. / 3.938" x 1.25" x 0.875"
<b>WARRANTY</b>	Three Year Warranty



LP65CB

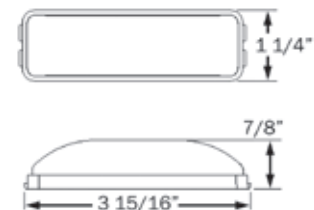





## LP71 SERIES Chrome License Plate Light

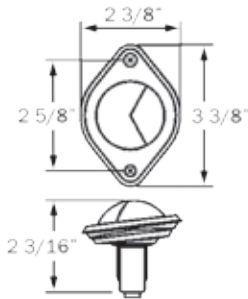

LP71CB

- Chrome-plated brass and steel housing
- Mount on 2-5/8" centers
- Replaceable bulb (67)
- Single wire, self grounding
- Two units required for legal license illumination



BULK P/N	POLYPACK P/N	DESCRIPTION	QTY
<b>LICENSE LIGHTS</b>			
LP71CB	LP71CBP	License light	25
<b>RETAIL</b>			
LP71CS		License light, clam	12

FMVSS	(2) L
MATERIALS	Brass and stainless steel housing
VOLT/AMP	12.8VDC - 0.2A
WT/DIMS	.058 lb. / 3.375" x 2.375" x 2.188"
WARRANTY	Three Year Warranty

LICENSE/UTILITY LIGHTS



## LP81 SERIES Surface Mount License Plate Light



LP81BB

- Surface mount on 3-7/16" centers
- Replaceable bulb
- Includes both lead and ground wires
- Available in standard black and optional gray color

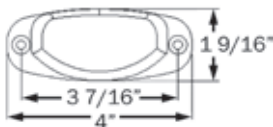

BULK P/N	POLYPACK P/N	DESCRIPTION	QTY
<b>LICENSE LIGHTS</b>			
LP81BB	LP81BBP	License light	50
LP81BPG	-	License light, .180 male plug on power, ground eyelet on ground	50
LP81GB	-	License light, gray housing	50

<b>ACCESSORIES</b>			
A194B	A194BP	194 replacement bulb	100

FMVSS	L
MATERIALS	Polycarbonate housing
VOLT/AMP	12.8VDC - 0.2A
WT/DIMS	.11 lb. / 4" x 1.563" x 2.625"
WARRANTY	Three Year Warranty



## LP97 SERIES

### Sealed License/Utility Light

- Sonically sealed, waterproof
- Terminal is two .156 female barrels

BULK P/N	POLYPACK P/N	DESCRIPTION	QTY
<b>LICENSE LIGHTS</b>			
LP97CB	LP97CBP	License light	50

FMVSS	L
MATERIALS	Polycarbonate lens and housing
VOLT/AMP	12.8VDC - 0.2A
WT/DIMS	.11 lb. / 3.375" x 1.25" x 2.375"
WARRANTY	Three Year Warranty

**optronics**



LP97CB

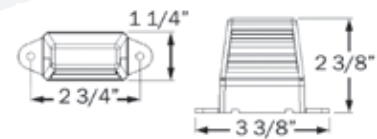

LICENSE/UTILITY LIGHTS

## LP95CBF

### Sealed Stud Mount License/Utility Light

- Sonically sealed, waterproof
- Design includes both lead and ground wires with .180 female barrels

BULK P/N	POLYPACK P/N	DESCRIPTION	QTY
<b>LICENSE/UTILITY LIGHTS</b>			
LP95CBF	-	License/utility light	50

MATERIALS	Polycarbonate lens and housing, stainless steel base
VOLT/AMP	12.8VDC - 0.2A
WT/DIMS	.066 lb. / 2.063" x .688" x 1"
WARRANTY	Three Year Warranty

**optronics**

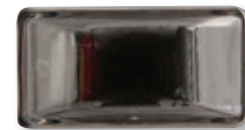

LP95CBF

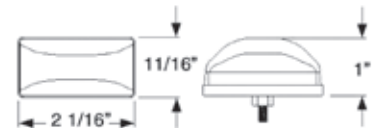



## LP85 SERIES Sealed License/Utility Light



LP85CB

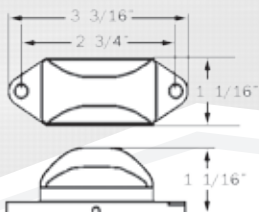

- Sonically sealed, waterproof
- Single wire design grounds through mounting hardware

BULK P/N	POLYPACK P/N	DESCRIPTION	QTY
<b>LICENSE/UTILITY LIGHTS</b>			
LP85CB	LP85CBP	License/utility light	50

<b>MATERIALS</b>	Polycarbonate lens and housing
<b>VOLT/AMP</b>	12.8VDC - 0.2A
<b>WT/DIMS</b>	.066 lb. / 3.188" x 1.063" x 1.063"
<b>WARRANTY</b>	Three Year Warranty



## LP91 SERIES Sealed License/Utility Light



LP91CB

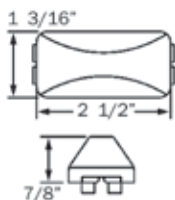

- Sonically sealed, waterproof
- Multiple mounting and wiring options

BULK P/N	POLYPACK P/N	DESCRIPTION	QTY
<b>LICENSE/UTILITY LIGHTS</b>			
LP91CB	LP91CBP	License/utility light	50
LP26SKB	LP26SKBP	Kit: LP91CB, LP25SGGB, gasket, .180 male bullets on power and ground	50

<b>LICENSE LIGHT BRACKET</b>			
LP25SB	LP25SBP	Vertical bracket, black coated	100

<b>ACCESSORIES</b>			
A46PB	A46PBP	2-wire plug, 6" lead	100
A86PB	A86PBP	2-wire plug, 18" lead	100
A91LW	A91LWP	1-wire plug, 12" lead	100
A91BB	A91BBP	Black base, self grounding	100
A91BOB	A91BOBP	Black base, open back	100
A91CB	A91CBP	Chrome base, self grounding	100
A91OB	A91OBP	Chrome base, open back	100
A91GB	A91GBP	Grommet	100



LP26SKB

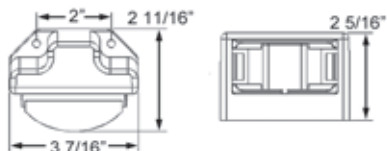

<b>MATERIALS</b>	Polycarbonate lens and housing
<b>VOLT/AMP</b>	12.8VDC - 0.2A
<b>WT/DIMS</b>	.066 lb. / 2.5" x 1.1885" x 0.875"
<b>WARRANTY</b>	Three Year Warranty

## UL94 SERIES

### Sealed Stud Mount License/Utility Light

- Sonically sealed, waterproof
- Polycarbonate housing, stainless steel base, clear lens
- Single wire design grounds through mounting hardware



UL94CB

BULK P/N	POLYPACK P/N	DESCRIPTION	QTY
<b>LICENSE/UTILITY LIGHT</b>			
UL94CB	UL94CBP	License/utility light	50

<b>MATERIALS</b>	Polycarbonate lens and housing, stainless steel base
<b>VOLT/AMP</b>	12.8VDC - 0.2A
<b>WT/DIMS</b>	.088 lb. / 2.125" x 1.125" x 1.063"
<b>WARRANTY</b>	Three Year Warranty

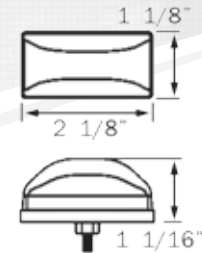

## UL95 SERIES

### Sealed Launch/Load Light

- Sonically sealed, waterproof
- Polycarbonate lens and housing
- Accepts standard two-pin PL-10 connector
- Multiple mounting and wiring options available



UL95CB

BULK P/N	POLYPACK P/N	DESCRIPTION	QTY
<b>LAUNCH/LOAD LIGHT</b>			
UL95CB	UL95CBP	Launch/load light	100

<b>ACCESSORIES</b>			
A46PB	A46PBP	2-wire plug, 6" lead	100
A86PB	A86PBP	2-wire plug, 18" lead	100
A91LW	A91LWP	1-wire plug, 12" lead	100
A91BB	A91BBP	Black base, self grounding	100
A91BOB	A91BOBP	Black base, open back	100
A91CB	A91CBP	Chrome base, self grounding	100
A91OB	A91OBP	Chrome base, open back	100
A91GB	A91GBP	Grommet	100

<b>MATERIALS</b>	Polycarbonate lens and housing
<b>VOLT/AMP</b>	12.8VDC - 0.4A
<b>WT/DIMS</b>	.066 lb. / 2.625" x 1.25" x 1.188"
<b>WARRANTY</b>	Three Year Warranty

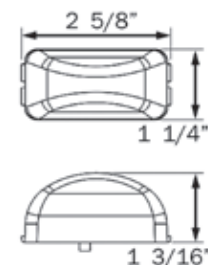



## UL97 SERIES Sealed Utility Light Bar



UL97CPG

- Sonically sealed, waterproof
- Polycarbonate lens and housing, stainless steel base
- Single wire design grounds through mounting hardware
- Plug-n-go connector

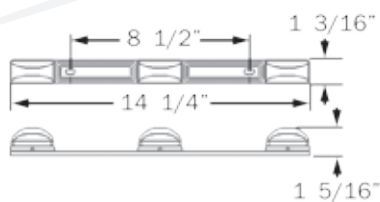

BULK P/N	POLYPACK P/N	DESCRIPTION	QTY
<b>UTILITY LIGHT</b>			
UL97CPG	UL97CPGP	Utility light bar	50

<b>MATERIALS</b>	Polycarbonate lens and housing, stainless steel base
<b>VOLT/AMP</b>	12.8VDC - 0.4A
<b>WT/DIMS</b>	.265 lb. / 14.25" x 1.188" x 1.313"
<b>WARRANTY</b>	Three Year Warranty

LICENSE/UTILITY LIGHTS



## UL71 SERIES Courtesy/Utility Light



UL71CS

- Chrome-plated ABS housing
- Twist-in bulb socket with lead and ground wires
- Replaceable bulb

BULK P/N	POLYPACK P/N	DESCRIPTION	QTY
<b>RETAIL</b>			
UL71CS		Utility light, clam	12
<b>ACCESSORIES</b>			
A194B	A194BP	194 replacement bulb	100

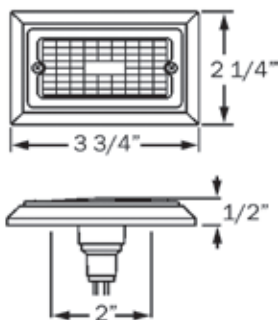

<b>MATERIALS</b>	Acrylic lens, ABS housing
<b>VOLT/AMP</b>	12.8VDC - 0.4A
<b>WT/DIMS</b>	.176 lb. / 3.75" x 2.25" x .5"
<b>WARRANTY</b>	Three Year Warranty

## UL53 SERIES 2" Sealed Utility Light

- Sonically sealed, waterproof
- Accepts standard two-pin PL-10 plug

BULK P/N	POLYPACK P/N	DESCRIPTION	QTY
<b>UTILITY LIGHT</b>			
UL53CB	UL53CBP	Utility light	100/50
<b>ACCESSORIES</b>			
A46PB	A46PBP	Straight plug, 6" lead	100
A86PB	A86PBP	Straight plug, 18" lead	100
A54GB	A54GBP	2" Flush mount grommet	100
A54GK	A54GKP	2" Kit: A54GB and A46PB	100
A55CB	A55CBP	2" Chrome trim ring	20
BK5557GB	BK5557GBP	Cam-on mounting bracket	50

<b>MATERIALS</b>	Polycarbonate lens and housing
<b>VOLT/AMP</b>	12.8VDC - 0.6A
<b>WT/DIMS</b>	.044 lb. / 2" x 2" x .688"
<b>WARRANTY</b>	Three Year Warranty

**optronics**



UL53CB

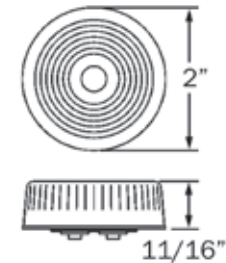

UTILITY/INTERIOR LIGHTS

## UL56 SERIES 2.5" Sealed Utility Light

- Sonically sealed, waterproof
- Accepts standard two-pin PL-10 plug
- Flush mount design with flange sealed to light

BULK P/N	POLYPACK P/N	DESCRIPTION	QTY
<b>UTILITY LIGHT</b>			
UL56CB	UL56CBP	Utility light	100/50
<b>ACCESSORIES</b>			
A46PB	A46PBP	Straight plug, 6" lead	100
A86PB	A86PBP	Straight plug, 18" lead	100

<b>MATERIALS</b>	Polycarbonate lens and housing
<b>VOLT/AMP</b>	12.8VDC - 0.6A
<b>WT/DIMS</b>	.044 lb. / 3.438" x 3.438" x .0938"
<b>WARRANTY</b>	Three Year Warranty

**optronics**



UL56CB

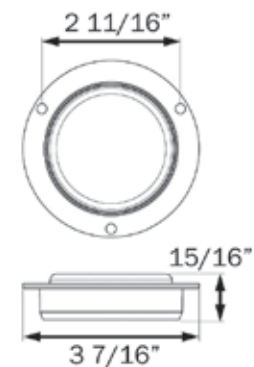





## IL21 SERIES Interior Dome Light

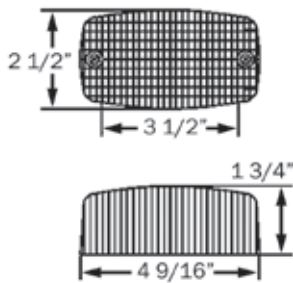

IL21CB

- Surface mount dome light with or without on/off switch
- Mounts on 3-1/2" centers
- Includes both lead and ground wire
- Replaceable bulb (1156)



BULK P/N	POLYPACK P/N	DESCRIPTION	QTY
<b>INTERIOR LIGHTS</b>			
IL21CB	IL21CBP	Interior light with switch, two-wire	50
IL21CPG	-	Interior light with switch, single wire with .180 male bullet	50
IL22CB	IL22CBP	Interior light without switch, two-wire	50
<b>RETAIL</b>			
IL21CS		Interior dome light with switch, clam	12

<b>MATERIALS</b>	Polycarbonate lens, steel base plate
<b>VOLT/AMP</b>	12.8VDC - 2.4A
<b>WT/DIMS</b>	.309 lb. / 4.563" x 2.5" x 1.75"
<b>WARRANTY</b>	Three Year Warranty

UTILITY/INTERIOR LIGHTS



## IL31CS Porch or Cabin Light



IL31CS

- Surface mount light with on/off switch
- Aluminum base, durable plastic lens
- Single wire design grounds through mounting hardware
- Replaceable bulb (1156)

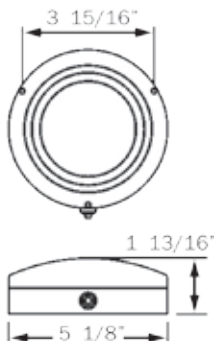

BULK P/N	POLYPACK P/N	DESCRIPTION	QTY
<b>RETAIL</b>			
IL31CS		Porch/cabin light, clam	6

<b>MATERIALS</b>	Plastic lens, aluminum housing
<b>VOLT/AMP</b>	12.8VDC - 2.2A
<b>WT/DIMS</b>	.375 lb. / 5.125" x 5.125" x 1.813"
<b>WARRANTY</b>	Three Year Warranty

## IL41 SERIES

### 4" Interior/Exterior Utility Light

- Flange mount light with steel housing and acrylic lens
- Includes both lead and ground wires
- Replaceable bulb (1142)



IL41CB

BULK P/N	POLYPACK P/N	DESCRIPTION	QTY
<b>INTERIOR/EXTERIOR LIGHT</b>			
IL41CB	IL41CBP	Interior light, two-wire	50

<b>MATERIALS</b>	Acrylic lens, steel housing
<b>VOLT/AMP</b>	12.8VDC - 1.5A
<b>WT/DIMS</b>	.441 lb. / 5.375" x 5.375" x 1.533"
<b>WARRANTY</b>	Three Year Warranty

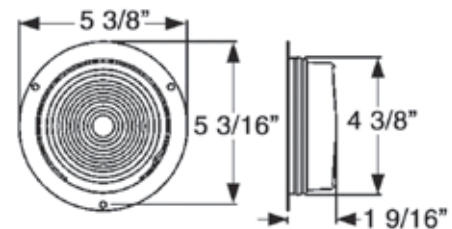

UTILITY/INTERIOR LIGHTS

## IL61 SERIES

### Dome Light with Switch

- Surface mount light with on/off switch
- Aluminum base, durable plastic lens
- Single wire design grounds through mounting hardware
- Replaceable bulb (1141)



IL61CB

BULK P/N	POLYPACK P/N	DESCRIPTION	QTY
<b>DOMELIGHT</b>			
IL61CB	IL61CBP	Dome light	50

<b>MATERIALS</b>	Plastic lens, aluminum housing
<b>VOLT/AMP</b>	12.8VDC - 0.4A
<b>WT/DIMS</b>	.221 lb. / 5.875" x 5.875" x 1.5"
<b>WARRANTY</b>	Three Year Warranty

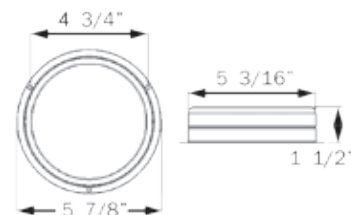



**IL91 SERIES**  
**6" Steel Dome Light**

- Surface mount steel base, chrome plated
- Includes both lead and ground wires
- Replaceable bulb (1141)



IL91CB

BULK P/N	POLYPACK P/N	DESCRIPTION	QTY
<b>DOMELIGHT</b>			
IL91CB	IL91CBP	Dome light	50

<b>MATERIALS</b>	Polycarbonate lens, steel housing
<b>VOLT/AMP</b>	12.8VDC - 0.4A
<b>WT/DIMS</b>	.485 lb. / 6.438" x 6.438" x 1.75"
<b>WARRANTY</b>	Three Year Warranty

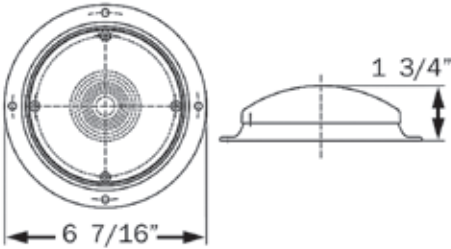

UTILITY/INTERIOR LIGHTS



## TL10 SERIES

### 5" Work Lights, Rubber Housings

- Utility/work/ag light with shock proof rubber housing
- #4411 sealed beam
- Include both lead and ground wires
- Steel bracket, 5/16" mounting post

BULK P/N	POLYPACK P/N	DESCRIPTION	QTY
<b>WORK/UTILITY/AG LIGHTS</b>			
TL10CB	TL10CBP	12V, 2-wire	25
TL10C24VB	TL10C24VBP	24V, 2-wire	25
TL11CPG	-	12V, self grounding, .180 male bullet	25
<b>RETAIL</b>			
TL10CS	12V Work/utility/ag light, clam		6
TL106CS	6V Work/utility/ag light, clam 		6
TL10SS	12V Work/utility/ag light, stainless steel bracket, clam		6
TL12CS	12V Work/utility/ag light, recessed bulb, clam		6

<b>MATERIALS</b>	Rubber housing, glass lens, steel bracket
<b>VOLT/AMP</b>	12.8VDC - 2.8A
<b>WT/DIMS</b>	1.235 lbs. / 4.75" x 4.75" x 2.5"
<b>WARRANTY</b>	Three Year Warranty





TL10CB

WORK/AG LIGHTS

## TL35/46 SERIES

### 55W Rectangular Utility/Ag Lights

- Utility/ag light with heavy duty plastic housing
- 12V 55W H3 halogen bulb
- Include both lead and ground wires
- Adjustable, steel mounting bracket

BULK P/N	POLYPACK P/N	DESCRIPTION	QTY
<b>UTILITY/AG LIGHTS</b>			
TL35TB	-	3" x 5" lens, trapezoid beam	20
<b>RETAIL</b>			
TL35FS	3" x 5" lens, flood beam, clam 		3
TL35TS	3" x 5" lens, trapezoid beam, clam		3
TL46FS	4" x 6" lens, flood beam, clam		3
TL46TS	4" x 6" lens, trapezoid beam, clam		3
A700	12V 55W H3 quartz halogen bulb, clam		12

<b>MATERIALS</b>	Plastic housing, glass lens, steel bracket
<b>VOLT/AMP</b>	12.8VDC - 4.5A
<b>WT/DIMS</b>	TL35: 1.5 lbs. / 6.5" x 4.375" x 3.75" TL46: 1.5 lbs. / 5.375" x 4.5" x 2.25"
<b>WARRANTY</b>	Three Year Warranty



TL35FS/TS



TL46FS/TS



## DL16 SERIES 55W Docking Lights



- Docking light with heavy duty plastic housing, glass lens
- 12V 55W H3 halogen bulb
- Includes both lead and ground wires with male bullets
- Stainless steel mounting bracket with rubber cover
- Kits include two lights, wiring, mounting hardware and switch



BULK P/N	POLYPACK P/N	DESCRIPTION	QTY
<b>RETAIL</b>			
DL16CC	Kit, black housing		3
DL16WC	Kit, white housing		3
A700	12V 55W H3 quartz halogen bulb, clam		12



<b>MATERIALS</b>	Plastic housing, glass lens, stainless steel bracket
<b>VOLT/AMP</b>	12.8VDC - 4.5A
<b>WT/DIMS</b>	0.663 lb. / 5.875" x 3" x 2.75"
<b>WARRANTY</b>	Three Year Warranty

HALOGEN LIGHTS



## DL55 SERIES 55W Marine Flood Lights



- Flood light with heavy duty plastic housing, glass lens
- 12V 55W H3 halogen bulb
- Includes both lead and ground wires
- Stainless steel mounting bracket

BULK P/N	POLYPACK P/N	DESCRIPTION	QTY
<b>RETAIL</b>			
DL55CS	55W marine flood light, clam		6
A700	12V 55W H3 quartz halogen bulb, clam		12



<b>MATERIALS</b>	Plastic housing, glass lens, stainless steel bracket
<b>VOLT/AMP</b>	12.8VDC - 4.5A
<b>WT/DIMS</b>	1.333 lb. / 6.25" x 4.25" x 3"
<b>WARRANTY</b>	Three Year Warranty

## QH16CTS & QH36CTS 55W Halogen Area Lights

- Area lights with post mount bases
- 12V 35W H3 halogen bulb
- Include both lead and ground wires
- QH36CTS has multi-directional bracket that adjusts both horizontally and vertically and stainless steel hardware

BULK P/N	POLYPACK P/N	DESCRIPTION	QTY
<b>AREA LIGHT</b>			
QH16CTS	QH16CTSP	Post mount area light	50
QH36CTS	QH36CTSP	Multi-directional post mount area light with stainless steel hardware	50
<b>RETAIL</b>			
A700	12V 55W H3 quartz halogen bulb, clam		12

<b>MATERIALS</b>	Plastic housing, glass lens
<b>VOLT/AMP</b>	12.8VDC - 4.5A
<b>WT/DIMS</b>	0.663 lb. / 5.875" x 3" x 2.75"
<b>WARRANTY</b>	Three Year Warranty

**optronics**



QH16CTS



QH36CTS

HALOGEN LIGHTS



## RVSTL0060/61 SERIES ONE™ LED Series RV Combination Tail Lights



RVSTL0060



RVSTL0061



RVSTLB0060



RVSTLB0061

- ONE™ LED Combination stop/turn/tail light with built-in reflex
- Driver side lights include LED license plate illuminator and mounting bracket
- Surface mount design with snap-on lens
- Available with white or black base
- Hard wired, ground wire included

BULK P/N	POLYPACK P/N	DESCRIPTION	QTY
<b>ONE™ LED RV COMBINATION TAIL LIGHTS</b>			
RVSTL0060	RVSTL0060P	Passenger side, white base	48
RVSTL0061	RVSTL0061P	Driver side, white base	48
RVSTLB0060	RVSTLB0060P	Passenger side, black base	48
RVSTLB0061	RVSTLB0061P	Driver side, black base	48
<b>ACCESSORIES</b>			
RV60BK	RV60BKP	Wedge base, white	100

<b>FMVSS</b>	A S2 T2 I6
<b>MATERIALS</b>	Acrylic lens and plastic housing
<b>VOLT/AMP</b>	RVSTL0060: 12.8VDC .34A Stop/Turn, .01A Tail RVSTL0061: 12.8VDC .43A Stop/Turn, .094A Tail
<b>WT/DIMS</b>	RVSTL0060 .456 lbs. / 8.688" x 3.188" x 2.25" RVSTL0061 .513 lbs. / 8.688" x 5" x 2.25"
<b>WARRANTY</b>	Lifetime LED Warranty

RV COMBINATION TAIL LIGHTS

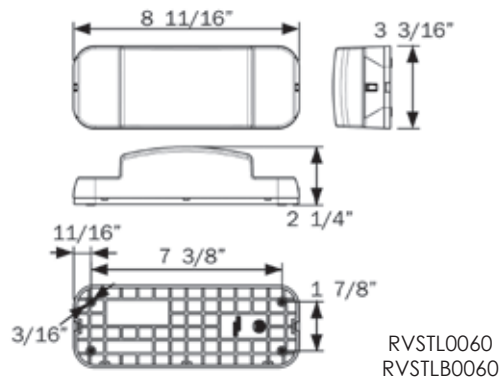
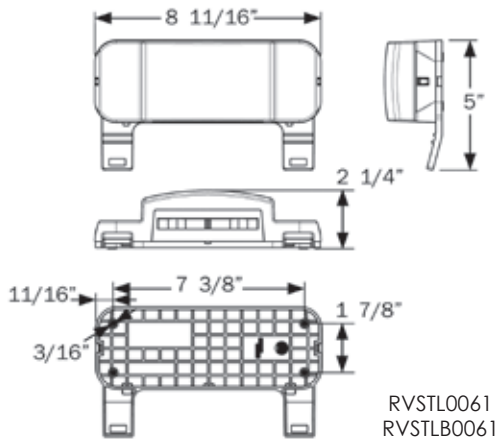

## RVSTL60/61 SERIES LED Low Profile RV Combination Tail Lights



- 9-LED combination stop/turn/tail light for surface mount
- Driver side lights include 3-LED license plate illuminator and mounting bracket
- Snap-on, replaceable lens
- Available with white or black base
- Hard wired, ground wire included



RVSTL60  
RVSTLB60



RVSTL61



RVSTLB61

BULK P/N	POLYPACK P/N	DESCRIPTION	QTY
<b>LED RV COMBINATION TAIL LIGHTS - 9 DIODES</b>			
RVSTL60	RVSTL60P	Passenger side, white base	48
RVSTL61	RVSTL61P	Driver side, white base	48
RVSTLB60	RVSTLB60P	Passenger side, black base	48
RVSTLB61	RVSTLB61P	Driver side, black base	48
<b>ACCESSORIES</b>			
RV60BK	RV60BKP	Wedge base mounting bezel, white	100
AST60B	AST60BP	Tail light lens, passenger side	10
AST61B	AST61BP	Tail light lens, driver side	10
<b>RETAIL</b>			
RVSTL60S	Passenger side, white base, clam		6
RVSTL61S	Driver side, white base, clam		6
<b>FMVSS</b>	A S2 T2 I6		
<b>MATERIALS</b>	Acrylic lens and plastic housing		
<b>VOLT/AMP</b>	12.8VDC - .243A Stop/Turn, .046A Tail		
<b>WT/DIMS</b>	RVSTL60: .419 lb. / 8.625" x 3.188" x 2.25"		
	RVSTL61: .419 lb. / 8.625" x 5" x 2.25"		
<b>WARRANTY</b>	Lifetime LED Warranty		

RV COMBINATION  
TAIL LIGHTS

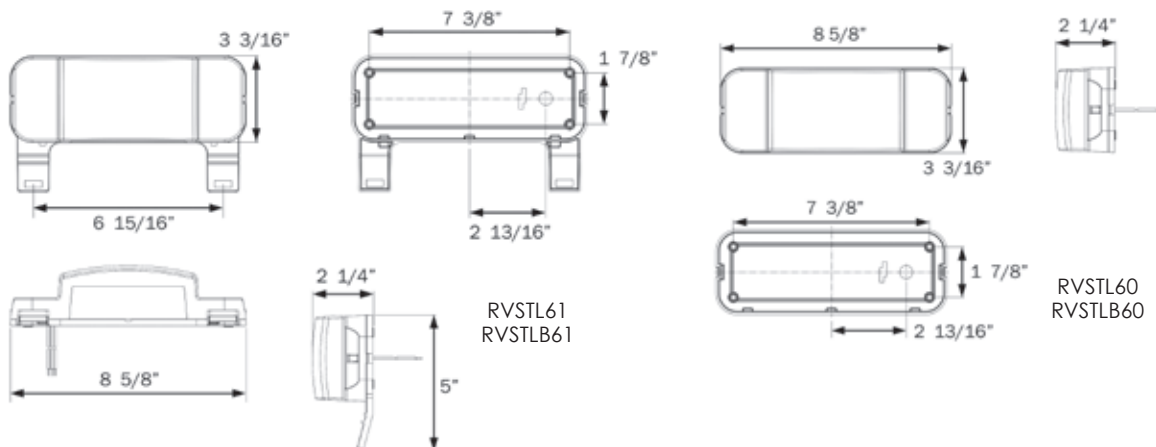



## RVST60/61 SERIES Low Profile RV Combination Tail Lights



RVST60  
RVSTB60



RVST61

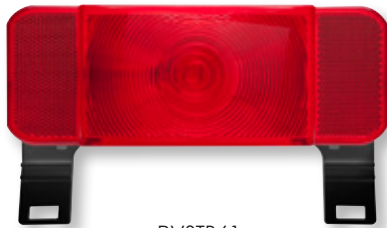

RVSTB61



RV60BK

- Combination stop/turn/tail light for surface mount
- Driver side lights include license plate illuminator and mounting bracket
- Snap-on lens and replaceable bulb
- Available with white or black base
- Hard wired, ground wire included

BULK P/N	POLYPACK P/N	DESCRIPTION	QTY
<b>RV COMBINATION TAIL LIGHTS</b>			
RVST60	RVST60P	Passenger side RV tail light, white base	48
RVST61	RVST61P	Driver side RV tail light, white base	48
RVSTB60	RVSTB60P	Passenger side RV tail light, black base	48
RVSTB61	RVSTB61P	Driver side RV tail light, black base	48
<b>ACCESSORIES</b>			
AST60B	AST60BP	Tail light lens, RVST60	10
AST61B	AST61BP	Tail light lens, RVST61	10
RV60BK	RV60BKP	Wedge base mounting bezel, white	100
A1157B	A1157BP	1157 replacement bulb	50
<b>RETAIL</b>			
RVST60S	Passenger side, white base, clam		6
RVST61S	Driver side, white base, clam		6
<b>FMVSS</b>	A S2 T2 I6		
<b>MATERIALS</b>	Acrylic lens and plastic housing		
<b>VOLT/AMP</b>	12.8VDC - 2.65A Stop, 2.10A Tail		
<b>WT/DIMS</b>	RVST60: .419 lb. / 8.625" x 3.188" x 2.25"		
	RVST61: .419 lb. / 8.625" x 5" x 2.25"		
<b>WARRANTY</b>	Three Year Warranty		

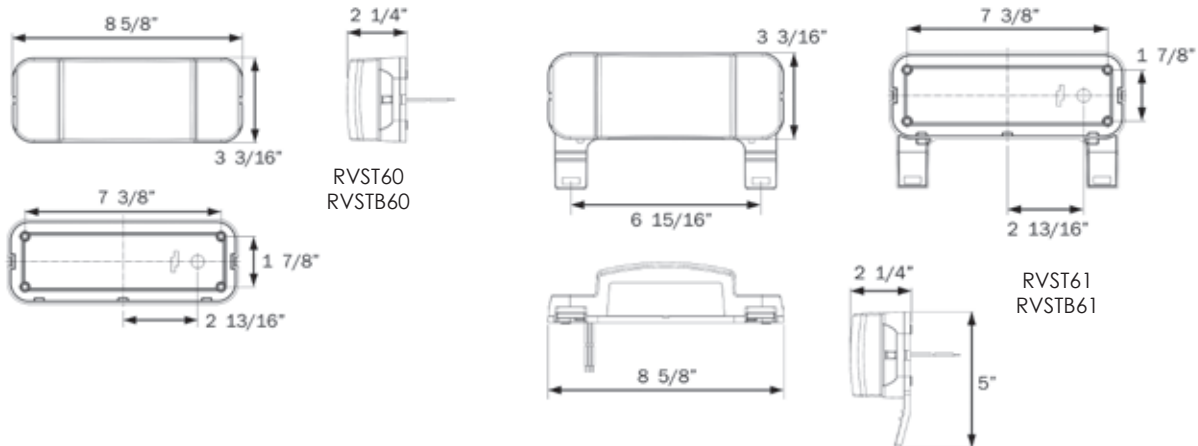

RV COMBINATION TAIL LIGHTS

## RVST50/51 SERIES RV Combination Tail Lights

- Combination stop/turn/tail light for surface mount
- Driver side lights include license plate illuminator and mounting bracket
- Snap-on lens and replaceable bulb
- Available with white or black base
- Hard wired, ground wire included

BULK P/N	POLYPACK P/N	DESCRIPTION	QTY
<b>RV COMBINATION TAIL LIGHTS</b>			
RVST50	RVST50P	Passenger side RV tail light, white base	48
RVST51	RVST51P	Driver side RV tail light, white base	48
RVSTB50	RVSTB50P	Passenger side RV tail light, black base	48
RVSTB51	RVSTB51P	Driver side RV tail light, black base	48
<b>ACCESSORIES</b>			
AST50B	AST50BP	Tail light lens, RVST50	10
AST51B	AST51BP	Tail light lens, RVST51	10
RV50BK	RV50BKP	Wedge base mounting bezel, white	100
A2057B	A2057BP	2057 replacement bulb	50
<b>RETAIL</b>			
RVST50S	Passenger side, white base, clam		6
RVST51S	Driver side, white base, clam		6

<b>FMVSS</b>	RVST50: A I S T; RVST51: A I S T L
<b>MATERIALS</b>	Acrylic lens and plastic housing
<b>VOLT/AMP</b>	12.8VDC - 2.4A Stop, 0.4A Tail
<b>WT/DIMS</b>	RVST50: .419 lb. / 8.625" x 4.625" x 2.063" RVST51: .419 lb. / 8.625" x 6.313" x 2.063"
<b>WARRANTY</b>	Three Year Warranty

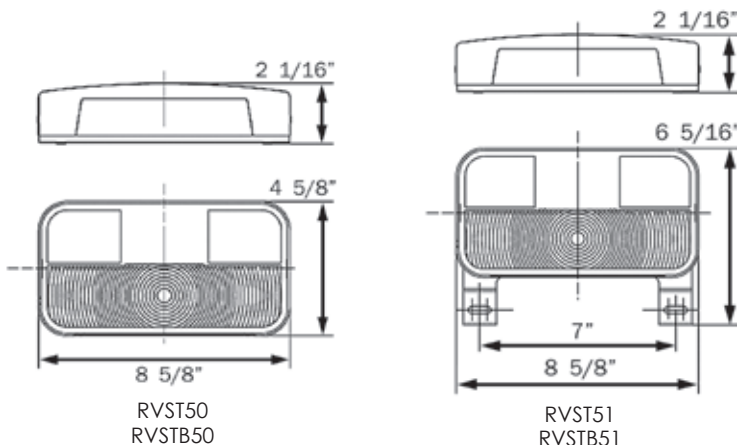

**optronics**

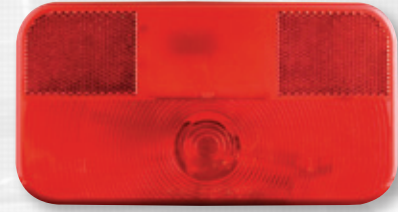

RVST50  
RVSTB50



RVST51



RVSTB51



RV50BK

RV COMBINATION  
TAIL LIGHTS



## RVST55/56 SERIES RV Combination Tail Lights with Back-Up Lights



RVST55  
RVBST55



RVST56



RVBST56



RV50BK

- Combination stop/turn/tail/back-up light for surface mount
- Driver side lights include license plate illuminator and mounting bracket
- Snap-on lens and replaceable bulbs (2057 tail/1156 back-up)
- Hard wired, ground wire included

BULK P/N	POLYPACK P/N	DESCRIPTION	QTY
<b>RV COMBINATION TAIL LIGHTS</b>			
RVST55	RVST55P	Passenger side RV tail light, white base	48
RVST56	RVST56P	Driver side RV tail light, white base	48
RVBST55	RVBST55P	Passenger side RV tail light, black base	48
RVBST56	RVBST56P	Driver side RV tail light, black base	48
<b>ACCESSORIES</b>			
RV50BK	RV50BKP	Wedge base mounting bezel, white	100
A2057B	A2057BP	2057 replacement bulb	50
<b>RETAIL</b>			
RVST55S	Passenger side, white base, clam		6
RVST56S	Driver side, white base, clam		6

**FMVSS** RVST55: A I S T; RVST56: A I S T L  
**MATERIALS** Acrylic lens and plastic housing  
**VOLT/AMP** 12.8VDC - 2.2A Stop, 0.4A Tail, 2.1A Back-Up  
**WT/DIMS** RVST55: .419 lb. / 8.625" x 4.625" x 2.063"  
 RVST56: .419 lb. / 8.625" x 6.313" x 2.063"  
**WARRANTY** Three Year Warranty

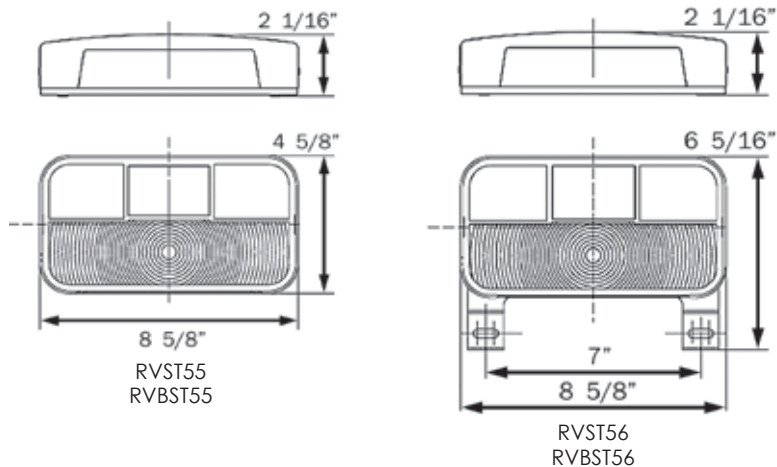

RV COMBINATION  
TAIL LIGHTS



## ILL70/71 SERIES

### Opti-Brite™ LED Awning Lights for Surface Mount

- Low profile awning mount lights with wedge base that directs light at a 45-degree angle
- Hard wired design includes both lead and ground wires
- Select from 11-inch and 18-inch models
- Available in amber and white LED
- Sealed, waterproof



ILL70CBAWN



ILL71CBAWN



ILL70ABAWN

BULK P/N	POLYPACK P/N	DESCRIPTION	QTY
<b>11" WHITE LED - 9 DIODES</b>			
ILL70CBAWN	ILL70CBAWNP	No switch, chrome housing	10
ILL70CBBAWN	ILL70CBBAWNP	No switch, black housing	10
ILL70CBSAWN	ILL70CBSAWNP	On/off switch, black housing	10
ILL70CCSAWN	ILL70CCSAWNP	On/off switch, chrome housing	10
<b>11" AMBER LED - 9 DIODES</b>			
ILL70ABAWN	ILL70ABAWNP	No switch, chrome housing	10
ILL70ABBAWN	ILL70ABBAWNP	No switch, black housing	10
<b>Raw lumen output: 189 lm</b>			
<b>Effective lumen output: 171 lm</b>			

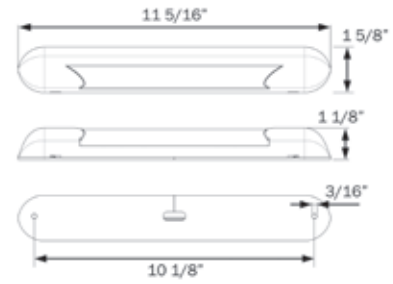

ILL70

BULK P/N	POLYPACK P/N	DESCRIPTION	QTY
<b>18" WHITE LED - 18 DIODES</b>			
ILL71CBAWN	ILL71CBAWNP	No switch, chrome housing	10
<b>Raw lumen output: 370 lm</b>			
<b>Effective lumen output: 342 lm</b>			

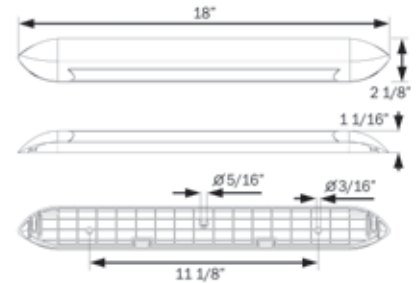

ILL71

<b>MATERIALS</b>	Polycarbonate lens and housing		
<b>VOLT/AMP</b>	ILL70:	12.8VDC - .150A	
	ILL71:	12.8VDC - .300A	
<b>WT/DIMS</b>	ILL70:	.154 lb. / 11.313" x 1.625" x 1.125"	
	ILL71:	.187 lb. / 18" x 2.125" x 1.063"	
<b>WARRANTY</b>	Lifetime LED Warranty		

**IP67 rating:** protected from dust and capable of withstanding water immersion, offering increased reliability and service life

RV PORCH/CABIN & SECURITY LIGHTS



## RVPLL8/9 SERIES Low Profile Porch/Utility Lights

- Surface mount LED porch/utility lights
- Available with yellow or clear lens
- Hard wired, includes separate ground wire



RVPLL8A



RVPLL8AB



RVPLL8C



RVPLL8CB



RVPLL9CC

BULK P/N	POLYPACK P/N	DESCRIPTION	QTY
<b>YELLOW PORCH LIGHTS</b>			
RVPLL8A	RVPLL8AP	White housing	50
RVPLL8AB	RVPLL8ABP	Black housing	50
<b>CLEAR UTILITY LIGHTS</b>			
RVPLL8C	RVPLL8CP	White housing	50
RVPLL8CB	RVPLL8CBP	Black housing	50
RVPLL9CC	RVPLL9CCP	Chrome housing	50

<b>CERTIFICATION</b>	CSA
<b>MATERIALS</b>	Acrylic lens and plastic housing
<b>VOLT/AMP</b>	12.8VDC .16A
<b>WT/DIMS</b>	.413 lbs. / 9.75" x 3.438" x 2.125"
<b>WARRANTY</b>	Lifetime LED Warranty

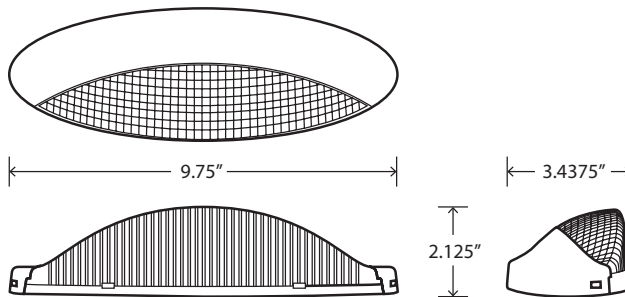

## RVPL1/3 SERIES

### Rectangular Porch/Utility Lights

- Surface mount porch/cabin lights (CSA/UL listed)
- White housing with snap-on lens and replaceable bulb (1141)
- Available with yellow or clear lens
- Hard wired with separate ground wire



RVPL1A



RVPL3A



RVPL1C



RVPL3C

BULK P/N	POLYPACK P/N	DESCRIPTION	QTY
<b>YELLOW PORCH LIGHTS</b>			
RVPL1A	RVPL1AP	Yellow porch light, no switch	50
RVPL3A	RVPL3AP	Yellow porch light with switch	50
<b>CLEAR UTILITY LIGHTS</b>			
RVPL1C	RVPL1CP	Clear utility light, no switch	50
RVPL3C	RVPL3CP	Clear utility light with switch	50
<b>ACCESSORIES</b>			
APL1AB	APL1ABP	Yellow replacement lens	10
APL1CB	APL1CBP	Clear replacement lens	10

<b>CERTIFICATION</b>	CSA / UL
<b>MATERIALS</b>	Acrylic lens and plastic housing
<b>VOLT/AMP</b>	12.8VDC - 1.4A
<b>WT/DIMS</b>	.419 lb. / 6.375" x 3.5" x 2.094"
<b>WARRANTY</b>	Three Year Warranty

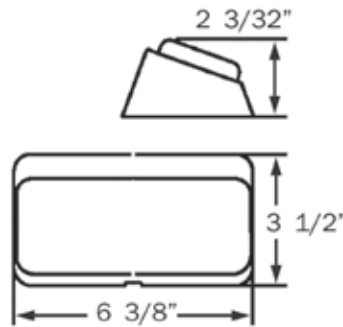

RV PORCH/CABIN  
& SECURITY LIGHTS



## RVPL5/7 SERIES Oval Porch/Utility Lights



RVPL5A



RVPL5AB



RVPL7A



RVPL7AB



RVPL5C



RVPL5CB



RVPL7C



RVPL7CB

- Surface mount porch utility lights available with or without switch
- White or black housing with snap-on lens and replaceable bulb (1141)
- Available with yellow or clear lens
- Hard wired with separate ground wire

BULK P/N	POLYPACK P/N	DESCRIPTION	QTY
<b>YELLOW PORCH LIGHTS</b>			
RVPL5A	RVPL5AP	Yellow porch light, white housing, no switch	50
RVPL5AB	RVPL5ABP	Yellow porch light, black housing, no switch	50
RVPL7A	RVPL7AP	Yellow porch light, white housing, with switch	50
RVPL7AB	RVPL7ABP	Yellow porch light, black housing, with switch	50
<b>CLEAR UTILITY LIGHTS</b>			
RVPL5C	RVPL5CP	Clear utility light, white housing, no switch	50
RVPL5CB	RVPL5CBP	Clear utility light, black housing, no switch	50
RVPL7C	RVPL7CP	Clear utility light, white housing, with switch	50
RVPL7CB	RVPL7CBP	Clear utility light, black housing, with switch	50
<b>ACCESSORIES</b>			
APL5AB	APL5ABP	Yellow replacement lens	10
APL5CB	APL5CBP	Clear replacement lens	10

<b>CERTIFICATION</b>	CSA / UL
<b>MATERIALS</b>	Acrylic lens and plastic housing
<b>VOLT/AMP</b>	12.8VDC - 1.4A
<b>WT/DIMS</b>	.265 lb. / 6.25" x 3.438" x 1.875"
<b>WARRANTY</b>	Three Year Warranty

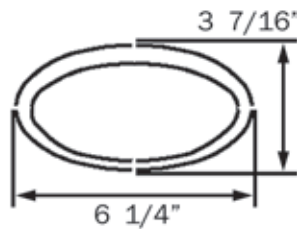
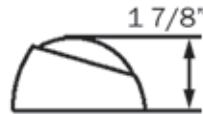

## RVPL8 SERIES

### Low Profile Porch/Utility Lights

- Surface mount porch utility lights
- Snap-on lens and replaceable bulb (12V 10W halogen)
- Available with yellow or clear lens
- Hard wired with separate ground wire

BULK P/N	POLYPACK P/N	DESCRIPTION	QTY
<b>YELLOW PORCH LIGHTS</b>			
RVPL8AB	RVPL8ABP	Yellow porch light, black housing	50
<b>CLEAR UTILITY LIGHTS</b>			
RVPL8C	RVPL8CP	Clear utility light, white housing	50
RVPL8CB	RVPL8CBP	Clear utility light, black housing	50
RVPL9CC	RVPL9CCP	Clear utility light, chrome housing	50

<b>CERTIFICATION</b>	CSA
<b>MATERIALS</b>	Acrylic lens and plastic housing
<b>VOLT/AMP</b>	12.8VDC - 0.78A
<b>WT/DIMS</b>	.265 lb. / 10" x 3.5" x 2.125"
<b>WARRANTY</b>	Three Year Warranty

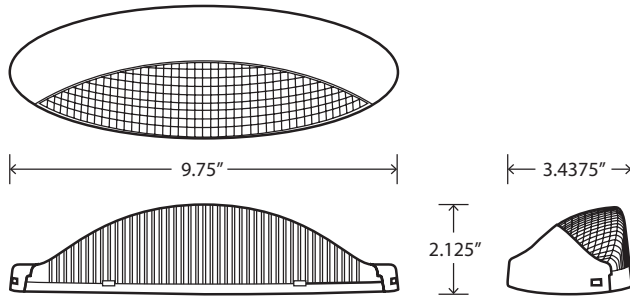

RVPL8AB



RVPL8C



RVPL8CB



RVPL9CC

RV PORCH/CABIN  
& SECURITY LIGHTS



## RVSL21/31 SERIES Scare Lights



RVSL21

- Surface mount security lights with mounting gasket (CSA)
- Stainless steel or white housing with screw-on lens and replaceable bulb (1156)
- Hard wired with separate ground wire

BULK P/N	POLYPACK P/N	DESCRIPTION	QTY
<b>CLEAR SECURITY LIGHTS</b>			
RVSL21	RVSL21P	Scare light, stainless housing	25
RVSL31	RVSL31P	Scare light, white housing	25



RVSL31

<b>CERTIFICATION</b>	CSA
<b>MATERIALS</b>	Acrylic lens, metal housing
<b>VOLT/AMP</b>	12.8VDC - 1.4A
<b>WT/DIMS</b>	0.97 lb. / 8.656" x 8.656" x 1.969"
<b>WARRANTY</b>	Three Year Warranty

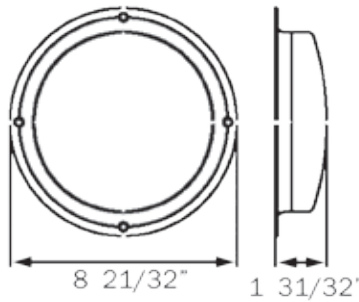

## RVILL39 LED Surface Mount Interior Ceiling Light



- Surface mount ceiling light with switch
- Effective lumen output 230 lm
- Replaceable white snap-on bezel
- Dual power: use with 12VDC and 24VDC systems
- 18-gauge, 6-inch lead and ground wire



RVILL39

BULK P/N	POLYPACK P/N	DESCRIPTION	QTY
<b>INTERIOR CEILING LIGHTS - 9 DIODES</b>			
RVILL39	RVILL39P	Interior light with switch	10

**Raw lumen output:** 280 lm  
**Effective lumen output:** 230 lm

<b>MATERIALS</b>	Clear PMMA lens, ABS bezel
<b>VOLT/AMP</b>	12.8VDC - 0.25A
<b>WT/DIMS</b>	.325 lb. / 7.188" x 5.188" x 1.438"
<b>WARRANTY</b>	Lifetime LED Warranty

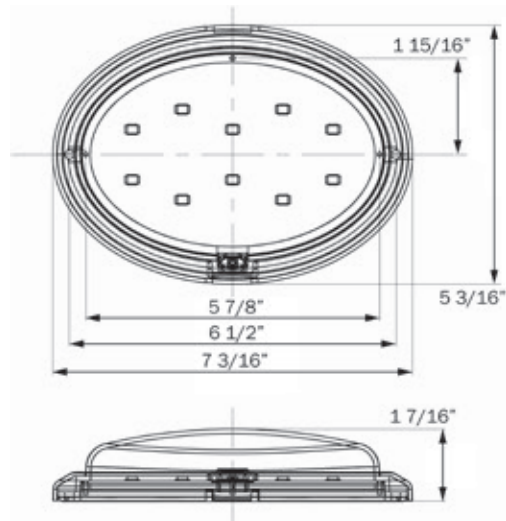



## RVILL33/34 SERIES LED Interior RV Lights

- Surface mount interior lights with switch (CSA)
- Single or double lights with snap-on lens
- LED technology – uses 90% less energy
- Hard wired with separate ground wire



RVILL33



RVILL34

BULK P/N	POLYPACK P/N	DESCRIPTION	QTY
<b>LED INTERIOR LIGHTS</b>			
RVILL33	RVILL33P	Single, on/off switch, 9 diodes	50
RVILL34	RVILL34P	Double, on/off switch, 18 diodes	25
<b>ACCESSORIES</b>			
AIL32B	AIL32BP	Clear replacement lens for RVIF31/32	10

**RVILL33 lumen output (raw/effective):** 460 lm / 407 lm

**RVILL34 lumen output (raw/effective):** 920 lm / 815 lm

<b>CERTIFICATION</b>	CSA
<b>MATERIALS</b>	Polycarbonate lens and plastic housing
<b>VOLT/AMP</b>	RVILL33: 12.8VDC - 0.3A RVILL34: 12.8VDC - 0.6A
<b>WT/DIMS</b>	RVILL33: .794 lb. / 6.377" x 4.173" x 1.787" RVILL34: 1.587 lb. / 10.283" x 4.173" x 1.787"
<b>WARRANTY</b>	Lifetime LED Warranty

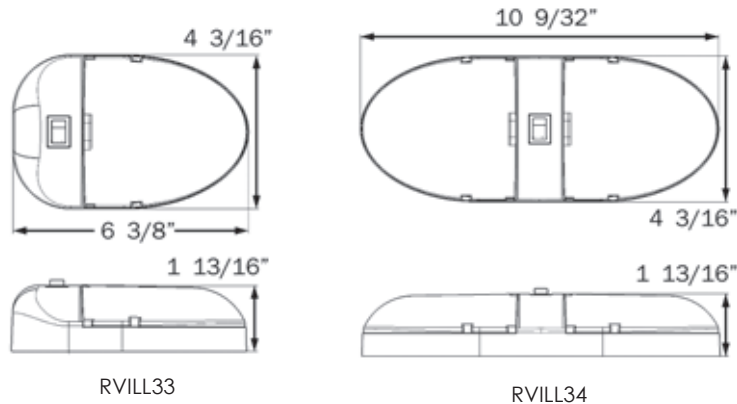



## RVIL35/36 SERIES

### Interior RV Lights



- Surface mount interior lights with switch (CSA)
- Single or double lights with snap-on lens and replaceable bulb
- Hard wired with separate ground wire



RVIL35



RVIL36

BULK P/N	POLYPACK P/N	DESCRIPTION	QTY
<b>INTERIOR RV LIGHTS</b>			
RVIL35	RVIL35P	Single, on/off switch	50
RVIL36	RVIL36P	Double, on/off switch	25
<b>ACCESSORIES</b>			
ARVIL35B	ARVIL35BP	Replacement lens	10
A921B	-	921 replacement bulb	50

<b>CERTIFICATION</b>	CSA
<b>MATERIALS</b>	Polycarbonate lens and plastic housing
<b>VOLT/AMP</b>	RVIL35: 12.8VDC - 1.3A RVIL36: 12.8VDC - 2.6A
<b>WT/DIMS</b>	RVIL35: .794 lb. / 6.375" x 4.125" x 1.75" RVIL36: 1.587 lb. / 10.25" x 4.125" x 1.75"
<b>WARRANTY</b>	Three Year Warranty

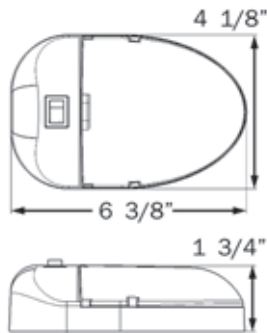

RVIL35

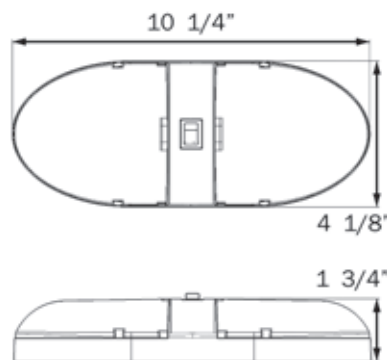

RVIL36



## RVIL21/22 SERIES RV Interior Lights

- Surface mount ceiling lights with switch (CSA)
- Single or double lights with snap-on lens and replaceable bulb
- Hard wired with separate ground wire



RVIL21



RVIL22

BULK P/N	POLYPACK P/N	DESCRIPTION	QTY
<b>RV INTERIOR LIGHTS</b>			
RVIL21	RVIL21P	Single, on/off switch	50
RVIL22	RVIL22P	Double, on/off switch	25
<b>ACCESSORIES</b>			
AIL21B	AIL21BP	Clear replacement lens	10
A921B	-	921 replacement bulb	50
<b>RETAIL</b>			
RVIL21S	Single, on/off switch, clam		6
RVIL22S	Double, on/off switch, clam		6

<b>CERTIFICATION</b>	CSA / UL
<b>MATERIALS</b>	Acrylic lens and plastic housing
<b>VOLT/AMP</b>	RVIL21: 12.8VDC - 0.5A RVIL22: 12.8VDC - 1.4A
<b>WT/DIMS</b>	RVIL21: .794 lb. / 7.078" x 4.25" x 1.969" RVIL22: 1.587 lb. / 12" x 4.25" x 1.844"
<b>WARRANTY</b>	Three Year Warranty

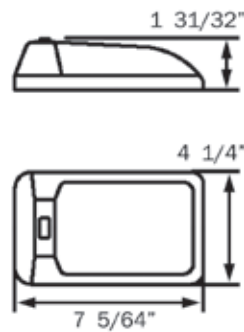

RVIL21

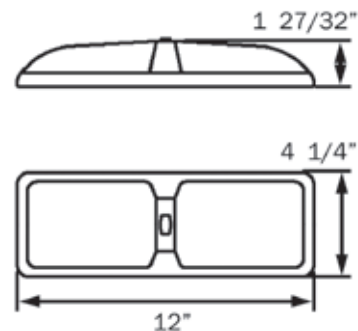

RVIL22

## RVFL51 SERIES Portable Interior Light



- Mount with clamp for portability
- Includes coil cord with male plug
- Combination reading light and fan with switch for each; replaceable bulb (912)



RVFL51

BULK P/N	POLYPACK P/N	DESCRIPTION	QTY
<b>PORTABLE LIGHT</b>			
RVFL51	RVFL51P	Reading light with fan, coil cord, male plug	24
<b>ACCESSORIES</b>			
RVC100	RVC100P	Bunk light adaptor with jack (CSA)	100
A921B	-	921 replacement bulb for RVIM46	50

<b>CERTIFICATION</b>	CSA
<b>MATERIALS</b>	Polycarbonate lens and plastic housing
<b>VOLT/AMP</b>	12.8VDC - 1.3A (fan and light)
<b>WT/DIMS</b>	RVFL51: 1.587 lb. / 8.5" x 5.625" x 2.875" RVC100: .6 lb. / 2.484" x 2.484" x 1.438"
<b>WARRANTY</b>	Three Year Warranty



RVC100



## COMPACT COURTESY LIGHTS

- Choose from surface mount and flush mount lights
- Hard wired, include lead and ground



16802B



19102B

BULK P/N	POLYPACK P/N	DESCRIPTION	QTY
<b>COURTESY LIGHTS</b>			
16802B	16802P	Black hooded light (bulb 194; .24A)	100
19102B	19102P	Flush mount light (bulb 194; .24A)	50

<b>CERTIFICATION</b>	CSA
<b>MATERIALS</b>	Plastic
<b>VOLT</b>	12.8VDC
<b>WT/DIMS</b>	16802B: .2 lb. / 2.75" x 1.75" x 1.5" 19102B: .2 lb. / 4.5" x 1.25"
<b>WARRANTY</b>	Three Year Warranty



## CHROME COURTESY LIGHTS

- Hooded lights with chrome finish, white lens
- Hard wired, include lead and ground



068NME



068WMTE

BULK P/N	POLYPACK P/N	DESCRIPTION	QTY
<b>COURTESY LIGHTS</b>			
068NME	068NMEP	Snap-in light	50
068WMTE	068WMTEP	Light with stainless steel mounting plate	50

<b>CERTIFICATION</b>	UL
<b>MATERIALS</b>	Metal (068WMTE - stainless steel plate), polycarbonate lens
<b>VOLT/AMP</b>	12.8VDC - 0.59A (bulb 67, 12V 4CP)
<b>WT/DIMS</b>	068NME: .2 lb. / 1.5" x 1.5" x 2" 068WMTE: .2 lb. / 2.75" x 1.625" x 2"
<b>WARRANTY</b>	Three Year Warranty

## WATERPROOF COURTESY LIGHT



- Submersible design with gaskets
- Hard wired, includes lead and ground

BULK P/N	POLYPACK P/N	DESCRIPTION	QTY
<b>COURTESY LIGHT</b>			
24074B	24074P	Rear mount light with nut	50



24074B

<b>CERTIFICATION</b>	CSA
<b>MATERIALS</b>	Plastic
<b>VOLT/AMP</b>	12.8VDC - 1.25A (bulb 194)
<b>WT/DIMS</b>	.2 lb. / 2" x 2" x 1.75"
<b>WARRANTY</b>	Three Year Warranty

## OVAL COURTESY LIGHTS



- Semi-recessed with clear lens
- Hard wired, includes lead and ground

BULK P/N	POLYPACK P/N	DESCRIPTION	QTY
<b>COURTESY LIGHTS</b>			
2407764B	2407764P	White finish	100
2407765B	2407765P	Dream white finish	50
2407771C	2407771CP	Black finish, chrome reflector	50



TOP TO BOTTOM:  
2407764B  
2407765B  
2407768B  
2407771C

<b>CERTIFICATION</b>	CSA
<b>MATERIALS</b>	Plastic
<b>VOLT/AMP</b>	12.8VDC - .17A (bulb 161, wedge base)
<b>WT/DIMS</b>	.2 lb. / 4" x 2.625" x 1.25"
<b>WARRANTY</b>	Three Year Warranty

RV COURTESY LIGHTS



## AURORA SERIES Bullet Light



04010040B

- Metal directional light with adjustable bracket and switch
- Surface mount with no exposed fasteners
- Hard wired, include lead and ground
- Bulb 922 wedge base incandescent

BULK P/N	POLYPACK P/N	DESCRIPTION	QTY
<b>BULLET LIGHTS</b>			
04010040B	04010040P	Brushed nickel, black switch	30

CERTIFICATION	CSA
MATERIALS	Metal housing
VOLT/AMP	12.8VDC - 0.98A (bulb 922 wedge base)
WT/DIMS	.5 lb. / 2.75" x 3.75" x 4.625"
WARRANTY	Three Year Warranty



## CO-PILOT LIGHTS Halogen and Incandescent



03001175B

- Map lights for sidewalls, drink trays and dashboards
- Switch is incorporated into light design
- Flexible 18" arm

BULK P/N	POLYPACK P/N	DESCRIPTION	QTY
<b>CO-PILOT LIGHTS</b>			
03001175B	03001175P	Halogen (5W bulb/0.35A)	10
03001150B	03001150P	Incandescent (1816 bulb/0.27A)	10

CERTIFICATION	UL
MATERIALS	Metal, black finish
VOLT	12.8VDC
WT/DIMS	.6 lb. / 18"
WARRANTY	Three Year Warranty

## GALAXY LED SERIES

### LED Directional Lights

- Recess mount lights with swivel globes and switches
- Removable snap-on trim ring, sold separately
- Hard wired, includes lead and ground

BULK P/N	POLYPACK P/N	DESCRIPTION	QTY
<b>LED DIRECTIONAL LIGHTS</b>			
240047171LB	-	LED Single fixture	50
240147171LB	-	LED Double fixture	20
24004TR71	24004TR71P	Trim ring for single fixture, black	50
24014TR71	24014TR71P	Trim ring for double fixture, black	50

<b>CERTIFICATION</b>	CSA
<b>MATERIALS</b>	Plastic
<b>VOLT/AMP</b>	Single: 12.8VDC - 0.020A Double: 12.8VDC - 0.054A
<b>WT/DIMS</b>	Single: .15 lb. / 3.5" x 4.875" x 1.75" Double: .31 lb. / 3.5" x 9.625" x 1.75"
<b>WARRANTY</b>	Lifetime LED Warranty



240047171LB & 24004TR71



240147171LB & 24014TR71

## GALAXY SERIES

### Directional Lights

- Recess mount lights with swivel globes and switches
- Removable snap-on trim ring, sold separately
- Hard wired, includes lead and ground

BULK P/N	POLYPACK P/N	DESCRIPTION	QTY
<b>DIRECTIONAL LIGHTS</b>			
240047171B	240047171P	Single fixture	50
240147171B	240147171P	Double fixture	20
24004002B	-	Single fixture with reflector & 5W bulb	50
06001022B	06001022P	Single fixture with reflector	50
24004TR71	24004TR71P	Trim ring for single fixture, black	50
24014TR71	24014TR71P	Trim ring for double fixture, black	50

<b>CERTIFICATION</b>	CSA
<b>MATERIALS</b>	Plastic
<b>VOLT/AMP</b>	Single: 12.8VDC - 0.35A (bulb 168 wedge base) Double: 12.8VDC - 0.70A (bulb 168 wedge base)
<b>WT/DIMS</b>	Single: .24 lb. / 3.5" x 4.875" x 1.75" Double: .47 lb. / 3.5" x 9.625" x 1.75"
<b>WARRANTY</b>	Three Year Warranty



240047171B & 24004TR71



240147171B & 24014TR71

RV DIRECTIONAL LIGHTS



825LED & 825TR02



826LED & 826TR02

## UNITEK LED SERIES LED Directional Lights

- Recess mount LED fixtures with multi-locking pivoting globes that activate lights
- Removable snap-on trim ring, sold separately
- Three-terminal hook-up for dome light application

BULK P/N	POLYPACK P/N	DESCRIPTION	QTY
LED DIRECTIONAL LIGHTS			
825LED	-	Single fixture, 9 diodes, black	50
826LED	826LEDP	Double fixture, 18 diodes, black	50
825TR02	825TR02P	Single trim ring, black	50
826TR02	826TR02P	Double trim ring, black	25
826TR12	816TR12P	Double trim ring, light gray	25
826TR90	-	Double trim ring, platinum silver	25

<b>CERTIFICATION</b>	UL
<b>MATERIALS</b>	Plastic
<b>VOLT/AMP</b>	12.8VDC - Single 0.35A , Double 0.70A
<b>WT/DIMS</b>	Single: .25 lb. / 4.125" x 3.5" x 1.5" Double: .48 lb. / 7" x 3.875" x 1.375"
<b>WARRANTY</b>	Lifetime LED Warranty



826L & 826TR02

## UNITEK SERIES Directional Light

- Recess mount fixture with multi-locking pivoting globes that activate lights
- Removable lenses allow easy bulb replacement
- Removable snap-on trim ring, sold separately
- Three-terminal hook-up for dome light application

BULK P/N	POLYPACK P/N	DESCRIPTION	QTY
DIRECTIONAL LIGHT			
826L	826LP	Double fixture, black	50
See complete listing of trim rings above			

<b>CERTIFICATION</b>	UL
<b>MATERIALS</b>	Plastic
<b>VOLT/AMP</b>	12.8VDC - 0.70A (bulb 168 wedge base)
<b>WT/DIMS</b>	.48 lb. / 7" x 3.875" x 1.375"
<b>WARRANTY</b>	Three Year Warranty



## ULTRATEK SERIES Directional Lights

- Flush mount fixtures with pivoting globes that activate lights
- Removable snap-on trim ring, sold separately
- Removable lens for easy bulb replacement
- Three-terminal hook-up for dome light application

BULK P/N	POLYPACK P/N	DESCRIPTION	QTY
<b>DIRECTIONAL LIGHTS</b>			
06001013B	06001013P	Single fixture, black	120
06001014B	06001014P	Double fixture, black	120
3802071BZL	3802071BZLP	Single trim ring, black	30
3801071BZL	3801071BZLP	Double trim ring, black	30

<b>CERTIFICATION</b>	CSA / NRTL/C / ANSI/UL
<b>MATERIALS</b>	Plastic
<b>VOLT/AMP</b>	Single: 12.8VDC - 0.37A (bulb 590 xenon 4cp) Double: 12.8VDC - 0.74A (bulb 590 xenon 4cp)
<b>WT/DIMS</b>	Single: .27 lb. / 3.75" x 3.5" x 1.5" Double: .40 lb. / 5.875" x 3.5" x 1.5"
<b>WARRANTY</b>	Three Year Warranty

**optronics**



06001013B & 3802071BZL



06001014B & 3801071BZL

## AUTOTEK SERIES Directional Lights

- Low profile aircraft-style lights with switch
- Removable grids allow easy bulb replacement
- Snap-on trim ring covers mounting screws
- Three-terminal hook-up for dome light application

BULK P/N	POLYPACK P/N	DESCRIPTION	QTY
<b>DIRECTIONAL LIGHTS</b>			
725022B	725022P	Single fixture, black	25
726022B	726022P	Double fixture, black	20

<b>CERTIFICATION</b>	CSA / UL
<b>MATERIALS</b>	Plastic
<b>VOLT/AMP</b>	Single: 12.8VDC - 0.69A (bulb 906 T5 wedge base) Double: 12.8VDC - 1.38A (bulb 906 T5 wedge base)
<b>WT/DIMS</b>	Single: .32 lb. / 4.625" x 3.5" x 2.25" Double: .52 lb. / 7.625" x 3.5" x 2.25"
<b>WARRANTY</b>	Three Year Warranty

**optronics**



725022B



726022B

RV DIRECTIONAL LIGHTS



## EUROPA SERIES Directional Lights



06001072B



06001026B  
06001015B  
06001061B

- Choose from single recess mount and single/double surface mount series with on/off switches
- Prismatic reflector globes for bright directional beams
- Easy bulb replacement (168 wedge base)

BULK P/N	POLYPACK P/N	DESCRIPTION	QTY
<b>RECESS MOUNT</b>			

06001072B	06001072P	Single fixture, black	20
-----------	-----------	-----------------------	----

<b>SURFACE MOUNT</b>			
06001026B	06001026P	Single fixture, black	20
06001015B	06001015P	Double fixture, black	20
06001061B	06001061P	Double fixture plus dome light, black	20

<b>CERTIFICATION</b>	UL / CSA		
<b>MATERIALS</b>	Plastic		
<b>VOLT/AMP</b>	Single:	12.8VDC - 0.35A (bulb 168 wedge base)	
	Double:	12.8VDC - 0.70A (bulb 168 wedge base)	
<b>WT/DIMS</b>	06001072B/P:	.18 lb. / 4.5" x 3.75" x 1.75"	
	06001026B/P:	.16 lb. / 4.125" x 2.937" x 1.625"	
	06001015B/P:	.28 lb. / 2.75" x 6.25" x 1.75"	
	06001061B/P:	.46 lb. / 8.375" x 2.75" x 1.75"	
<b>WARRANTY</b>	Three Year Warranty		

RV DIRECTIONAL LIGHTS



## EUROPA SERIES Ultrabright Directional Lights



06001048B



06001037B

- High output for bright, directional reading light
- Easy bulb replacement (1003 bayonet base)
- Separate switches for each bulb

BULK P/N	POLYPACK P/N	DESCRIPTION	QTY
<b>ULTRA BRIGHT SURFACE MOUNT</b>			

06001048B	06001048P	Single fixture, black	20
-----------	-----------	-----------------------	----

06001037B	06001037P	Double fixture, black	20
-----------	-----------	-----------------------	----

<b>CERTIFICATION</b>	UL		
<b>MATERIALS</b>	Plastic		
<b>VOLT/AMP</b>	Single:	12.8VDC - 0.94A (bulb 1003 bayonet base)	
	Double:	12.8VDC - 0.94A (bulb 1003 bayonet base)	
<b>WT/DIMS</b>	Single:	.25 lb. / 4" x 2.875" x 2.5"	
	Double:	.47 lb. / 6.125" x 2.75" x 2.625"	
<b>WARRANTY</b>	Three Year Warranty		

## ODYSSEY SERIES Directional Light

- Recess mount light with press on/off feature at lens
- Removable snap-on trim ring, sold separately
- Hard wired, includes lead and ground



0601B & 060102B

BULK P/N	POLYPACK P/N	DESCRIPTION	QTY
<b>DIRECTIONAL LIGHTS</b>			
0601B	0601P	Light, black	200
060102B	060102P	Trim ring, black	50

<b>CERTIFICATION</b>	CSA / NRTL/C / ANSI/UL
<b>MATERIALS</b>	Plastic
<b>VOLT</b>	12.8VDC - 0.94A (bulb 906 T5 wedge base)
<b>WT/DIMS</b>	.26 lb. / 3.125" x 5" x 2"
<b>WARRANTY</b>	Three Year Warranty

## STARGAZER SERIES Directional Lights

- Recess mount fixtures with multi-locking, pivoting globes that activate lights
- Removable snap-on trim ring, sold separately
- Removable lens for easy bulb replacement
- Three-terminal hook-up for dome light application



06001001B & 06300004B

BULK P/N	POLYPACK P/N	DESCRIPTION	QTY
<b>DIRECTIONAL LIGHTS</b>			
06001001B	06001001P	Single fixture, black	50
06002001B	06002001P	Double fixture, black	48
06300004B	06300004P	Single trim ring, black	50
06300003B	06300003P	Double trim ring, black	25

<b>CERTIFICATION</b>	CSA / NRTL/C / ANSI/UL
<b>MATERIALS</b>	Plastic
<b>VOLT/AMP</b>	Single: 12.8VDC - 0.35A (bulb 168 wedge base) Double: 12.8VDC - 0.70A (bulb 168 wedge base)
<b>WT/DIMS</b>	Single: .25 lb. / 3.375" x 4" x 1.5" Double: .44 lb. / 7" x 3.875" x 1.5"
<b>WARRANTY</b>	Three Year Warranty



06002001B & 06300003B



## CENTURA SERIES



105500SP

105520B

- Simple design with aluminum base, acrylic lens and single or dual switch
- Slim design: only 2.5" wide and 1.13" thick
- Available in 5.5" and 12.5" lengths

BULK P/N	POLYPACK P/N	DESCRIPTION	QTY
<b>SURFACE MOUNT</b>			
105500SP	-	Single bulb, 5.5"	50
105520B	105520BP	Triple bulb, 12.5"	25
<b>MATERIALS</b>	Aluminum base, acrylic lens		
<b>VOLT/AMP</b>	5.5": 12.8VDC - 0.97A (bulb 211) 12.5": 12.8VDC - 2.91A (bulb 211-2)		
<b>WT/DIMS</b>	5.5": .20 lb. / 5.75" x 2.5" x 1.25" 12.5": .44 lb. / 12.75" x 2.5" x 1.25"		
<b>WARRANTY</b>	Three Year Warranty		



## SLIMLINE SERIES



18543910B

18543916B

18543936B

- Contemporary design with single or dual switch
- Low profile: 4" wide and only 1.5" thick
- Available in three lengths

BULK P/N	POLYPACK P/N	DESCRIPTION	QTY
<b>SURFACE MOUNT</b>			
18543910B	-	Single bulb, 4", no switch, white	25
18543916B	18543916BP	Single bulb, 5.5", switch, white	100
18543936B	-	Two bulb, 7.5", dual switch, white	20
<b>MATERIALS</b>	Plastic		
<b>VOLT/AMP</b>	Single: 12.8VDC - 1.0A (bulb 912) Dual: 12.8VDC - 2.0A (bulb 912)		
<b>WT/DIMS</b>	4": .4 lb. / 4" x 4" x 1.5" 5.5": .6 lb. / 5.5" x 4" x 1.5" 7": .8 lb. / 7" x 4" x 1.5"		
<b>WARRANTY</b>	Three Year Warranty		

## 24113160B DOME LIGHT

- Halogen dome light with switch for general illumination
- Designed for overhead or bulkhead surface mount
- White plastic construction with frosted lens



24113160B

BULK P/N	POLYPACK P/N	DESCRIPTION	QTY
<b>DOMELIGHT</b>			
24113160B	24113160P	5.75" white dome light	30

<b>CERTIFICATION</b>	NRTL/C
<b>MATERIALS</b>	Plastic
<b>VOLT/AMP</b>	12.8VDC - 0.78A (bulb G4 bi-pin)
<b>WT/DIMS</b>	.4 lb. / 5.75" x 5.75" x 1.5"
<b>WARRANTY</b>	Three Year Warranty

## 357B DOME LIGHT

- 8.5" semi-recess mount light with one halogen and one incandescent bulb
- Chrome plated housing, Lexan lens, replaceable bulbs



357B

BULK P/N	POLYPACK P/N	DESCRIPTION	QTY
<b>DOMELIGHT</b>			
357B	357P	Dome light, chrome-plated	40

<b>MATERIALS</b>	Metal housing, Lexan lens
<b>VOLT/AMP</b>	12.8VDC - 2.79A (GH9 37.5W), 0.68A (906 T5 wedge)
<b>WT/DIMS</b>	1.25 lbs. / 8.75" x 8.75" x 1.875"
<b>WARRANTY</b>	Three Year Warranty



## 69000201B DOME LIGHT

- 6-3/8" surface mount light with gray base
- Two-wire, replaceable 1142 bulb



69000201B

BULK P/N	POLYPACK P/N	DESCRIPTION	QTY
<b>DOMELIGHT</b>			
69000201B	69000201P	Dome light, gray base	40
<b>VOLT/AMP</b>	12.8VDC - 1.44A (bulb 1142)		
<b>WT/DIMS</b>	.75 lb. / 6.25" x 6.25" x 2"		
<b>WARRANTY</b>	Three Year Warranty		



## 69000300B DOME LIGHT

- 5-3/4" surface mount light with red and white bulbs
- Dual switch, frosted lens, white housing



69000300B

BULK P/N	POLYPACK P/N	DESCRIPTION	QTY
<b>DOMELIGHT</b>			
69000300B	69000300P	Dome light, red/white bulbs	20
<b>VOLT/AMP</b>	12.8VDC - 1.00A (bulb 912)		
<b>WT/DIMS</b>	.48 lb. / 5.75" x 5.75" x 1.5"		
<b>WARRANTY</b>	Three Year Warranty		



## 193 SERIES DOME LIGHTS

- Semi-recessed design with domed clear lens
- Replaceable bulb (1003 bayonet)



193BSP



193G

BULK P/N	POLYPACK P/N	DESCRIPTION	QTY
<b>DOMELIGHT</b>			
193BSP	193BSPP	Dome light, black	10
193G	193P	Dome light, gray	10

<b>MATERIALS</b>	Steel housing, polycarbonate lens		
<b>VOLT/AMP</b>	12.8VDC - 0.94A (bulb 1003 bayonet)		
<b>WT/DIMS</b>	.25 lb. / 5.75" x 2.688" x 1.5"		
<b>WARRANTY</b>	Three Year Warranty		

## DOOR PULLS & SPRING LOADED HANDLES

- 11" door pulls with hinged end caps for easy installation
- Include steel reinforced mounting bases
- Spring loaded handle, may also be used as a clothes hanger; choose from three colors

BULK P/N	POLYPACK P/N	DESCRIPTION	QTY
<b>DOOR PULLS</b>			
01180071B	01180071P	Black	25
01180089B	01180089P	Fawn	25
01180090B	01180090BP	Platinum silver	25
<b>SPRING LOADED HANDLES</b>			
2500128B	2500128P	GM pewter	50
2500171B	2500171P	Black	50
2500189B	2500189P	Fawn	50

<b>MATERIALS</b>	Pulls: ABS, Handles: Steel base, ABS handle
<b>WT/DIMS</b>	Pulls: .31 lb. / 8.75" x 1.125" x 3" Handles: .18 lb. / 11" x 1.75" x 1"
<b>WARRANTY</b>	Three Year Warranty



01180071B  
01180089B  
01180090B



2500128B  
2500171B  
2500189B

## WALL PLATES

BULK P/N	POLYPACK P/N	DESCRIPTION	QTY
<b>WALL PLATES / ACCESSORIES</b>			
13000018B	13000018P	Standard 12V outlet, plastic	200
014BCRCW	014BCRCWP	Chrome 12V receptacle with cap	100
7850NFRC	7850NFRCP	Chrome 12V receptacle with cap & wires	250
RC	RCP	Rubber cap for 12V outlet	500



13000018B



## ASH TRAYS



BULK P/N	POLYPACK P/N	DESCRIPTION	QTY
<b>ASH TRAYS</b>			
510001B	510001P	Drop-in ashtray	50
530002B	530002P	Round drop-in ashtray	40
500302B	500302P	Black lighter	25



## BEVERAGE HOLDERS



09017101B

- Versatile beverage holder for cups, cans and mugs
- Two-tier design includes a handle recess for cups and mugs, and rubber flaps to secure cans and smaller cups
- Black finish on all



3202B

1502B

302B

BULK P/N	POLYPACK P/N	DESCRIPTION	QTY
<b>CUP HOLDERS</b>			
09017101B	09017101P	Dual purpose drop-in, handle cavity	50
3202B	3202P	3" two-tier drop-in	50
302B	302P	3" single tier drop-in	50
1502B	1502P	1.5" single tier drop-in	50
15202B	15202P	1.5" two-tier drop-in	50
2409171B	2409171BP	Adjustable, fold-down	100

## REPLACEMENT BULBS RV LIGHTING

BULK P/N	POLYPACK P/N	DESCRIPTION	QTY
<b>BULBS</b>			
30000000B	-	12" fluorescent, cool white	1
30031010B	-	18" fluorescent, cool white, Philips	24
30655010B	-	10W halogen	1



# VEHICLE CONSPICUITY TAPE

- Alternating red/white pattern available in 11" red/7" white and 6" red/6" white patterns
- Solid white tape also available
- All tape is 2" wide, supplied in 150-ft rolls
- Choose from V92, V82 and V42 series tape
- Marked "DOT-C2" per NHTSA 9CFR571.108

**Reflexite®**

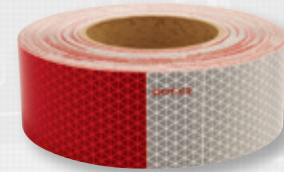

RTR150711B



RT150WBD

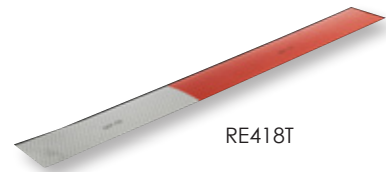

RE418T



RTR10150711CB



RTR10150WB



RTR03150711CB

BULK P/N	POLYPACK P/N	DESCRIPTION	QTY
<b>V92 CONSPICUITY TAPE - 5 YEAR</b>			
RTR15066B	RTR15066BP	6" red/6" white, continuous	1
RTR15066PB	RTR15066PBP	6" red/6" white, perforated	1
RTR150711B	RTR150711BP	11" red/7" white, continuous	1
RTR150711PB	RTR150711PBP	11" red/7" white, perforated	1
RT150W12B	RT150W12BP	Solid white, 12" sections on roll	1
RT150WBD	RT150WBDP	Solid white, continuous	1

**RETAIL**

RE418T		4-strip kit, 11" red/7" white	12
RE18T		8-strip kit, 11" red/7" white	12
RE10018T		10-strip kit, 11" red/7" white	1
RE2018T		20-strip kit, 11" red/7" white	5
RE21T		21-ft roll, 11" red/7" white	12

BULK P/N	POLYPACK P/N	DESCRIPTION	QTY
<b>V82 CONSPICUITY TAPE - 10 YEAR</b>			
RTR1015066CB	-	6" red/6" white, continuous	1
RTR10150711CB	-	11" red/7" white, continuous	1
RTR10150WB	-	Solid white, continuous	1

BULK P/N	POLYPACK P/N	DESCRIPTION	QTY
<b>V42 CONSPICUITY TAPE - 3 YEAR</b>			
RTR03150711CB	-	11" red/7" white, continuous	1

<b>FMVSS</b>	DOT-C2		
<b>WARRANTY</b>	V92:	Five Year Warranty	
	V82:	Ten Year Warranty	
	V42:	Three Year Warranty	

CONSPICUITY TAPE

# Reflexite®

## SCHOOL BUS CONSPICUITY TAPE



RT150Y2DB



RT150Y1DB



RT150Y2B



RT150Y1B

- Yellow tape available in 1" and 2" widths
- All tape is supplied in 150-ft rolls
- Choose from V92 and V82 series tape
- Meets ASTM D4956-05 (Type V), FMVSS 131 & 217, CSA D250 requirements

BULK P/N	POLYPACK P/N	DESCRIPTION	QTY
<b>V92 CONSPICUITY TAPE - 5 YEAR</b>			
RT150Y1DB	RT150Y1DBP	1" yellow, diamond pattern	1
RT150Y2DB	RT150Y2DBP	2" yellow, diamond pattern	1

BULK P/N	POLYPACK P/N	DESCRIPTION	QTY
<b>V82 CONSPICUITY TAPE - 10 YEAR</b>			
RT150Y1B	RT150Y1BP	1" yellow	1
RT150Y2B	RT150Y2BP	2" yellow	1

<b>FMVSS</b>	ASTM D4956-05 (Type V), FMVSS 131 & 217, CSA D250		
<b>WARRANTY</b>	V92:	Five Year Warranty	
	V82:	Ten Year Warranty	

# Reflexite®

## VEHICLE CONSPICUITY TAPE



RTRE150GB

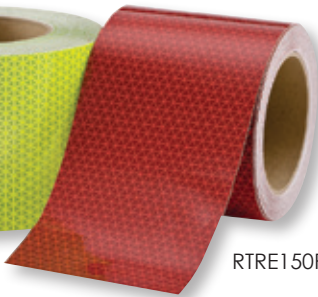

RTRE150RB

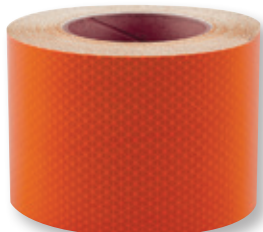

RTRE150OB

- Conformable sheeting for emergency vehicles
- Supplied in 6" wide, 150-ft rolls
- Choose from fluorescent lime, red and orange (other colors available upon request)
- Use red/lime sheeting to meet fire apparatus regulation NFPA 1901

BULK P/N	POLYPACK P/N	DESCRIPTION	QTY
<b>V98 CONFORMABLE SHEETING</b>			
RTRE150RB	RTRE150RBP	6" red, diamond pattern	1
RTRE150GB	RTRE150GBP	6" lime, diamond pattern	1
RTRE150OB	RTRE150OBP	6" orange, diamond pattern	1

<b>FMVSS</b>	NFPA 1901		
<b>WARRANTY</b>	Red/Orange:	Five Year Warranty	
	Lime:	Three Year Warranty	

CONSPICUITY TAPE

# RECTANGULAR REFLECTORS

- Select from multiple shapes, sizes and mounting methods; available in bulk, polypack and retail clams
- Acrylic construction; meet FMVSS "A" for reflex when properly applied

BULK P/N	POLYPACK P/N	DESCRIPTION	QTY
<b>REFLECTORS</b>			
RE10AB	RE10ABP	Rectangular, yellow, self adhesive	100
RE10RB	RE10RBP	Rectangular, red, self adhesive	100
RE11AB	RE11ABP	Oblong, yellow, self adhesive/screw mount	100
RE11RB	RE11RBP	Oblong, red, self adhesive/screw mount	100
RE15AB	RE15ABP	Thinline, yellow, adhesive/screw mount	100
RE15RB	RE15RBP	Thinline, red, adhesive/screw mount	100
<b>RETAIL - CLAM</b>			
RE10AK		Rectangular, yellow, self adhesive	12
RE10RK		Rectangular, red, self adhesive	12
RE12AK		Oblong, yellow, self adhesive/screw mount	12
RE12ARK		(2) each yellow and red RE11	12
RE15AK		Thinline, yellow, adhesive/screw mount	12
RE15RK		Thinline, red, adhesive/screw mount	12
RE52ARK		(2) each yellow and red RE52	12

<b>FMVSS</b>	A
<b>MATERIALS</b>	Acrylic
<b>WARRANTY</b>	Three Year Warranty

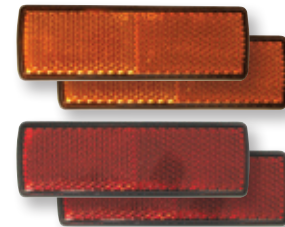
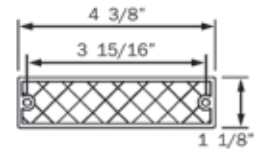
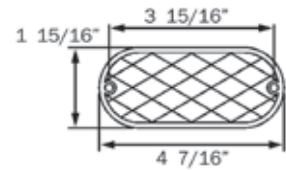
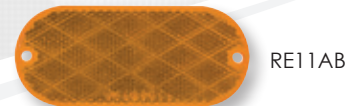
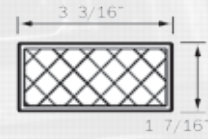
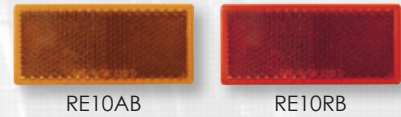

RE52ARK

4" W X 1.25" H X 0.75" D

# ROUND & OVAL REFLECTORS

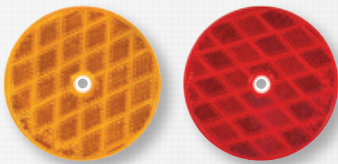

RE13AB

RE13RB

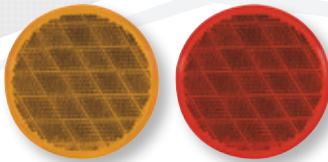
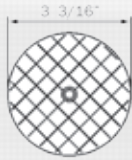

RE21AB

RE21RB

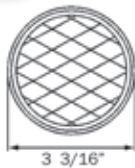

RE31AS

RE31RS

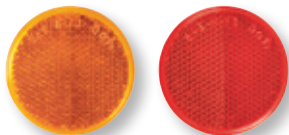
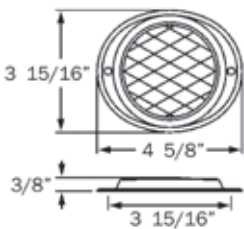

RE37AB

RE37RB

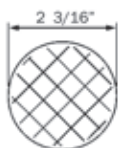

RE35AB

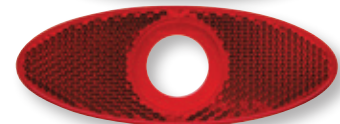
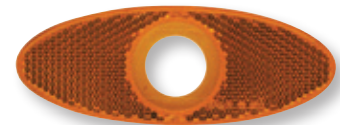
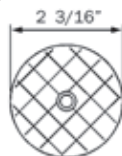

RE35RB

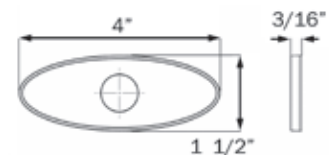

A11AXB / A11RXB



- Select from multiple shapes, sizes and mounting methods; available in bulk, polypack and retail clams
- Acrylic construction; meet FMVSS "A" for reflex when properly applied

BULK P/N	POLYPACK P/N	DESCRIPTION	QTY
<b>REFLECTORS</b>			
A11AXB	A11AXBP	Yellow reflector for 3/4" lights, self adhesive	100
A11RXB	A11RXBP	Red reflector for 3/4" lights, self adhesive	100
RE13AB	RE13ABP	3" round, yellow, center mount	50
RE13RB	RE13RBP	3" round, red, center mount	50
RE21AB	RE21ABP	3" round, yellow, self adhesive	50
RE21RB	RE21RBP	3" round, red, self adhesive	50
RE35AB	RE35ABP	2" round, yellow, center mount	100
RE35RB	RE35RBP	2" round, red, center mount	100
RE37AB	RE37ABP	2" round, yellow, self adhesive	100
RE37RB	RE37RBP	2" round, red, self adhesive	100
<b>RETAIL - CLAM</b>			
RE21AS		3" round, yellow, self adhesive	12
RE21RS		3" round, red, self adhesive	12
RE31AS		3" armored aluminum, yellow, screw mount	12
RE31RS		3" armored aluminum, red, screw mount	12

<b>FMVSS</b>	A
<b>MATERIALS</b>	Acrylic
<b>WARRANTY</b>	Three Year Warranty

REFLECTORS

## 3/4" GROMMETS & BRACKETS

### Grommets and Brackets for 3/4" Round Sealed Lights

- PVC grommets for flush mount of 3/4" round lights
- Snap-in mounting flange for secure installation
- Stainless steel trim ring covers grommet
- License plate light brackets for use with LPL12CB

BULK P/N	POLYPACK P/N	DESCRIPTION	QTY
<b>GROMMETS &amp; BRACKETS</b>			
A10BB	A10BBP	Surface mount base, black	100
A10GB	A10GBP	Sealing grommet	100
A11GB	A11GBP	Standard grommet	100
A11DB	A11DBP	Adaptor cover 2" and 2.5" holes, accepts 3/4" lights	50
A12GB	A12GBP	Sealing grommet, for material thickness .070-.125"	100
A14GB	A14GBP	Sealing grommet, for material thickness .1250-.250"	100
A11PB	A11PBP	Snap-in mounting flange	100
<b>REFLECTORS/TRIM RINGS</b>			
A11AXB	A11AXBP	Yellow reflector, self adhesive	100
A11RXB	A11RXBP	Red reflector, self adhesive	100
A11SSB	A11SSBP	Stainless steel trim ring	100
<b>LICENSE PLATE LIGHT BRACKETS/ACCESSORIES</b>			
A11GLPB	A11GLPBP	License light bracket, gray	50
A11BLPB	A11BLPBP	License light bracket, black	50
A12B2LPB	A12B2LPBP	Vertical license light bracket	50
A12GLPB	A12GLPBP	Grommet for A12B2LPB bracket	50

P/N	MATERIALS	WT/DIMS
A10BB	ABS	
A10GB	PVC	
A11GB	PVC	.05 lb. / 1.083" x 1.083" x 0.456"
A11DB	ABS	.038 lb. / 3.563" x 3.563" x .375"
A12GB	PVC	.05 lb. / 1.094" x 1.094" x 0.465"
A14GB	PVC	.05 lb. / 1.094" x 1.094" x 0.465"
A11PB	Polycarbonate	.05 lb. / 1.156" x 1.156" x 0.75"
A11SSB	Stainless steel	.05 lb. / 1.313" x 1.313" x 0.125"
A11GLPB/BLPB	Polycarbonate	.08 lb. / 2.25" x 1.375" x 0.625"
A12GLPB	PVC	.12 lb. / 3.438" x 2.688" x 2.313"
A11AXB/RXB	Acrylic	.05 lb. / 4" x 1.5" x 0.188"



A10BB



A10GB

A11GB  
A12GB  
A14GB



A11DB



A11PB



A11SSB

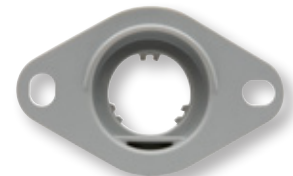

A11GLPB



A12B2LPB bracket shown with light and A12GLPB grommet

## 2" GROMMETS & ACCESSORIES

### Grommets, Mounting Brackets and Trim Rings for 2" Round Lights

- PVC grommet for flush mount of 2" round lights provides shock mount to lengthen bulb life
- Choice of two surface mount brackets
- Trim rings for grommet or flange mount lights, screw mount

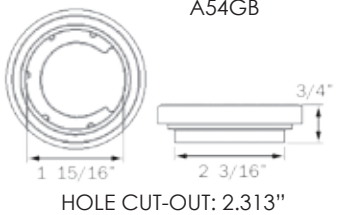

BULK P/N	POLYPACK P/N	DESCRIPTION	QTY
<b>MOUNTING ACCESSORIES</b>			
A53GB	A53GBP	Extra-flex flush mount grommet	100
A54GB	A54GBP	Flush mount grommet	100
A54GK	A54GKP	Kit: A54GB & A46PB PL-10 plug	100
BK5557GB	BK5557GBP	Cam-on mounting bracket	50
A55CB	A55CBP	Chrome trim ring, grommet mount	20
A3TRSSB	A3TRSSBP	Stainless steel trim ring, flange mount	100
BK53BB	BK53BBP	Branch deflector bracket, gray	50

<b>WIRING ACCESSORIES</b>			
A46PB	A46PBP	Two-pin plug with 6" lead, #10 terminal on ground	50

P/N	MATERIALS	WT/DIMS
A53GB	PVC	.05 lb. / 3" x 3" x 1"
A54GB	PVC	.05 lb. / 2.625" x 2.625" x 0.75"
BK5557GB	ABS	.05 lb. / 4" x 2.125" x 1"
A55CB	ABS	.05 lb. / 3.25" x 3.25" x 0.438"
A3TRSSB	Stainless steel	.05 lb. / 3.063" x 3.063" x 0.125"
BK53BB	ABS	.05 lb. / 5.375" x 2.75"

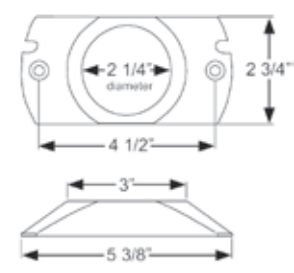
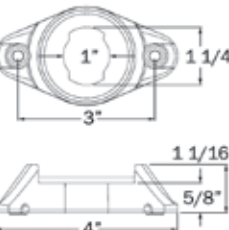
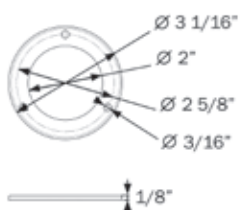
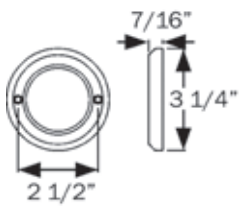

MOUNTING & WIRING ACCESSORIES

## 2.5" GROMMETS

### Mounting Grommets for 2.5" Round Sealed Lights

- PVC grommets for flush mount of 2.5" round lights
- Grommet provides shock mount to lengthen bulb life

BULK P/N	POLYPACK P/N	DESCRIPTION	QTY
<b>MOUNTING ACCESSORIES</b>			
A55GB	A55GBP	Open back, flush mount, black	50
A55GK	A55GKP	Kit: A55GB & A46PB PL-10 plug	100
A55GWB	A55GWBP	Open back, flush mount, white	50
A56GB	A56GBP	Closed back, recess mount, black	100
A57GB	A57GBP	Open back, recess mount, black	50
A57GK	A57GKP	Kit: A57GB & A46PB PL-10 plug	100
A58GB	A58GBP	Angled grommet, black	100
<b>WIRING ACCESSORIES</b>			
A46PB	A46PBP	PL-10 plug with 6" lead, #10 terminal on ground	100

P/N	MATERIALS	WT/DIMS
A55GB/GWB	PVC	.132 lb. / 3.5" x 3.5" x .938"
A56GB	PVC	.132 lb. / 3.25" x 3.25" x 1.125"
A57GB	PVC	.11 lb. / 3.25" x 3.25" x 1.125"
A58GB	PVC	.132 lb. / 3.438" x 3.438" x 0.875"



A55GB

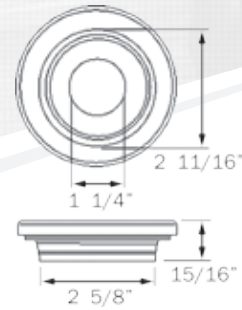

HOLE CUT-OUT: 3"



A56GB

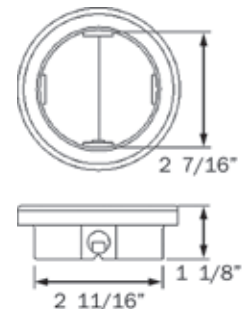

HOLE CUT-OUT: 2.75"



A57GB

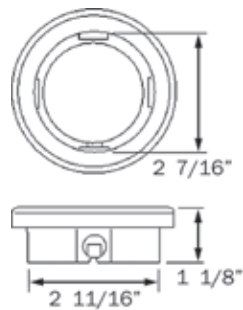

HOLE CUT-OUT: 2.75"



A58GB

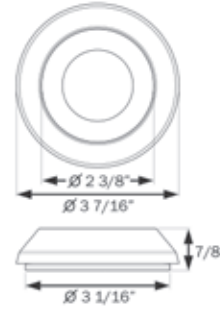

HOLE CUT-OUT: 2.75"

## 2.5" BRACKETS & TRIM RINGS

### Mounting Brackets and Ornamental Trim Rings for 2.5" Round Sealed Lights

- Choice of three brackets for surface mount of 2.5" round sealed lights
- Trim rings for grommet or flange mount lights, screw mount



BK55BB

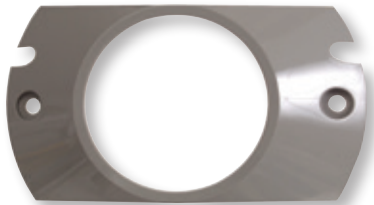
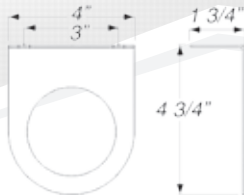

BK57BB

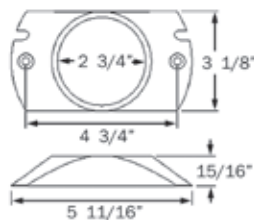

A25TRSSB

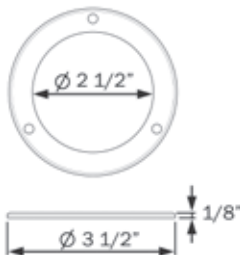

A57CB

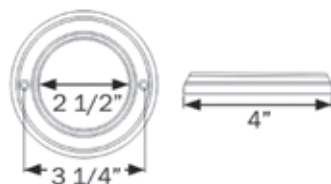

BK5557GB

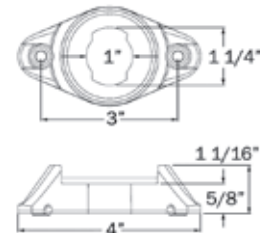

BULK P/N	POLYPACK P/N	DESCRIPTION	QTY
<b>MOUNTING ACCESSORIES</b>			
BK55BB	BK55BBP	Black steel bracket for use with grommet; no cut-out in trailer frame required	20
BK57BB	BK57BBP	Surface mount branch deflector bracket, gray plastic	50
BK5557GB	BK5557GBP	Cam-on mounting bracket with built-in branch deflector, suitable for use with PC rated lights	50
A25TRSSB	A25TRSSBP	Stainless steel trim ring, flange mount	50
A57CB	A57CBP	Chrome trim ring, grommet mount	20

P/N	MATERIALS	WT/DIMS
BK55BB	Steel	.375 lb. / 4" x 4.75" x 1.75"
BK57BB	Polycarbonate	.066 lb. / 5.688" x 3.125" x 0.938"
BK5557GB	Plastic	.066 lb. / 4" x 2.125" x 1"
A25TRSSB	Stainless steel	.04 lb. / 3.5" x 3.5" x 0.125"
A57CB	Plastic	.11 lb. / 4" x 4" x 0.415"



## MC65/A67 SERIES BRACKETS

### Mounting Brackets for MCL61 & MC/MCL65 Series Lights

- Corrosion proof brackets for surface mount of 61/65 series lights
- Single wire design grounds through mounting hardware
- Two-wire design includes both lead and ground wires
- A67 series brackets for use in exterior (top) fender applications with MC65ARB, MCL61ARB and MCL65ARB

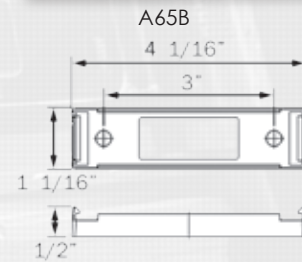

BULK P/N	POLYPACK P/N	DESCRIPTION	QTY
<b>SURFACE MOUNT BRACKETS</b>			
A65B	A65BP	Black bracket only	50
A65PB	A65PBP	Kit: A65B & A65P single wire plug	50
A65PBPG	A65PBPGP	Kit: A65B & A65P single wire plug with .180 molded male bullet	50
A65TB	A65TBP	Black bracket only, thick base	50
A66PB	A66PBP	Kit: Gray bracket & A65P single wire plug	50
A67CB	A67CBP	Kit: Chrome bracket & A65P, 12" lead	50
A67CBPG	A67CBPGP	Kit: Chrome bracket & single wire plug with .180 molded male bullet, 18" lead	50
A67P10G	A67P10GP	Kit: Chrome bracket & single wire plug with .180 molded male bullet, 10" lead	100
A68PB	A68PBP	Kit: A65B & A68P two-wire plug	50
A65PRXB	A65PRXBP	Kit: Black bracket with red reflector installed & single wire plug	50
<b>SURFACE MOUNT FENDER BRACKETS</b>			
A67BB	A67BBP	Black fender bracket with self grounding, single wire plug	50
A67GB	A67GBP	Gray fender bracket with self grounding, single wire plug	50
A67CVB	A67CVBP	Curved gray fender bracket with self grounding, single wire plug; curved to fit radius of trailer fender	50
<b>WIRING ACCESSORIES</b>			
A65P	A65PP	One-wire plug, grounds through mounting hardware	50
A68P	A68PP	Two-wire plug, includes lead and ground	50

P/N	MATERIALS
All brackets	Plastic

A91GB

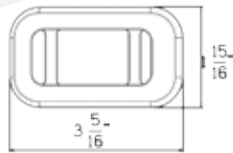
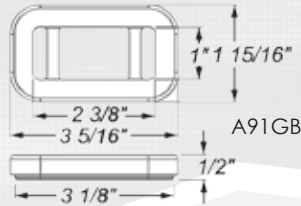

A91G15B1

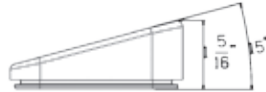

## 91 SERIES GROMMETS

### Mounting Grommets for A91, AL90, AL191 and AL91 Series Lights

- PVC grommets for flush mount of 90/91 series lights
- Provide shock mount to lengthen life of light
- A91G15B1 allows light to be mounted at 15 degrees

BULK P/N	POLYPACK P/N	DESCRIPTION	QTY
<b>GROMMETS</b>			
A91GB	A91GBP	Black grommet, flush mount	100
A91GOB	A91GOBP	Black open back grommet	100
A91G15B1	A91G15B1P	Black 15 degree angled grommet	100
A91GZB	-	Black vertical mount grommet	50
<b>WIRING ACCESSORIES</b>			

A46PB	A46PBP	Two-wire plug, standard PL-10 connector	100
-------	--------	---	-----

P/N	MATERIALS	WT/DIMS
A91GB/GOB	PVC	.066 lb. / 3.313" x 1.938" x 0.5"
A91G15B1	PVC	.066 lb. / 3.313" x 1.938" x 1.313"



A91CB

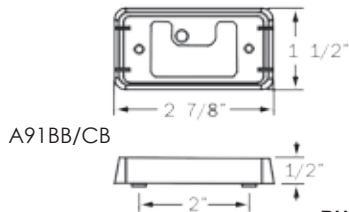

A91BOB

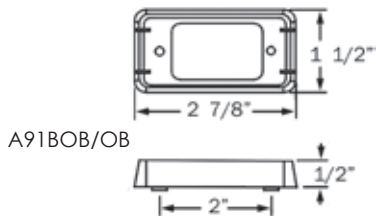

A91BOB/OB

## 91 SERIES BRACKETS

### Mounting Brackets for A91, AL90, AL191 and AL91 Series Lights

- Corrosion proof brackets for surface mount of 90/91 series lights
- Self grounding bases ground through mounting hardware and should be used with A91LW plug
- Open back bases should be used with A46PB two-wire plug

BULK P/N	POLYPACK P/N	DESCRIPTION	QTY
<b>SURFACE MOUNT BRACKETS</b>			
A91BB	A91BBP	Black base, self grounding	100
A91BOB	A91BOBP	Black base, open back	100
A91CB	A91CBP	Chrome base, self grounding	100
A91OB	A91OBP	Chrome base, open back	100
<b>WIRING ACCESSORIES</b>			

A91LW	A91LWP	Single wire plug, molded male bullet	100
A46PB	A46PBP	Two-wire plug, standard PL-10 connector	100

P/N	MATERIALS
All Brackets	Plastic

# 4" ROUND GROMMETS & BRACKETS

## Mounting Grommets & Brackets for Sealed 4" Round Lights

- PVC grommets for flush mount of 45 series lights; grommet provides shock mount to lengthen life of light
- Mounting flanges for flush mount of 45 series lights; lights snap into flange
- Steel bracket mounts to trailer frame; no panel cutout required. Use with A45GB grommet. Durable powder coated finish.



A45GB

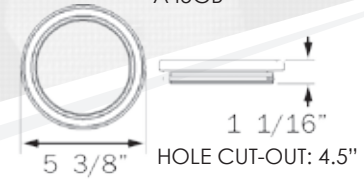

BULK P/N	POLYPACK P/N	DESCRIPTION	QTY
<b>GROMMETS</b>			
A45GB	A45GBP	PVC grommet, flush mount	50
A46GB	A46GBP	Extra-flex PVC grommet, flush mount	50
<b>BRACKETS</b>			
A45BB	A45BBP	Black plastic mounting flange	100
A45SB	A45SBP	Stainless steel mounting flange	20
BK45BB	BK45BBP	Steel mounting bracket, powder coated	10

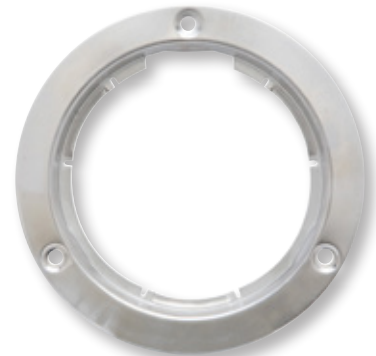

A45SB

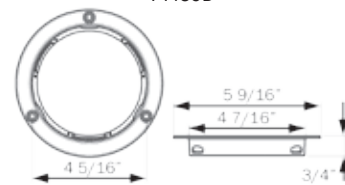

P/N	MATERIALS	WT/DIMS
A45GB	PVC	.176 lb. / 5.375" x 5.375" x 1.063"
A45BB	Plastic	.11 lb. / 5.5" x 5.5" x 1"
A45SB	Stainless steel	.19 lb. / 5.563" x 5.563" x 0.75"
A46GB	PVC	.05 lb. / 5.625" x 5.625" x 1.063"
BK45BB	Steel	.794 lb. / 6" x 5.813" x 1.375"

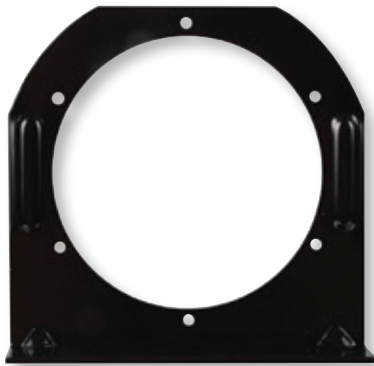

BK45BB

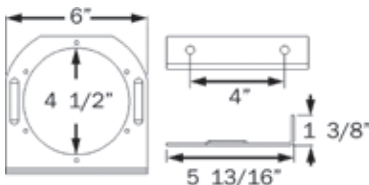

A46GB

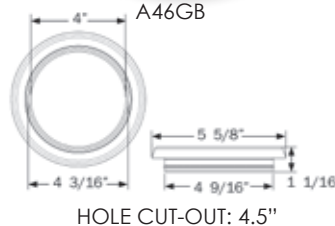

A45BB

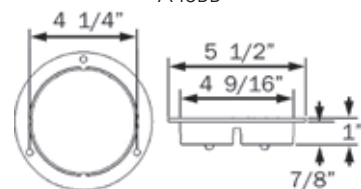

MOUNTING & WIRING ACCESSORIES

## 4" ROUND TRIM RINGS

### Trim Rings for Sealed 4" Round Lights



A5TRSSB / A42FCB

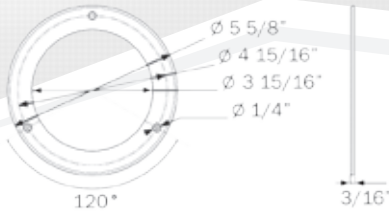

- Stainless steel models fit flange mount lights
- Chrome-plated plastic model fits grommet mount lights
- Trim rings mount using screws

BULK P/N	POLYPACK P/N	DESCRIPTION	QTY
<b>TRIM RINGS</b>			
A5TRSSB	A5TRSSBP	Stainless steel trim ring for flange mount lights	100
A42FCB	A42FCBP	Chromed metal trim ring for flange mount lights	100
A45CGB	A45CGBP	Chrome-plated plastic trim ring for grommet mount lights	20
A101TRSSB	A101TRSSBP	Stainless steel trim ring for STL/BUL101 flange mount lights	50



A45CGB

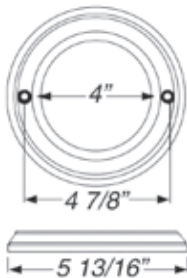

P/N	MATERIALS	WT/DIMS
A5TRSSB	Stainless steel	.132 lb. / 5.625" x 5.625" x 0.188"
A42FCB	Metal, chrome	.132 lb. / 5.625" x 5.625" x 0.188"
A45CGB	Plastic	.132 lb. / 5.813" x 5.813" x 0.5"
A101TRSSB	Stainless steel	.132 lb. / 5.625" x 5.625" x 0.188"



A101TRSSB



## 6" OVAL GROMMETS/BRACKETS

### Mounting Grommets & Brackets for Sealed 6" Oval Lights

- PVC grommets for flush mount of 70 series lights; grommet provides shock mount to lengthen life of light
- Steel brackets mount to trailer frame; no panel cutout required. Use with A70GB grommet or recess flange mount lights.

BULK P/N	POLYPACK P/N	DESCRIPTION	QTY
<b>GROMMETS</b>			
A70GB	A70GBP	PVC grommet, flush mount	50
A70GBD	A70GBDP	PVC grommet	50
A60GB	A60GBP	PVC grommet	50
<b>BRACKETS</b>			
BK70BB	BK70BBP	Steel mounting bracket, powder coated	10
A77SB	A77SBP	Steel mounting bracket, gray	20

P/N	MATERIALS	WT/DIMS
A70GB	PVC	.132 lb. / 7.625" x 3.375" x 1.125"
BK70BB	Steel	.728 lb. / 8.25" x 4" x 1.625"
A77SB	Steel	.132 lb. / 8.25" x 5.75" x 1.375"



A70GB



HOLE CUT-OUT: 6.85" x 2.5" (1.25" R)



BK70BB

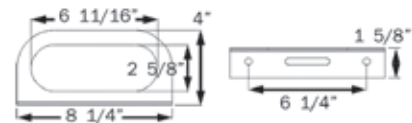

A77SB

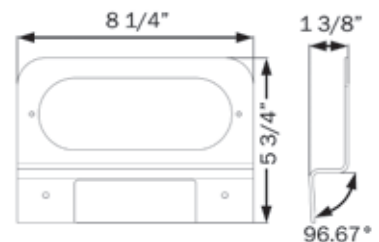

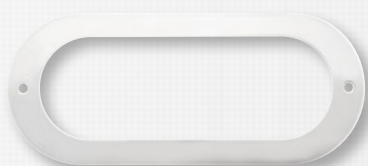

A7TRSSB

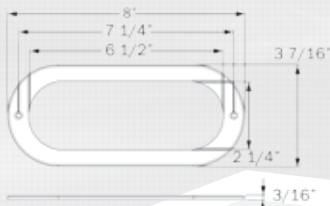

## 6" OVAL FLANGE COVERS

### Trim Rings for 6" Oval Sealed Flange Mount Lights

- Choose from stainless steel, chrome-plated plastic and red reflex models
- A7TRSSB mounts to STL75AMFB flange using screws
- A78CB1 and A78RXB snap onto flange/surface mount lights
- A78RXB fulfills rear reflex function, eliminating the need for a separate reflector



A78CB1

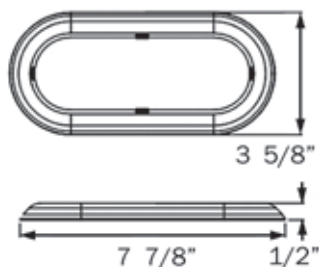

A78RXB

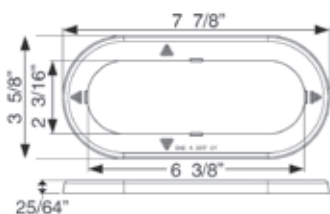

BULK P/N	POLYPACK P/N	DESCRIPTION	QTY
----------	--------------	-------------	-----

FLANGE COVERS			
A7TRSSB	A7TRSSBP	Stainless steel, screw mount (STL75AMFB)	100
A78CB1	A78CB1P	Chrome-plated plastic, snap-on	25
A78RXB	A78RXBP	Red reflex, snap-on	25
A111TRSSB	A111TRSSBP	Stainless steel screw mount trim ring for STL/BUL111 flange mount lights	50
A178TRSSB	A178TRSSBP	Stainless steel screw mount trim ring for STL178 flange mount lights	50

P/N	MATERIALS	WT/DIMS
A7TRSSB	Stainless steel	.066 lb. / 8" x 3.438" x 0.188"
A78CB1	ABS Plastic	.066 lb. / 7.875" x 3.625" x 0.5"
A78RXB	Acrylic	.066 lb. / 7.875" x 3.625" x 0.391"
A111TRSSB	Stainless steel	.066 lb. / 7.625" x 3.25" x 0.25"
A178TRSSB	Stainless steel	.066 lb. / 7.563" x 3.313" x 0.188"



A111TRSSB

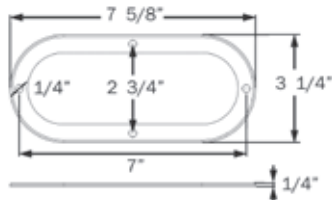

A178TRSSB

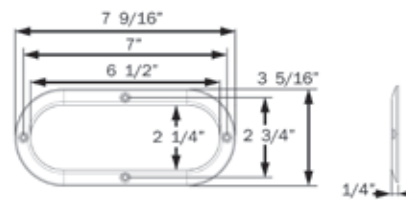

# MOUNTING ACCESSORIES

## Miscellaneous Mounting Grommets, Brackets & Accessories

- A33GB is PVC grommet for flush mount of 33/35 series lights; grommet provides shock mount to lengthen life of light
- BK42CB offers added protection for oblong, surface mount marker lights
- BK66DB offers added protection for MCL66 series lights
- A40SRB secures lens of ST series lights



A33GB

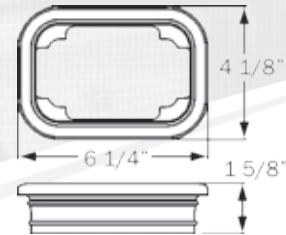

HOLE CUT-OUT: 5.453" x 3.578" (1" R)

BULK P/N	POLYPACK P/N	DESCRIPTION	QTY
<b>GROMMET - ST/STL33 SERIES</b>			
A33GB	A33GBP	PVC grommet, flush mount	50
<b>BRACKET - OBLONG M/C LIGHTS</b>			
BK42CB	BK42CBP	Steel mounting bracket, chrome plated	100
<b>BRACKET - MCL66 SERIES</b>			
BK66DB	BK66DBP	Heavy duty armored base for MCL66 series lights; die cast metal	50
<b>RETENTION RING - ST40 SERIES</b>			
A40SRB	A40SRBP	Snap ring for ST40 series lights	100

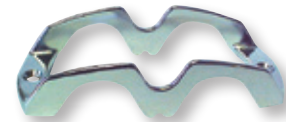

BK42CB

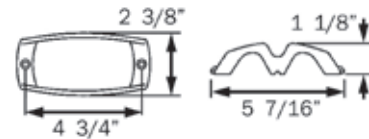

BK66DB



P/N	MATERIALS	WT/DIMS
A33GB	PVC	.353 lb. / 6.25" x 4.125" x 1.625"
BK42CB	Steel	.243 lb. / 5.438" x 2.375" x 1.125"
BK66DB	Aluminum	.132 lb. / 4.25" x 1.125" x 1.688"
A40SRB	Metal	.066 lb. / 5.125" x 0.125"

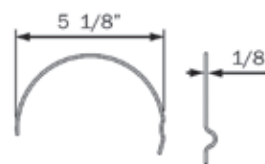

A40SRB

# MOUNTING ACCESSORIES

## Miscellaneous Mounting Bases & Bezels

- Chrome finish plastic mounting bases/bezels available for several light series; see details below
- Chrome finish plastic bezel for MCL48 and MCL73 dresses up light and covers mounting holes



A13C2B



A11SRB



A48CB



A94VB



A68SSB



A06TR



A69CB



A79CB



A71CCABWN

BULK P/N	POLYPACK P/N	DESCRIPTION	QTY
<b>BASES/BEZELS</b>			
A06TR	A06TRP	White trim ring	50
A09BB	A09BBP	UCL09 trim ring, black	50
A09CB	A09CBP	UCL09 trim ring, chrome	50
A09WB	A09BBP	UCL09 trim ring, white	50
A11SSB	A11SSBP	Stainless steel trim ring for 3/4" lights	100
A13C2B	A13C2BP	MCL/UCL13 base/bezel, chrome	100
A13B2B	A13B2BP	MCL/UCL13 base/bezel, black	100
A15BB	A15BBP	MCL15 base/bezel, black	100
A15CB	A15CBP	MCL15 base/bezel, chrome	100
A21CHB	A21CHBP	ILL21 bezel, chrome	25
A48CB	A48CBP	MCL48 & MCL73 bezel, chrome	50
A68SSB	A68SSB	Stainless steel snap-on trim ring for STL68RB	20
A69CB	A69CBP	STL69 & MCL70 base/bezel, chrome	10
A69RXCB	A69RXCBP	STL69RRXB base/bezel, chrome	10
A71CBAWN	A71CBAWN	Chrome finish plastic base for ILL71CBAWN	10
A79CB	-	MCL78/88 and STL79/80/89/90 series base/bezel, chrome	10
A94VB	A94VP	Black steel visor for 7" warning lamps	25

P/N	MATERIALS	WT/DIMS
A06TR	ABS	.06 lb. / 11" x 4" x .25"
A09BB/CB/WB	ABS	.06 lb. / 3.421" x 3.421" x .287"
A11SRB	SS	.02 lb. / 1.5" x 1.5" x .125"
A13C2B/B2B	ABS	.088 lb. / 3.236" x 1.791" x .43"
A15BB/CB	ABS	.088 lb. / 3.938" x 1.374" x .5"
A21CHB	ABS	.088 lb. / 6.313" x 6.313" x .563"
A48CB	ABS	.088 lb. / 6" x 2.25" x 1.125"
A68SSB	SS	.088 lb / 10.125" x 3" x .375"
A69CB	ABS	.176 lb. / 16.313" x 1.625" x 0.813"
A69RXCB	ABS	.176 lb. / 16.313" x 1.875" x 0.813"
A71CBAWN	ABS	.176 lb. / 18" x 2" x 1"
A79CB	ABS	.176 lb. / 18.875" x 2" x 0.813"
A94VB	Steel	.81 lb. / 7.25" x 7.25" x 4"



## LICENSE PLATE BRACKETS

- Select from heavy duty metal and corrosion proof plastic
- Accept stud mount license plate lights

BULK P/N	POLYPACK P/N	DESCRIPTION	QTY
<b>BRACKETS</b>			
LP5SB	LP5SBP	Black heavy duty plastic	100
LP10SB	LP10SBP	Black heavy duty plastic	50
LP15SB	LP15SBP	Zinc plated steel	12
LP20SB	LP20SBP	Powder coated steel	25
LP31SB	LP31SBP	Black heavy duty plastic for low temps	50
BK31BB	BK31BBP	Black heavy duty plastic	50
<b>RETAIL</b>			
LP10S		Black heavy duty plastic, clam	12
LP15S		Zinc plated steel, clam	12

P/N	MATERIALS	WT/DIMS
LP5SB	Plastic	.17 lb. / 8.25" x 4.25" x .813"
LP10SB	Plastic	.17 lb. / 9.5" x 4.813"
LP15SB	Steel	.397 lb. / 8.438" x 3.625" x 1.5"
LP20SB	Steel	.132 lb. / 8.5" x 2.875"
LP31SB	Plastic - low temp	.17 lb. / 8.25" x 4.25" x .813"
BK31BB	Plastic	.17 lb. / 8.25" x 4.25" x .813"



LP5SB

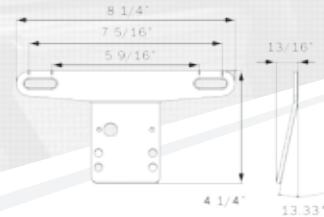

LP10SB

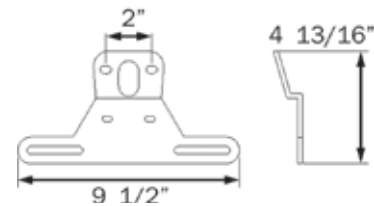

BK31BB  
LP31SB

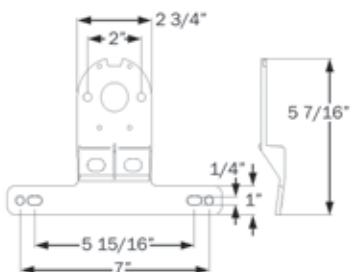

LP20SB

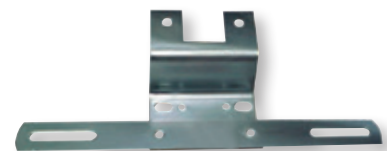
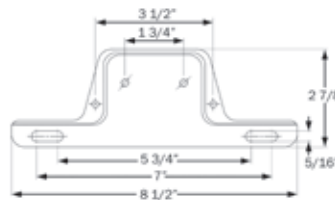

LP15SB

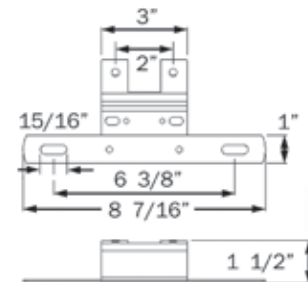

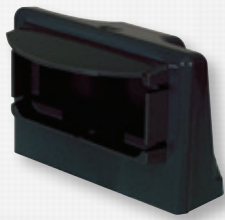

LP25SB

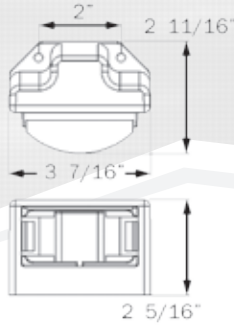

LP35BB

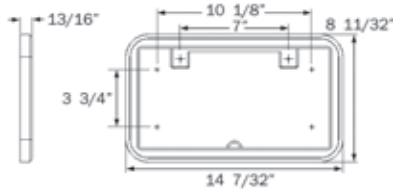

## LICENSE LIGHT BRACKETS & LICENSE PLATE HOLDER

- LP25SB surface mount bracket accepts LP91 and LPL91 series lights; mounting gasket sold separately
- LP35BB surface mount license plate holder is designed for mounting on flat surfaces

BULK P/N	POLYPACK P/N	DESCRIPTION	QTY
<b>LICENSE LIGHT BRACKETS</b>			
LP25SB	LP25SBP	Black bracket for LP/LPL91 lights	100
A25GB	A25GBP	Gasket for LP25SB	100
<b>LICENSE PLATE HOLDER</b>			
LP35BB	LP35BBP	Black license plate holder	25

P/N	MATERIALS	WT/DIMS
LP25SB/GGB	Polycarbonate	.066 lb. / 3.438" x 2.688" x 2.313"
LP35BB	Plastic	.122 lb. / 14.5" x 8.25"

## DOCUMENT HOLDER

- Twist-on cover with gasket protects documents from dirt and moisture while allowing convenient access
- Easy installation



DH55

BULK P/N	POLYPACK P/N	DESCRIPTION	QTY
<b>DOCUMENT HOLDER</b>			
DH55	DH55P	Document holder	10

P/N	MATERIALS	WT/DIMS
DH55	Polycarbonate	0.46 lb. / 5.5" x 5.5" x 2.125"

### 3-WIRE PIGTAILS

#### Wiring/Molded Plugs for Double Contact Sealed Lights

- A45PB & A47PB feature standard PL-3 plug with male pins, bare lead wires and #10 ring terminal on ground wire
- For use with stop/turn/tail, parking/turn and warning lights

BULK P/N	POLYPACK P/N	DESCRIPTION	QTY
<b>STANDARD PL-3</b>			
A45PB	A45PBP	Straight pigtail, 6"	100
A47PB	A47PBP	Right angle pigtail, 10"	100
A47PBB	A47PBBP	Straight pigtail, 10", no eyelet on ground	100
<b>WEATHERPROOF</b>			
A45PMB	A45PMBP	Weathertight plug to bare wire, 10"	50
AL45PWTB	AL45PWTBP	Weathertight plug with female PL-3, 10"	50
<b>RETAIL</b>			
A45PS		Straight pigtail, 6", clam	50
A47PS		Right angle pigtail, 10", clam	50
<b>WT</b>	All weigh approximately 0.044 lb. each		



A45PB

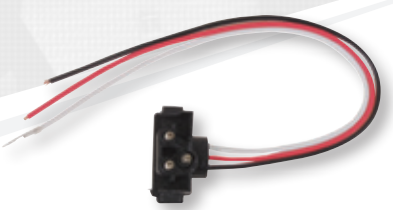

A47PB

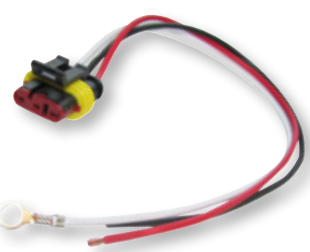

A45PMB

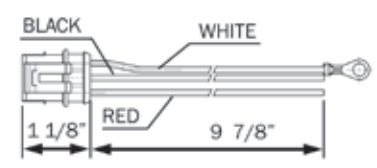

AL45PWTB



MOUNTING & WIRING ACCESSORIES



A42PMB

## 2-WIRE PIGTAILS

### Wiring/Molded Plugs for Single Contact Sealed Lights

- Standard two terminal plug with male pins, bare lead wire and #10 ring terminal on ground wire
- For use with back-up and utility lights



A45CB



A49PB



BULK P/N	POLYPACK P/N	DESCRIPTION	QTY
<b>TWO-WIRE PIGTAILS</b>			
A42PMB	A42PMBP	Weathertight pigtail, 10"	100
A45CB	A45CBP	Straight pigtail, 10"	100
A49PB	A49PBP	Right angle pigtail, 10"	100
A49PBB	A49PBBP	Right angle pigtail, 6", no eyelet on ground	100

WT All weigh approximately 0.044 lb. each

## 2-WIRE PIGTAILS

### Wiring/Molded Plugs for Sealed Marker/Clearance & Utility Lights

- Pigtails feature standard PL-10 plug with male pins; bare lead wires and #10 ring terminal on ground wire unless noted in description
- For use with sealed marker/clearance and utility lights



AL42PB



A46PB



BULK P/N	POLYPACK P/N	DESCRIPTION	QTY
<b>TWO-WIRE PL-10 PLUGS</b>			
A12PB	A12PBP	12" adaptor, .180 male bullets to .180 female barrels	100
AL42PB	AL42PBP	MCL42 weathertight pigtail	100
AL42PG	AL42PGP	MCL42 weathertight pigtail, .180 bullets	100
A46PB	A46PBP	Straight pigtail, 6"	100
A46PBB	A46PBBP	Straight pigtail, 6", no eyelet on ground	100
A46PPG	A46PPGP	Straight pigtail, 6", male plug on power	100
A46P135B	-	Straight pigtail, 135", no ring terminal on ground wire	100
A46P75B	-	Straight pigtail, 75", no ring terminal on ground wire	100
A46P36B	-	Straight pigtail, 36", no ring terminal on ground wire	100
A86PB	A86PBP	Straight pigtail, 18"	100

#### RETAIL

A46PS		Straight pigtail, 6", clam	12
-------	---	----------------------------	----

WT All weigh approximately 0.044 lb. each

## ID LIGHT BAR HARNESS

### Wiring/Molded Plugs for 3-Pc Sealed Identification Light Bars

- Standard two terminal plugs with male pins; 65" bare lead wire and #10 ring terminal on 19" ground wire
- For use with identification light bars featuring sealed lights



A93PB

BULK P/N	POLYPACK P/N	DESCRIPTION	QTY
<b>ID LIGHT BAR HARNESS</b>			
A93PB	A93PBP	ID light bar harness	100

WT 0.4 lb.



A91LW



## SINGLE WIRE PLUG

### Wiring/Molded Plug for Marker/Clearance & Utility Lights

- Standard molded .180 male plug with 12" lead wire
- For use with sealed marker/clearance and utility lights installed in self-grounding base

BULK P/N	POLYPACK P/N	DESCRIPTION	QTY
<b>SINGLE WIRE PLUG</b>			
A91LW	A91LWP	Single wire plug, 12"	100
A91LRW	A91LRWP	Single wire plug, 7", red	500
WT	0.044 lb.		



A65P



A68P

## SINGLE & TWO-WIRE PLUGS

### Wiring/Molded Plug for Thinline Marker/Clearance & Utility Lights

- Standard .156 male bullet on 6" lead wire
- Molded plug fits into surface mount bracket for MC/MCL/UL/UCL65 and MCL61 series lights
- Single wire plug grounds through mounting hardware
- Two-wire plug includes both lead and ground wire

BULK P/N	POLYPACK P/N	DESCRIPTION	QTY
<b>MOLDED PLUGS FOR THINLINE LIGHTS</b>			
A65P	A65PP	Single wire plug, 6"	50
A68P	A68PP	Two-wire plug, 6"	50
WT	Plugs weigh approximately 0.044 lb. each		

## TRUNK & TRAILER CONNECTORS



- A10TH5B tongue extension features 5-way flat plug with one female/four male pins on one end; on other end 5-way flat plug with one male/three female pins, female barrel on blue wire
- A4TC4WB and A6TC4WB trunk connectors feature 4-way flat plug with three female/one male pins
- A18TC replacement trailer connector has one female/ three male pins; A185TC has one female/four male pins
- A48TC replacement trunk connector has one male/three female pins



A48TC



A18TC

BULK P/N	POLYPACK P/N	DESCRIPTION	QTY
<b>CONNECTORS</b>			
A10TH5B	A10TH5BP	5-way harness tongue extension, 10-ft	50
A4TC4WB	A4TC4WBP	4-way to bare wire, 4-ft	100
A6TC4WB	A6TC4WBP	4-way to bare wire, 6-ft	50
<b>RETAIL</b>			
A18TC		4-way trailer connector, 18", clam	12
A185TC		5-way trailer connector, 18", clam	12
A48TC		4-way trunk connector, 4-ft, clam	12

## 7-5 WAY ADAPTORS/PLUGS

Converts two vehicle 7-way round blade connector to 5-way flat pin connector





A57WB



A75TB



A7WCB

BULK P/N	POLYPACK P/N	DESCRIPTION	QTY
<b>7-5 WAY ADAPTORS</b>			
A57WB	A57WBP	5-flat to 7-round, 16" cable	25
A75TB	A75TBP	5-flat to 7-round, single piece	50
A7WCB	A7WCBP	7-way power plug, round	50
<b>RETAIL</b>			
A57WH		5-flat to 7-round, 16" cable, clam	6
A75TC		5-flat to 7-round, single piece, clam	12

## 4-WAY WISHBONE STYLE WIRING HARNESSSES

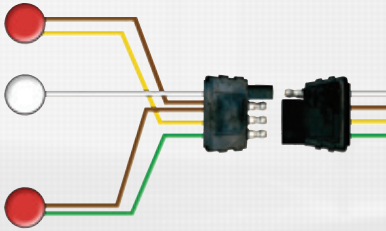

Split wishbone four-conductor harnesses

**WIRE DESCRIPTIONS:**

WHITE - GROUND  
 BROWN - TAIL LAMPS  
 YELLOW - DRIVER SIDE STOP/TURN  
 GREEN - PASSENGER SIDE STOP/TURN

BULK P/N	POLYPACK P/N	DESCRIPTION	QTY
<b>4-WAY HARNESSSES</b>			
A20WB	A20WBP	20-ft	50
A25WB	A25WBP	25-ft	50
A25R10WB	A25R10WBP	25-ft, #10 ring terminal on ground	50
A25W42B	A25W42BP	25-ft, 42" ground wire	50
A30WB	A30WBP	30-ft	50
A30W10B	A30W10BP	30-ft, 10-ft ground wire	50
A35WB	A35WBP	35-ft	25
A35R10WB	A35R10WBP	35-ft, #10 ring terminal on ground	25
A35W42B	A35W42BP	35-ft, 42" ground wire	50
A36WRB	A36WRBP	36-ft ribbon wiring harness	25
A40W42B	A40W42BP	40-ft with tubing, 42" ground wire	25
<b>RETAIL</b>			
A25WH		25-ft harness with 4-ft trunk connector, clam	6

## 5-WAY WISHBONE STYLE WIRING HARNESSSES

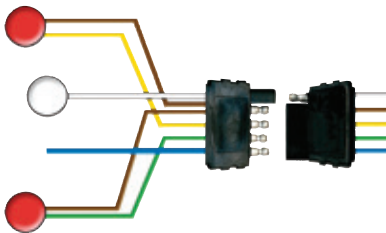

Split wishbone five-conductor harnesses have fifth wire for lights or brakes

**WIRE DESCRIPTIONS:**

WHITE - GROUND  
 BROWN - TAIL LAMPS  
 YELLOW - DRIVER SIDE STOP/TURN  
 GREEN - PASSENGER SIDE STOP/TURN  
 BLUE - AUXILIARY USE

BULK P/N	POLYPACK P/N	DESCRIPTION	QTY
<b>5-WAY HARNESSSES</b>			
A25W5B	A25W5BP	25-ft, 30" ground, 5-ft blue wire	25
A30W5B	A30W5BP	30-ft, 30" ground, 5-ft blue wire	25
A30W5BLB	-	30-ft, 40" ground, 30-ft blue wire	25
A35W5B	A35W5BP	35-ft, 30" ground, 5-ft blue wire	25
A40W5B	A40W5BP	40-ft, 30" ground, 5-ft blue wire	25
<b>RETAIL</b>			
A255WH		25-ft harness with 4-ft trunk connector, clam	6



## REPLACEMENT BULBS

BULK P/N	POLYPACK P/N	DESCRIPTION	QTY
<b>BULBS</b>			
A2057B	A2057BP	2057, 14V 32/2CP, 1200/5000 hour rating	50
A1157B	A1157BP	1157, 14V 26.9/8.3W, 1200/5000 hour rating	100
A194B	A194BP	194 wedge base, 14V 4CP, 2500 hour rating	100
A921B	A921BP	921 wedge base, 14V 21CP, 500 hour rating	100
<b>RETAIL</b>			
A400		Set, (1) each: 2057, 1157, 194, 168; clam	12
A700		12V 55W H3 quartz halogen, clam	12

## ALEDRST Series LED Load Resistor

- Upgrade from incandescent turn signals to LED models for safer, cost-efficient lights
- Makes turn signal flash at proper flash rate
- 50W, 6 ohm in-line resistor

BULK P/N	POLYPACK P/N	DESCRIPTION	QTY
<b>LOAD RESISTOR</b>			
ALEDRST1B	ALEDRST1BP	LED load resistor with lead	50
ALEDRST2B	ALEDRST2BP	LED load resistor with lead and female PL-3 plug	50

VOLT/AMP	WARRANTY
12V / 50W	Three Year Warranty

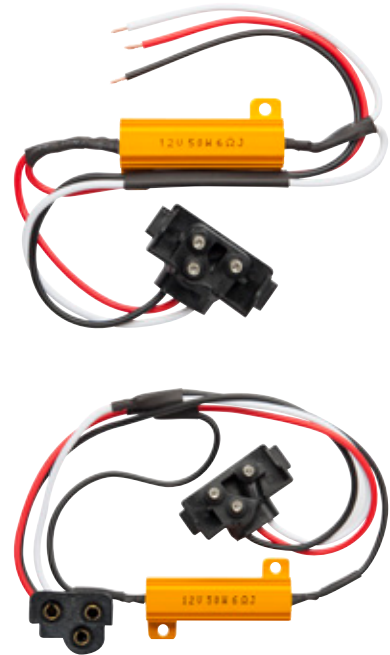

## BULK WIRE

BULK P/N	DESCRIPTION	QTY
<b>BULK WIRE</b>		
A0116AWGBLWSB	16AWG, Blue/White, 1,640-ft. spool	1
A0118AWGBRGRSB	18AWG Brown/Green, 1,640-ft. spool	1
A0118AWGBRSB	18AWG, Brown 2,985-ft. spool	1
A0118AWGBRYLWSB	18AWG, Brown/Yellow, 1,640-ft. spool	1
A0118AWGWHTSB	18AWG, White, 2,985-ft spool	1

## MOUNTING GASKETS

Closed cell foam gaskets provide weather tight seal to mounting surface

BULK P/N	POLYPACK P/N	DESCRIPTION	QTY
<b>GASKETS</b>			
A15GB	A15GBP	For MCL15 series, black	50
A13G2B	A13G2BP	For MCL/UCL13 series, black	200
A17GB	A17GBP	For MCL17 series, black	100
A25GB	A25GBP	For LP25SB license light bracket, black	100
A32GB	A32GBP	For MC32 series, white	500
A42GB	A42GBP	For ST40 & STL42 series, black	100
A44GTB	A44GTBP	Thick, for MC/MCL44 series, white	1000
A52GB	A52GBP	For MCL52 series, black	100
A66GB	A66GBP	For MCL66 series, black	100
A69GB	A69GBP	For MCL70/STL69 series, black	50
A73GB	A73GBP	For STL73 series, black	100

## MOUNTING HARDWARE

Hardware sets for mounting tail lights. See contents below. Components packaged separately.

BULK P/N	USE WITH	DESCRIPTION	QTY
<b>HARDWARE SETS</b>			
A830B	ST/STL16/17	(1) each: 1/4" 20 flange lock nut, 1/4" flat washer, 1/4" split lock washer; stainless	100
A839B	ST/STL16/17	(1) each: 1/4" 20 flange lock nut, 1/4" flat washer, 1/4" split lock washer; zinc plated	100



## FLASHER

BULK P/N	POLYPACK P/N	DESCRIPTION	QTY
<b>FLASHER</b>			
ALEDFB	ALEDFBP	LED flasher with connectors	10
<b>RETAIL</b>			
ALEDFS		LED flasher with connections, clam	12

## FEDERAL LIGHTING REGULATIONS FOR TRAILERS

**IMPORTANT NOTE:** Every lamp, reflex reflector, and conspicuity treatment must be permanently attached in the location specified below and must comply with all applicable requirements prescribed for it by FMVSS/CMVSS 108. The face of any device on the front/rear and sides should be, respectively perpendicular and parallel to the vehicle's centerline, unless it is photometrically certified at installation angle. No part of the vehicle shall prevent any device from meeting its prescribed requirements unless an auxiliary device meeting all prescribed requirements is installed. **IN CANADA:** Manufacturers and importers of vehicles must have the proper certification test records demonstrating compliance of lighting components with all prescribed requirements.



### BASIC EQUIPMENT REQUIRED ON ALL TRAILERS

DESCRIPTION				MANDATORY REQUIREMENTS			
Area	Equipment	SAE Lens Coding	Functional Purpose	Quantity	Color	Location	Height mm(in.) from the ground
1	Tail Lamps	(T)	Indicate vehicle's presence and width	Minimum 2	Red	On the rear - symmetrical as far apart as practicable	380-1830 (15-72)
	Stop Lamps	(S)	Indicate braking	Minimum 2	Red	On the rear - symmetrical as far apart as practicable	380-1830 (15-72)
	Rear Turn Signal Lamps	(I)	Indicate direction of turn	Minimum 2	Red or Yellow	On the rear - symmetrical as far apart as practicable	380-2110 (15-83)
	Rear Reflex Reflectors	(A)	Indicate vehicle's presence and width	Minimum 2	Red	On the rear - symmetrical as far apart as practicable facing rearward	380-1530 (15-60)
2	License Plate Lamp(s)	(L)	Illuminates license plate	Minimum 1	White	On the rear - above or at the sides of license plate	No requirement
3	Rear Side Marker Lamps <i>*photometrically certified at installation angle</i>	(P2, PC* or P3, PC2*)	Front and rear side marker lamps / side reflex reflectors indicate vehicle's presence and length	Minimum 2	Red	Each side at rear as far back as practicable	380-1530 (15-60) no max. for veh. under 2032mm (80") wide
	Rear Side Reflex Reflectors	(A)		Minimum 2	Red	Each side at rear as far back as practicable facing sideward	380-1530 (15-60)
4	a Front Side Marker Lamps <i>*photometrically certified at installation angle</i>	(P2, PC* or P3, PC2*)	Front and rear side marker lamps / side reflex reflectors indicate vehicle's presence and length	Minimum 2	Yellow	Each side at front as far forward as practicable	380 (15) minimum
	b Front Side Reflex Reflectors	(A)		Minimum 2	Yellow	Each side at front as far forward as practicable facing sideward	380-1530 (15-60)

### ADDITIONAL EQUIPMENT FOR TRAILERS EXCEEDING THE FOLLOWING PARAMETERS Length 9.1m (30 ft.) or longer

DESCRIPTION				MANDATORY REQUIREMENTS			
Area	Equipment	SAE Lens Coding	Functional Purpose	Quantity	Color	Location	Height mm(in.) from the ground
5	a Intermediate Side Marker Lamps	(P2 or P3)	Indicate presence of a long vehicle	Minimum 2	Yellow	Each side near center facing sideward	380 (15) minimum
	b Intermediate Side Reflex Reflectors	(A)	Indicate presence of a long vehicle	Minimum 2	Yellow	Each side near center facing sideward	380-1530 (15-60)

### Width 2032mm (80 in.) or wider

DESCRIPTION			MANDATORY REQUIREMENTS				
Area	Equipment	SAE Lens Coding	Functional Purpose	Quantity	Color	Location	Height
6	Rear Clearance Lamps <i>*photometrically certified at installation angle</i>	(P2, PC* or P3, PC2*)	Show vehicle's width MAY NOT be combined with tail lamps	Minimum 2	Red	At widest point - symmetrical on the rear or near the rear facing rearward	As high as practicable may be lower only if ID lamps are at the top
7	Rear Identification (ID) Lamps	(P2 or P3)	Indicate presence of a wide vehicle	Exactly 3	Red	On the rear - center horizontally spaced 150mm (6 in.) to 300mm (12 in.) apart facing rearward	At the top - may be lower if door header narrower than 25mm
8	Front Clearance Lamps <i>*photometrically certified at installation angle</i>	(P2, PC* or P3, PC2*)	Show vehicle's width	Minimum 2	Yellow	At widest point - symmetrical on the front or near the front facing forward	As high as practicable

### Width 2032mm (80 in.) or wider AND GVWR 4536 kg (10,000 lb.) or more

DESCRIPTION		MANDATORY REQUIREMENTS						Options
Area	Conspicuity Treatment	DOT Coding	Quantity	Color	Location	Height		
9	Rear Upper Body Markings	DOT-C DOT-C2 DOT-C3 DOT-C4	Exactly 2 pairs of 300mm long strips	White	On the rear upper corners facing rearward	At the top	Reflex reflectors may not be required if they are replaced in their required location with conspicuity treatment.  <b>Optional in Canada:</b> Rear lower body and side conspicuity treatment may also be solid white, solid yellow, or white and yellow.	
10	Bumper Bar Marking		Continuous	Red/White	On the rear bumper bar's horizontal element full width - facing rearward	No requirement		
11	Rear Lower Body Marking		Continuous	Red/White (see options)	On the rear full width of the vehicle facing rearward	As horizontal as practicable and as close as practicable to the range of 375 to 1525mm from the ground		
12	Side Marking		(see location)	Red/White (see options)	Each side - facing sideward continuous, or evenly spaced over minimum of 50% of length starts and ends as close to the front and rear of the vehicle as practicable	As horizontal as practicable and as close as practicable to the range of 375 to 1525mm from the ground		

**NOTE:** The edge of red conspicuity tape shall not be closer than 75 mm to the edge of any amber lamp and the edge of white conspicuity tape shall not be closer than 75 mm to the edge of any lamp

For more information contact: Transport Canada: Motor Vehicle Safety Enforcement Branch  
National Highway Traffic Safety Administration: Office of Safety Performance Standards

# FMVSS LIGHTING REQUIREMENTS – TRAILERS

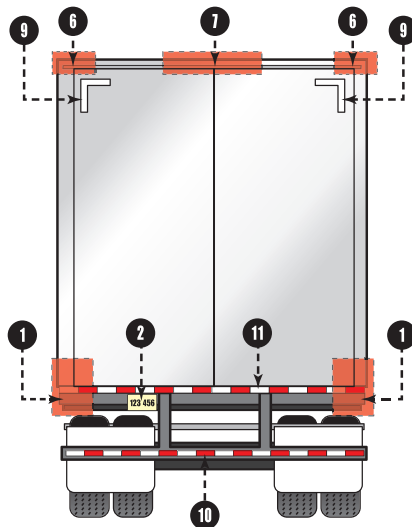
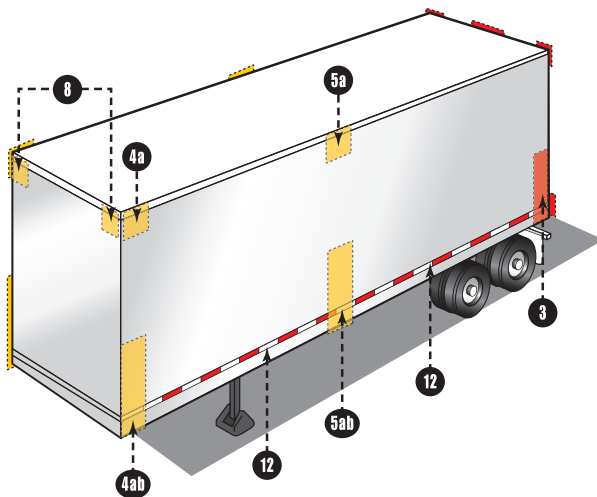
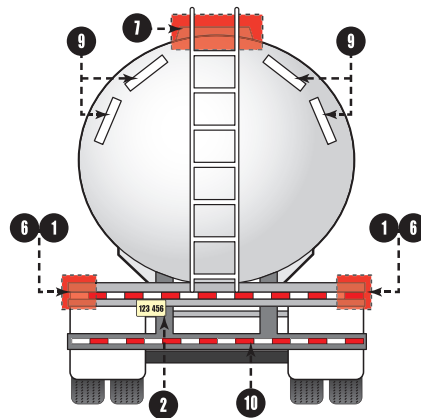
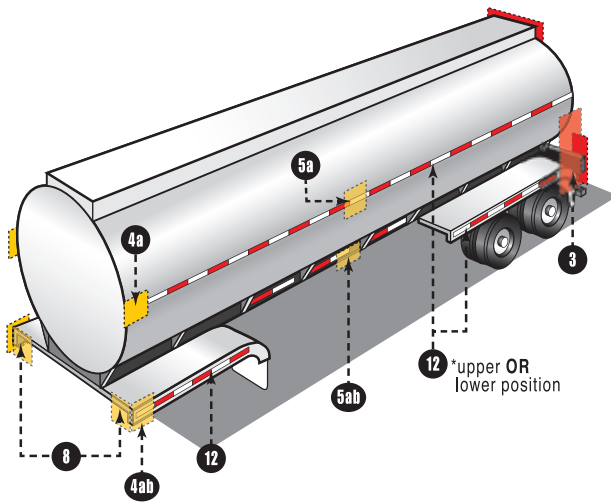
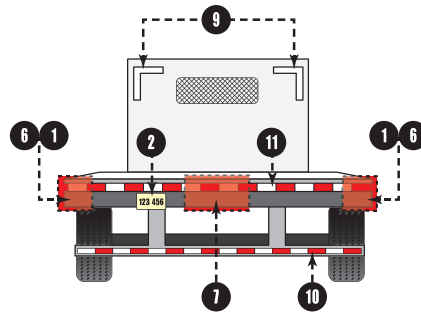
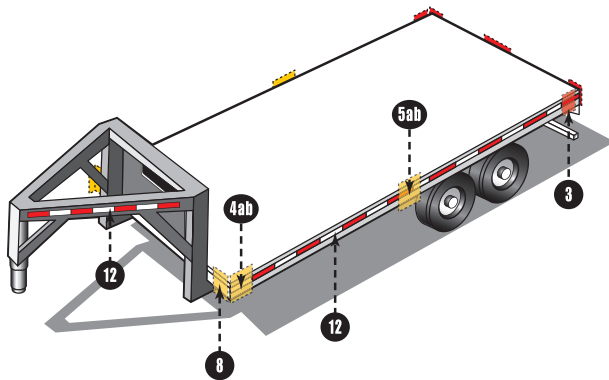
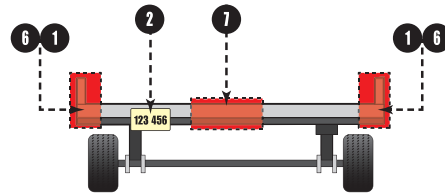
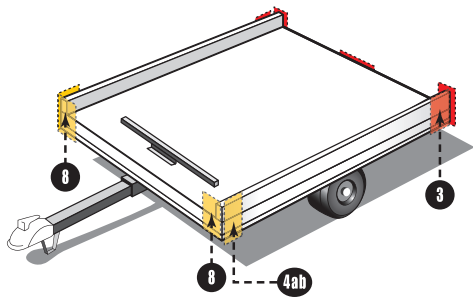

# FMVSS LIGHTING REQUIREMENTS – TRAILERS

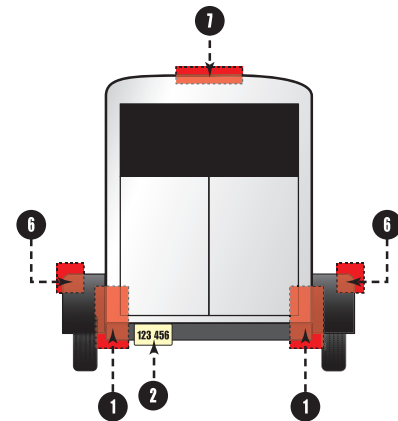
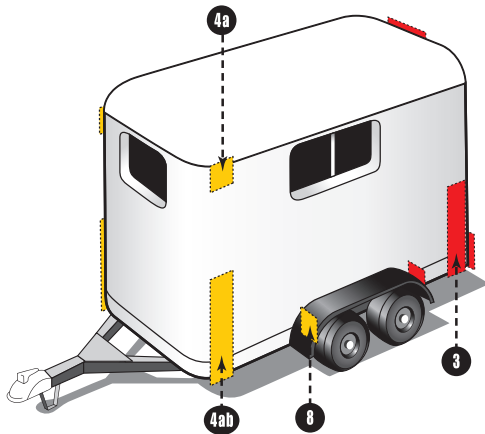
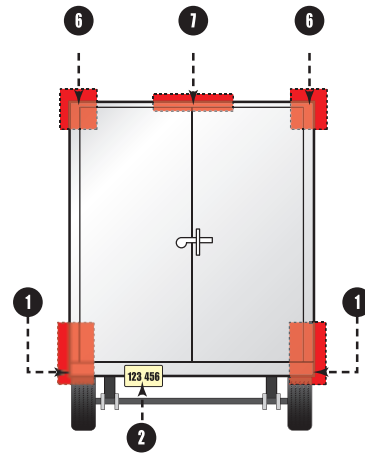
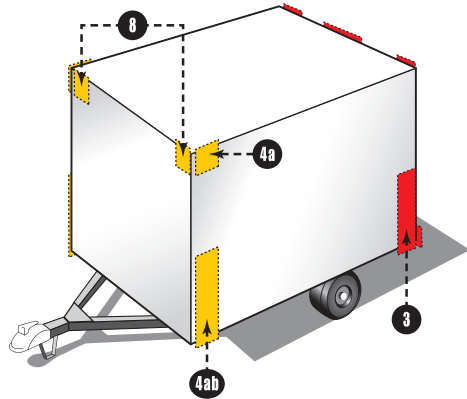
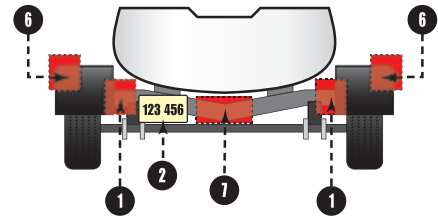
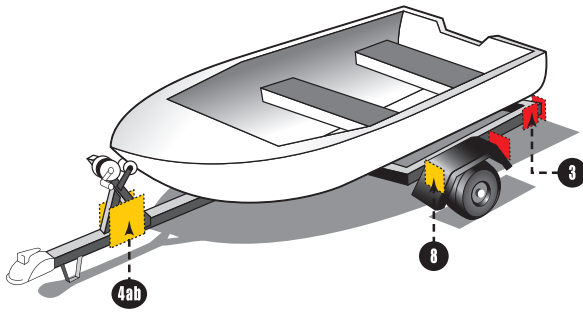
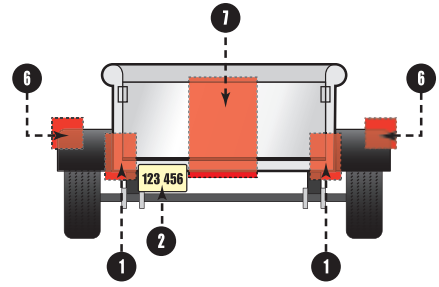
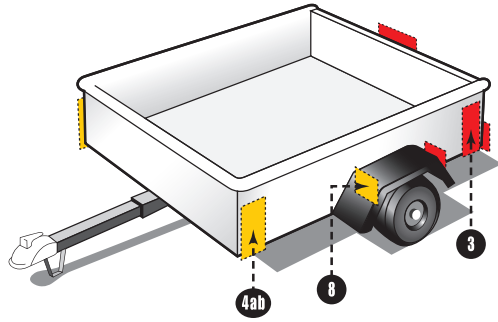

## FEDERAL LIGHTING REGULATIONS FOR TRUCKS, BUSES & MPVs

**IMPORTANT NOTE:** Every lamp, reflex reflector, and conspicuity treatment must be permanently attached in the location specified below and must comply with all applicable requirements prescribed for it by FMVSS/CMVSS 106. The face of any device on the front/rear and sides should be, respectively perpendicular and parallel to the vehicle's centerline, unless it is photometrically certified at installation angle. No part of the vehicle shall prevent any device from meeting its prescribed requirements unless an auxiliary device meeting all prescribed requirements is installed. **IN CANADA:** Manufacturers and importers of vehicles must have the proper certification test records demonstrating compliance of lighting components with all prescribed requirements.



### BASIC EQUIPMENT REQUIRED ON ALL TRUCKS, BUSES & MPVs

DESCRIPTION				MANDATORY REQUIREMENTS			
Area	Equipment	SAE Lens Coding	Functional Purpose	Quantity	Color	Location	Height mm(in.) from the ground
1	Headlamps - Lower Beam <small>US requires "DOT" lettering on lens US &amp; Canada - light source code required on lens</small>	(H, HR)	Forward road illumination	Minimum 2	White	On the front - symmetrical as far apart as practicable <small>If 4 lamp system - outboard or above upper beams</small>	560-1370 (22-54)
	Headlamps - Upper Beam <small>US requires "DOT" lettering on lens US &amp; Canada - light source code required on lens</small>	(H, HR)	Forward road illumination	Minimum 2	White	On the front - symmetrical <small>If 4 lamp system - inboard or below lower beams</small>	560-1370 (22-54)
	Parking Lamps <small>Vehicles less than 2032mm wide</small>	(P)	Indicate parked vehicle	Minimum 2	White or Yellow	On the front - symmetrical as far apart as practicable	380-1830 (15-72)
	Daytime Running Lamps (DRL) <small>Canada - required / US - option US requires "DRL" lettering on lens if not headlamp</small>	(Y2)	Indicate in use vehicle	Minimum 2	White or Yellow	On the front - symmetrical as far apart as practicable	380 (15) min. <small>Max. depends on type of DRL</small>
	Front Turn Signal/ Hazard Warning Lamps	(I)	Indicate direction of turn/ identify disabled vehicle	Minimum 2	Yellow	On the front - symmetrical as far apart as practicable	380-2110 (15-83)
2	Front Clearance Lamps <small>Vehicles 2032mm wide or wider *photometrically certified at installation angle</small>	(P2, PC* or P3, PC2*)	Show vehicle's width	Minimum 2	Yellow	At widest point - symmetrical on the front or near the front facing forward	As high as practicable
3	Front Identification Lamps (ID) <small>Vehicles 2032mm wide or wider</small>	(P2 or P3)	Indicate presence of a wide vehicle	Exactly 3	Yellow	On the front - center horizontally spaced 150mm (6 in.) to 300mm (12 in.) apart	As high as practicable or on top of the cab
4	a Front Side Marker Lamps <small>*photometrically certified at installation angle</small>	(P2, PC* or P3, PC2*)	Front and rear side marker lamps / side reflex reflector indicate vehicle's presence and length	Minimum 2	Yellow	Each side at front as far forward as practicable	380 (15) minimum
	b Front Side Reflex Reflectors	(A)		Minimum 2	Yellow	Each side at front as far forward as practicable facing sideward	380-1530 (15-60)
5	a Rear Side Marker Lamps** <small>*photometrically certified at installation angle</small>	(P2, PC* or P3, PC2*)	Rear and front side marker lamps / side reflex reflector indicate vehicle's presence and length	Minimum 2	Red	Each side at rear as far back as practicable	380 (15) minimum
	b Rear Side Reflex Reflectors** <small>**not required on Truck Tractors</small>	(A)		Minimum 2	Red	Each side at rear as far back as practicable facing sideward	380-1530 (15-60)
6	Rear Clearance Lamps <small>Vehicles 2032mm wide or wider Not required on Truck Tractors *photometrically certified at installation angle</small>	(P2, PC* or P3, PC2*)	Show vehicle's width MAY NOT be combined with tail lamps	Minimum 2	Red	At widest point - symmetrical on the rear or near the rear facing rearward	As high as practicable may be lower only if rear ID lamps are at the top
7	Rear Identification (ID) Lamps <small>Vehicles 2032mm wide or wider Not required on Truck Tractors</small>	(P2 or P3)	Indicate presence of a wide vehicle	Exactly 3	Red	On the rear - center horizontally spaced 150mm (6 in.) to 300mm (12 in.) apart facing rearward	At the top - may be lower if door header narrower than 25mm
8	Tail Lamps	(T)	Indicate vehicle's presence and width	Minimum 2	Red	On the rear - symmetrical as far apart as practicable	380-1830 (15-72)
	Stop Lamps	(S)	Indicate braking	Minimum 2	Red	On the rear - symmetrical as far apart as practicable	380-1830 (15-72)
	Rear Turn Signal/ Hazard Warning Lamps	(I)	Indicate direction of turn/ identify disabled vehicle	Minimum 2	Red or Yellow	On the rear - symmetrical as far apart as practicable	380-2110 (15-83)
	Rear Reflex Reflectors	(A)	Show vehicle's presence and width	Minimum 2	Red	On the rear - symmetrical as far apart as practicable	380-1530 (15-60)
9	Backup Lamp	(R)	Illuminates ground behind the vehicle and alert road users	Minimum 1	White	Rear	No requirement
10	License Plate Lamp(s)	(L)	Illuminates license plate	Minimum 1	White	On the rear - above or at the sides of license plate	No requirement
11	Center High Mounted Stop Lamp <small>Vehicles less than 2032mm wide and 4536kg</small>	(U3)	Indicates braking	1	Red	On the rear - centerline of the vehicle	860 (34) minimum

### ADDITIONAL EQUIPMENT FOR SPECIFIC VEHICLES VEHICLES 9.1m (30 ft.) LONG OR LONGER

DESCRIPTION				MANDATORY REQUIREMENTS			
Area	Equipment	SAE Lens Coding	Functional Purpose	Quantity	Color	Location	Height mm(in.) from the ground
12	a Intermediate Side Marker Lamps	(P2 or P3)	Indicate presence of a long vehicle	Minimum 2	Yellow	Each side near center	380 (15) minimum
	b Intermediate Side Reflex Reflectors	(A)	Indicate presence of a long vehicle	Minimum 2	Yellow	Each side near center facing sideward	380-1530 (15-60)

#### Truck Tractors

DESCRIPTION		MANDATORY REQUIREMENTS					
Area	Conspicuity Treatment	DOT Coding	Quantity	Color	Location	Height	Options
13	Rear Upper Body Markings	DOT-C DOT-C2 DOT-C3 DOT-C4	Exactly 2 pairs of 300mm long strips	White	Rear upper corners of cab facing rearward	As high as practicable excluding fairings	
14	Rear Marking		Exactly 2 sections of min. 600mm each	Red/White	Rear - facing rearward - on fenders, on mud flap brackets, or within 300mm below the top of mud flaps	As horizontal as practicable and not higher than 1525mm from the ground	If mud flaps not used - on the cab or frame mounted brackets

**NOTE:** The edge of red conspicuity tape shall not be closer than 75 mm to the edge of any amber lamp and the edge of white conspicuity tape shall not be closer than 75 mm to the edge of any lamp

For more information contact: Transport Canada: Motor Vehicle Safety Enforcement Branch  
National Highway Traffic Safety Administration: Office of Safety Performance Standards

# FMVSS LIGHTING REQUIREMENTS – TRUCKS/BUSES/MPV'S

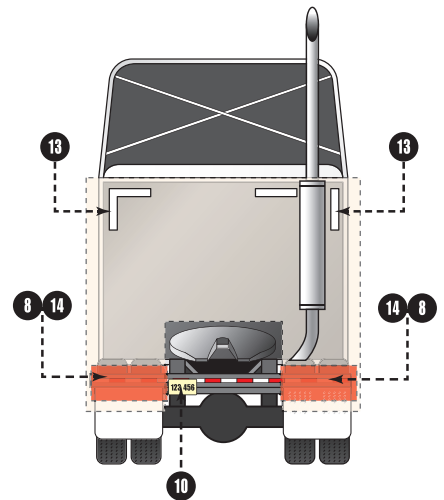
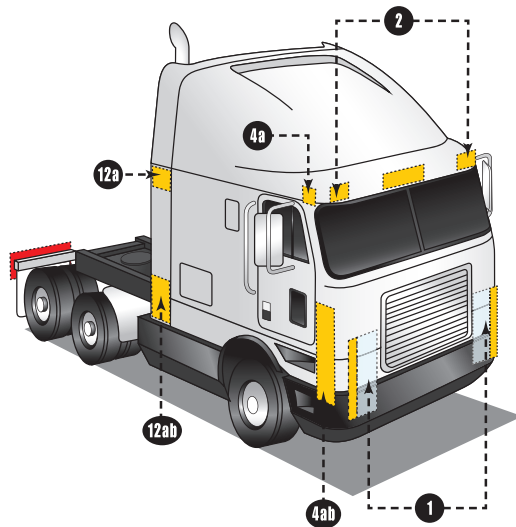
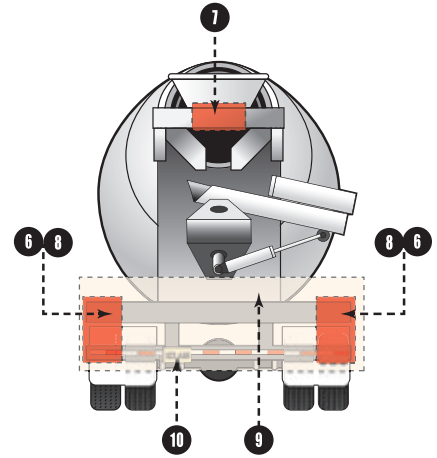
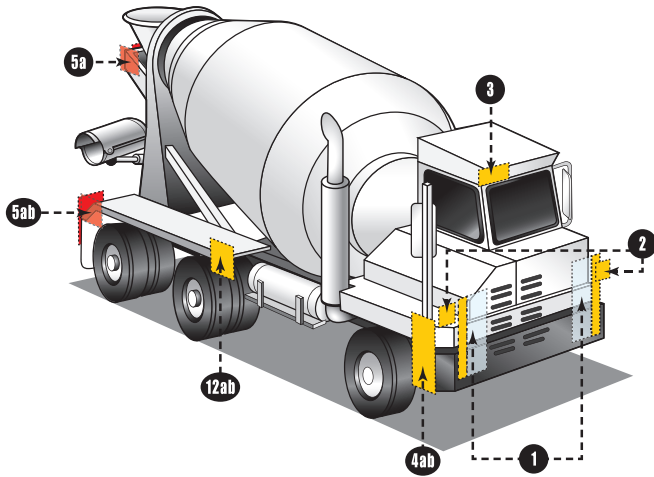
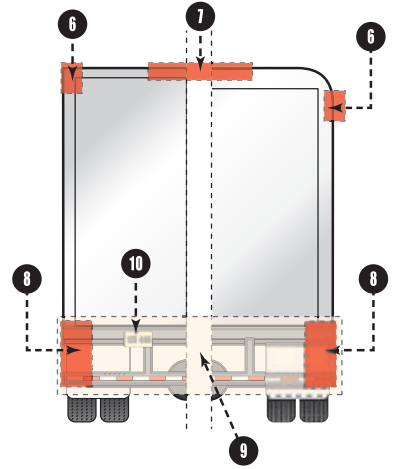
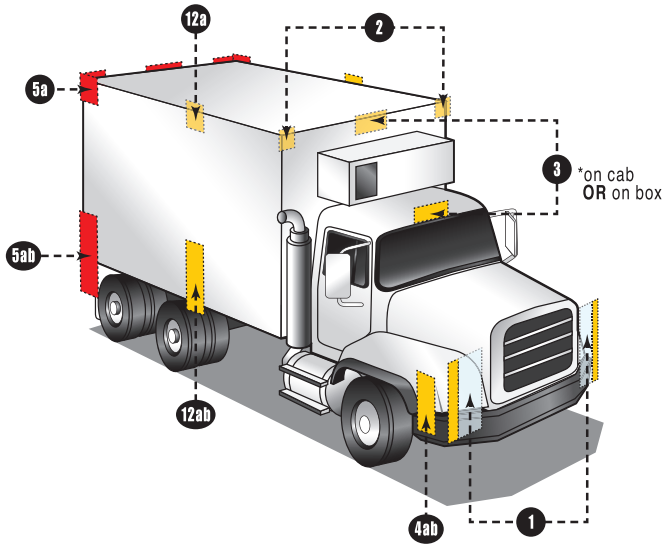

# FMVSS LIGHTING REQUIREMENTS – TRUCKS/BUSES/MPV'S

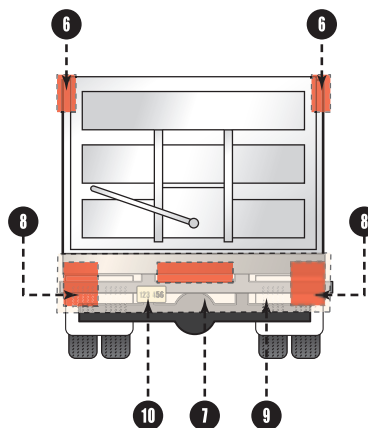
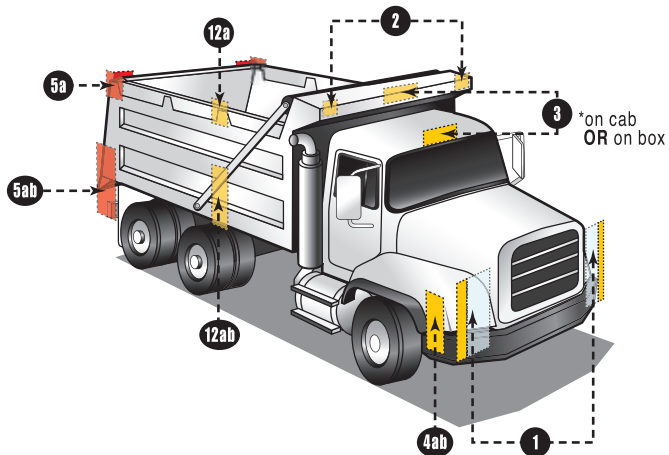
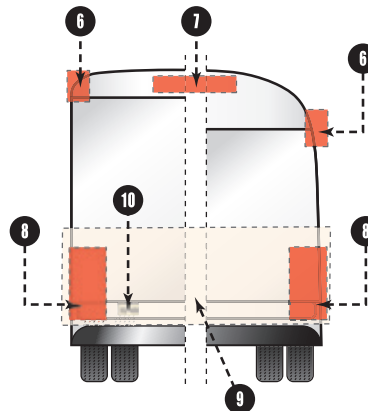
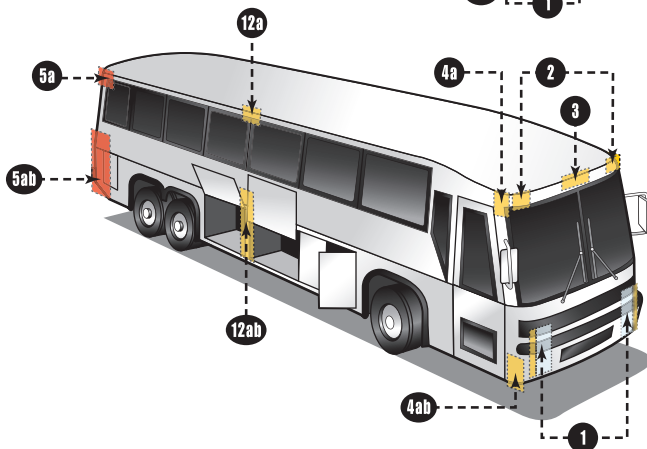
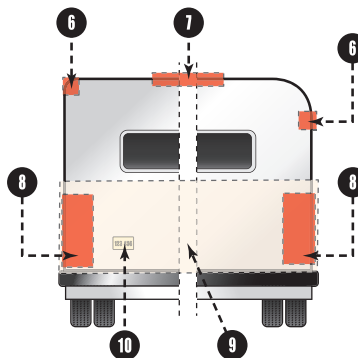
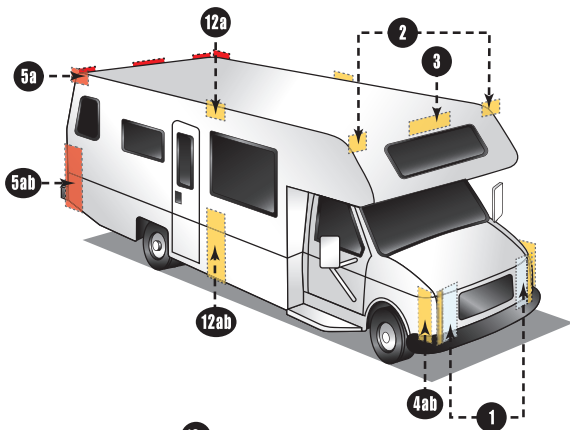
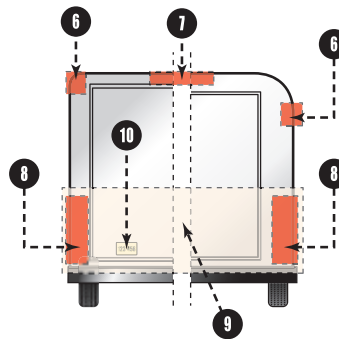
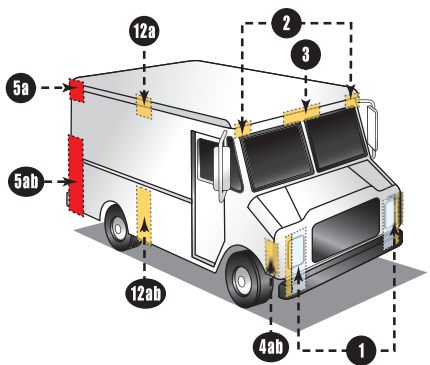



## Truck & Trailer Regulation – FMVSS 108 (49CFR 571.108)

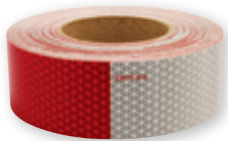
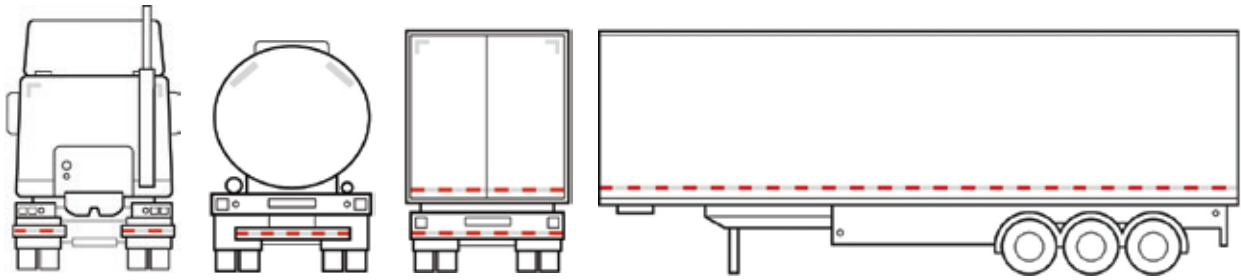

### APPLICATION LOCATIONS:

#### Rear Upper Body

12" WHITE strips placed in the upper rear corners

#### Rear Lower Body

- 2" wide RED/WHITE tape placed on rear full width of vehicle
- 2" wide RED/WHITE tape minimum 24" length on fender, mudflap brackets or within 12" below the top of mudflaps

#### Side Marking

2" wide RED/WHITE tape placed on each side of trailer continuous or evenly spaced over 50% of the vehicle

## School Bus Regulation – FMVSS 131 & 217

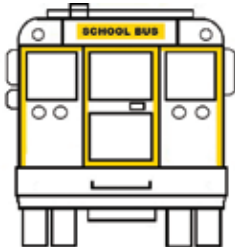

Each opening for a required emergency exit shall be outlined around its outside perimeter with a retroreflective tape with a minimum width of 1 inch and either red, white, or yellow in color, that when tested under the conditions specified in S6.1 of Standard No. 131 (49 CFR 571.131), meets the criteria specified.

### APPLICATION LOCATIONS:

- 1" strips used to mark side emergency exit windows
- 1" strips used to mark back emergency exit windows



00212005P .....189	00212351P .....189	06001048P .....256	11212709P .....75	357B .....259
00212011B .....189	00212355P .....76	06001061B .....256	11212710P .....75	357P .....259
00212031B .....189	00212356P .....76	06001061P .....256	11212711P .....75	3801071BZL .....255
00212031P .....189	00212357P .....76	06001072B .....256	13000018B .....261	3801071BZLP .....255
00212104B .....78	00212358P .....76	06001072P .....256	13000018P .....261	3802071BZL .....255
00212117B .....78	00212362B .....189	06002001B .....257	1502B .....262	3802071BZLP .....255
00212127P .....78	00212362P .....189	06002001P .....257	1502P .....262	500302B .....262
00212135P .....78	00212365P .....76	060102B .....257	15202B .....262	500302P .....262
00212137P .....78	00212367P .....76	060102P .....257	15202P .....262	510001B .....262
00212155P .....78	00212368P .....76	0601B .....257	16802B .....250	510001P .....262
00212157P .....78	00212376B .....76	0601P .....257	16802P .....250	530002B .....262
00212207B .....77	00212378B .....76	06300003B .....257	18543910B .....258	530002P .....262
00212209B .....77	00212386B .....76	06300003P .....257	18543916B .....258	69000201B .....260
00212213B .....77	00212700B .....79	06300004B .....257	18543916BP .....258	69000201P .....260
00212217B .....74	00212701B .....79	06300004P .....257	18543936B .....258	69000300B .....260
00212227P .....74	00212702B .....79	068NME.....250	19102B .....250	69000300P .....260
00212231B .....190	00212703B .....79	068NMEP .....250	19102P .....250	725022B .....255
00212231P .....190	00212704P .....79	068WMTE .....250	193BSP.....260	725022P .....255
00212233B .....190	00212705P .....79	068WMTEP .....250	193BSPP .....260	726022B .....255
00212233P .....190	00212706P .....79	09017101B .....262	193G .....260	726022P .....255
00212235P .....77	00212707P .....79	09017101P .....262	193P .....260	7850NFRC .....261
00212236P .....77	00212708P .....79	105500SP.....258	24004002B .....253	7850NFRC .....261
00212237P .....77	00212709P .....79	105520B .....258	240047171B .....253	825LED .....254
00212238P .....77	00212710P .....79	105520BP .....258	240047171LB.....253	825TR02.....254
00212239B .....190	00212711P .....79	11212207B .....74	240047171P .....253	825TR02P.....254
00212239P .....190	00212712P .....79	11212209B .....74	24004TR71 .....253	826L .....254
00212251B .....190	00212717B .....75	11212235P .....74	24004TR71P.....253	826LED .....254
00212251P .....190	00212727P .....75	11212236P .....74	240147171B .....253	826LED .....254
00212253B .....190	01180071B .....261	11212237P .....74	240147171LB.....253	826LP.....254
00212253P .....190	01180071P .....261	11212238P .....74	240147171P .....253	826TR02.....254
00212254P .....77	01180089B .....261	11212255P .....74	24014TR71 .....253	826TR02P.....254
00212255P .....77	01180089P .....261	11212256P .....74	24014TR71P.....253	826TR12.....254
00212256P .....77	01180090B .....261	11212257P .....74	24074B .....251	826TR12P.....254
00212257P .....77	01180090BP .....261	11212258P .....74	24074P .....251	826TR90.....254
00212258P .....77	014BCRCW .....261	11212276B .....74	2407764B .....251	A0116AWGBLWSB ..287
00212263P .....77	014BCRCWP.....261	11212278B .....74	2407764P .....251	A0118AWGBRGRSB 287
00212276B .....77	03001150B .....252	11212307B .....73	2407765B .....251	A0118AWGBRSB ..287
00212278B .....77	03001150P .....252	11212309B .....73	2407765P .....251	A0118AWGBRYLWSB287
00212307B .....76	03001175B .....252	11212335P .....73	2407771C.....251	A0118AWGWHTSB ..287
00212309B .....76	03001175P .....252	11212336P .....73	2407771CP .....251	A06TR .....278
00212316B .....76	04010040B .....252	11212337P .....73	2409171B .....262	A06TRP .....278
00212317B .....73	04010040P .....252	11212338P .....73	2409171BP .....262	A09BB.....278
00212327P .....73	06001001B .....257	11212355P .....73	24113160B .....259	A09BBP.....278
00212331B .....189	06001001P .....257	11212356P .....73	24113160P .....259	A09CB.....278
00212331P .....189	06001013B .....255	11212357P .....73	2500128B .....261	A09CBP.....278
00212333B .....189	06001013P .....255	11212358P .....73	2500128P .....261	A09WB .....278
00212333P .....189	06001014B .....255	11212376B .....73	2500171B .....261	A09WBP .....278
00212335P .....76	06001014P .....255	11212378B .....73	2500171P .....261	A101TRSSB .....274
00212336P .....76	06001015B .....256	11212700B .....75	2500189B .....261	A101TRSSBP .....274
00212337P .....76	06001015P .....256	11212701B .....75	2500189P .....261	A10BB.....267
00212338P .....76	06001022B .....253	11212702B .....75	30000000B .....262	A10BBP.....267
00212342B .....189	06001022P .....253	11212703B .....75	30031010B .....262	A10GB.....267
00212342P .....189	06001026B .....256	11212704P .....75	302B .....262	A10GBP.....267
00212345P .....76	06001026P .....256	11212705P .....75	302P .....262	A10TH5B.....285
00212346P .....76	06001037B .....256	11212706P .....75	30655010B .....262	A10TH5BP.....285
00212347P .....76	06001037P .....256	11212707P .....75	3202B .....262	A111TRSSB .....276
00212351B .....189	06001048B .....256	11212708P .....75	3202P .....262	A111TRSSBP .....276

A1157B.....	287	A194B.....	287	A36RB.....	203	A45SBP.....	273	A57WH.....	285
A1157BP.....	287	A194BP.....	287	A36RBP.....	203	A46GB.....	273	A58GB.....	269
A11AB.....	200	A2057B.....	287	A36WRB.....	286	A46GBP.....	273	A58GBP.....	269
A11ABP.....	200	A2057BP.....	287	A36WRBP.....	286	A46P135B.....	283	A5TRSSB.....	274
A11AXB.....	266	A20R.....	177	A37RB.....	183	A46P36B.....	283	A5TRSSBP.....	274
A11AXBP.....	266	A20WB.....	286	A37RBP.....	183	A46P75B.....	283	A60GB.....	275
A11BLPB.....	267	A20WBP.....	286	A38AB.....	204	A46PB.....	283	A60GBP.....	275
A11BLPBP.....	267	A21CHB.....	148	A38ABP.....	204	A46PBB.....	283	A60RB.....	185
A11DB.....	267	A21CHBP.....	148	A38RB.....	204	A46PBBP.....	283	A60RBP.....	185
A11DBP.....	267	A24RB.....	177	A38RBP.....	204	A46PBP.....	283	A65B.....	271
A11GB.....	267	A24RBP.....	177	A39RB.....	183	A46PPG.....	283	A65BP.....	271
A11GBP.....	267	A255WH.....	286	A39RBP.....	183	A46PPGP.....	283	A65P.....	284
A11GLPB.....	267	A25GB.....	288	A3TRSSB.....	268	A46PS.....	283	A65PB.....	271
A11GLPBP.....	267	A25GBP.....	288	A3TRSSBP.....	268	A47PB.....	281	A65PBP.....	271
A11PB.....	267	A25R10WB.....	286	A400.....	287	A47PBB.....	281	A65PBPG.....	271
A11PBP.....	267	A25R10WBP.....	286	A40RB.....	173	A47PBBP.....	281	A65PBPGP.....	271
A11RB.....	200	A25TRSSB.....	270	A40RBP.....	173	A47PBP.....	281	A65PP.....	284
A11RBP.....	200	A25TRSSBP.....	270	A40SRB.....	277	A47PS.....	281	A65PRXB.....	271
A11RXB.....	266	A25W42B.....	286	A40SRBP.....	277	A48CB.....	278	A65PRXBP.....	271
A11RXBP.....	266	A25W42BP.....	286	A40W42B.....	286	A48CBP.....	278	A65TB.....	271
A11SRB.....	80	A25W5B.....	286	A40W42BP.....	286	A48TC.....	285	A65TBP.....	271
A11SRBP.....	80	A25W5BP.....	286	A40W5B.....	286	A49PB.....	282	A66AB.....	207
A11SSB.....	267	A25WB.....	286	A40W5BP.....	286	A49PBB.....	282	A66ABP.....	207
A11SSBP.....	267	A25WBP.....	286	A42AB.....	205	A49PBBP.....	282	A66GB.....	288
A12B2LPB.....	267	A25WH.....	286	A42ABP.....	205	A49PBP.....	282	A66GBP.....	288
A12B2LPBP.....	267	A2RB.....	180	A42FCB.....	274	A4TC4WB.....	285	A66PB.....	271
A12GB.....	267	A2RBP.....	180	A42FCBP.....	274	A4TC4WBP.....	285	A66PBP.....	271
A12GBP.....	267	A30W10B.....	286	A42GB.....	288	A52AB.....	176	A66RB.....	207
A12GLPB.....	267	A30W10BP.....	286	A42GBP.....	288	A52ABP.....	176	A66RBP.....	207
A12GLPBP.....	267	A30W5B.....	286	A42PMB.....	282	A52GB.....	288	A67BB.....	271
A12PB.....	283	A30W5BLB.....	286	A42PMBP.....	282	A52GBP.....	288	A67BBP.....	271
A12PBP.....	283	A30W5BP.....	286	A42RB.....	205	A52RB.....	176	A67CB.....	271
A13B2B.....	278	A30WB.....	286	A42RBP.....	205	A52RBP.....	176	A67CBP.....	271
A13B2BP.....	278	A30WBP.....	286	A43RB.....	173	A53GB.....	268	A67CBPG.....	271
A13C2B.....	278	A31AB.....	202	A43RBP.....	173	A53GBP.....	268	A67CBPGP.....	271
A13C2BP.....	278	A31ABP.....	202	A44A500B.....	206	A54GB.....	268	A67CVB.....	271
A13G2B.....	288	A31RB.....	202	A44AB.....	206	A54GBP.....	268	A67CVBP.....	271
A13G2BP.....	288	A31RBP.....	202	A44ABP.....	206	A54GK.....	268	A67GB.....	271
A14GB.....	267	A32AB.....	202	A44GTB.....	288	A54GKP.....	268	A67GBP.....	271
A14GBP.....	267	A32ABP.....	202	A44GTBP.....	288	A55CB.....	268	A67P10G.....	271
A15BB.....	278	A32GB.....	288	A44R500B.....	206	A55CBP.....	268	A67P10GP.....	271
A15BBP.....	278	A32GBP.....	288	A44RB.....	206	A55GB.....	269	A68AB.....	208
A15CB.....	278	A32RBP.....	202	A44RBP.....	206	A55GBP.....	269	A68ABP.....	208
A15CBP.....	278	A32RB.....	202	A45BB.....	273	A55GK.....	269	A68P.....	284
A15GB.....	288	A33GB.....	277	A45BBP.....	273	A55GKP.....	269	A68PB.....	271
A15GBP.....	288	A33GBP.....	277	A45CB.....	282	A55GWB.....	269	A68PBP.....	271
A16R.....	182	A35R10WB.....	286	A45CBP.....	282	A55GWBP.....	269	A68PP.....	284
A16RB.....	182	A35R10WBP.....	286	A45CGB.....	274	A56GB.....	269	A68RB.....	208
A16RBP.....	182	A35W42B.....	286	A45CGBP.....	274	A56GBP.....	269	A68RBP.....	208
A178TRSSB.....	276	A35W42BP.....	286	A45GB.....	273	A57CB.....	270	A68SSB.....	278
A178TRSSBP.....	276	A35W5B.....	286	A45GBP.....	273	A57CBP.....	270	A68SSBP.....	278
A17GB.....	288	A35W5BP.....	286	A45PB.....	281	A57GB.....	269	A69CB.....	278
A17GBP.....	288	A35WB.....	286	A45PBP.....	281	A57GBP.....	269	A69CBP.....	278
A17RB.....	182	A35WBP.....	286	A45PMB.....	281	A57GK.....	269	A69GB.....	288
A17RBP.....	182	A36AB.....	203	A45PMBP.....	281	A57GKP.....	269	A69GBP.....	288
A185TC.....	285	A36ABP.....	203	A45PS.....	281	A57WB.....	285	A69RXC.....	278
A18TC.....	285	A36R.....	183	A45SBP.....	273	A57WBP.....	285	A69RXCBP.....	278

A6TC4WB.....	285	A91LRW.....	284	ALEDFS.....	288	BU44CB.....	188	BUL12CKBP.....	66
A6TC4WBP.....	285	A91LRWP.....	284	ALEDRST1B.....	287	BU44CBP.....	188	BUL12CSB.....	66
A700.....	287	A91LW.....	284	ALEDRST1BP.....	287	BU45CB.....	188	BUL12CSBP.....	66
A70GB.....	275	A91LWP.....	284	ALEDRST2B.....	287	BU45CBP.....	188	BUL13CB.....	138
A70GBD.....	275	A91OB.....	272	ALEDRST2BP.....	287	BU49CB.....	188	BUL13CBP.....	138
A70GBDP.....	275	A91OBP.....	272	APL1AB.....	241	BU49CBP.....	188	BUL22CB.....	68
A70GBP.....	275	A91RB.....	199	APL1ABP.....	241	BU64CB.....	188	BUL22CBP.....	68
A71CBAWN.....	278	A91RBP.....	199	APL1CB.....	241	BU64CBP.....	188	BUL23C24B.....	64
A71CBAWNP.....	278	A921B.....	287	APL1CBP.....	241	BU65CB.....	188	BUL23C24BP.....	64
A73GB.....	288	A921BP.....	287	APL5AB.....	242	BU65CBP.....	188	BUL23CB.....	64
A73GBP.....	288	A93PB.....	283	APL5ABP.....	242	BU70CB.....	188	BUL23CBP.....	64
A75TB.....	285	A93PBP.....	283	APL5CB.....	242	BU70CBP.....	188	BUL28CLPB.....	140
A75TBP.....	285	A94VB.....	278	APL5CBP.....	242	BU74CB.....	188	BUL28CLPBP.....	140
A75TC.....	285	A94VBP.....	278	ARVIL35B.....	247	BU74CBP.....	188	BUL35CB.....	69
A77SB.....	275	A9R.....	178	ARVIL35BP.....	247	BUL002CB.....	67	BUL35CBP.....	69
A77SBP.....	275	A9RB.....	178	AST50B.....	237	BUL002CBP.....	67	BUL43CB.....	138
A78CB1.....	276	A9RBP.....	178	AST50BP.....	237	BUL002CM3B.....	67	BUL43CBK.....	138
A78CB1P.....	276	A9RBP.....	178	AST51B.....	237	BUL002CM3BP.....	67	BUL43CBKP.....	138
A78RXB.....	276	A9RBP.....	178	AST51BP.....	237	BUL003CB.....	62	BUL43CBP.....	138
A78RXBP.....	276	A9RBP.....	178	AST60B.....	235	BUL003CBP.....	62	BUL52CB.....	68
A79CB.....	278	A9RBP.....	178	AST60BP.....	235	BUL003CKB.....	62	BUL52CBP.....	68
A7TRSSB.....	276	A9RBP.....	178	AST61B.....	235	BUL003CKBP.....	62	BUL53CB.....	64
A7TRSSBP.....	276	A9RBP.....	178	AST61BP.....	235	BUL06CB.....	61	BUL53CBP.....	64
A7WCB.....	285	A9RBP.....	178	BA44FNL.....	206	BUL06CBP.....	61	BUL53CKB.....	64
A7WCBP.....	285	A9RBP.....	178	BA44FNLP.....	206	BUL06CFB.....	61	BUL53CKBP.....	64
A82AB.....	210	A9RBP.....	178	BA44FNR.....	206	BUL06CFBP.....	61	BUL69CB.....	139
A82ABP.....	210	A9RBP.....	178	BA44FNRP.....	206	BUL06CFMB.....	61	BUL69CBMVC2B.....	139
A82RB.....	210	A9RBP.....	178	BA65ARLB.....	197	BUL06CFMBP.....	61	BUL69CBMVC2BP.....	139
A82RBP.....	210	A9RBP.....	178	BA65ARLBP.....	197	BUL06CKB.....	61	BUL69CBP.....	139
A830B.....	288	A9RBP.....	178	BA65ARRB.....	197	BUL06CKBP.....	61	BUL69CPG.....	139
A839B.....	288	A9RBP.....	178	BA65ARRBP.....	197	BUL06CMB.....	61	BUL69CPGP.....	139
A86PB.....	283	A9RBP.....	178	BK31BB.....	279	BUL06CMBP.....	61	BUL72CB.....	139
A86PBP.....	283	A9RBP.....	178	BK31BBP.....	279	BUL101CB.....	60	BUL72CBGK.....	139
A8R.....	178	A9RBP.....	178	BK42CB.....	277	BUL101CBP.....	60	BUL72CBGKP.....	139
A8RB.....	178	A9RBP.....	178	BK42CBP.....	277	BUL101CKB.....	60	BUL72CBP.....	139
A8RBP.....	178	A9RBP.....	178	BK45BB.....	273	BUL101CKBP.....	60	BUL73CB.....	140
A8RK.....	178	A9RBP.....	178	BK45BBP.....	273	BUL10CB.....	68	BUL73CBP.....	140
A90AB.....	174	A9RBP.....	178	BK53BB.....	268	BUL10CBP.....	68	BUL74CBK.....	139
A90ABP.....	174	A9RBP.....	178	BK53BBP.....	268	BUL10CMB.....	68	BUL74CBKP.....	139
A90RB.....	174	A9RBP.....	178	BK5557GB.....	268	BUL10CMBP.....	68	BUL78C3MB.....	140
A90RBP.....	174	A9RBP.....	178	BK5557GBP.....	268	BUL111CB.....	65	BUL78C3MBP.....	140
A91AB.....	199	A9RBP.....	178	BK5557G.....	268	BUL111CBP.....	65	BUL78CB.....	140
A91ABP.....	199	A9RBP.....	178	BK55BB.....	270	BUL11CB.....	63	BUL78CBP.....	140
A91BB.....	272	A9RBP.....	178	BK55BBP.....	270	BUL11CBP.....	63	BUL78CEZB.....	140
A91BBP.....	272	A9RBP.....	178	BK57BB.....	270	BUL11CBP.....	63	BUL78CEZBP.....	140
A91BOB.....	272	A9RBP.....	178	BK57BBP.....	270	BUL11CBX.....	63	BUL90C24B.....	69
A91BOBP.....	272	A9RBP.....	178	BK61AB.....	196	BUL11CBXP.....	63	BUL90C24BP.....	69
A91CB.....	272	A9RBP.....	178	BK66DB.....	277	BUL11CKB.....	63	BUL90CB.....	69
A91CBP.....	272	A9RBP.....	178	BK66DBP.....	277	BUL11CKBP.....	63	BUL90CBP.....	69
A91G15B1.....	272	A9RBP.....	178	BK70BB.....	275	BUL11CM24B.....	63	BUL90CBP.....	69
A91G15B1P.....	272	A9RBP.....	178	BK70BBP.....	275	BUL11CM24BP.....	63	CB11AS.....	212
A91GB.....	272	A9RBP.....	178	BU11CS.....	187	BUL11CMB.....	63	CB11WAB.....	212
A91GBP.....	272	A9RBP.....	178	BU33CRX24LB.....	188	BUL11CMBP.....	63	CB11WABP.....	212
A91GOB.....	272	A9RBP.....	178	BU33CRX24LBP.....	188	BUL12CB.....	66	CB15AK.....	212
A91GOBP.....	272	A9RBP.....	178	BU33CRXLB.....	188	BUL12CBP.....	66	CB20AB.....	213
A91GZB.....	272	A9RBP.....	178	BU33CRXLBP.....	188	BUL12CFB.....	66	CB20ABP.....	213
A91GZBP.....	272	A9RBP.....	178	BU41CB.....	187	BUL12CFBP.....	66	CB20AS.....	213
		A9RBP.....	178	BU41CBP.....	187	BUL12CKB.....	66	CB22AB.....	213

CB22ABP.....213	ILL22CBP ..... 150	ILL72CB ..... 154	LP54CBP.....220	LPL43CBP .....135
CB22AS .....213	ILL22CHB ..... 150	ILL72CBP ..... 154	LP55CB.....220	LPL55CB .....135
CB22RB .....213	ILL22CHBP ..... 150	ILL85CB ..... 155	LP55CBP.....220	LPL55CBP .....135
CB22RBP .....213	ILL24CB ..... 150	ILL85CBP ..... 155	LP56CB.....221	LPL55CKB .....135
CBL22AB .....126	ILL24CBP ..... 150	ILL86BCB ..... 155	LP56CBP.....221	LPL55CKBP .....135
CBL22ABP .....126	ILL25CB ..... 149	ILL86BCBP ..... 155	LP5SB .....279	LPL55CPG .....135
CBL22AS .....126	ILL25CBP ..... 149	ILL86CB ..... 155	LP5SBP .....279	LPL55CPGP .....135
CBL22CAB .....126	ILL26CB ..... 149	ILL86CBP ..... 155	LP65CB.....221	LPL56CB .....135
CBL22CABP .....126	ILL26CBP ..... 149	ILL91CB ..... 156	LP65CBP.....221	LPL56CBP .....135
CBL22RB.....126	ILL28CMB ..... 147	ILL91CBP ..... 156	LP71CB.....222	LPL61C24B .....136
CBL22RBP .....126	ILL28CMBP ..... 147	ILL91CPG ..... 156	LP71CBP.....222	LPL61C24BP .....136
DH55 .....280	ILL28CMPG ..... 147	ILL91CPGP ..... 156	LP71CS .....222	LPL65CB .....136
DH55P .....280	ILL28CMPGP ..... 147	LM112CB.....156	LP81BB.....222	LPL65CBP .....136
DL16CC .....232	ILL30CBB ..... 151	LM112CBP ..... 156	LP81BBP .....222	LPL91CAB .....137
DL16WC.....232	ILL30CBBP ..... 151	LM315BB ..... 156	LP81BPG .....222	LPL91CABP .....137
DL55CS .....232	ILL31CB ..... 151	LM315BBP ..... 156	LP81GB.....222	LPL91CB .....137
DLL50CB.....168	ILL31CBP ..... 151	LM835CB.....156	LP85CB.....224	LPL91CBKB .....137
DLL50CBP .....168	ILL32CB ..... 151	LM835CBP ..... 156	LP85CBP.....224	LPL91CBKBP .....137
DLL50CC.....168	ILL32CBP ..... 151	LP10S.....279	LP91CB.....224	LPL91CBP .....137
DLL50WC .....168	ILL32CPG ..... 151	LP10SB .....279	LP91CBP.....224	LPL91CKALPB .....137
HLL88LB .....2	ILL33CB ..... 152	LP10SBP .....279	LP95CBF .....223	LPL91CKALPBP .....137
HLL88LBP .....2	ILL33CBP ..... 152	LP11CB.....217	LP97CB.....223	LPL91CKB .....137
HLL89HB .....2	ILL35CB ..... 151	LP11CBP.....217	LP97CBP.....223	LPL91CKBP .....137
HLL89HBP .....2	ILL36CB ..... 152	LP11CPG.....217	LPB31CPG .....218	LPL91CPG .....137
HLL90HLB.....3	ILL36CBP ..... 152	LP11CPGP .....217	LPB31CPGP .....218	LPL91CPGP .....137
HLL90HLBP .....3	ILL36CPG ..... 152	LP11CS .....217	LPL11CB .....132	MC11AB.....200
IL21CB .....228	ILL36CPGP ..... 152	LP15S.....279	LPL11CBP .....132	MC11ABP .....200
IL21CBP .....228	ILL39CB ..... 148	LP15SB.....279	LPL12CB .....133	MC11AK .....200
IL21CPG .....228	ILL39CBP ..... 148	LP15SBP .....279	LPL12CBP .....133	MC11AS.....200
IL21CS .....228	ILL45CB ..... 153	LP20SB .....279	LPL12CKF2B .....133	MC11RB .....200
IL22CB .....228	ILL45CBP ..... 153	LP20SBP .....279	LPL12CKF2BP .....133	MC11RBP .....200
IL22CBP .....228	ILL46CB ..... 153	LP21CB.....217	LPL12CKM2B.....133	MC11RS .....200
IL31CS .....228	ILL46CBP ..... 153	LP21CBP.....217	LPL12CKM2BP .....133	MC21AS.....201
IL41CB .....229	ILL70ABAWN.....239	LP21CS .....217	LPL12CKM5B.....133	MC21RS .....201
IL41CBP .....229	ILL70ABAWN .....239	LP25SB .....280	LPL12CKM5BP .....133	MC22AB.....201
IL61CB .....229	ILL70ABBAWN.....239	LP25SBP .....280	LPL12CKMB.....133	MC22ABP .....201
IL61CBP .....229	ILL70ABBAWN .....239	LP26SKB.....224	LPL12CKMBP .....133	MC22RB .....201
IL91CB .....230	ILL70CB ..... 154	LP26SKBP.....224	LPL12CPGB.....133	MC22RBP .....201
IL91CBP .....230	ILL70CBAWN.....239	LP31CB.....218	LPL12CPGBP.....133	MC25AB.....191
ILL01RB .....146	ILL70CBAWN .....239	LP31CBP.....218	LPL21CB .....134	MC25ABP .....191
ILL01RBP .....146	ILL70CBBAWN .....239	LP31CPG.....218	LPL21CBP .....134	MC25RB .....191
ILL06COB .....146	ILL70CBBAWN .....239	LP31CPGP .....218	LPL26SKB .....137	MC25RBP .....191
ILL06COBP .....146	ILL70CBP ..... 154	LP31CS .....218	LPL26SKBP .....137	MC27AB.....191
ILL06COPG .....146	ILL70CBSAWN.....239	LP31SB .....279	LPL31CB .....134	MC27ABP .....191
ILL06COPGP .....146	ILL70CBSAWN .....239	LP31SBP .....279	LPL31CBP .....134	MC27RB .....191
ILL07COB .....146	ILL70CCSAWN .....239	LP35BB.....280	LPL31CEZB .....134	MC27RBP .....191
ILL07COBP .....146	ILL70CCSAWN .....239	LP35BBP .....280	LPL31CEZBP .....134	MC30AB.....200
ILL08COB .....147	ILL70CSB.....154	LP41CB.....219	LPL31CPG .....134	MC30ABP .....200
ILL08COBP .....147	ILL70CSBP ..... 154	LP41CBP.....219	LPL31CPGP .....134	MC31A15B2.....202
ILL08COPG .....147	ILL71CB ..... 154	LP41CS .....219	LPL31CS .....134	MC31AB.....202
ILL08COPGP .....147	ILL71CBAWN.....239	LP51CB.....219	LPL31CSB .....134	MC31ABP .....202
ILL10CCB .....147	ILL71CBAWN .....239	LP51CBP.....219	LPL31CSBP .....134	MC31AS.....202
ILL10CCBP .....147	ILL71CBP ..... 154	LP52CB.....220	LPL41CB .....135	MC31R15B2.....202
ILL21CB .....148	ILL71CPG ..... 154	LP52CBP.....220	LPL41CBP .....135	MC31RB .....202
ILL21CBP .....148	ILL71CPGP ..... 154	LP52HP .....220	LPL42CBF .....135	MC31RBP .....202
ILL21CTPB.....148	ILL71CSB.....154	LP52HPP .....220	LPL42CBFP .....135	MC31RS .....202
ILL22CB .....150	ILL71CSBP ..... 154	LP54CB.....220	LPL43CB .....135	MC32AB.....202

MC32ABB .....202	MC52AXBP .....192	MC66RBP .....207	MC93RPG .....214	MCL111RBP .....82
MC32ABBP .....202	MC52RB .....192	MC66RS .....207	MC93RPGP .....214	MCL111RKB .....82
MC32ABP .....202	MC52RBP .....192	MC67AB .....198	MC94RB .....215	MCL111RKBP .....82
MC32ABS .....202	MC52RXB .....192	MC67ABP .....198	MC94RBP .....215	MCL111RKFPFG .....82
MC32AS .....202	MC52RXBP .....192	MC67AK .....198	MC95AB .....211	MCL111RKFPGP .....82
MC32RB .....202	MC53AB .....193	MC67ARB .....197	MC95ABP .....211	MCL111RKPG .....82
MC32RBB .....202	MC53ABP .....193	MC67ARBP .....197	MC95APG .....211	MCL111RKPGP .....82
MC32RBBP .....202	MC53ABSB .....193	MC67RB .....198	MC95AS .....211	MCL112AB .....83
MC32RBP .....202	MC53ABSBP .....193	MC67RBP .....198	MC95RB .....211	MCL112ABP .....83
MC32RBS .....202	MC53AKB .....193	MC67RK .....198	MC95RBP .....211	MCL112AKB .....83
MC32RS .....202	MC53AKBP .....193	MC68AB .....208	MC95RS .....211	MCL112AKBP .....83
MC35AB .....203	MC53AS .....193	MC68ABP .....208	MC97R70PG .....215	MCL112RB .....83
MC35ABP .....203	MC53RB .....193	MC68AS .....208	MC97RB .....215	MCL112RBP .....83
MC35AEB .....203	MC53RBP .....193	MC68RB .....208	MC97RBP .....215	MCL112RKB .....83
MC35AEBP .....203	MC53RKB .....193	MC68RBP .....208	MC97RK .....215	MCL112RKBP .....83
MC35AS .....203	MC53RKBP .....193	MC68RS .....208	MC97RTTG .....215	MCL11A24KB .....85
MC36AB .....203	MC53RS .....193	MC70AB .....208	MC99AB .....216	MCL11AB .....85
MC36ABP .....203	MC54AB .....193	MC70ABP .....208	MC99ABP .....216	MCL11ABP .....85
MC36AS .....203	MC54ABP .....193	MC70RB .....208	MC99AK .....216	MCL11AHPG .....85
MC36RB .....203	MC54RB .....193	MC70RBP .....208	MC99RB .....216	MCL11AK12B .....85
MC36RBP .....203	MC54RBP .....193	MC71AS .....209	MC99RBP .....216	MCL11AK12PG .....85
MC36RS .....203	MC55AB .....194	MC71RS .....209	MC99RK .....216	MCL11AKAB .....85
MC37AB .....204	MC55ABP .....194	MC76AB .....209	MCL10AB .....84	MCL11AKABP .....85
MC37ABP .....204	MC55RB .....194	MC76ABP .....209	MCL10ABP .....84	MCL11AKB .....85
MC38AB .....204	MC55RBP .....194	MC77RB .....214	MCL10AKB .....84	MCL11AKBF .....85
MC38ABP .....204	MC56AB .....195	MC77RBP .....214	MCL10AKBP .....84	MCL11AKBFP .....85
MC38RB .....204	MC56ABP .....195	MC81AB .....210	MCL10CAK14B .....84	MCL11AKBP .....85
MC38RBP .....204	MC56RB .....195	MC81ABP .....210	MCL10CAK14BP .....84	MCL11AKBSSP .....85
MC42AB .....205	MC56RBP .....195	MC81AS .....210	MCL10CRK14B .....84	MCL11AKPV4G .....85
MC42ABP .....205	MC57AB .....194	MC81RB .....210	MCL10CRK14BP .....84	MCL11AKPVG .....85
MC42AS .....205	MC57ABP .....194	MC81RBP .....210	MCL10RB .....84	MCL11APG .....85
MC42RB .....205	MC57AS .....194	MC81RS .....210	MCL10RBP .....84	MCL11APGP .....85
MC42RBP .....205	MC57RB .....194	MC82AB .....210	MCL10RKB .....84	MCL11CAB .....85
MC42RS .....205	MC57RBP .....194	MC82ABP .....210	MCL10RKBP .....84	MCL11CABP .....85
MC441WB .....206	MC57RS .....194	MC82RB .....210	MCL110AB .....81	MCL11CAKB .....85
MC442WB .....206	MC58AS .....207	MC82RBP .....210	MCL110ABP .....81	MCL11CAKBF .....85
MC44AB .....206	MC58RB .....207	MC85AB .....211	MCL110AKB .....81	MCL11CAKBP .....85
MC44AB1 .....206	MC58RBP .....207	MC85ABP .....211	MCL110AKBF .....81	MCL11CAKPG .....85
MC44AB1P .....206	MC58RS .....207	MC90AS .....199	MCL110AKBFP .....81	MCL11CRB .....85
MC44ABP .....206	MC59AFB .....195	MC90RS .....199	MCL110AKBP .....81	MCL11CRBP .....85
MC44AS .....206	MC59AFBP .....195	MC91AB .....199	MCL110AKPG .....81	MCL11CRKB .....85
MC44RB .....206	MC59RFB .....195	MC91ABP .....199	MCL110AKPGP .....81	MCL11CRKBF .....85
MC44RB1 .....206	MC59RFBP .....195	MC91AS .....199	MCL110RB .....81	MCL11CRKBP .....85
MC44RB1P .....206	MC61ABKB .....196	MC91RS .....199	MCL110RBP .....81	MCL11CRKPG .....85
MC44RBP .....206	MC61ABKBP .....196	MC92AB .....199	MCL110RKB .....81	MCL11R24KB .....85
MC44RS .....206	MC65AB .....198	MC92ABP .....199	MCL110RKBFP .....81	MCL11RB .....85
MC48AB .....205	MC65ABP .....198	MC92AS .....199	MCL110RKBFP .....81	MCL11RBP .....85
MC48ABP .....205	MC65ARB .....197	MC92RB .....199	MCL110RKBP .....81	MCL11RHPG .....85
MC48APG .....205	MC65ARBP .....197	MC92RBP .....199	MCL110RKPG .....81	MCL11RK12B .....85
MC48APGP .....205	MC65RB .....198	MC92RS .....199	MCL110RKPGP .....81	MCL11RK12PG .....85
MC48RPG .....205	MC65RBP .....198	MC93AB .....214	MCL111AB .....82	MCL11RKAB .....85
MC48RPGP .....205	MC66AB .....207	MC93ABP .....214	MCL111ABP .....82	MCL11RKB .....85
MC505ABSB .....193	MC66ABP .....207	MC93R2PG .....214	MCL111AKB .....82	MCL11RKBFP .....85
MC505ABSBP .....193	MC66AS .....207	MC93R2PGP .....214	MCL111AKBP .....82	MCL11RKBFP .....85
MC52AB .....192	MC66HAB .....207	MC93RB .....214	MCL111AKPG .....82	MCL11RKBP .....85
MC52ABP .....192	MC66HABP .....207	MC93RBP .....214	MCL111AKPGP .....82	MCL11RKBSSP .....85
MC52AXB .....192	MC66RB .....207	MC93RK .....214	MCL111RB .....82	MCL11RKPV4G .....85

MCL11RKPVG .....85	MCL13APGP.....112	MCL15RKPG .....114	MCL31RB .....117	MCL49AB.....120
MCL11RPG .....85	MCL13AS .....112	MCL15RKPGP .....114	MCL31RBP .....117	MCL49ABP .....120
MCL11RPGP .....85	MCL13ATRS .....112	MCL15RPG .....114	MCL32AB .....117	MCL505ABSB .....91
MCL11SAB .....80	MCL13CA2B .....112	MCL15RPGP .....114	MCL32ABB .....117	MCL505ABSBP .....91
MCL11SABP .....80	MCL13CA2BP .....112	MCL165AB .....105	MCL32ABBP .....117	MCL505GABSB .....91
MCL11SAK1B .....80	MCL13CA3B .....112	MCL165ABP .....105	MCL32ABP .....117	MCL505GABSBP .....91
MCL11SAK1BP .....80	MCL13CA3BP .....112	MCL165RB .....105	MCL32ABS .....117	MCL50AB .....94
MCL11SAKB .....80	MCL13CR2B .....112	MCL165RBP .....105	MCL32AS .....117	MCL50ABP .....94
MCL11SAKBP .....80	MCL13CR2BP .....112	MCL166AB .....122	MCL32RB .....117	MCL50RB .....94
MCL11SRB .....80	MCL13CR3B .....112	MCL166ABP .....122	MCL32RBB .....117	MCL50RBP .....94
MCL11SRBP .....80	MCL13CR3BP .....112	MCL166RB .....122	MCL32RBBP .....117	MCL51AB .....99
MCL11SRK1B .....80	MCL13R2B .....112	MCL166RBP .....122	MCL32RBP .....117	MCL51ABP .....99
MCL11SRK1BP .....80	MCL13R2BP .....112	MCL17AB .....116	MCL32RBS .....117	MCL51RB .....99
MCL11SRKB .....80	MCL13R2MB .....112	MCL17ABP .....116	MCL32RS .....117	MCL51RBP .....99
MCL11SRKBP .....80	MCL13R2MBP .....112	MCL17APG .....116	MCL35A32G .....118	MCL527AB .....98
MCL121AK9PVG .....82	MCL13R2PG .....112	MCL17APGP .....116	MCL35A32GP .....118	MCL527ABP .....98
MCL121AK9PVP .....82	MCL13R2PGP .....112	MCL17CAB .....116	MCL36AB .....118	MCL527AFB .....98
MCL121RK9PVG .....82	MCL13RS .....112	MCL17CABP .....116	MCL36ABP .....118	MCL527AFBP .....98
MCL121RK9PVP .....82	MCL13RTRS .....112	MCL17CRB .....116	MCL36APG .....118	MCL527AK .....98
MCL12AB .....86	MCL14A12GB .....113	MCL17CRBP .....116	MCL36APGP .....118	MCL527AS .....98
MCL12ABP .....86	MCL14A12GBP .....113	MCL17RB .....116	MCL36AS .....118	MCL527RB .....98
MCL12AK .....86	MCL14AB .....113	MCL17RBP .....116	MCL36RB .....118	MCL527RBP .....98
MCL12AK156PG .....86	MCL14ABF .....113	MCL17RPG .....116	MCL36RBP .....118	MCL527RFB .....98
MCL12AKB .....86	MCL14ABFP .....113	MCL17RPGP .....116	MCL40AB .....119	MCL527RFBP .....98
MCL12AKBP .....86	MCL14ABP .....113	MCL180ARB .....110	MCL40AB1 .....119	MCL527RK .....98
MCL12AKPG .....86	MCL14AGB .....113	MCL180ARBP .....110	MCL40AB1P .....119	MCL527RS .....98
MCL12ARLB .....87	MCL14AGBP .....113	MCL190AB .....102	MCL40ABP .....119	MCL52AB .....95
MCL12ARLBP .....87	MCL14AGPB .....113	MCL190ABP .....102	MCL40APB .....119	MCL52ABP .....95
MCL12ARRB .....87	MCL14AGPBP .....113	MCL190RB .....102	MCL40APBP .....119	MCL52AHXB .....93
MCL12ARRBP .....87	MCL14CABF .....113	MCL190RBP .....102	MCL40AS .....119	MCL52AHXBP .....93
MCL12CA2RLB .....87	MCL14CABFP .....113	MCL192RB .....131	MCL40RB .....119	MCL52AMB .....95
MCL12CA2RRB .....87	MCL14CRBF .....113	MCL192RBP .....131	MCL40RB1 .....119	MCL52AMB .....95
MCL12RB .....86	MCL14CRBFP .....113	MCL19AB .....116	MCL40RB1P .....119	MCL52RB .....95
MCL12RBP .....86	MCL14RB .....113	MCL19ABP .....116	MCL40RBP .....119	MCL52RBP .....95
MCL12RK .....86	MCL14RBF .....113	MCL19CAB .....116	MCL40RS .....119	MCL52RHXB .....93
MCL12RK156PG .....86	MCL14RBF .....113	MCL19CABP .....116	MCL44AB .....119	MCL52RHXBP .....93
MCL12RK3B .....131	MCL14RBP .....113	MCL19CRB .....116	MCL44AB1 .....119	MCL52RMB .....95
MCL12RK3BP .....131	MCL14RGB .....113	MCL19CRBP .....116	MCL44AB1P .....119	MCL52RMBP .....95
MCL12RK3RMB .....131	MCL14RGBP .....113	MCL19RB .....116	MCL44ABP .....119	MCL54AB .....95
MCL12RKB .....86	MCL14RPG .....113	MCL19RBP .....116	MCL44RB .....119	MCL54ABP .....95
MCL12RKB .....86	MCL14RPGP .....113	MCL21AB .....88	MCL44RB1 .....119	MCL54RB .....95
MCL12RKB .....86	MCL155AB .....89	MCL21ABP .....88	MCL44RB1P .....119	MCL54RBP .....95
MCL12RKB .....86	MCL155ABP .....89	MCL21RB .....88	MCL44RBP .....119	MCL55A1224B .....90
MCL12RKB .....86	MCL155ABP .....89	MCL21RBP .....88	MCL45AB .....120	MCL55A1224BP .....90
MCL12RKB .....86	MCL155AFB .....89	MCL21RKPV4G .....85	MCL45ABP .....120	MCL55AB .....90
MCL12RKB .....86	MCL155AFBP .....89	MCL22RK3B .....131	MCL45RB .....120	MCL55ABP .....90
MCL12RKB .....86	MCL155RFB .....89	MCL22RK4B .....131	MCL45RBP .....120	MCL55ACB .....90
MCL12RKB .....86	MCL155RFB .....89	MCL23AB .....88	MCL46AB .....120	MCL55ACBP .....90
MCL12RKB .....86	MCL155RFB .....89	MCL23ABP .....88	MCL46ABP .....120	MCL55AK .....90
MCL12RKB .....86	MCL155RFB .....89	MCL23ABP .....88	MCL46ABP .....120	MCL55AKB .....90
MCL12RKB .....86	MCL155RFB .....89	MCL23RB .....88	MCL46RBP .....120	MCL55AKBP .....90
MCL12RKB .....86	MCL155RFB .....89	MCL23RBP .....88	MCL48AB .....121	MCL55FRB .....90
MCL12RKB .....86	MCL155RFB .....89	MCL299AB .....115	MCL48ABP .....121	MCL55FRBP .....90
MCL12RKB .....86	MCL155RFB .....89	MCL299ABP .....115	MCL48AKB .....121	MCL55R1224B .....90
MCL12RKB .....86	MCL155RFB .....89	MCL299RB .....115	MCL48AKBP .....121	MCL55R1224BP .....90
MCL12RKB .....86	MCL155RFB .....89	MCL299RBP .....115	MCL48CAB .....121	MCL55RB .....90
MCL12RKB .....86	MCL155RFB .....89	MCL31AB .....117	MCL48CABP .....121	MCL55RBP .....90
MCL12RKB .....86	MCL155RFB .....89	MCL31ABP .....117		

MCL55RCB .....90	MCL61ARB .....109	MCL70RBP .....127	MCL93RPGP .....128	RE13AB.....266
MCL55RCBP .....90	MCL61AS .....107	MCL70RCB .....127	MCL95AB .....125	RE13ABP.....266
MCL55RK .....90	MCL61RB .....107	MCL70RCBP .....127	MCL95ABF .....125	RE13RB .....266
MCL55RKB .....90	MCL61RBP .....107	MCL70RS.....127	MCL95ABFP .....125	RE13RBP .....266
MCL55RKBP .....90	MCL61RK .....107	MCL71RB .....123	MCL95ABP .....125	RE15AB.....265
MCL56AB .....92	MCL61RS.....107	MCL71RBP .....123	MCL95AS .....125	RE15ABP.....265
MCL56ABP .....92	MCL63AB .....108	MCL73AB .....121	MCL95RB .....125	RE15AK.....265
MCL56AFB .....92	MCL63ABP .....108	MCL73ABP .....121	MCL95RBF .....125	RE15RB .....265
MCL56AFBP .....92	MCL63CAB .....108	MCL73RB .....121	MCL95RBF .....125	RE15RBP .....265
MCL56AK .....92	MCL63CABP .....108	MCL73RBP .....121	MCL95RBP .....125	RE15RK .....265
MCL56AS .....92	MCL63CRB .....108	MCL75AB .....106	MCL95RS.....125	RE18T.....263
MCL56RB .....92	MCL63CRBP .....108	MCL75ABP .....106	MCL96AB .....103	RE2018T.....263
MCL56RBP .....92	MCL63RB .....108	MCL75RB .....106	MCL96ABP .....103	RE21AB.....266
MCL56RFB.....92	MCL63RBP .....108	MCL75RBP .....106	MCL96RB .....103	RE21ABP.....266
MCL56RFBP .....92	MCL65A24B .....106	MCL76AB .....123	MCL96RBP .....103	RE21AS .....266
MCL56RK .....92	MCL65A24BP .....106	MCL76ABP .....123	MCL97RB .....129	RE21RB .....266
MCL56RS.....92	MCL65AB .....106	MCL76RB .....123	MCL97RBP .....129	RE21RBP .....266
MCL57A24B .....97	MCL65ABP .....106	MCL76RBP .....123	MCL97RK .....129	RE21RS .....266
MCL57A24BP .....97	MCL65ARB .....109	MCL77AB .....106	MCL97RPG .....129	RE21T.....263
MCL57AB .....97	MCL65ARB .....109	MCL77ABP .....106	MCL97RPGP .....129	RE31AS .....266
MCL57ABP .....97	MCL65CAB .....106	MCL77RB .....106	MCL98RB .....130	RE31RS .....266
MCL57ACB .....97	MCL65CABP .....106	MCL77RBP .....106	MCL98RBP .....130	RE35AB.....266
MCL57ACBP .....97	MCL65CARB .....109	MCL78RB .....127	MCL98RK .....130	RE35ABP.....266
MCL57AK .....97	MCL65CARBP .....109	MCL78RBP .....127	MCL99A1B.....111	RE35RB .....266
MCL57AKB .....97	MCL65CRB .....106	MCL81AB .....124	MCL99A1BP .....111	RE35RBP .....266
MCL57AKBP .....97	MCL65CRBP .....106	MCL81ABP .....124	MCL99AB .....111	RE37AB.....266
MCL57R1224B .....97	MCL65R24B .....106	MCL81RB .....124	MCL99ABP .....111	RE37ABP.....266
MCL57R1224BP .....97	MCL65R24BP .....106	MCL81RBP .....124	MCL99AC1B .....111	RE37RB .....266
MCL57R24B .....97	MCL65RB .....106	MCL83RB .....128	MCL99AC1BP .....111	RE37RBP .....266
MCL57R24BP .....97	MCL65RBP .....106	MCL83RBP .....128	MCL99R1B .....111	RE418T.....263
MCL57RB .....97	MCL66A24B .....122	MCL83RCB .....128	MCL99R1BP .....111	RE52ARK .....265
MCL57RBP .....97	MCL66A24BP .....122	MCL83RCBP .....128	MCL99RB .....111	RT150W12B .....263
MCL57RCB .....97	MCL66AB .....122	MCL83RK .....128	MCL99RBP .....111	RT150W12BP .....263
MCL57RCBP .....97	MCL66ABP .....122	MCL84RB .....129	MCL99RC1B .....111	RT150WBD.....263
MCL57RK .....97	MCL66APG .....122	MCL84RBP .....129	MCL99RC1BP .....111	RT150WBDP .....263
MCL57RKB .....97	MCL66APGP .....122	MCL85AB .....124	QH16CTS.....233	RT150Y1B.....264
MCL57RKBP .....97	MCL66AS .....122	MCL85ABP .....124	QH16CTSP.....233	RT150Y1BP .....264
MCL58AB .....100	MCL66CAB .....122	MCL86AB .....125	QH36CTS.....233	RT150Y1DB .....264
MCL58ABP .....100	MCL66CABP .....122	MCL86ABP .....125	QH36CTSP.....233	RT150Y1DBP .....264
MCL58ACB .....100	MCL66CRB .....122	MCL86RB .....125	RB10A.....216	RT150Y2B .....264
MCL58ACBP .....100	MCL66CRBP .....122	MCL86RBP .....125	RBL10AS .....59	RT150Y2BP .....264
MCL58AMFB .....100	MCL66R24B .....122	MCL88RCB .....127	RBL10CA .....59	RT150Y2DB .....264
MCL58AMFBP .....100	MCL66R24BP .....122	MCL88RCBP .....127	RC .....261	RT150Y2DBP .....264
MCL58RB .....100	MCL66RB .....122	MCL90AS .....103	RCP .....261	RTR03150711CB.....263
MCL58RBP .....100	MCL66RBP .....122	MCL90RS.....103	RE10018T.....263	RTR1015066CB.....263
MCL58RMFB .....100	MCL66RPG .....122	MCL91AB .....103	RE10AB.....265	RTR10150711CB.....263
MCL58RMFBP .....100	MCL66RPGP .....122	MCL91ABP .....103	RE10ABP.....265	RTR10150WB .....263
MCL59AB .....101	MCL66RS.....122	MCL91AK .....103	RE10AK.....265	RTR15066B.....263
MCL59ABP .....101	MCL67AB .....106	MCL91RB .....103	RE10RB .....265	RTR15066BP .....263
MCL59RB .....101	MCL67ABP .....106	MCL91RBP .....103	RE10RBP .....265	RTR15066PB .....263
MCL59RBP .....101	MCL67ARB .....109	MCL91RK .....103	RE10RK .....265	RTR15066PBP .....263
MCL61AB .....107	MCL67ARB .....109	MCL922RB .....131	RE11AB.....265	RTR150711B.....263
MCL61ABP .....107	MCL67RB .....106	MCL922RBP .....131	RE11ABP.....265	RTR150711BP .....263
MCL61AK .....107	MCL67RBP .....106	MCL93RB .....128	RE11RB .....265	RTR150711PB .....263
MCL61AR26BK .....109	MCL70RB .....127	MCL93RBP .....128	RE11RBP .....265	RTR150711PBP .....263
MCL61AR26KBP .....109	MCL70RBF2 .....127	MCL93RK .....128	RE12AK.....265	RTRE150GB .....264
MCL61ARB .....109	MCL70RBF2P .....127	MCL93RPG .....128	RE12ARK .....265	RTRE150GBP .....264



RTRE150OB .....264	RVPL8ABP .....243	RVSTLB0060.....234	ST36RPG.....183	ST60RS .....185
RTRE150OBP .....264	RVPL8C .....243	RVSTLB0060P.....234	ST36RPGP.....183	ST64RB .....171
RTRE150RB .....264	RVPL8CB .....243	RVSTLB0061 .....234	ST36RS .....183	ST64RBP .....171
RTRE150RBP .....264	RVPL8CBP .....243	RVSTLB0061P.....234	ST37RB .....183	ST65RB .....171
RV50BK .....237	RVPL8CP .....243	RVSTLB60.....235	ST37RBP .....183	ST65RBP .....171
RV50BKP .....237	RVPL9CC .....243	RVSTLB60P.....235	ST37RPG.....183	ST66RPG.....183
RV60BK .....234	RVPL9CCP .....243	RVSTLB61 .....235	ST37RPGP.....183	ST66RPGP.....183
RV60BKP .....234	RVPLL8A.....240	RVSTLB61P.....235	ST37RS .....183	ST67RPG.....183
RVBST55 .....238	RVPLL8AB.....240	SLL43AB1 .....70	ST3RB .....180	ST67RPGP.....183
RVBST55P .....238	RVPLL8ABP .....240	SLL43AB1P.....70	ST3RBP .....180	ST6RB .....179
RVBST56 .....238	RVPLL8AP.....240	SLL43AB2.....70	ST40RB .....173	ST6RBP .....179
RVBST56P .....238	RVPLL8C .....240	SLL43AB2P.....70	ST40RBP .....173	ST6RPG .....179
RVC100.....249	RVPLL8CB .....240	SLL43AKB1.....70	ST40RS .....173	ST6RPGP.....179
RVC100P.....249	RVPLL8CBP .....240	SLL43AKB1P .....70	ST42RB .....173	ST6RS .....179
RVFL51 .....249	RVPLL8CP .....240	SLL43AKB2.....70	ST42RBP .....173	ST70AB .....171
RVFL51P .....249	RVPLL9CC .....240	SLL43AKB2P .....70	ST42RPG.....173	ST70ABP .....171
RVIL21 .....248	RVPLL9CCP .....240	SLL72AB1 .....71	ST42RPGP.....173	ST70RB .....171
RVIL21P .....248	RVSL21 .....244	SLL72AB1P.....71	ST44AB .....169	ST70RBP .....171
RVIL21S.....248	RVSL21P .....244	SLL72AB2.....71	ST44ABP .....169	ST70RBTk .....171
RVIL22 .....248	RVSL31 .....244	SLL72AB2P.....71	ST44RB .....169	ST70RBTkP .....171
RVIL22P .....248	RVSL31P .....244	SLL72AKB1.....71	ST44RBP .....169	ST70RK .....171
RVIL22S.....248	RVST50 .....237	SLL72AKB1P .....71	ST45AB .....169	ST70RS .....171
RVIL35 .....247	RVST50P .....237	SLL72AKB2.....71	ST45ABP .....169	ST74AB .....171
RVIL35P .....247	RVST50S.....237	SLL72AKB2P .....71	ST45RB .....169	ST74ABP .....171
RVIL36 .....247	RVST51 .....237	SLL93AB.....72	ST45RBP .....169	ST74RB .....171
RVIL36P .....247	RVST51P .....237	SLL93ABP.....72	ST45RGB.....169	ST74RBP .....171
RVILL33.....246	RVST51S.....237	SLL93RB .....72	ST45RGBP.....169	ST75AB .....171
RVILL33P.....246	RVST55 .....238	SLL93RBP .....72	ST45RK .....169	ST75ABP .....171
RVILL34.....246	RVST55P .....238	ST16RB .....182	ST45RS .....169	ST77AB .....171
RVILL34P.....246	RVST55S.....238	ST16RBP .....182	ST46RB .....169	ST77ABP .....171
RVILL39.....245	RVST56 .....238	ST16RS .....182	ST46RBP .....169	ST7RB .....179
RVILL39P.....245	RVST56P .....238	ST17RB .....182	ST47RB .....170	ST7RBP .....179
RVPL1A .....241	RVST56S.....238	ST17RBP .....182	ST47RBP .....170	ST7RPG.....179
RVPL1AP .....241	RVST60 .....236	ST17RS .....182	ST47RKB.....170	ST7RPGP.....179
RVPL1C .....241	RVST60P .....236	ST20RS .....177	ST47RKBp.....170	ST7RS .....179
RVPL1CP .....241	RVST60S.....236	ST21RS .....177	ST47RLB .....170	ST8RB .....178
RVPL3A .....241	RVST61 .....236	ST24RB .....177	ST47RLBP .....170	ST8RBP .....178
RVPL3AP .....241	RVST61P .....236	ST24RBP .....177	ST4RB .....181	ST8RHB .....178
RVPL3C .....241	RVST61S.....236	ST25RB .....177	ST4RBP .....181	ST8RS .....178
RVPL3CP .....241	RVSTB50 .....237	ST25RBP .....177	ST4RS .....181	ST90AB .....174
RVPL5A .....242	RVSTB50P .....237	ST26RPG.....182	ST51RB .....176	ST90ABP .....174
RVPL5AB .....242	RVSTB51 .....237	ST26RPGP.....182	ST51RBP .....176	ST90RB .....174
RVPL5ABP .....242	RVSTB51P .....237	ST27RPG.....182	ST51RS .....176	ST90RBP .....174
RVPL5AP .....242	RVSTB60 .....236	ST27RPGP.....182	ST52AA .....176	ST92AB .....175
RVPL5C .....242	RVSTB60P .....236	ST2RB .....180	ST52AAP .....176	ST92ABP .....175
RVPL5CB .....242	RVSTB61 .....236	ST2RBP .....180	ST52RA .....176	ST92RB .....175
RVPL5CBP .....242	RVSTB61P .....236	ST31RB .....185	ST52RB .....176	ST92RBP .....175
RVPL5CP .....242	RVSTL0060.....234	ST31RBP .....185	ST52RBP .....176	ST9RB .....178
RVPL7A .....242	RVSTL0060P.....234	ST31RS .....185	ST53AAB.....176	ST9RBP .....178
RVPL7AB .....242	RVSTL0061.....234	ST33AB .....172	ST53AABP.....176	ST9RHB .....178
RVPL7ABP .....242	RVSTL0061P.....234	ST33ABP .....172	ST56RS .....184	ST9RS .....178
RVPL7AP .....242	RVSTL60.....235	ST33RB .....172	ST57RS .....184	STL0016RB .....55
RVPL7C .....242	RVSTL60P.....235	ST33RBP .....172	ST5RB .....181	STL0016RBP .....55
RVPL7CB .....242	RVSTL60S.....235	ST34RB .....172	ST5RBP .....181	STL0016RS.....55
RVPL7CBP .....242	RVSTL61 .....235	ST34RBP .....172	ST5RS .....181	STL0017RB .....55
RVPL7CP .....242	RVSTL61P.....235	ST36RB .....183	ST60RB .....185	STL0017RBP .....55
RVPL8AB .....243	RVSTL61S.....235	ST36RBP .....183	ST60RBP .....185	STL0017RS.....55

STL002AB.....28	STL101RKB.....8	STL13RH1BP.....14	STL22CCAB.....29	STL413RMBP.....15
STL002ABP.....28	STL101RMB.....8	STL13RH3B.....14	STL22CCABP.....29	STL42AB.....12
STL002RB.....28	STL101RMBP.....8	STL13RH3BP.....14	STL22CCRB.....29	STL42ABP.....12
STL002RBP.....28	STL108RB.....48	STL13RK.....14	STL22CCRBP.....29	STL42AMB.....12
STL002RFB.....28	STL108RBP.....48	STL13RKB.....14	STL22RB.....29	STL42AMB.....12
STL002RFBP.....28	STL109RB.....48	STL13RKB.....14	STL22RBH.....29	STL42RB.....12
STL002RK.....28	STL109RBP.....48	STL13RMB.....14	STL22RBHP.....29	STL42RBP.....12
STL002RK2B.....28	STL111AB.....20	STL13RMBP.....14	STL22RBP.....29	STL42RMB.....12
STL002RK2BP.....28	STL111ABP.....20	STL13RS.....14	STL22RCB.....29	STL42RMBK.....12
STL002RMB.....28	STL111ACB.....20	STL14RB.....53	STL22RCBP.....29	STL42RMBKP.....12
STL002RMBP.....28	STL111ACBP.....20	STL14RBP.....53	STL23A24B.....17	STL42RMBP.....12
STL002RS.....28	STL111RB.....20	STL153ARDBB.....42	STL23A24BP.....17	STL42RS.....12
STL003AB.....16	STL111RBP.....20	STL153ARDBBP.....42	STL23AB.....17	STL43A24B.....11
STL003ABP.....16	STL111RCB.....20	STL153ARPBB.....42	STL23ABP.....17	STL43A24BP.....11
STL003RB.....16	STL111RCBP.....20	STL153ARPBBP.....42	STL23CCRB.....17	STL43AB.....11
STL003RBP.....16	STL111RCFB.....21	STL15RB.....53	STL23CCRBP.....17	STL43ABP.....11
STL003RFB.....16	STL111RCFBP.....21	STL15RBP.....53	STL23R24B.....17	STL43ABX.....13
STL003RFBP.....16	STL111RCFMB.....21	STL161RB.....46	STL23R24BP.....17	STL43ABXP.....13
STL003RFLB.....16	STL111RCFMBP.....21	STL161RBP.....46	STL23RB.....17	STL43ABXS.....13
STL003RFLBP.....16	STL111RCMB.....20	STL161RLB.....46	STL23RBP.....17	STL43AKB.....11
STL003RFMB.....16	STL111RCMBP.....20	STL161RLBP.....46	STL26RB.....56	STL43AKBP.....11
STL003RFMBP.....16	STL111RFB.....21	STL16NTRB.....54	STL26RBP.....56	STL43R24B.....11
STL003RK.....16	STL111RFBP.....21	STL16NTRBP.....54	STL27RB.....56	STL43R24BP.....11
STL003RMB.....16	STL111RFMB.....21	STL16RB.....54	STL27RBP.....56	STL43RB.....11
STL003RMBP.....16	STL111RFMBP.....21	STL16RBP.....54	STL28RB.....52	STL43RBHX.....13
STL003RS.....16	STL111RHB.....20	STL16RS.....54	STL28RBP.....52	STL43RBHXP.....13
STL003SRFLB.....16	STL111RHBP.....20	STL175AMFB.....31	STL29RB.....52	STL43RBP.....11
STL003SRFLBP.....16	STL111RMB.....20	STL175AMFBP.....31	STL29RBP.....52	STL43RBX.....13
STL008RB.....51	STL111RMBP.....20	STL178RB.....22	STL2RB.....50	STL43RXP.....13
STL008RBP.....51	STL112RB.....23	STL178RBP.....22	STL2RBP.....50	STL43RBXS.....13
STL008RPG.....51	STL112RBP.....23	STL178RCCFPB.....22	STL33RB.....35	STL43RK.....11
STL008RPGP.....51	STL113RB.....10	STL178RCCFPBP.....22	STL33RBP.....35	STL43RKB.....11
STL008RS.....51	STL113RBP.....10	STL178RCFPB.....22	STL33RFB.....35	STL43RKB.....11
STL009RB.....51	STL116RB.....53	STL178RCFPBP.....22	STL33RFBP.....35	STL43RMB.....11
STL009RBP.....51	STL116RBP.....53	STL178RFPB.....22	STL34RB.....35	STL43RMBP.....11
STL009RPG.....51	STL117RB.....53	STL178RFPBP.....22	STL34RBP.....35	STL512RB.....23
STL009RPGP.....51	STL117RBP.....53	STL179RB.....39	STL35AB.....36	STL512RBP.....23
STL009RS.....51	STL12RB.....26	STL179RBP.....39	STL35ABP.....36	STL512RCB.....23
STL101AB.....8	STL12RBP.....26	STL17NTRB.....54	STL35RB.....36	STL512RCBP.....23
STL101ABP.....8	STL12RK.....26	STL17NTRBP.....55	STL35RBP.....36	STL513RB.....10
STL101ACB.....8	STL12RK2B.....26	STL17RB.....54	STL36RB.....57	STL513RBP.....10
STL101ACBP.....8	STL12RKB.....26	STL17RBP.....54	STL36RBP.....57	STL513RCB.....10
STL101RB.....8	STL12RMB.....26	STL17RS.....54	STL36RPG.....57	STL513RCBP.....10
STL101RBP.....8	STL12RMBP.....26	STL190AB.....44	STL36RPGP.....57	STL52ARB.....43
STL101RCB.....8	STL12RS.....26	STL190ABP.....44	STL36RS.....57	STL52ARB.....43
STL101RCBP.....8	STL133RB.....34	STL190RB.....44	STL37RB.....57	STL53ARDB.....43
STL101RCFB.....9	STL133RBP.....34	STL190RBP.....44	STL37RBP.....57	STL53ARDBP.....43
STL101RCFBP.....9	STL13RB.....14	STL201RB.....5	STL37RPG.....57	STL53ARPB.....43
STL101RCFMB.....9	STL13RBP.....14	STL201RBP.....5	STL37RPGP.....57	STL53ARPB.....43
STL101RCFMBP.....9	STL13RFB.....14	STL201RFMB.....4	STL37RS.....57	STL53RCB.....11
STL101RCMB.....8	STL13RFBP.....14	STL201RFMBP.....4	STL3RB.....50	STL53RCBP.....11
STL101RCMBP.....8	STL13RFMB.....14	STL211RB.....6	STL3RBP.....50	STL543RB.....18
STL101RFB.....9	STL13RFMBP.....14	STL211RBP.....6	STL412RB.....27	STL543RBP.....18
STL101RFBP.....9	STL13RFS.....14	STL211RCB.....6	STL412RBP.....27	STL55AB.....19
STL101RFMB.....9	STL13RGB.....14	STL211RCBP.....6	STL413RB.....15	STL55ABP.....19
STL101RFMBP.....9	STL13RGBP.....14	STL22AB.....29	STL413RBP.....15	STL55RB.....19
STL101RKB.....8	STL13RH1B.....14	STL22ABP.....29	STL413RMB.....15	STL55RBP.....19

# INDEX

STL55RFMB .....19	STL72RMB .....24	STL9R3B .....49	TLL46TB .....160	UCL13CPGP .....142
STL55RFMBP .....19	STL72RMBP .....24	STL9R3BP .....49	TLL46TBP .....160	UCL160CB .....145
STL56RB .....58	STL72RS .....24	STL9RB .....49	TLL48FB .....161	UCL160CBP .....145
STL56RBP .....58	STL73RB .....27	STL9RBP .....49	TLL48FBP .....161	UCL178RFP2B .....141
STL572AB .....30	STL73RBP .....27	TL106CS .....231	TLL50FB .....161	UCL178RFP2BP .....141
STL572ABP .....30	STL73RK .....27	TL10C24VB .....231	TLL50FBP .....161	UCL19CB .....143
STL572RB .....30	STL73RKB .....27	TL10C24VBP .....231	TLL51FB .....162	UCL19CBP .....143
STL572RBP .....30	STL73RKBP .....27	TL10CB .....231	TLL51FBP .....162	UCL50CB .....143
STL57RB .....58	STL74RBK .....24	TL10CBP .....231	TLL51FRPG .....162	UCL50CBP .....143
STL57RBP .....58	STL74RBKP .....24	TL10CS .....231	TLL52FB .....162	UCL55CB .....144
STL60RB .....47	STL74RKB .....24	TL10SS .....231	TLL52FBP .....162	UCL55CBP .....144
STL60RBP .....47	STL74RKBP .....24	TL11CPG .....231	TLL52FPBB .....163	UCL60CB .....145
STL60RLB .....47	STL75AB .....33	TL12CS .....231	TLL52FPBBP .....163	UCL60CBB .....145
STL60RLBP .....47	STL75ABP .....33	TL15RK .....182	TLL52FWB .....162	UCL60CBBP .....145
STL61RB .....47	STL75AMB .....33	TL16RK .....182	TLL52FWBP .....162	UCL60CBP .....145
STL61RBP .....47	STL75AMBP .....33	TL22RK .....186	TLL54TB .....163	UCL60CSBB .....145
STL61RLB .....47	STL75AMFB .....32	TL27BK .....178	TLL54TBP .....163	UCL60CSBBP .....145
STL61RLBP .....47	STL75AMFBP .....32	TL29BK .....178	TLL55FB .....164	UCL60CSCB .....145
STL63CRB .....37	STL76RB .....41	TL35FS .....231	TLL55FBP .....164	UCL60CSNB .....145
STL63CRBP .....37	STL76RBP .....41	TL35TB .....231	TLL56FB .....164	UCL60CSNBP .....145
STL63RB .....37	STL78AB .....25	TL35TS .....231	TLL56FBP .....164	UCL60CSWNB .....145
STL63RBP .....37	STL78ABP .....25	TL36RK .....183	TLL56RK .....58	UCL60CSWNB .....145
STL68RB .....7	STL78RB .....25	TL46FS .....231	TLL57FB .....164	UCL65CB .....144
STL68RBP .....7	STL78RBP .....25	TL46TS .....231	TLL57FBP .....164	UCL65CBP .....144
STL68RPB .....7	STL78REZB .....25	TL5RK .....179	TLL60FB .....165	UL11BS .....200
STL68RPBP .....7	STL78REZBP .....25	TL60RK .....181	TLL60FBP .....165	UL53CB .....227
STL69CRPG .....38	STL78RK .....25	TL8RK .....178	TLL64FB .....165	UL53CBP .....227
STL69CRPGP .....38	STL78RLPB .....25	TL9RK .....179	TLL64FBP .....165	UL56CB .....227
STL69RB .....38	STL78RLPBP .....25	TLL0016RK .....55	TLL70FB .....166	UL56CBP .....227
STL69RBP .....38	STL78RPG .....25	TLL002RK .....28	TLL70FBP .....166	UL71CS .....226
STL69RCB .....38	STL78RPGP .....25	TLL008RK .....51	TLL71FB .....166	UL94CB .....225
STL69RCBMCV2B .....38	STL79RB .....40	TLL112RK .....20	TLL71FBP .....166	UL94CBP .....225
STL69RCBMCV2BP .....38	STL79RBP .....40	TLL12RK .....26	TLL72FB .....167	UL95CB .....225
STL69RCBP .....38	STL79RS .....40	TLL144FSL .....159	TLL72FBP .....167	UL95CBP .....225
STL69RK .....38	STL7RS .....49	TLL150FSL .....161	TLL73FB .....167	UL97CPG .....226
STL69RRXB .....38	STL80RB .....40	TLL152FSL .....162	TLL73FBP .....167	UL97CPGP .....226
STL69RRXBP .....38	STL80RBP .....40	TLL160RK .....54	TLL80FB .....168	ULL25CB .....157
STL69RRXCS .....38	STL82RCB .....24	TLL16RK .....54	TLL80FBP .....168	ULL25CBP .....157
STL69RS .....38	STL82RCBP .....24	TLL170RK .....53	TLL80WFB .....168	ULL25CTB .....157
STL6RS .....49	STL88RCB .....25	TLL190RK .....48	TLL80WFBP .....168	ULL25CTBP .....157
STL70AB .....30	STL88RCBP .....25	TLL21RK .....59	TLL90RK .....49	
STL70ABP .....30	STL88RCBP .....25	TLL22RK .....29	TLL9RK .....49	
STL70RB .....30	STL88RCBP .....25	TLL25FS .....168	UCL09CB .....141	
STL70RBP .....30	STL89RCB .....40	TLL26RK .....56	UCL09CBB .....141	
STL71AMB .....32	STL89RCBP .....40	TLL28RK .....52	UCL09CBBP .....141	
STL71AMBP .....32	STL8R3B .....49	TLL29RK .....52	UCL09CBP .....141	
STL72AB .....24	STL8R3BP .....49	TLL30FB .....158	UCL11CB .....142	
STL72ABP .....24	STL8RB .....49	TLL30FBP .....158	UCL11CBP .....142	
STL72AMB .....24	STL8RBP .....49	TLL31RK .....59	UCL11CKB .....142	
STL72AMBP .....24	STL90A24B .....45	TLL36RK .....57	UCL11CKBP .....142	
STL72CAB .....24	STL90A24BP .....45	TLL44FB .....159	UCL11CKPG .....142	
STL72CABP .....24	STL90AB .....45	TLL44FBP .....159	UCL11CKPGP .....142	
STL72RB .....24	STL90ABP .....45	TLL45FB .....159	UCL13C2PG .....142	
STL72RBP .....24	STL90R24B .....45	TLL45FBP .....159	UCL13C2PGP .....142	
STL72RK .....24	STL90R24BP .....45	TLL46CFB .....160	UCL13CB2B .....142	
STL72RKB .....24	STL90RB .....45	TLL46CFBP .....160	UCL13CB2BP .....142	
STL72RKBP .....24	STL90RBP .....45	TLL46CFPG .....160	UCL13CPG .....142	

On our website you can discover more about Trailer Hitches & Towing.