

GptrONICS®

Better Value • Better Options • Better Lighting



CONTENTS

All Optronics products conform to DOT/SAE/FMVSS/CMVSS 108 standards where applicable when applied according to federal lighting requirements

LED TRUCK & TRAILER LIGHTING	2 - 229
Headlamps	2
FUSION™ Stop/Turn/Tail/Back-Up Lamps.....	6
Sealed Stop/Turn/Tail Lights & Parking/Turn Signals	14
Combination Tail Lights & Kits	46
DOT Compliant Back-Up Lights	77
Warning Lights	89
Millennium® Series.....	101
Sealed Marker/Clearance Lights	108
Surface Mount Marker/Clearance Lights.....	138
Identification Light Bars	163
License Plate Lights	170
Interior & Utility Lights	179
Work & Off-Road Lights	211
INCANDESCENT TRUCK & TRAILER LIGHTING	230 - 293
Sealed Stop/Turn/Tail Lights & Parking/Turn Signals	230
Combination Tail Lights & Kits	234
DOT Compliant Back-Up Lights	248
Millennium Series®	250
Sealed Marker/Clearance Lights	252
Surface Mount Marker/Clearance Lights.....	261
Identification Light Bars	275
License & Utility Lights	278
Utility & Interior Lights	287
Halogen Lights.....	291
RV LIGHTS & ACCESSORIES	294 - 322
ACCESSORIES - CONSPICUITY, MOUNTING, WIRING	323 - 357
FMVSS LIGHTING REQUIREMENTS	358 - 364
INDEX	365 - 377
MATRICES	378 - 383





HLL70HLB



HLL70 SERIES DOT Compliant High/Low Beam Sealed LED Headlamp

- Replace standard 5" x 7" sealed beam halogen and HID headlights
- Light output whiter than incandescent for greater visibility
- Long lasting, energy efficient - diodes last up to 50 times longer than incandescent, draws just 1.1 amp
- Dual power: use with 12VDC or 24VDC systems
- Hard wired design with industry standard H4 three-blade connector
- Die cast aluminum construction with powder coat finish resists corrosion
- Tough polycarbonate lens
- IP67 rating: protected from dust and capable of withstanding water immersion, offering increased reliability and service life

BULK P/N	POLYPACK P/N	DESCRIPTION	QTY
HIGH/LOW BEAM HEADLAMP - 12 DIODES			
HLL70HLB	HLL70HLBP	12-24VDC High/Low beam	1
RETAIL			
HLL70HLS		Single light, Retail Box	1

IP67 rating: protected from dust and capable of withstanding water immersion, offering increased reliability and service life

FMVSS	HL
MATERIALS	Polycarbonate lens, aluminum housing
VOLT/AMP	12.8VDC - High 1.13A, Low 0.85A
WT/DIMS	2.99 lbs. / 7.937" x 5.625" x 3.5"
WARRANTY	Lifetime LED Warranty

HLL93 SERIES

DOT Compliant High/Low Beam Sealed LED Headlamp

- Raw lumen output: 2460 lm, Effective lumen output: 1722 lm
- Replace standard 7" sealed beam halogen and HID headlights
- Light output whiter than incandescent for greater visibility
- Long lasting, energy efficient - diodes last up to 50 times longer than incandescent, draw less than 1 amp
- Dual power: use with 12VDC or 24VDC systems
- Die cast aluminum construction with powder coat finish resists corrosion
- Tough polycarbonate lens
- IP67 rating: protected from dust and capable of withstanding water immersion, offering increased reliability and service life

BULK P/N	POLYPACK P/N	DESCRIPTION	QTY
HIGH/LOW BEAM HEADLAMP - 12 DIODES			
HLL93HLB	HLL93HLBP	12-24VDC High/low beam	1
RETAIL			
HLL93HLS		Single light, Retail Box	1

IP67 rating: protected from dust and capable of withstanding water immersion, offering increased reliability and service life

FMVSS	HL
MATERIALS	Polycarbonate lens and aluminum housing
VOLT/AMP	12.8VDC - High Beam .84A / Low Beam .41A
WT/DIMS	1.721 lbs. / 7" x 7" x 3.25"
WARRANTY	Lifetime LED Warranty

Opti-Brite



HLL93HLB



HLL93HLS

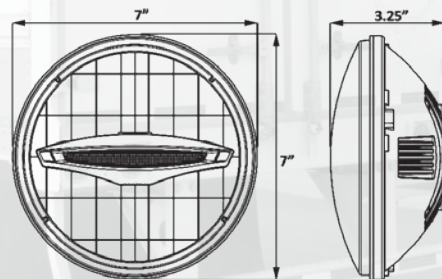



HLL78/79 SERIES

DOT Compliant High and Low Beam Sealed LED Headlamps



HLL78LB





HLL79HB



HLL78LS

- Raw lumen output: 2340 lm, Effective lumen output: 1638 lm
- Replace standard 4" x 6" sealed beam halogen and HID headlamps
- Light output whiter than incandescent for greater visibility
- Long lasting, energy efficient – diodes last up to 50 times longer than incandescent, draw less than 1 amp
- Dual power: use with 12VDC or 24VDC systems
- Hard wired with standard H4 3-blade connector; 16 gauge, 7-inch leads
- Die cast aluminum construction with powder coat finish resists corrosion
- Tough polycarbonate lens with protective coating

BULK P/N	POLYPACK P/N	DESCRIPTION	QTY
LOW BEAM HEADLAMP - 11 DIODES			
HLL78LB	HLL78LBP	12-24VDC Low beam	1
HIGH BEAM HEADLAMP - 11 DIODES			
HLL79HB	HLL79HBP	12-24VDC High beam	1
RETAIL			
HLL78LS		Low beam, Retail Box	10
HLL79HS		High beam, Retail Box	10

IP67 rating: protected from dust and capable of withstanding water immersion, offering increased reliability and service life

FMVSS	HL
MATERIALS	Polycarbonate lens, aluminum housing
VOLT/AMP	12.8VDC - High 1.47A / Low 1.35A
WT/DIMS	1.858 lbs. / 6.58" x 4.2" x 3.32"
WARRANTY	Lifetime LED Warranty

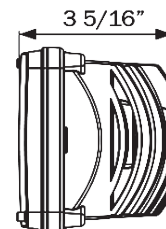
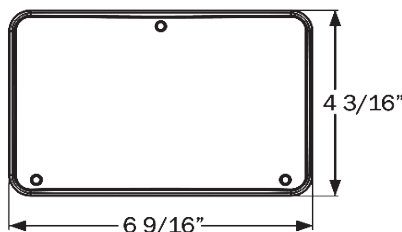

HLL90 & HLL88/89 SERIES DOT Compliant High/Low Beam Sealed LED Headlamp

- Replace standard sealed beam halogen and HID headlamps
- Light output whiter than incandescent for greater visibility
- Dual power: use with 12VDC or 24VDC systems
- Hard wired with standard H4 3-blade connector; 16 gauge, 7-inch leads

BULK P/N	POLYPACK P/N	DESCRIPTION	QTY
7" HIGH/LOW BEAM HEADLAMP - 16 DIODES			
HLL90HLB	HLL90HLBP	12-24VDC High/low beam	1
4"x6" LOW BEAM HEADLAMP - 8 DIODES			
HLL88LB	HLL88LBP	12-24VDC Low beam	1
4"x6" HIGH BEAM HEADLAMP - 8 DIODES			
HLL89HB	HLL89HBP	12-24VDC High beam	1

IP67 rating: protected from dust and capable of withstanding water immersion, offering increased reliability and service life

FMVSS	HL
MATERIALS	Polycarbonate lens, aluminum housing
VOLT/AMP	HLL90: 12.8VDC - High Beam 1.85A / Low Beam 1.80A HLL88/89: 12.8VDC - 0.85A
WT/DIMS	HLL90: 2.05 lbs. / 7" x 7" x 2.8" HLL88/89: 1.14 lbs. / 6.563" x 4.188" x 3.313"
WARRANTY	Lifetime LED Warranty

Opti-Brite



HLL90HLB

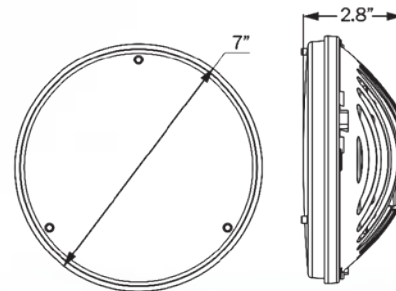

HLL88LB



HLL89HB

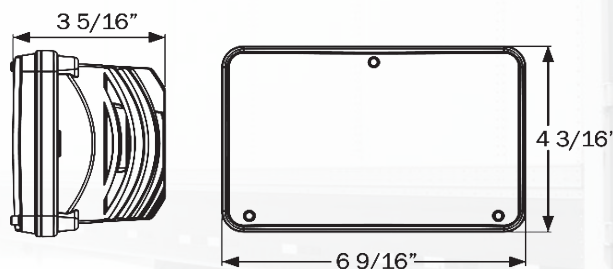



STL201 GLOLIGHT® SERIES

GloLight® FUSION™ 4" Round Sealed Stop/Turn/Tail/Back-Up Light with Mounting Flange

PATENTED TECHNOLOGY

- DOT-compliant back-up light built into stop/turn/tail light
- Sonically sealed, weathertight connections
- Multi-function: Stop, turn, tail and back-up, all in one light
- Recess flange mount design for secure installation



STL201RFMB

BULK P/N	POLYPACK P/N	DESCRIPTION	QTY
RED STOP/TURN/TAIL/BACK-UP LIGHT - 24 DIODES			
STL201RFMB	STL201RFMBP	Weathertight connection	10
ACCESSORIES			
A45PMB	A45PMBP	Weathertight pigtail, 3-wire	50
A42PMB	A42PMBP	Weathertight pigtail, 2-wire	100

FMVSS	S2 T2 I6 (2)R
MATERIALS	Polycarbonate lens and housing
VOLT/AMP	12.8VDC - .316A Stop/Turn, .15A Tail, .3A Back-Up
WT/DIMS	.38 lbs. / 5.5" x 5.5" x 1.5"
WARRANTY	Lifetime LED Warranty

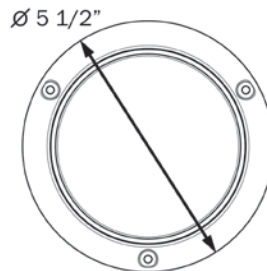
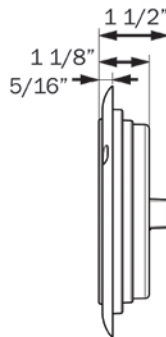

HOLE CUT-OUT: 4.5"



Weather-tight connection

STL201X SERIES FUSION™ 4" Round Sealed Stop/Turn/Tail/Back-Up Light



PATENTED TECHNOLOGY

- DOT-compliant back-up light built into stop/turn/tail light
- Sonically sealed, waterproof
- Multi-function: Stop, turn, tail and back-up, all in one light
- Accepts industry standard PL-3 plugs



STL201XRB

BULK P/N	POLYPACK P/N	DESCRIPTION	QTY
RED STOP/TURN/TAIL/BACK-UP LIGHT - 16 DIODES			
STL201XRB	STL201XRBP	PL-3 connections	10
STL201XR1224B	STL201XR1224BP	PL-3 connections, 12/24V	10
ACCESSORIES			
A45GB	A45GBP	Grommet	50
A46GB	A46GBP	New design grommet	50
A45BB	A45BBP	Black plastic mounting flange	100
A45SB	A45SBP	Stainless steel mounting flange	20
A45PB	A45PBP	Straight pigtail, 3-wire PL-3	100
A47PB	A47PBP	Right angle pigtail, 3-wire PL-3	100
A45CB	A45CBP	Pigtail, 2-wire	100
A49PB	A49PBP	Right angle pigtail, 2-wire	100
BK45BB	BK45BBP	Black steel bracket	10

FMVSS	S2 T2 I6 (2)R
MATERIALS	Polycarbonate lens and housing
VOLT/AMP	12.8VDC - .375A Stop/Turn, .145A Tail, .3A Back-Up
WT/DIMS	.35 lbs. / 4.313" x 4.313" x 1.625"
WARRANTY	Lifetime LED Warranty



Standard PL3 connections

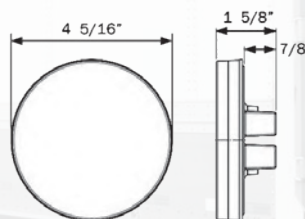

HOLE CUT-OUT: 4.5"



STL201XRFHXB

FUSION™ 4" Round Surface Mount Stop/Turn/Tail/Back-Up Light with Reflex Mounting Flange



PATENTED TECHNOLOGY

- Sonically sealed, waterproof
- Multi-Function: stop/turn/tail/back-up with reflex flange - all in one light
- FMVSS compliant for over 80" applications
- Surface mount
- Hard wired, includes 8" lead and ground wires

BULK P/N	POLYPACK P/N	DESCRIPTION	QTY
RED STOP/TURN/TAIL/BACK-UP LIGHT - 20 DIODES			
STL201XRFHXB	STL201XRFHXP	Hard wired, 8" leads	10

FMVSS	S2 T2 I6 (2)R A
MATERIALS	Polycarbonate lens and housing
VOLT/AMP	12.8VDC - .375A Stop/Turn, .145A Tail, .3A Back-Up
WT/DIMS	.38 lbs. / 5.44" x 5.44" x .79"
WARRANTY	Lifetime LED Warranty

STL201XRFHXB

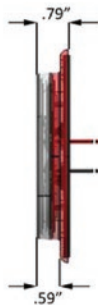
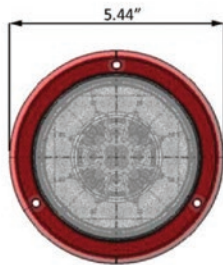

STL1211 SERIES

FUSION™ GloLight® LED 6" Surface Mount Stop/Turn/Tail/Back-Up Light



PATENTED TECHNOLOGY

- Sonically sealed, waterproof
- Multi-function: stop/turn/tail/back-up
- GloLight shape illuminates for tail light function
- Clear lens, red and white diodes
- Surface flange mount
- Hard wired with female PL-3 plugs



STL1211RCFHGP

BULK P/N	POLYPACK P/N	DESCRIPTION	QTY
STOP/TURN/TAIL/BACK-UP LIGHT - 22 DIODES			
STL1211RCFHGP	STL1211RCFHGP	Red, hard wired	10
ACCESSORIES			
A211NCCB	A211NCCBP	Snap-on bezel, unfinished	50
A78RXB	A78RXBP	Red reflex, snap-on trim ring FMVSS "A"	25
A178TRSSB	A178TRSSBP	Stainless steel, screw mount trim ring	50

FMVSS	S2 T2 I6 (2)R
MATERIALS	Polycarbonate lens and housing
VOLT/AMP	12.8VDC - .375A Stop/Turn, .02A Tail, .242A Back-up
WT/DIMS	.4 lbs. / 7.52" x 3.29" x 1.01"
WARRANTY	Lifetime LED Warranty

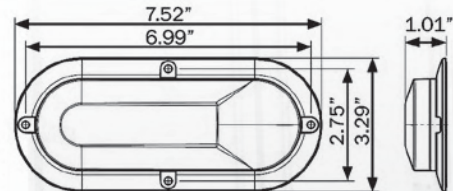



STL211X SERIES FUSION™ 6" Oval Sealed LED Stop/Turn/Tail/Back-Up Lights

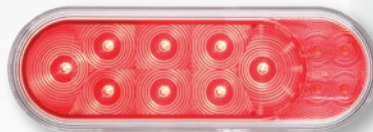

STL211XRB



STL211XRCB



TLL211XRTMK

PATENTED TECHNOLOGY

- DOT-compliant back-up light built into stop/turn/tail light
- Sonically sealed, waterproof
- Multi-function: Stop, turn, tail and back-up, all in one light
- Accepts industry standard PL-3 plugs

BULK P/N	POLYPACK P/N	DESCRIPTION	QTY
RED STOP/TURN/TAIL/BACK-UP LIGHT - 16 DIODES			
STL211XRB	STL211XRBP	Red lens, PL-3 connection	10
STL211XRCB	STL211XRCBP	Clear lens, PL-3 connection	10
ACCESSORIES			
A70GB	A70GBP	Grommet, flush mount	50
A45PB	A45PBP	Pigtail, 3-wire	100
A47PB	A47PBP	Right angle pigtail, 3-wire	100
A45CB	A45CBP	Pigtail, 2-wire	100
A49PB	A49PBP	Right angle pigtail, 2-wire	100
A77S1B	A77S1BP	Gray, flat design steel bracket	50
BK70BB	BK70BBP	Black steel bracket	10

RETAIL

TLL211XRTMK		Try Me Retail Kit: (2) ea. STL211XRB, A70GB, A45PB, A45CB, and (1) A30W5BLB 5-way harness, clam	6
-------------	---	--	---

FMVSS	S2 T2 I6 (2)R
MATERIALS	Polycarbonate lens and housing
VOLT/AMP	12.8VDC - .375A Stop/Turn, .020A Tail, .242A Back-Up
WT/DIMS	.35 lbs. / 6.438" x 2.313" x 1.50"
WARRANTY	Lifetime LED Warranty

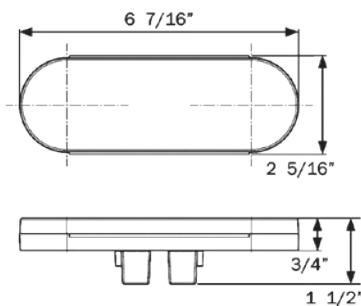

HOLE CUT-OUT: 6.85" X 2.5"
(1.25" R)



Standard PL3 connections

STL211XRFHB FUSION™ LED 6" Surface Mount Stop/Turn/Tail/Back-Up Light

PATENTED TECHNOLOGY

- DOT-compliant back-up light built into stop/turn/tail light
- Flange surface mount—no panel cut-out required
- Sonically sealed, waterproof
- Hard wired, with 8-in leads

BULK P/N	POLYPACK P/N	DESCRIPTION	QTY
STOP/TURN/TAIL/BACK-UP LIGHT - 17 DIODES			
STL211XRFHB	STL211XRFHBP	Hard wired	10
STL211XRFHGP	STL211XRFHGP	Hard wire, female PL-2 and PL-3 plugs	10
ACCESSORIES			
A211CB1	A211CB1P	Chrome, snap-on bezel	25
A211NCCB	A211NCCBP	Snap-on bezel, unfinished	50
A211RXB	A211RXBP	Red reflex flange ring	25
A178TRSSB	A178TRSSBP	Stainless steel, screw mount trim ring	50

FMVSS	S2 T2 (2)R
MATERIALS	Polycarbonate lens and housing
VOLT/AMP	12.8VDC - .265A Stop/Turn, .24A Tail, .3A Back-up
WT/DIMS	.4 lbs. / 7.5" x 3.25" x .75"
WARRANTY	Lifetime LED Warranty



STL211XRFHB

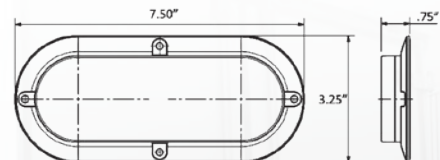



STL68RB



A68SSB

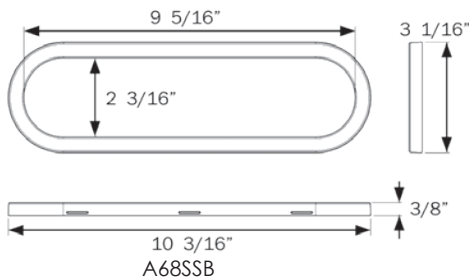
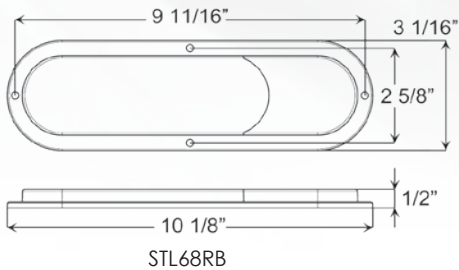

STL68 SERIES

FUSION™ Surface Mount LED Combination Stop/Turn/Tail/Back-Up Light

PATENTED TECHNOLOGY

- Sonically sealed, waterproof
- Low profile design—only 1/2" thick
- Surface mount on 9-11/16" centers
- Hard wired with separate ground wire

BULK P/N	POLYPACK P/N	DESCRIPTION	QTY
STOP/TURN/TAIL/BACK-UP LIGHT - 14 DIODES			
STL68RB	STL68RBP	Red, hard wired	10
STL68RPB	STL68RPBP	Red, .180 male bullets	10
ACCESSORIES			
A68SSB	A68SSBP	Stainless steel snap-on ring	20

FMVSS	S2 T2 I6 (2)R
MATERIALS	Polycarbonate lens and housing
VOLT/AMP	12.8VDC - .35A Stop/Turn, .05A Tail, .3A Back-up
WT/DIMS	.275 lbs. / 10.125" x 3.063" x 0.5"
WARRANTY	Lifetime LED Warranty

STL264 SERIES FUSION™ LED Thinline Stop/ Turn/Tail/Back-Up Lights



STL264RB



STL264RCB

PATENTED TECHNOLOGY

- Sonically sealed, waterproof
- Low profile design—only 1/2" thick
- Surface mount on 9-11/16" centers
- Hard wired with separate ground wire

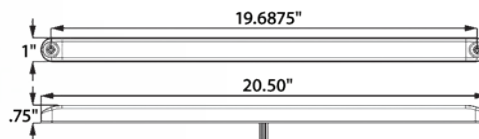

BULK P/N	POLYPACK P/N	DESCRIPTION	QTY
STOP/TURN/TAIL/BACK-UP LIGHT - 19 DIODES			
STL264RB	STL264RBP	Red, hard wired	10
STL264RCB	STL264RCBP	Clear lens, red, hard wired	10
ACCESSORIES			
A64CRB	A64CRBP	Chrome base/bezel	50
A64BB	A64BBP	Black base/bezel	50

FMVSS	S2 T2 I6 (2)R
MATERIALS	Polycarbonate lens and housing
VOLT/AMP	12.8VDC - .265A Stop/Turn, .24A Tail, .3A Back-up
WT/DIMS	.441 lbs. / 20.5" x 1" x .75"
WARRANTY	Lifetime LED Warranty



FTL42/53 SERIES 4" Round Sealed LED Front Turn Signal

- Sonically sealed, waterproof
- 10 SMD diodes
- Dual power: use with 12VDC and 24VDC systems



FTL42A1224B



FTL53ALCPG

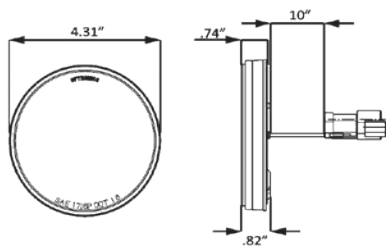

FTL53ALCPG

BULK P/N	POLYPACK P/N	DESCRIPTION	QTY
YELLOW PARKING/TURN SIGNAL - 10 DIODES			
FTL42A1224B	FTL42A1224BP	Flange mount, hard wired, 12V/24V	10
FTL53ALCPG	FTL53ALCPGP	Grommet mount, hard wired, Deutsch connection, 12/24V, protective coating on lens, EMC	10
ACCESSORIES			
A45GB	A45GBP	Grommet	50

FMVSS	Yellow I6 I7 P
MATERIALS	Polycarbonate lens and housing
VOLT/AMP	FTL42: 12.8VDC - .413A Turn, .028A Park FTL53: 12.8VDC - .357A Turn, .014A Park
WT/DIMS	FTL42: .617 lbs. / 5.5" x 5.5" x 1.938" FTL53: .265 lbs. / 4.313" x 4.313" x .82"
WARRANTY	Lifetime LED Warranty



Deutsch connection on FTL53ALCPG

STL603 SERIES

LightGuide™ LED 4" Stop/Turn/Tail Light

PATENTED TECHNOLOGY

- Central X-shaped feature illuminates for tail light function
- Surrounding diodes light for stop and turn functions
- Sonically sealed, waterproof
- Grommet mount
- Accepts industry standard PL-3 connector



STL603RB

BULK P/N	POLYPACK P/N	DESCRIPTION	QTY
RED STOP/TURN/TAIL LIGHT - 12 DIODES			
STL603RB	STL603RBP	PL-3 connection	10
ACCESSORIES			
A45GB	A45GBP	Grommet	50
A45PB	A45PBP	Pigtail, 3-wire	100
A47PB	A47PBP	Right angle pigtail, 3-wire	100
BK45BB	BK45BBP	Black steel bracket	10
A45BB	A45BBP	Black plastic flange	100
A45SB	A45SBP	Stainless steel mounting flange	20
A45CGB	A45CGBP	Chrome grommet cover	20

FMVSS	Red S2 T2 I6
MATERIALS	Polycarbonate lens and housing
VOLT/AMP	12.8VDC - .421A Stop/Turn, .114A Tail
WT/DIMS	.375 lbs. / 4.313" x 4.313" x 1.688"
WARRANTY	Lifetime LED Warranty

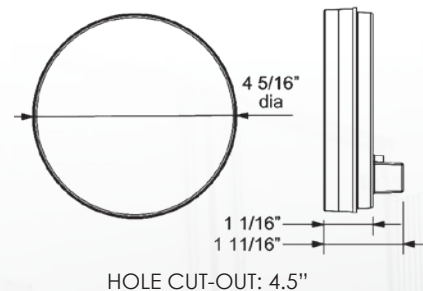

LED SEALED STOP/TURN/TAIL & PARKING/TURN SIGNALS



STL101 GROMMET MOUNT SERIES GloLight® 4" Sealed LED Lights

PATENTED TECHNOLOGY

- Sonically sealed, waterproof
- Mount in any 360 degree position
- Available in tinted and clear lens models
- Available with standard PL-3 or optional weathertight connection



BULK P/N	POLYPACK P/N	DESCRIPTION	QTY
RED STOP/TURN/TAIL LIGHT - 21 DIODES			
STL101RB	STL101RBP	PL-3 connection	10
STL101R1224B	STL101R1224BP	PL-3 connection 12/24V	10
STL101RMB	STL101RMBP	Weathertight connection	10
STL101RCB	STL101RCBP	Clear lens, red diodes, PL-3	10
STL101RCMB	STL101RCMBP	Clear lens, red diodes, weathertight	10
STL101RKB	STL101RKBP	Kit: Red stop/turn/tail light, PL-3 connection, A45GB grommet, A47PB pigtail	10
YELLOW PARKING/TURN SIGNAL - 21 DIODES			
STL101AB	STL101ABP	PL-3 connection	10
STL101ACB	STL101ACBP	Clear lens, yellow diodes, PL-3	10
ACCESSORIES			
A45GB	A45GBP	Grommet	50
A45PB	A45PBP	Pigtail, 3-wire	100
A47PB	A47PBP	Right angle pigtail, 3-wire	100
A45PMB	A45PMBP	Weathertight pigtail	100
AL45PWTB	AL45PWTBP	Weathertight to PL-3 adaptor	50
BK45BB	BK45BBP	Black steel bracket	10
A45BB	A45BBP	Black plastic flange	100
A45SB	A45SBP	Stainless steel mounting flange	20
A45CGB	A45CGBP	Chrome grommet cover	20

FMVSS	Red S2 T2 I6; Yellow I6 P
MATERIALS	Polycarbonate lens and housing
VOLT/AMP	Red: 12.8VDC - .375A Stop/Turn, .145A Tail Yellow: 12.8VDC - .315A Turn, .143A Parking
WT/DIMS	.35 lbs. / 4.313" dia x 1.375" D
WARRANTY	Lifetime LED Warranty

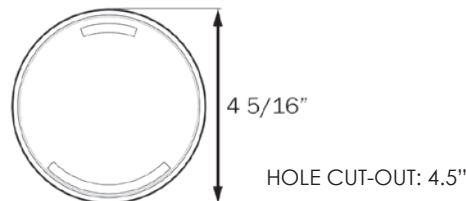

STL101 FLANGE MOUNT SERIES GloLight® 4" Sealed LED Lights with Mounting Flange

PATENTED TECHNOLOGY

- Sonically sealed, waterproof
- Flange mount for security, theft reduction
- Available in tinted and clear lens models
- Available with standard PL-3 or optional weathertight connection

BULK P/N	POLYPACK P/N	DESCRIPTION	QTY
RED STOP/TURN/TAIL LIGHT - 21 DIODES			
STL101RFB	STL101RFBP	PL-3 connection	10
STL101RFMB	STL101RFMBP	Weathertight connection	10
STL101RCFB	STL101RCFBP	Clear lens, red diodes, PL-3	10
STL101RCFMB	STL101RCFMBP	Clear lens, red diodes, weathertight	10
ACCESSORIES			
A45PB	A45PBP	Pigtail, 3-wire	100
A47PB	A47PBP	Right angle pigtail, 3-wire	100
A45PMB	A45PMBP	Weathertight pigtail	100
AL45PWTB	AL45PWTBP	Weathertight to PL-3 adaptor	50
BK45BB	BK45BBP	Black steel bracket	10
A101TRSSB	A101TRSSBP	Stainless steel trim ring	50
A42GB	A42GBP	Mounting gasket, black	100

FMVSS	Red S2 T2 I6
MATERIALS	Polycarbonate lens and housing
VOLT/AMP	12.8VDC - .375 Stop/Turn, .145A Tail
WT/DIMS	.38 lbs. / 5.48" x 5.48" x 1.53"
WARRANTY	Lifetime LED Warranty

Industry-standard connections

Easy retrofit of lights to existing harness

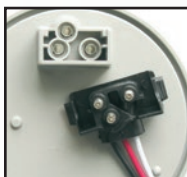

Standard PL3 connection



Weathertight connection

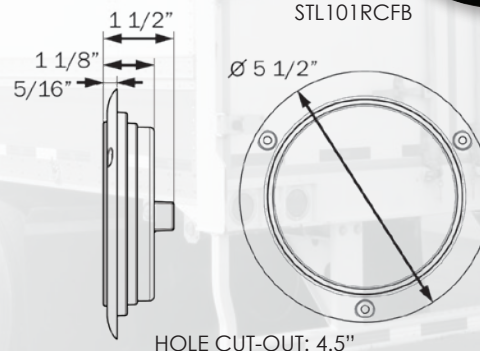

GloLight®

STOP/TURN

TAIL LIGHT

STL101RFB

STL101RCFB

LED SEALED STOP/TURN/TAIL & PARKING/TURN SIGNALS



STL43 SERIES 4" Round Sealed LED Lights

- Sonically sealed, waterproof
- Kits include grommet and plug
- Mount in any 360 degree position
- Available in 12-24V models
- Available with standard PL-3 or optional weathertight connection

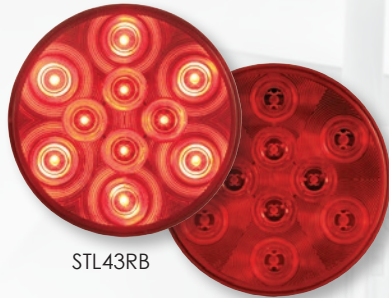

STL43RB



STL53RCB



STL43AB

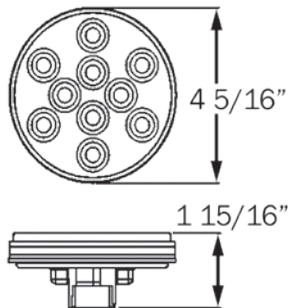

HOLE CUT-OUT: 4.5"

BULK P/N	POLYPACK P/N	DESCRIPTION	QTY
RED STOP/TURN/TAIL LIGHT - 10 DIODES			
STL43RB	STL43RBP	PL-3 connection, 12V	10
STL43RKB	STL43RKBP	Kit with A45GB & A47PB, PL-3, 12V	10
STL43R24B	STL43R24BP	PL-3 connection, 12-24V	10
STL43RMB	STL43RMBP	Weathertight connection, 12V	10
STL53RCB	STL53RCBP	Clear lens, red diode, PL-3, 12V	10
YELLOW PARKING/TURN SIGNAL - 10 DIODES			
STL43AB	STL43ABP	PL-3 connection, 12V	10
STL43A24B	STL43A24BP	PL-3 connection, 12-24V	10
STL43AKB	STL43AKBP	Kit with A45GB & A47PB, PL-3, 12V	10
ACCESSORIES			
A45GB	A45GBP	Grommet	50
A45PB	A45PBP	Pigtail, 3-wire PL-3	100
A47PB	A47PBP	Right angle pigtail, 3-wire PL-3	100
A45PMB	A45PMBP	Weathertight pigtail	100
AL45PWTB	AL45PWTBP	Weathertight to PL-3 adaptor	50
BK45BB	BK45BBP	Black steel bracket	10
A45BB	A45BBP	Black plastic flange	100
A45SB	A45SBP	Stainless steel mounting flange	20
A45CGB	A45CGBP	Chrome grommet cover	20
RETAIL			
STL43RK		12V kit with A45GB & A47PB, clam	6

FMVSS	Red S T I P2; Yellow I6 P
MATERIALS	Polycarbonate lens and housing
VOLT/AMP	Red: 12.8VDC - .360A Stop/Turn, .030A Tail Yellow: 12.8VDC - .310A Turn, .046A Parking
WT/DIMS	.265 lbs. / 4.313" x 4.313" x 1.938"
WARRANTY	Lifetime LED Warranty

STL42 SERIES

4" Round Sealed LED Lights with Mounting Flange

- Sonically sealed, waterproof
- Flange mount for security, theft reduction
- Available with standard PL-3 or optional weathertight connection

BULK P/N	POLYPACK P/N	DESCRIPTION	QTY
RED STOP/TURN/TAIL LIGHT - 10 DIODES			
STL42RB	STL42RBP	Black flange, PL-3	10
STL42RMB	STL42RMBP	Black flange, weathertight	10
YELLOW PARKING/TURN SIGNAL - 10 DIODES			
STL42AB	STL42ABP	Black flange, PL-3	10
STL42AMB	STL42AMB	Black flange, weathertight	10
ACCESSORIES			
A45PB	A45PBP	Pigtail, 3-wire PL-3	100
A47PB	A47PBP	Right angle pigtail, 3-wire PL-3	100
A45PMB	A45PMBP	Weathertight pigtail	100
AL45PWTB	AL45PWTBP	Weathertight to PL-3 adaptor	50
BK45BB	BK45BBP	Black steel bracket	10
A42FCB	A42FCBP	Chrome flange cover	100
A5TRSSB	A5TRSSBP	Stainless steel trim ring	100
A42GB	A42GBP	Mounting gasket, black	100
RETAIL			
STL42RS		Light only, clam	6

FMVSS	Red S T I P2; Yellow I6 P
MATERIALS	Polycarbonate lens and housing
VOLT/AMP	Red: 12.8VDC - .413 Stop/Turn, .026A Tail Yellow: 12.8VDC - .310 Turn, .046A Parking
WT/DIMS	.617 lbs. / 5.5" x 5.5" x 1.938"
WARRANTY	Lifetime LED Warranty



STL42RB



STL42AB



A42GB

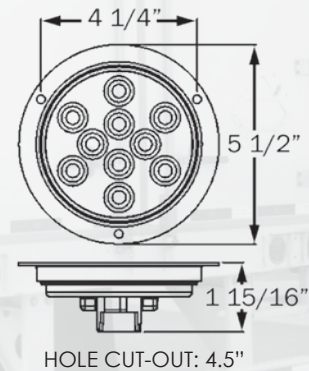

LED SEALED STOP/TURN/TAIL & PARKING/TURN SIGNALS



STL43 REFLEX FLANGE SERIES 4" Round Sealed LED Lights with Reflex Mounting Flange





STL43RBX



STL43ABX

- Sonically sealed, waterproof
- Flange mount for security, theft reduction
- Accepts standard PL-3 connector
- Reflex flange meets SAE A for reflector

BULK P/N	POLYPACK P/N	DESCRIPTION	QTY
RED STOP/TURN/TAIL LIGHT - 10 DIODES			
STL43RBX	STL43RBXP	Red reflex flange, gasket, PL-3	10
STL43RBHX	STL43RBHXP	Red reflex flange, hard wire, gasket	10
YELLOW PARKING/TURN SIGNAL - 10 DIODES			
STL43ABX	STL43ABXP	Yellow reflex flange, gasket, PL-3	10
ACCESSORIES			
A45PB	A45PBP	Pigtail, 3-wire PL-3	100
A47PB	A47PBP	Right angle pigtail, 3-wire PL-3	100
RETAIL			
STL43ABXS		Yellow light only, clam	6
STL43RBXS		Red light only, clam	6

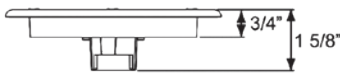
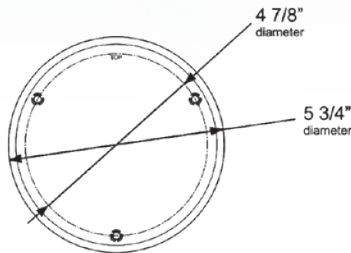

HOLE CUT-OUT: 4.5"

FMVSS	Red S T I; Yellow I6 P; Reflex A
MATERIALS	Polycarbonate lens and housing
VOLT/AMP	Red: 12.8VDC - .413 Stop/Turn, .026A Tail Yellow: 12.8VDC - .310 Turn, .046A Parking
WT/DIMS	.397 lbs. / 5.75" x 5.75" x 1.625"
WARRANTY	Lifetime LED Warranty

STL13 GROMMET MOUNT SERIES FLEET Count™ 4" Round Sealed LED Stop/Turn/Tail Lights

- Sonically sealed, waterproof
- Available with standard PL-3, male pin, weathertight or hard wired connections
- Retail kit includes grommet and plug

BULK P/N	POLYPACK P/N	DESCRIPTION	QTY
RED STOP/TURN/TAIL - 7 DIODES			
STL13RB	STL13RBP	PL-3 connection	10
STL13R1224B	STL13R1224BP	PL-3 connection, 12/24V	10
STL13RMB	STL13RMBP	Weathertight connection	10
STL13RGB	STL13RGBP	Male pin connection	10
STL13RH1B	STL13RH1BP	Hard wired, PL-3 female plug	10
STL13RH3B	STL13RH3BP	Hard wired, .180 male bullets	10
STL13RHBB	STL13RHBBP	Hard wired	10
STL13RLVB	STL13RLVBP	PL-3 connection, low-voltage cut-off at 9V	10
STL13RMB10GK	STL13RMB10GKP	Kit: STL13RMB and A45GB grommet	10
STL13RKB	STL13RKBP	Kit: STL13RB, with A45GB grommet and A45PB plug, PL-3 connection	10
YELLOW PARKING/TURN SIGNAL - 7 DIODES			
STL13AB	STL13ABP	PL-3 connection	10
ACCESSORIES			
A45GB	A45GBP	Grommet	50
A45PB	A45PBP	Pigtail, 3-wire PL-3	100
A47PB	A47PBP	Right angle pigtail, 3-wire PL-3	100
A45PMB	A45PMBP	Weathertight pigtail	100
AL45PWTB	AL45PWTBP	Weathertight to PL-3 adaptor	50
BK45BB	BK45BBP	Black steel bracket	10
A45BB	A45BBP	Black plastic flange	100
A45SB	A45SBP	Stainless steel flange	20
A45CGB	A45CGBP	Chrome grommet cover	20
RETAIL			
STL13RK		Kit with A45GB & A47PB, clam	6
STL13RS		Light only, clam	6
FMVSS	Red: S T I; Yellow: 16 P		
MATERIALS	Polycarbonate lens and housing		
VOLT/AMP	12.8VDC - .234A Stop/Turn, .033A Tail		
WT/DIMS	STL13 grommet mount: .265 lbs. / 4.31" x 4.31" x 1.81"		
WARRANTY	Lifetime LED Warranty		

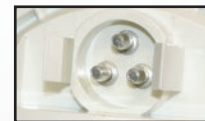
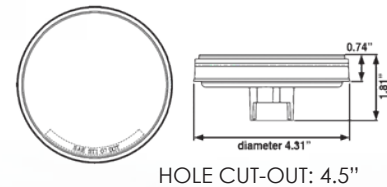

STL13RGB male pin connection

LED SEALED STOP/TURN/TAIL & PARKING/TURN SIGNALS



STL13 FLANGE MOUNT SERIES FLEET Count™ 4" Round Sealed LED Stop/Turn/Tail Lights



STL13RFB

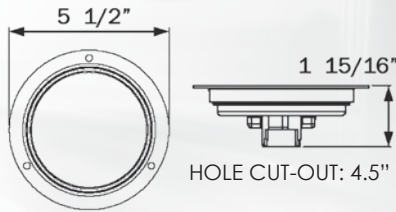

- Sonically sealed, waterproof
- Available with standard PL-3 and weathertight connections

BULK P/N	POLYPACK P/N	DESCRIPTION	QTY
RED STOP/TURN/TAIL - 7 DIODES			
STL13RFB	STL13RFBP	Flange, PL-3	10
STL13RFMB	STL13RFMBP	Flange, weathertight	10
ACCESSORIES			
A45PB	A45PBP	Pigtail, 3-wire PL-3	100
A47PB	A47PBP	Right angle pigtail, 3-wire PL-3	100
A45PMB	A45PMBP	Weathertight pigtail	100
AL45PWTB	AL45PWTBP	Weathertight to PL-3 adaptor	50
RETAIL			
STL13RFS	Retail Ready	Flange mount light only, clam	6

FMVSS	ST I
MATERIALS	Polycarbonate lens and housing
VOLT/AMP	12.8VDC - .234A Stop/Turn, .033A Tail
WT/DIMS	STL13 flange mount: .275 lbs. / 5.5" x 5.5" x 1.938"
WARRANTY	Lifetime LED Warranty



STL13RFHXB SERIES 4" Round Surface Mount Sealed LED Lights with Reflex

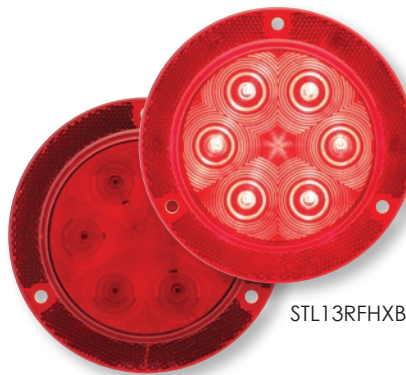

STL13RFHXB

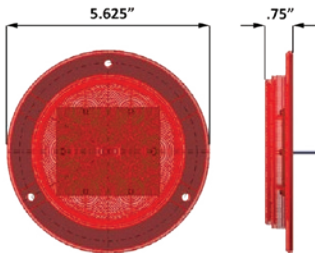

- Sonically sealed, waterproof
- Multi-function: stop/turn/tail with reflex flange - all in one light
- FMVSS compliant for under 80" applications
- Surface mount
- Hard wired

BULK P/N	POLYPACK P/N	DESCRIPTION	QTY
RED STOP/TURN/TAIL LIGHT - 7 DIODES			
STL13RFHXB	STL13RFHXP	Hard wired, with reflex	10
ACCESSORIES			
A42GB	A42GBP	Mounting gasket, black	100

FMVSS	ST I A
MATERIALS	Polycarbonate lens and housing
VOLT/AMP	12.8VDC - .234A Stop/Turn, .033A Tail
WT/DIMS	.38 lbs. / 5.625" x 5.625" x .75"
WARRANTY	Lifetime LED Warranty

STL413 SERIES FLEET Count™ 4" Round Sealed LED Lights

- Sonically sealed, waterproof
- Mount in any 360° position
- Available in standard PL-3 or optional weathertight connection

BULK P/N	POLYPACK P/N	DESCRIPTION	QTY
RED STOP/TURN/TAIL LIGHT - 4 DIODES			
STL413RB	STL413RBP	PL-3 connection	10
STL413RMB	STL413RMBP	Weathertight connection	10
ACCESSORIES			
A45GB	A45GBP	Grommet	50
A45PB	A45PBP	Straight pigtail, 3-wire PL-3	100
A47PB	A47PBP	Right angle pigtail, 3-wire PL-3	100
A45PMB	A45PMBP	Weathertight pigtail, 3-wire	50
AL45PWTB	AL45PWTBP	Weathertight pigtail to PL-3	50
A45BB	A45BBP	Black mounting flange	100
A45SB	A45SBP	Stainless steel mounting flange	20
BK45BB	BK45BBP	Black steel bracket	10
A45CGB	A45CGBP	Chrome grommet cover	20

FMVSS	S2 T2 I6
MATERIALS	Polycarbonate lens and housing
VOLT/AMP	12.8VDC - .160A Stop/Turn, .008A Tail
WT/DIMS	.265 lbs. / 4.313" x 4.313" x 1.625"
WARRANTY	Lifetime LED Warranty



STL413RB

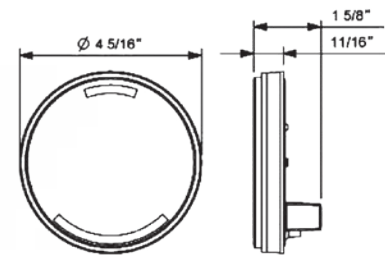

HOLE CUT-OUT: 4.5"

LED SEALED STOP/TURN/TAIL & PARKING/TURN SIGNALS

STL413RFHXB SERIES FLEET Count™ 4" Round Sealed LED Light with Reflex Flange

- Sonically sealed, waterproof
- FMVSS compliant for over/under 80" applications
- Surface mount, hard wired

BULK P/N	POLYPACK P/N	DESCRIPTION	QTY
RED STOP/TURN/TAIL LIGHT - 4 DIODES			
STL413RFHXB	STL413RFHXP	Hard wired, with reflex	10

FMVSS	S2 T2 I6 A
MATERIALS	Polycarbonate lens and housing
VOLT/AMP	12.8VDC - .160A Stop/Turn, .008A Tail
WT/DIMS	.25 lbs. / 5.625 x 5.625" x 0.75"
WARRANTY	Lifetime LED Warranty

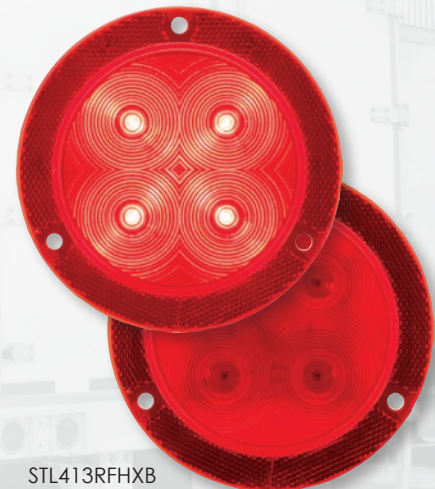

STL413RFHXB



STL003 SERIES

ONE™ LED 4" Round Sealed Lights

- Sonically sealed, waterproof
- Mount in any 360° position
- Available in grommet and flange mount models with PL-3 and weathertight connections



STL003RB



STL003AB



STL003RFLB



Locking PL-3 connection

BULK P/N	POLYPACK P/N	DESCRIPTION	QTY
----------	--------------	-------------	-----

RED STOP/TURN/TAIL LIGHT - 1 DIODE

STL003RB	STL003RBP	PL-3 connection	50
STL003R1224B	STL003R1224BP	PL-3 connection, 12V/24V	50
STL003RMB	STL003RMBP	Weathertight connection	50
STL003RFB	STL003RFBP	Flange mount, PL-3 connection	10
STL003RFLB	STL003RFLBP	Flange mount, locking PL-3 connection	10
STL003RFMB	STL003RFMBP	Flange mount, weathertight connection	10

YELLOW PARKING/TURN SIGNAL - 1 DIODE

STL003AB	STL003ABP	PL-3 connection	50
STL003A1224B	STL003A1224BP	PL-3 connection, 12V/24V	50

ACCESSORIES

A45GB	A45GBP	PVC grommet, flush mount	50
A45PB	A45PBP	Straight pigtail, 3-wire PL-3	100
A47PB	A47PBP	Right angle pigtail, 3-wire PL-3	100
AL45PWTB	AL45PWTBP	Weathertight pigtail, plug to female PL-3	50
A45PMB	A45PMBP	Weathertight 3-wire pigtail, plug to bare wire	50

For more details on mounting and wiring accessories, see Accessories section at back of catalog.

RETAIL

STL003RK		Kit with grommet and pigtail, clam	6
STL003RS		Light only, clam	6

FMVSS	Red: S T I, Yellow: I P
MATERIALS	Polycarbonate lens and housing
VOLT/AMP	12.8VDC - .25A Stop/Turn, .007A Tail 24.0VDC
WT/DIMS	Grommet mount: .35 lbs. / 4.313" x 4.313" (depth varies) Flange mount: .275 lbs. / 5.5" x 5.5" (depth varies)
WARRANTY	Lifetime LED Warranty

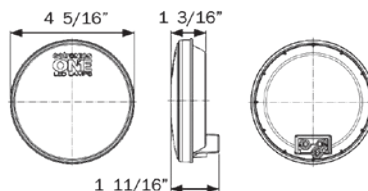

Grommet mount, PL-3

STL23 SERIES

Miro-Flex™ 4" Round Sealed LED Lights

- Sonically sealed, waterproof
- Mount in any 360 degree position
- Accepts standard PL-3 plugs
- Available in 12V and 24V models

BULK P/N	POLYPACK P/N	DESCRIPTION	QTY
RED STOP/TURN/TAIL - 12 DIODES			
STL23RB	STL23RBP	PL-3 connection, 12V	10
STL23CCRB	STL23CCRBP	Clear lens, red reflector, PL-3, 12V	10
STL23R24B	STL23R24BP	PL-3 connection, 24V	10
YELLOW PARKING/TURN SIGNAL - 16 DIODES			
STL23AB	STL23ABP	PL-3 connection, 12V	10
STL23A24B	STL23A24BP	PL-3 connection, 24V	10
ACCESSORIES			
A45GB	A45GBP	Grommet	50
A45PB	A45PBP	Pigtail, 3-wire PL-3	100
A47PB	A47PBP	Right angle pigtail, 3-wire PL-3	100
BK45BB	BK45BBP	Black steel bracket	10
A45BB	A45BBP	Black plastic flange	100
A45SB	A45SBP	Stainless steel flange	20
A45CGB	A45CGBP	Chrome grommet cover	20

FMVSS	Red S T I; Yellow I P
MATERIALS	Polycarbonate lens and housing
VOLT/AMP	Red: 12.8VDC - .208 Stop/Turn, .013A Tail 24.0VDC - .171 Stop/Turn, .061A Tail Yellow: 12.8VDC - .310 Turn, .046A Parking 24.0VDC - .171 Stop/Turn, .061A Tail
WT/DIMS	.265 lbs. / 4.313" x 4.313" x 1.938"
WARRANTY	Lifetime LED Warranty



STL23RB



STL23CCRB



STL23AB

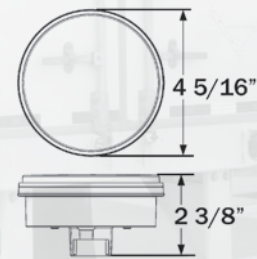

HOLE CUT-OUT: 4.5"

LED SEALED STOP/TURN/TAIL & PARKING/TURN SIGNALS

HYPERX®

STL543 SERIES HyperX® 4" Round Sealed LED Stop/Turn/Tail Light



STL543RB

- Sonically sealed, waterproof
- Mount in any 360 degree position
- Accepts standard PL-3 plugs
- 12 diodes and contemporary, automotive style optics

BULK P/N	POLYPACK P/N	DESCRIPTION	QTY
RED STOP/TURN/TAIL - 12 DIODES			
STL543RB	STL543RBP	PL-3 connection	10
ACCESSORIES			
A45GB	A45GBP	Grommet	50
A45PB	A45PBP	Pigtail, 3-wire PL-3	100
A47PB	A47PBP	Right angle pigtail, 3-wire PL-3	100
BK45BB	BK45BBP	Black steel bracket	10
A45BB	A45BBP	Black plastic flange	100
A45SB	A45SBP	Stainless steel flange	20
A45CGB	A45CGBP	Chrome grommet cover	20

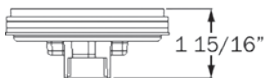
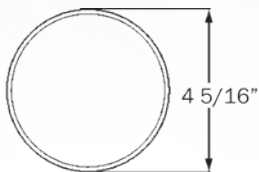

HOLE CUT-OUT: 4.5"

FMVSS	S T I
MATERIALS	Polycarbonate lens and housing
VOLT/AMP	12.8VDC - .208 Stop/Turn, .013A Tail
WT/DIMS	.265 lbs. / 4.313" x 4.313" x 1.938"
WARRANTY	Lifetime LED Warranty

STL55 SERIES

High LED Count 4" Round Sealed Lights for Recess Mount

- Sonically sealed, waterproof
- 21 LEDs for high diode count appearance
- Mount in any 360 degree position
- Accepts standard PL-3 plugs; red available with optional weathertight connection



STL55RB



STL55RFMB



STL55AB

BULK P/N	POLYPACK P/N	DESCRIPTION	QTY
RED STOP/TURN/TAIL - 21 DIODES			
STL55RB	STL55RBP	Grommet mount, PL-3 connection	10
STL55RMB	STL55RMBP	Flange mount, weathertight connection	10
STL55RFMB	STL55RFMBP	Flange mount, weathertight connection	10
YELLOW PARKING/TURN SIGNAL - 21 DIODES			
STL55AB	STL55ABP	Grommet mount, PL-3 connection	10
ACCESSORIES			
A45GB	A45GBP	Grommet	50
A45PB	A45PBP	Pigtail, 3-wire PL-3	100
A47PB	A47PBP	Right angle pigtail, 3-wire PL-3	100
A45PMB	A45PMBP	Weathertight pigtail	100
AL45PWTB	AL45PWTBP	Weathertight to PL-3 adaptor	50
BK45BB	BK45BBP	Black steel bracket	10
A45BB	A45BBP	Black plastic flange	100
A45SB	A45SBP	Stainless steel flange	20
A45CGB	A45CGBP	Chrome grommet cover	20

FMVSS	Red S T I; Yellow I6 P
MATERIALS	Polycarbonate lens and housing
VOLT/AMP	Red: 12.8VDC - .208 Stop/Turn, .013A Tail Yellow: 12.8VDC - .310 Turn, .046A Parking
WT/DIMS	Grommet mount: .265 lbs. / 4.313" x 4.313" x 1.5" Flange mount: .265 lbs. / 5.5" x 5.5" x 1.5"
WARRANTY	Lifetime LED Warranty

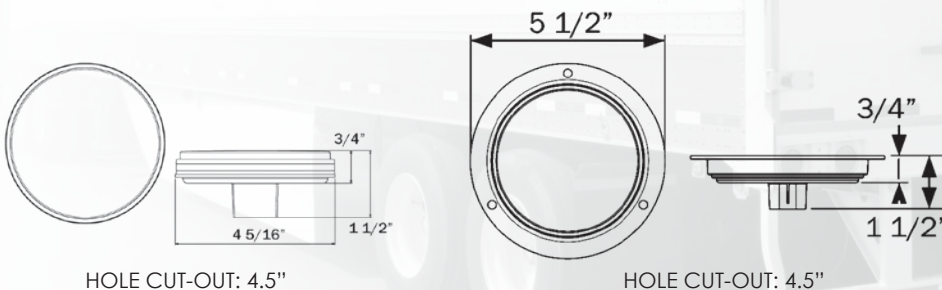

LED SEALED STOP/TURN/TAIL & PARKING/TURN SIGNALS



STL602 SERIES

LightGuide™ LED 6" Stop/Turn/Tail Light

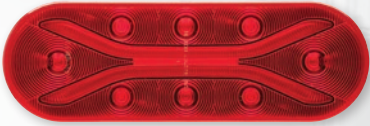
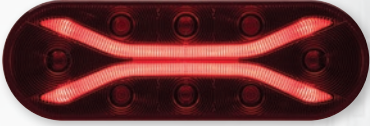
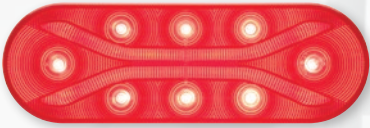

STL602RB

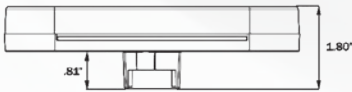
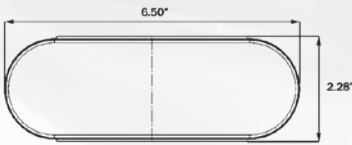

PATENTED TECHNOLOGY

- Central X-shaped feature illuminates for tail light function
- Surrounding diodes light for stop and turn functions
- Sonically sealed, waterproof
- Grommet mount
- Accepts industry standard PL-3 connector

BULK P/N	POLYPACK P/N	DESCRIPTION	QTY
RED STOP/TURN/TAIL LIGHT - 12 DIODES			
STL602RB	STL602RBP	PL-3 connection	10
ACCESSORIES			
A70GB	A70GBP	Grommet	50
A45PB	A45PBP	Pigtail, 3-wire	100
A47PB	A47PBP	Right angle pigtail, 3-wire	100
BK70BB	BK70BBP	Black steel bracket	10
A77S1B	A77S1BP	Gray, flat design steel bracket	50

FMVSS	S2 T2 I6
MATERIALS	Polycarbonate lens and housing
VOLT/AMP	12.8VDC - .421A Stop/Turn, .114A Tail
WT/DIMS	.375 lbs. / 6.5" x 2.28" x 1.80"
WARRANTY	Lifetime LED Warranty

STL111 GROMMET MOUNT SERIES GloLight® 6" Sealed LED Lights



PATENTED TECHNOLOGY

- Sonically sealed, waterproof
- Mount in any 360 degree position
- Available in tinted and clear lens models
- Available with standard PL-3 or optional weathertight connection

BULK P/N	POLYPACK P/N	DESCRIPTION	QTY
RED STOP/TURN/TAIL LIGHT - 22 DIODES			
STL111RB	STL111RBP	PL-3 connection	10
STL111R1224B	STL111R1224BP	PL-3 connection, 12/24V	10
STL111RMB	STL111RMBP	Weathertight	10
STL111RHB	STL111RHBP	Hard wired	10
STL111RCB	STL111RCBP	Clear lens, red diodes, PL-3	10
STL111RCMB	STL111RCMBP	Clear lens, red diodes, weathertight	10
YELLOW PARKING/TURN SIGNAL - 22 DIODES			
STL111AB	STL111ABP	PL-3	10
STL111ACB	STL111ACBP	Clear lens, yellow diodes, PL-3	10
ACCESSORIES			
A70GB	A70GBP	Grommet	50
A45PB	A45PBP	Pigtail, 3-wire	100
A47PB	A47PBP	Right angle pigtail, 3-wire	100
A45PMB	A45PMBP	Weathertight pigtail	100
AL45PWTB	AL45PWTBP	Weathertight to PL-3 adaptor	50
BK70BB	BK70BBP	Black steel bracket	10
A77S1B	A77S1BP	Gray, flat design steel bracket	50

RETAIL

TLL112RK		Try Me kit with (2) ea. STL111RB, A70GB and A47PB, clam	2
----------	--	--	---

FMVSS	Red S2 T2 I6; Yellow I6 P
MATERIALS	Polycarbonate lens and housing
VOLT/AMP	Red: 12.8VDC - .59A Stop/Turn, .295A Tail Yellow: 12.8VDC - .515A Turn, .27A Parking
WT/DIMS	.35 lbs. / 6.5" x 2.25" x 1.75"
WARRANTY	Lifetime LED Warranty

STOP/TURN



TAIL LIGHT

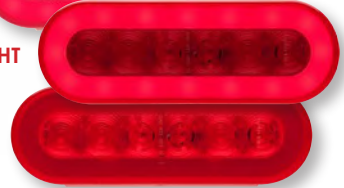

STL111RB

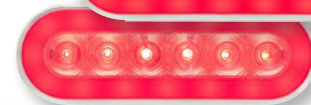

STL111RCB

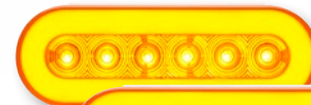

STL111AB



STL111ACB



TLL112RK

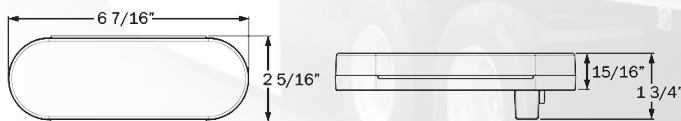

HOLE CUT-OUT: 6.85" X 2.5" (1.25" R)

LED SEALED STOP/TURN/TAIL & PARKING/TURN SIGNALS



STL111 FLANGE MOUNT SERIES GloLight® 6" Sealed LED Lights with Mounting Flange



TAIL
LIGHT



STOP/
TURN

STL111RFB



STL111RCFB

PATENTED TECHNOLOGY

- Sonically sealed, waterproof
- Recess flange mount for security, theft reduction
- Available in tinted and clear lens models
- Available with standard PL-3 or optional weathertight connection

BULK P/N	POLYPACK P/N	DESCRIPTION	QTY
RED STOP/TURN/TAIL LIGHT - 22 DIODES			
STL111RFB	STL111RFBP	PL-3 connection	10
STL111RFMB	STL111RFMBP	Weathertight connection	10
STL111RCFB	STL111RCFBP	Clear lens, red diodes, PL-3	10
STL111RCFMB	STL111RCFMBP	Clear lens, red diodes, weathertight	10
ACCESSORIES			
A45PB	A45PBP	Pigtail, 3-wire	100
A47PB	A47PBP	Right angle pigtail, 3-wire	100
A45PMB	A45PMBP	Weathertight pigtail	100
AL45PWTB	AL45PWTBP	Weathertight to PL-3 adaptor	50
BK70BB	BK70BBP	Black steel bracket	10
A77S1B	A77S1BP	Gray, flat design steel bracket	50
A111TRSSB	A111TRSSBP	Stainless steel trim ring	50

FMVSS	Red S2 T2 I6
MATERIALS	Polycarbonate lens and housing
VOLT/AMP	12.8VDC - .59 Stop/Turn, .295A Tail
WT/DIMS	.38 lbs. / 7.5" x 3.3" x 1.938"
WARRANTY	Lifetime LED Warranty

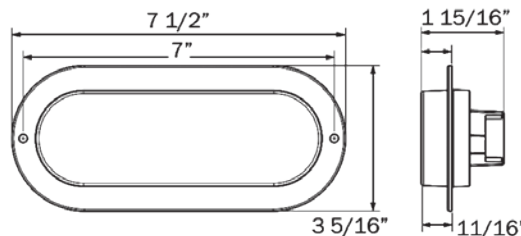

HOLE CUT-OUT: 6.85" X 2.5" (1.25" R)

STL178 SERIES

GloLight® 6" Sealed LED Stop/Turn/Tail Lights for Surface Mount

PATENTED TECHNOLOGY

- Sonically sealed, waterproof
- Mount in any 360 degree position
- Flange surface mount–no panel cut-out required
- Hard wired, with optional molded connectors
- Available in tinted and clear lens models

BULK P/N	POLYPACK P/N	DESCRIPTION	QTY
RED STOP/TURN/TAIL LIGHT - 22 DIODES			
STL178RB	STL178RBP	Hard wired	10
STL178RFPB	STL178RFPBP	Hard wired, female PL-3 plug	10
STL178RK1B	STL178RK1BP	Hard wired, EVA gasket	10
STL178RCCFPB	STL178RCCFPBP	Clear lens, red diodes, hard wired with female PL-3 connector	10
ACCESSORIES			
BK70BB	BK70BBP	Black steel bracket	10
A77S1B	A77S1BP	Gray, flat design steel bracket	50
A178TRSSB	A178TRSSBP	Stainless steel trim ring	50

FMVSS	S2 T2 I6
MATERIALS	Polycarbonate lens and housing
VOLT/AMP	12.8VDC - .59 Stop/Turn, .295A Tail
WT/DIMS	.38 lbs. / 7.5" x 3.3" x 1.1"
WARRANTY	Lifetime LED Warranty

GloLight®

TAIL LIGHT



STOP/TURN



STL178RB



STL178RCCFPB

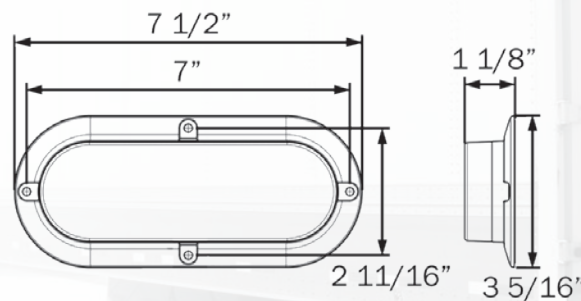

LED SEALED STOP/TURN/TAIL & PARKING/TURN SIGNALS

HD500 SERIES

STL512 SERIES HD500™ 6" Sealed LED Lights

- Sonically sealed, waterproof
- Mount in any 360° position
- Available in tinted and clear lens models

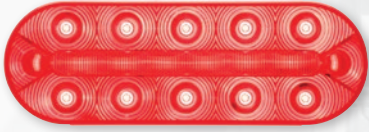

STL512RB

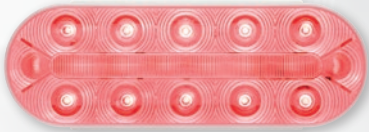

STL512RCB

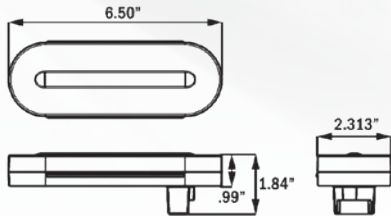

BULK P/N	POLYPACK P/N	DESCRIPTION	QTY
RED STOP/TURN/TAIL LIGHT - 18 DIODES			
STL512RB	STL512RBP	PL-3 connection	10
STL512RCB	STL512RCBP	Weathertight connection	10
ACCESSORIES			
A70GB	A70GBP	Grommet	50
A45PB	A45PBP	Pigtail, 3-wire	100
A47PB	A47PBP	Right angle pigtail, 3-wire	100
A77S1B	A77S1BP	Gray, flat design steel bracket	50
BK70BB	BK70BBP	Black steel bracket	10

FMVSS	S T I
MATERIALS	Polycarbonate lens and housing
VOLT/AMP	12.8VDC - .294A Stop/Turn, .024A Tail
WT/DIMS	.262 lbs. / 6.50" x 2.313" x 1.84"
WARRANTY	Lifetime LED Warranty

STL72/82 SERIES 6" Oval Sealed LED Lights

- Sonically sealed, waterproof
- Kits include grommet and plug
- Mount in any 360 degree position
- Available with standard PL-3 or optional weathertight connection

BULK P/N	POLYPACK P/N	DESCRIPTION	QTY
RED STOP/TURN/TAIL LIGHT - 10 DIODES			
STL72RB	STL72RBP	PL-3 connection	10
STL72R1224B	STL72R1224BP	PL-3 connection, 12V/24V	10
STL72RKB	STL72RKBP	Kit with A70GB, PL-3	10
STL74RBK	STL74RBKP	Kit with A70GB & A47PB, PL-3	50
STL74RKB	STL74RKBP	Kit with A70GB & A45PB, PL-3	10
STL72RMB	STL72RMBP	Weathertight connection	10
STL82RCB	STL82RCBP	Clear lens, red diodes, PL-3	10
YELLOW PARKING/TURN SIGNAL - 10 DIODES			
STL72AB	STL72ABP	PL-3	10
STL72AMB	STL72AMBP	Weathertight connection	10
STL72CAB	STL72CABP	Clear lens, amber diodes, PL-3	10
ACCESSORIES			
A70GB	A70GBP	Grommet	50
A45PB	A45PBP	Pigtail, 3-wire PL-3	100
A47PB	A47PBP	Right angle pigtail, 3-wire PL-3	100
A45PMB	A45PMBP	Weathertight pigtail	100
AL45PWTB	AL45PWTBP	Weathertight to PL-3 adaptor	50
BK70BB	BK70BBP	Black steel bracket	10
A77S1B	A77S1BP	Gray, flat design steel bracket	50
RETAIL			
STL72RK		12V kit with A70GB & A47PB, clam	6
STL72RS		12V, clam	6

FMVSS	Red S2 T2 I6; Yellow I6 P
MATERIALS	Polycarbonate lens and housing
VOLT/AMP	Red: 12.8VDC - .243A Stop/Turn, .046A Tail Yellow: 12.8VDC - .275A Turn, .042A Parking
WT/DIMS	.309 lbs. / 6.438" x 2.313" x 1.75"
WARRANTY	Lifetime LED Warranty



STL72RB

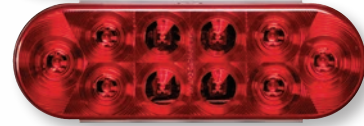

STL82RCB

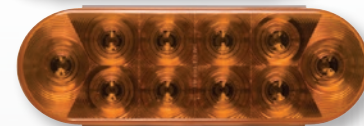

STL72AB

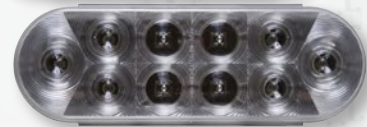

STL72CAB

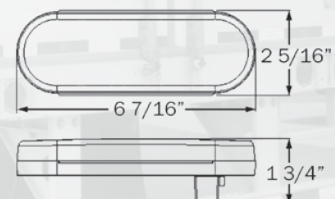

HOLE CUT-OUT: 6.85" X 2.5" (1.25" R)

LED SEALED STOP/TURN/TAIL & PARKING/TURN SIGNALS



STL78/88 SERIES 6" Oval Sealed LED Lights for Surface Mount

- Sonically sealed, waterproof
- Mount in any 360 degree position
- Flange surface mount—no panel cut-out required
- Hard wired, with optional molded connectors



STL78RB

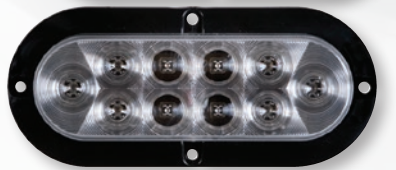

STL88RCB

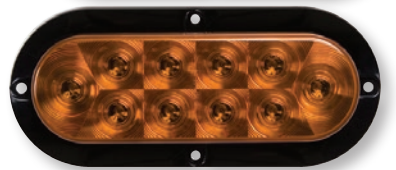

STL78AB

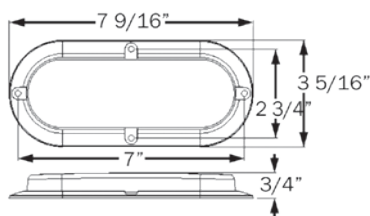

BULK P/N	POLYPACK P/N	DESCRIPTION	QTY
RED STOP/TURN/TAILO LIGHT - 10 DIODES			
STL78RB	STL78RBP	Hard wired	10
STL78RPG	STL78RPGP	.180 male bullets	10
STL78REZB	STL78REZBP	3-way female PL-3 plug	10
STL78RLPB	STL78RLPBP	Low profile 9/16" thick, female PL-3 plug, gasket included	10
STL88RCB	STL88RCBP	Clear lens, red diodes, hard wired	10
STL88RCPG	STL88RCPGP	Clear lens, red diodes, 3-way female PL-3 plug	10
STL88RC1PG	STL88RC1PGP	Clear lens, red diodes, hard wired .180 male bullets	10
STL88RCBPG	STL88RCBPBP	Clear lens, red diodes, hard wired .180 female bullets	10
YELLOW PARKING/TURN SIGNAL - 10 DIODES			
STL78AB	STL78ABP	Hard wired	10
ACCESSORIES			
A78CB1	A78CB1P	Chrome flange cover	25
A78RXB	A78RXBP	Red reflex flange cover & gasket	25
RETAIL			
STL78RK		Single light, clam	6

FMVSS	Red S2 T2 I6 P3; Yellow I6 P
MATERIALS	Polycarbonate lens and housing
VOLT/AMP	Red: 12.8VDC - .243A Stop/Turn, .046A Tail Yellow: 12.8VDC - .275A Turn, .042A Parking
WT/DIMS	STL78/88: .265 lbs. / 7.563" x 3.313" x 0.750" STL78RLPB: .260 lbs. / 7.563" x 3.313" x .563"
WARRANTY	Lifetime LED Warranty

STL12 SERIES

FLEET Count™ 6" Oval Sealed LED Stop/Turn/Tail Lights

- Sonically sealed, waterproof
- Available with standard PL-3 or optional weathertight connection
- Retail kit includes light, grommet and plug

BULK P/N	POLYPACK P/N	DESCRIPTION	QTY
RED STOP/TURN/TAIL - 6 DIODES			
STL12RB	STL12RBP	PL-3 connection	10
STL12R1224B	STL12R1224BP	PL-3 connection, 12/24V	10
STL12RMB	STL12RMBP	Weathertight connection	10
STL12RK2B	STL12RK2BP	Kit: STL12RB, A45PB, & A70GB	10
STL12RK2B	STL12RK2BP	Kit: STL12RB, A45PB, & A60GB	10
STL12RK3B	STL12RK3BP	Kit: STL12RB, A70GB	10
STL12RK4B	STL12RK4BP	Kit: STL12RB, A70GB, .156 female bullets	10
STL12RLVB	STL12RLVBP	PL-3 connection, low voltage cutoff at 9V	10
STL12RCB	STL12RCBP	Clear lens, red diodes, PL-3 connection	10
STL12RCKB	STL12RCKBP	Clear lens, red diodes kit: STL12RCB, A45PB, A70GB	10
YELLOW PARKING/TURN SIGNAL - 6 DIODES			
STL12AB	STL12ABP	PL-3 connection	10
ACCESSORIES			
A70GB	A70GBP	Grommet	50
A45PB	A45PBP	Pigtail, 3-wire PL-3	100
A47PB	A47PBP	Right angle pigtail, 3-wire PL-3	100
A45PMB	A45PMBP	Weathertight pigtail	100
AL45PWTB	AL45PWTBP	Weathertight to PL-3 adaptor	50
BK70BB	BK70BBP	Black steel bracket	10
A77S1B	A77S1BP	Gray, flat design steel bracket	50
A78CB1	A78CB1P	Chrome flange cover	25
A78RXB	A78RXBP	Red reflex flange cover & gasket	25
RETAIL			
STL12RK		Kit with A70GB & A47PB, clam	6
STL12RS		Light only, clam	6
TLL12RK		Kit with (2) each STL12RB, A70GB & A45PB, clam	2

FMVSS	Red: S T I; Yellow: I6 P
MATERIALS	Polycarbonate lens and housing
VOLT/AMP	12.8VDC - .161A Stop/Turn, .007A Tail
WT/DIMS	.375 lbs. / 6.5" x 2.25" x 1.75"
WARRANTY	Lifetime LED Warranty



STL12RB

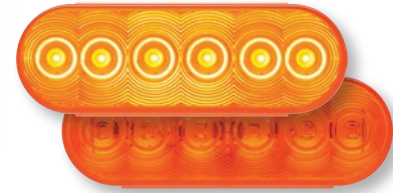

STL12AB

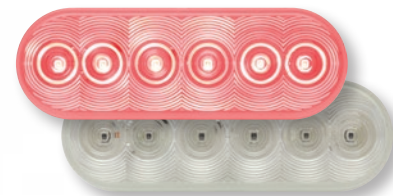

STL12RCB



TLL12RK

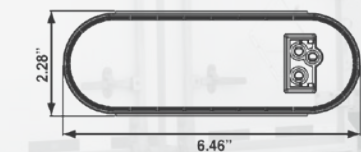

HOLE CUT-OUT: 6.85" X 2.5" (1.25" R)

LED SEALED STOP/TURN/TAIL & PARKING/TURN SIGNALS



STL73RB

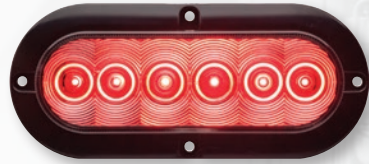

STL73RCB



A78CB1

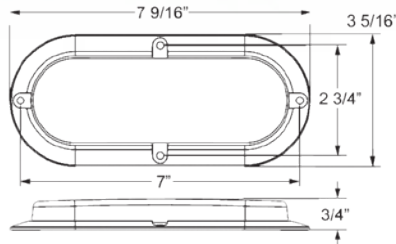

STL73 SERIES

FLEET Count™ 6" Oval Sealed LED Stop/Turn/Tail Lights

- Sonically sealed, waterproof
- Flange surface mount is hard wired requiring no panel cut-out; includes ground

BULK P/N	POLYPACK P/N	DESCRIPTION	QTY
RED STOP/TURN/TAIL - 6 DIODES			
STL73RB	STL73RBP	Flange surface mount, hard wired	10
STL73RKB	STL73RKBP	Light with A73GB gasket	100
STL73REZB	STL73REZBP	Flange surface mount, hard wired with PL-3 female plug	10
STL73RCB	STL73RCBP	Clear lens, red diodes, flange surface mount, hard wired	10
ACCESSORIES			
BK70BB	BK70BBP	Black steel bracket	10
A77S1B	A77S1BP	Gray, flat design steel bracket	50
A78CB1	A78CB1P	Chrome flange cover	25
A78RXB	A78RXBP	Red reflex flange cover & gasket	25
RETAIL			
STL73RK		Kit with STL73RB and A78CB1, clam	6

FMVSS	S T I
MATERIALS	Polycarbonate lens and housing
VOLT/AMP	12.8VDC - .161A Stop/Turn, .007A Tail
WT/DIMS	.287 lbs. / 7.563" x 3.263" x 0.75"
WARRANTY	Lifetime LED Warranty

STL412 SERIES FLEET Count™ 6" Sealed LED Lights

- Sonically sealed, waterproof
- Mount in any 360° position
- Accepts standard PL-3 connector

BULK P/N	POLYPACK P/N	DESCRIPTION	QTY
RED STOP/TURN/TAIL LIGHT - 4 DIODES			
STL412RB	STL412RBP	PL-3 connection	10
ACCESSORIES			
A70GB	A70GBP	Grommet	50
A45PB	A45PBP	Pigtail, 3-wire	100
A47PB	A47PBP	Right angle pigtail, 3-wire	100
BK70BB	BK70BBP	Black steel bracket	10
A77S1B	A77S1BP	Gray, flat design steel bracket	50
FMVSS	S T I		
MATERIALS	Polycarbonate lens and housing		
VOLT/AMP	12.8VDC - .161A Stop/Turn, .007A Tail		
WT/DIMS	.375 lbs. / 6.438" x 2.313" x 1.75"		
WARRANTY	Lifetime LED Warranty		

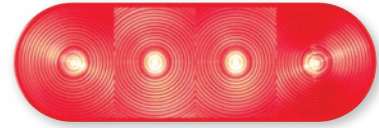

STL412RB

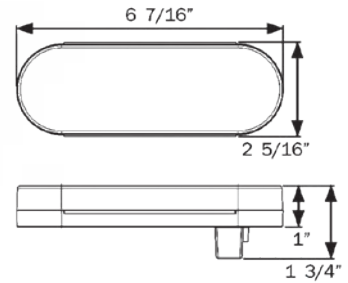

LED SEALED STOP/TURN/TAIL & PARKING/TURN SIGNALS



STL002 SERIES ONE™ LED 6" Sealed Lights

- Sonically sealed, waterproof
- Mount in any 360 degree position
- Available in grommet and flange mount models



STL002RB



STL002RFB



STL002AB



TLL002RK

BULK P/N	POLYPACK P/N	DESCRIPTION	QTY
RED STOP/TURN/TAIL LIGHT - 1 DIODE			
STL002RB	STL002RBP	PL-3 connection	50
STL002RK2B	STL002RK2BP	Kit with A60GB and A45PB, PL-3	10
STL002RMB	STL002RMBP	Weathertight connection	50
STL002RFB	STL002RFBP	Flange mount, PL-3 connection	10
YELLOW PARKING/TURN SIGNAL - 1 DIODE			
STL002AB	STL002ABP	PL-3 connection	50
ACCESSORIES			
A70GB	A70GBP	Grommet	50
A45PB	A45PBP	Pigtail, 3-wire PL-3	100
A47PB	A47PBP	Right angle pigtail, 3-wire PL-3	100
A45PMB	A45PMBP	Weathertight pigtail	100
AL45PWTB	AL45PWTBP	Weathertight to PL-3 adaptor	50
BK70BB	BK70BBP	Black steel bracket	10
A77S1B	A77S1BP	Gray, flat design steel bracket	50

RETAIL

STL002RK		Kit with grommet and plug, clam	6
STL002RS		Grommet mount light only, clam	6
TLL002RK		Set with (2) each STL002RB, A70GB and A47PB, clam	2

FMVSS	Red: S2 T2 I6, Yellow: I6 P
MATERIALS	Polycarbonate lens and housing
VOLT/AMP	12.8VDC - .25A Stop/Turn, .007A Tail
WT/DIMS	Grommet mount: .262 lbs. / 6.50" x 2.313" x 1.875" Flange mount: .262 lbs. / 7.563" x 3.313" x 1.125"
WARRANTY	Lifetime LED Warranty

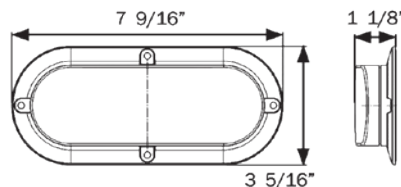
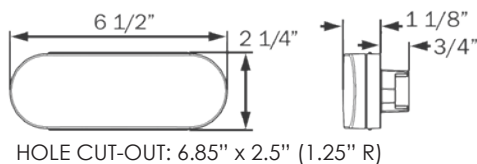

STL22 SERIES

Miro-Flex™ 6" Oval Sealed LED Lights

- Sonically sealed, waterproof
- Mount in any 360 degree position
- Accepts standard PL-3 plugs
- Available with tinted or clear lens and chrome or tinted reflector

BULK P/N	POLYPACK P/N	DESCRIPTION	QTY
RED STOP/TURN/TAIL - 12 DIODES			
STL22RB	STL22RBP	PL-3 connection	10
STL22RBH	STL22RBHP	Hard wired	10
STL22CCRB	STL22CCRBP	Clear lens, red reflector, PL-3	10
STL22RCB	STL22RCBP	Clear lens, PL-3	10
YELLOW PARKING/TURN SIGNAL - 16 DIODES			
STL22AB	STL22ABP	PL-3 connection	10
STL22CCAB	STL22CCABP	Clear lens, yellow reflector, PL-3	10
ACCESSORIES			
A70GB	A70GBP	Grommet	50
A45PB	A45PBP	Pigtail, 3-wire PL-3	100
A47PB	A47PBP	Right angle pigtail, 3-wire PL-3	100
BK70BB	BK70BBP	Black steel bracket	10
A77S1B	A77S1BP	Gray, flat design steel bracket	50

FMVSS	Red S T I; Yellow I P
MATERIALS	Polycarbonate lens and housing
VOLT/AMP	Red: 12.8VDC - .161 Stop/Turn, .009A Tail Yellow: 12.8VDC - .181 Turn, .023A Parking
WT/DIMS	.397 lbs. / 6.5" x 2.313" x 2.188"
WARRANTY	Lifetime LED Warranty

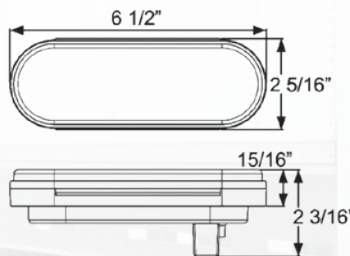

HOLE CUT-OUT:
6.85" X 2.5" (1.25" R)



STL22RB



STL22CCRB

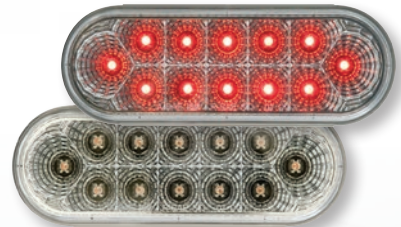

STL22RCB



STL22AB



STL22CCAB

LED SEALED STOP/TURN/TAIL & PARKING/TURN SIGNALS

HYPERX®



STL572RB



STL572AB

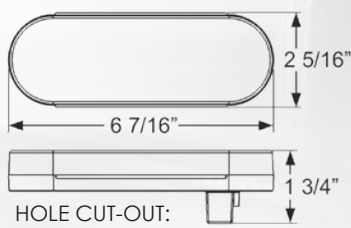

HOLE CUT-OUT:
6.85" X 2.5" (1.25" R)

STL572 SERIES HyperX® 6" Oval Sealed LED Lights

- Sonically sealed, waterproof
- Accepts standard PL-3 plugs

BULK P/N	POLYPACK P/N	DESCRIPTION	QTY
RED STOP/TURN/TAILO - 12 DIODES			
STL572RB	STL572RBP	PL-3 connection	10
YELLOW PARKING/TURN SIGNAL - 12 DIODES			
STL572AB	STL572ABP	PL-3 connection	10

FMVSS	Red S T I; Yellow I P
MATERIALS	Polycarbonate lens and housing
VOLT/AMP	Red: 12.8VDC - .174 Stop/Turn, .007A Tail Yellow: 12.8VDC - .261 Turn, .013A Parking
WT/DIMS	.331 lb. / 6.438" x 2.313" x 1.75"
WARRANTY	Lifetime LED Warranty

Optronics LED



STL70RB



STL70AB

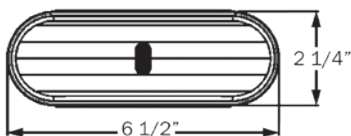

HOLE CUT-OUT: 6.85" X 2.5" (1.25" R)

STL70 SERIES High Diode Count 6" Oval Sealed LED Lights

- Sonically sealed, waterproof
- 48-56 LEDs for high diode count appearance
- Accepts standard PL-3 plugs



BULK P/N	POLYPACK P/N	DESCRIPTION	QTY
RED STOP/TURN/TAILO - 48 DIODES			
STL70RB	STL70RBP	PL-3 connection	10
YELLOW PARKING/TURN SIGNAL - 56 DIODES			
STL70AB	STL70ABP	PL-3 connection	10

FMVSS	Red S T I P2; Yellow I P2 P
MATERIALS	Polycarbonate lens and housing
VOLT/AMP	Red: 12.8VDC - .362 Stop/Turn, .013A Tail Yellow: 12.8VDC - .400 Turn, .046A Parking
WT/DIMS	.353 lbs. / 6.5" x 2.25" x 1.125"
WARRANTY	Lifetime LED Warranty

STL572 & STL70 ACCESSORIES			
A70GB	A70GBP	Grommet	50
A45PB	A45PBP	Pigtail, 3-wire PL-3	100
A47PB	A47PBP	Right angle pigtail, 3-wire PL-3	100
BK70BB	BK70BBP	Black steel bracket	10
A77S1B	A77S1BP	Gray, flat design steel bracket	50

STL175 SERIES

GloLight® 6" Oval Sealed LED E Rated Mid-Ship Turn Signal and Intermediate Marker Light

PATENTED TECHNOLOGY

- Sonically sealed, waterproof
- SAE "E" compliant—meets California requirements for mid-ship turn signal on vehicles 30 feet or longer
- Weathertight connection standard

BULK P/N	POLYPACK P/N	DESCRIPTION	QTY
E RATED - 10 DIODES			
STL175AMFB	STL175AMFBP	Weathertight connection	10
ACCESSORIES			
A45PMB	A45PMBP	Weathertight pigtail	100
AL45PWTB	AL45PWTBP	Weathertight to PL-3 adaptor	50
BK70BB	BK70BBP	Black steel bracket	10
A77S1B	A77S1BP	Gray, flat design steel bracket	50
A7TRSSB	A7TRSSBP	Stainless steel flange cover	20

FMVSS	E P2
MATERIALS	Polycarbonate lens and housing
VOLT/AMP	12.8VDC - .59 Stop/Turn, .11A Marker
WT/DIMS	.35 lbs. / 7.875" x 3.33" x 2.52"
WARRANTY	Lifetime LED Warranty

GloLight®



Marker



STL175AMFB Turn

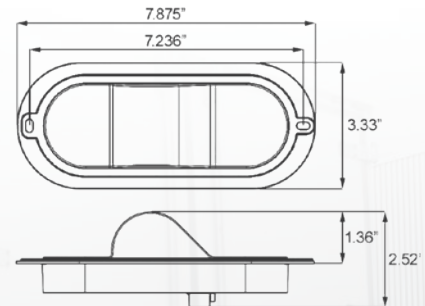

LED SEALED STOP/TURN/TAIL & PARKING/TURN SIGNALS



STL71/75 SERIES 6" Oval Sealed LED E Rated Mid-Ship Turn Signal and Intermediate Marker Light

- Sonically sealed, waterproof
- SAE "E" compliant—meets California requirements for mid-ship turn signal on vehicles 30 feet or longer
- Weathertight connection standard

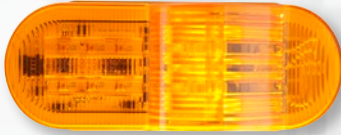
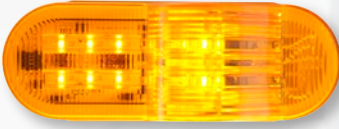

STL71AMB



HOLE CUT-OUT: 6.85" X 2.5" (1.25" R)



STL75AMFB

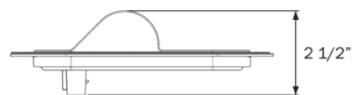
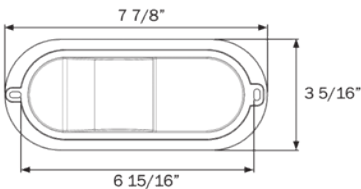

HOLE CUT-OUT: 6.85" X 2.5" (1.25" R)

BULK P/N	POLYPACK P/N	DESCRIPTION	QTY
E RATED - 10 DIODES			
STL71AMB	STL71AMBP	Weathertight connection	10
STL71AKMB	STL71AKMBP	Kit: STL71AMB, A70GB	10
STL75AMFB	STL75AMFBP	Flange, weathertight connection	10
ACCESSORIES			
A70GB	A70GBP	Grommet	50
A45PMB	A45PMBP	Weathertight pigtail	100
AL45PWTB	AL45PWTBP	Weathertight to PL-3 adaptor	50
BK70BB	BK70BBP	Black steel bracket	10
A77S1B	A77S1BP	Gray, flat design steel bracket	50
A7TRSSB	A7TRSSBP	Stainless steel flange cover	20

FMVSS E P2

MATERIALS Polycarbonate lens and housing

VOLT/AMP 12.8VDC - .201A Turn, .054 Marker

WT/DIMS Grommet Mount: .309 lbs. / 6.5" x 2.375" x 2.5"

Flange Mount: .309 lbs. / 7.875" x 3.313" x 2.5"

WARRANTY Lifetime LED Warranty

STL75 SERIES

6" Oval Sealed LED E2 Rated Mid-Ship Turn Signal and Intermediate Marker Light

- Sonically sealed, waterproof
- "E2" rated for vehicles less than 30 feet in length
- Available with standard PL-3 or optional weathertight connection



STL75AB

BULK P/N	POLYPACK P/N	DESCRIPTION	QTY
E2 RATED - 9 DIODES			
STL75AB	STL75ABP	PL-3 connection	10
STL75AMB	STL75AMB	Weathertight connection	10
ACCESSORIES			
A70GB	A70GBP	Grommet	50
A45PB	A45PBP	Pigtail, 3-wire PL-3	100
A47PB	A47PBP	Right angle pigtail, 3-wire PL-3	100
A45PMB	A45PMBP	Weathertight pigtail	100
AL45PWTB	AL45PWTBP	Weathertight to PL-3 adaptor	50
BK70BB	BK70BBP	Black steel bracket	10
A77S1B	A77S1BP	Gray, flat design steel bracket	50
RETAIL			
STL75AS		Single light, clam	6

FMVSS	A E2 P2
MATERIALS	Polycarbonate lens and housing
VOLT/AMP	12.8VDC - .141A Turn, .060 Marker
WT/DIMS	PL-3 Connection: .309 lbs. / 6.5" x 2.313" x 2.75" Weathertight: .309 lbs. / 6.5" x 2.313" x 2.58"
WARRANTY	Lifetime LED Warranty

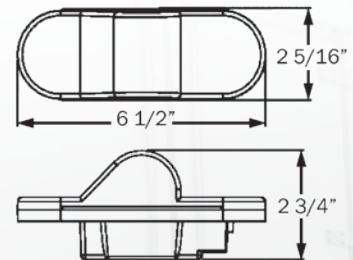

HOLE CUT-OUT: 6.85" X 2.5" (1.25" R)

LED SEALED STOP/TURN/TAIL & PARKING/TURN SIGNALS



STL33 SERIES Sealed Rectangular LED Stop/Turn/Tail Lights

- Sonically sealed, waterproof
- Accepts standard PL-3 plugs



STL33RB

BULK P/N	POLYPACK P/N	DESCRIPTION	QTY
RED STOP/TURN/TAIL - 12 DIODES			
STL33RB	STL33RBP	Grommet mount, PL-3 connection	10
STL34RB	STL34RBP	Kit: STL33RB, A33GB & A45PB	10
ACCESSORIES			
A33GB	A33GBP	Grommet	50
A45PB	A45PBP	Pigtail, 3-wire PL-3	100
A47PB	A47PBP	Right angle pigtail, 3-wire PL-3	100

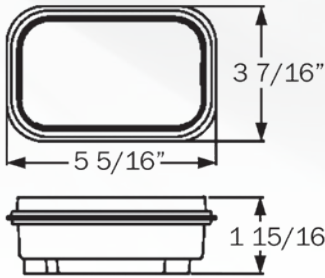

STL33RB

HOLE CUT-OUT: 5.453" X 3.578" (1" R)

FMVSS	S2 T2 I6
MATERIALS	Polycarbonate lens and housing
VOLT/AMP	12.8VDC - .405 Stop/Turn, .038A Tail
WT/DIMS	.309 lbs. / 5.313" x 3.438" x 1.938"
WARRANTY	Lifetime LED Warranty

STL35 SERIES Sealed Rectangular LED Lights

- Sonically sealed, waterproof
- Accepts standard PL-3 plugs
- Available in red and amber
- Miro-Flex™ combines smooth lens and faceted reflector design for a contemporary automotive appearance

BULK P/N	POLYPACK P/N	DESCRIPTION	QTY
RED STOP/TURN/TAIL - 16 DIODES			
STL35RB	STL35RBP	PL-3 connection	10
STL24RB	STL24RBP	PL-3 connection, 12-24V	10
STL35CCRB	STL35CCRBP	Clear lens, red diodes, PL-3 connection	10
YELLOW PARKING/TURN SIGNAL - 16 DIODES			
STL35AB	STL35ABP	PL-3 connection	10
STL24AB	STL24ABP	PL-3 connection, 12-24V	10
STL35ACB	STL35ACBP	Clear lens, yellow diodes, PL-3 connection	10
ACCESSORIES			
A33GB	A33GBP	Grommet	50
A45PB	A45PBP	Pigtail, 3-wire PL-3	100
A47PB	A47PBP	Right angle pigtail, 3-wire PL-3	100

FMVSS	STL35RB:	S2 T2 I6
	STL35AB:	I6 P
MATERIALS	Polycarbonate lens and housing	
VOLT/AMP	STL35RB:	12.8VDC - .301 Stop/Turn, .020A Tail
	STL35AB:	12.8VDC - .301 Turn, .020A Parking
WT/DIMS	.309 lbs. / 5.313" x 3.438" x 2.313"	
WARRANTY	Lifetime LED Warranty	

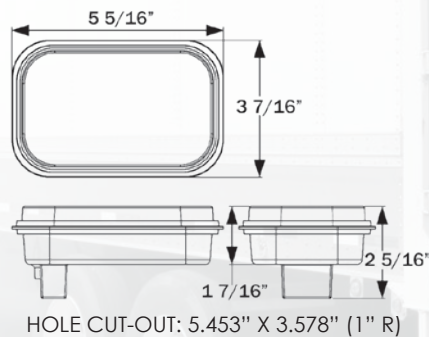

STL35RB



STL35CCRB



STL35AB



STL35ACB

LED SEALED STOP/TURN/TAIL & PARKING/TURN SIGNALS



STL63 SERIES

Thinline LED Stop/Turn/Tail Lights



STL63RB

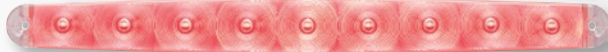

STL63CRB

- Sonically sealed, waterproof
- Low profile design—only 5/8" thick
- Surface mount on 14-1/8" centers
- Hard wired with separate ground wire
- Available with tinted or clear lens

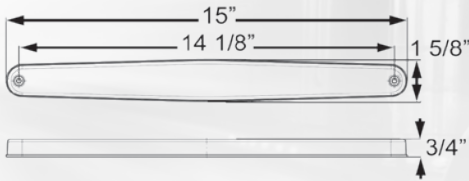

BULK P/N	POLYPACK P/N	DESCRIPTION	QTY
----------	--------------	-------------	-----

RED STOP/TURN/TAIL LIGHTS - 9 DIODES

STL63RB	STL63RBP	Red	10
STL63CRB	STL63CRBP	Clear lens, red diodes	10

FMVSS	ST I
MATERIALS	Polycarbonate lens and housing
VOLT/AMP	12.8VDC - .350 Stop/Turn, .022A Tail
WT/DIMS	.275 lbs. / 15" x 1.625" x .75"
WARRANTY	Lifetime LED Warranty

STL69 SERIES Thinline Sealed LED Stop/Turn/Tail Lights

- Sonically sealed, waterproof
- Low profile design—only 5/8" thick
- Surface mount on 14-1/8" centers; optional gasket
- STL69RRXB meets SAE S2T216 for over 80" wide vehicles and has built-in reflex meeting SAE A
- Hard wired with separate ground wire; available with optional molded plugs



STL69RB



STL69RCB



STL69RRXB

BULK P/N	POLYPACK P/N	DESCRIPTION	QTY
RED STOP/TURN/TAIL LIGHTS - 11 DIODES			
STL69RB	STL69RBP	Red, hard wired	10
STL69RPG	STL69RPGP	Red, .180 molded bullets	10
STL69R2PG	STL69R2PGP	Red, .156 molded barrels	10
STL69RCB	STL69RCBP	Clear lens, red diodes	10
STL69CRPG	STL69CRPGP	Clear lens, red diodes, .180 male bullets	10
STL69RRXB	STL69RRXBP	Built-in reflex	10
STL69RRXBPG	STL69RRXBPGP	Red, hard wired, .156 female barrels	10
STL69RRXP	STL69RRXP	Red, hard wired .180 male bullets	10
ACCESSORIES			
A69GB	A69GBP	Gasket	10
A69CB	A69CBP	Chrome base for STL69	10
A69XCB	A69XCBP	Chrome base for STL69RRXB	10
RETAIL			
STL69RS		STL69RB light only, clam	6
STL69RK		STL69RB with A69CB, clam	6
STL69RRXCS		STL69RRXB with A69XCB, clam	6

FMVSS	STL69: S T I	
	STL69RRXB: S2 T2 I6 A	
MATERIALS	Polycarbonate lens and housing	
VOLT/AMP	STL69: .350A Stop, .022 Tail	
	STL69RRXB: .161A Stop, .013A Tail	
WT/DIMS	STL69: .441 lbs. / 15" x 1.375" x .625"	
	STL69RRXB: .445 lbs. / 15" x 1.625" x .625"	
WARRANTY	Lifetime LED Warranty	

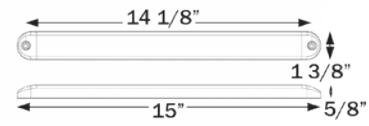

STL69RB/RCB

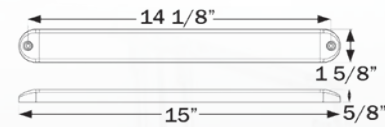

STL69RRXB

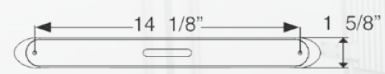

A69CB

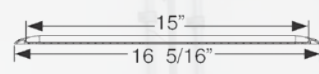

A69XCB

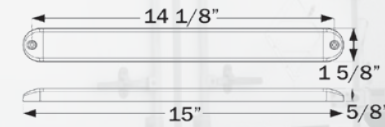

LED COMBINATION
TAIL LIGHTS & KITS



STL179 SERIES GloLight® Streamline LED Light



TAIL LIGHT

STOP/TURN

STL179RB

PATENTED TECHNOLOGY

- Sonically sealed, waterproof
- Low profile design—only 1-3/8" high x 1" thick
- Surface mount on 16-1/8" centers
- Hard wired with separate ground wire

BULK P/N	POLYPACK P/N	DESCRIPTION	QTY
RED STOP/TURN/TAIL - 28 DIODES			
STL179RB	STL179RBP	Stop/turn/tail light	10
ACCESSORIES			
A79CB	A79CBP	Chrome mounting base	10



A79CB

FMVSS	S T I
MATERIALS	Polycarbonate lens and housing
VOLT/AMP	12.8VDC - .634 Stop/Turn, .445A Tail
WT/DIMS	.353 lbs. / 17" x 1.375" x 1"
WARRANTY	Lifetime LED Warranty

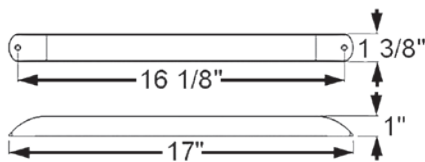

STL179RB

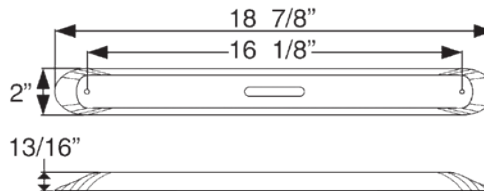

A79CB

STL79 SERIES

Streamline Sealed LED Lights



LED COMBINATION
TAIL LIGHTS & KITS



STL79RB/80RB



STL89RCB

- Sonically sealed, waterproof
- Low profile design—only 1-3/8" high x 1" thick
- Surface mount on 16-1/8" centers
- Available as stop/turn/tail lights and third brake lights
- Hard wired with separate ground wire

BULK P/N	POLYPACK P/N	DESCRIPTION	QTY
RED STOP/TURN/TAIL - 11 DIODES			
STL79RB	STL79RBP	Stop/turn/tail light, hard wired	10
STL79RPG	STL79RPGP	Stop/turn/tail light, .180 male bullets	10
STL80RB	STL80RBP	Third brake light, hard wired	10
STL89RCB	STL89RCBP	Clear lens stop/turn/tail light, hard wired	10
ACCESSORIES			
A79CB	A79CBP	Chrome mounting base	10
RETAIL			
STL79RS		Stop/turn/tail light, clam	6

FMVSS	STL79/89: S T I
	STL80: U
MATERIALS	Polycarbonate lens and housing
VOLT/AMP	STL79/89: 12.8VDC - .350 Stop/Turn, .022A Tail
	STL80: 12.8VDC - .216 Stop
WT/DIMS	.353 lbs. / 17" x 1.375" x 1"
WARRANTY	Lifetime LED Warranty

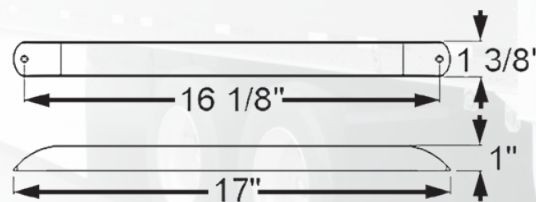



STL76 SERIES

Thinline Sealed LED
Stop/Turn/Tail Light for Over 80"
Wide Applications

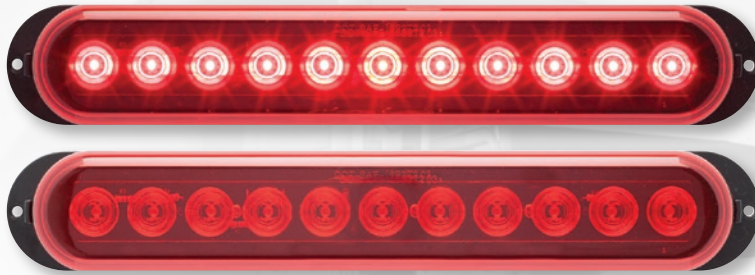

STL76RB

PATENTED TECHNOLOGY

- Replaceable, snap-on red lens
- Clear lens sonically sealed to housing making light completely waterproof
- Surface mount on 12-7/8" centers
- Meets SAE S2T2I6 for over 80" wide vehicles
- Hard wired with separate ground wire

BULK P/N	POLYPACK P/N	DESCRIPTION	QTY
RED STOP/TURN/TAIL LIGHT - 11 DIODES			
STL76RB	STL76RBP	Stop/turn/tail light	10

FMVSS	S2 T2 I6
MATERIALS	Polycarbonate lens and housing
VOLT/AMP	12.8V / .275A Stop, .022A Tail
WT/DIMS	.529 lbs. / 13.26" x 2.13" x 1.42"
WARRANTY	Lifetime LED Warranty

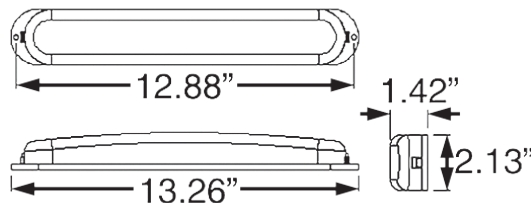

STL59 SERIES Thinline Sealed LED Stop/Turn/Tail Lights

- Sonically sealed, waterproof
- Low profile design—only 1/2" thick
- Surface mount on 11-3/4" centers
- Hard wired with separate ground wire

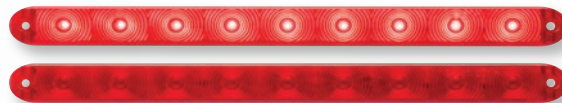

STL59RB

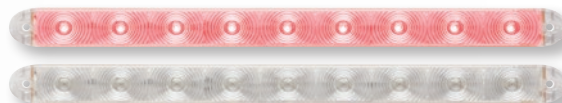

STL59RCB

BULK P/N	POLYPACK P/N	DESCRIPTION	QTY
RED STOP/TURN/TAIL LIGHTS - 9 DIODES			
STL59RB	STL59RBP	Red, hard wired	10
STL59RCB	STL59RCBP	Clear lens, red, hard wired	10

FMVSS	S T I
MATERIALS	Polycarbonate lens and housing
VOLT/AMP	12.8VDC - .2A Stop, .01A Tail
WT/DIMS	.441 lbs. / 12.625" x 1" x .5"
WARRANTY	Lifetime LED Warranty

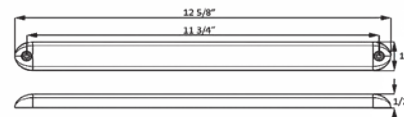

LED COMBINATION
TAIL LIGHTS & KITS



STL64 SERIES Thinline Sealed LED Stop/Turn/Tail Lights



STL64RB



STL64RCB

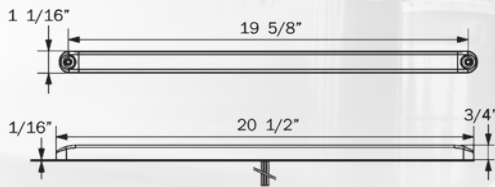

- Sonically sealed, waterproof
- Low profile design—only 3/4" thick
- Surface mount on 19-5/8" centers
- Hard wired with separate ground wire

BULK P/N	POLYPACK P/N	DESCRIPTION	QTY
RED STOP/TURN/TAIL - 15 DIODES			
STL64RB	STL64RBP	Red, hard wired	10
STL64RCB	STL64RCBP	Clear lens, red diodes, hard wired	10
ACCESSORIES			
A64CRB	A64CRBP	Chrome bezel	50
A64BB	A64BBP	Black bezel	50

FMVSS	S2 T2 I6
MATERIALS	Polycarbonate lens and housing
VOLT/AMP	12.8VDC - .2A Stop, .01A Tail
WT/DIMS	.441 lbs. / 20.5" x 1" x .75"
WARRANTY	Lifetime LED Warranty

STL87 SERIES Thinline Sealed LED Stop/Turn/Tail Lights

- Sonically sealed, waterproof
- Low profile design—only 5/8" thick
- Surface mount on 14-9/16" centers
- Hard wired with separate ground wire

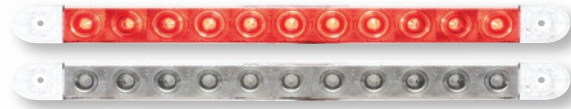

STL87RCB

LED COMBINATION
TAIL LIGHTS & KITS

BULK P/N	POLYPACK P/N	DESCRIPTION	QTY
RED STOP/TURN/TAIL LIGHTS - 11 DIODES			
STL87RCB	STL87RCBP	Clear lens, red diodes	10
STL87RCPG	STL87RCPGP	Clear lens, red diodes .180 male bullets	10

FMVSS	S2 T2 I6
MATERIALS	Polycarbonate lens and housing
VOLT/AMP	12.8VDC - .2A Stop, .01A Tail
WT/DIMS	.441 lbs. / 16.188" x 1.25" x .688"
WARRANTY	Lifetime LED Warranty

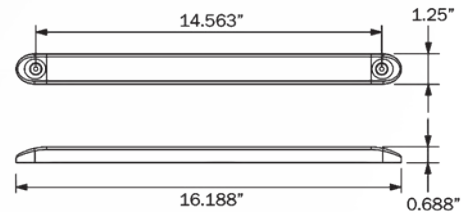



STL153 SERIES GloLight® LED Dual Face Pedestal Mount Lights



STL153ARPBB



STL153ARDBB



PATENTED TECHNOLOGY

- 25 LEDs per side
- Ring illuminates for tail light function; inner LEDs light and ring brightens for brake/turn
- Includes built-in 3-LED yellow side marker with reflex
- Hard wired, includes separate ground wire

BULK P/N	POLYPACK P/N	DESCRIPTION	QTY
		DUAL FACE RED	YELLOW - 25 DIODES
STL153ARDBB	STL153ARDBBP	Driver side	10
STL153ARPBB	STL153ARPBBP	Passenger side	10

FMVSS	S2 T2 I6, I6 P, A P2
MATERIALS	Chrome plastic housing, acrylic lens
VOLT/AMP	12.8V / .360A Stop, .030A Tail
WT/DIMS	1.477 lbs. / 4.688" x 4.875" x 2.438"
WARRANTY	Lifetime LED Warranty

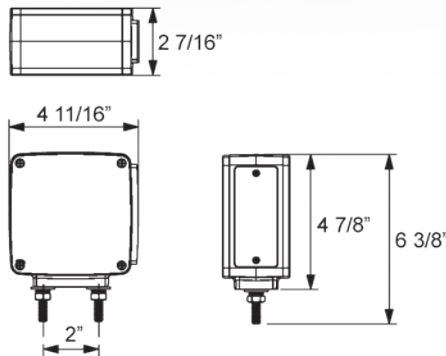

STL52/53 SERIES LED Pedestal Mount Lights

- Lead wires exit through mounting post; separate ground wire
- 21 LEDs per side
- STL53 available in driver and passenger side models with built-in yellow side marker with reflex



STL52ARB



STL52ARB
profile

BULK P/N	POLYPACK P/N	DESCRIPTION	QTY
		DUAL FACE RED YELLOW - 42 DIODES	
STL52ARB	STL52ARBP	Round	10
STL53ARPB	STL53ARPBP	Square, passenger side	10
STL53ARDB	STL53ARDBP	Square, driver side	10
RETAIL			
STL52ARS		Round, clam	6

FMVSS	STL52:	S T I P
	STL53:	Tail S T I P, Side Marker A P 2
MATERIALS	STL52:	Die cast housing, polycarbonate lens
	STL53:	Polycarbonate lens and housing
VOLT/AMP	STL52:	12.8VDC - .360 Stop/Turn, .030A Tail
	STL53:	12.8VDC - .750 Stop/Turn, .114A Tail
WT/DIMS	STL52:	1.477 lbs. / 4.25" x 4.25" x 1.938"
	STL53:	.882 lb. / 4.5" x 4.75" x 2.25"
WARRANTY	Lifetime LED Warranty	



STL53ARPB

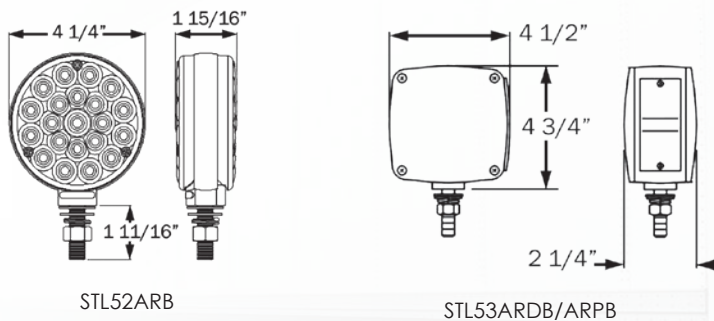

GloLight

STL190 SERIES GloLight® 7" LED Transit Lights

PATENTED TECHNOLOGY

- Sonically sealed, waterproof
- Surface mount light with mounting gasket
- Built-in reflector meets reflex requirement "A"
- Hard wired with separate ground wire



STOP/
TURN

STL190RB



TAIL
LIGHT



TURN

STL190AB

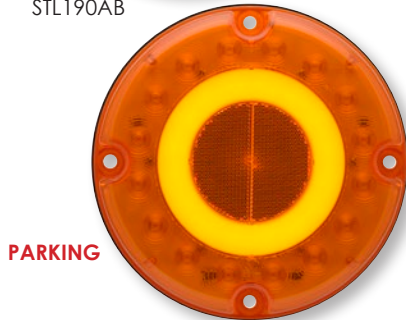

PARKING

BULK P/N	POLYPACK P/N	DESCRIPTION	QTY
RED STOP/TURN/TAIL LIGHT - 32 DIODES			
STL190RB	STL190RBP	Stop/turn/tail light	5
STL190RPG	STL190RPGP	Stop/turn/tail light, amp plug	5
YELLOW PARKING/TURN SIGNAL - 32 DIODES			
STL190AB	STL190ABP	Parking/turn signal	5

FMVSS	Red S2 I6 T2 P2 A; Yellow I6 P2 A
MATERIALS	Polycarbonate lens and housing
VOLT/AMP	Red: 12.8VDC - .340A Stop/Turn, .135A Tail Yellow: 12.8VDC - .410A Turn, .072A Parking
WT/DIMS	.970 lb. / 7" x 7" x 1.625"
WARRANTY	Lifetime LED Warranty

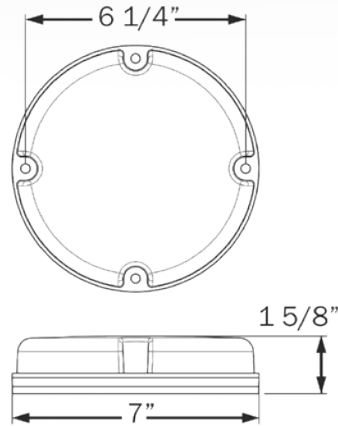

STL90 SERIES 7" Round LED Transit Lights

- Sonically sealed, waterproof
- Surface mount light with mounting gasket
- Built in reflector meets reflex requirement "A"
- Hard wired with separate ground wire
- Available in 12V and 12-24V models

BULK P/N	POLYPACK P/N	DESCRIPTION	QTY
RED STOP/TURN/TAIL LIGHT - 31 DIODES			
STL90RB	STL90RBP	Stop/turn/tail light, 12V	5
STL90R24B	STL90R24BP	Stop/turn/tail light, 12-24V	5
YELLOW TURN SIGNAL - 31 DIODES			
STL90AB	STL90ABP	Parking/turn signal, 12V	5
STL90A24B	STL90A24BP	Parking/turn signal, 12-24V	5

FMVSS	Red S2 I6 T2 P2 A; Yellow I6 P2 A
MATERIALS	Polycarbonate lens and housing
VOLT/AMP	Red: 12.8VDC - .243A Stop/Turn, .046A Tail Yellow: 12.8VDC - .275A Turn, .042A Parking
WT/DIMS	.970 lb. / 7" x 7" x 1.438"
WARRANTY	Lifetime LED Warranty

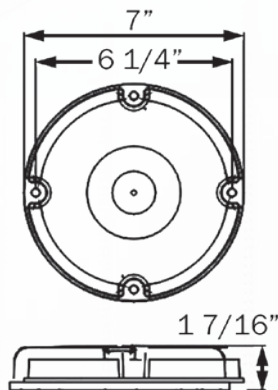

STL90RB

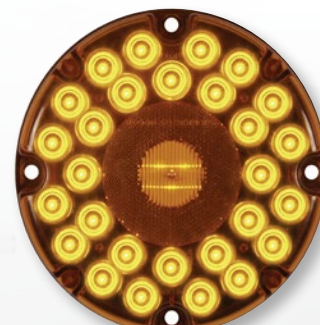

STL90AB

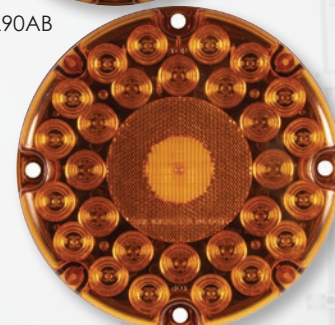

LED COMBINATION
TAIL LIGHTS & KITS

GloLight®

STL161 SERIES

GloLight® LED Combination Tail Lights



TAIL LIGHT



STOP/TURN/BACK-UP



STL161RB

PATENTED TECHNOLOGY

- Stud mount stop/turn/tail light with built-in back-up light and reflex
- 30-LED tail light; 6-LED back-up light
- Driver side light also includes 3-LED license light
- Hard wired; wire exits through back of housing
- Includes ground wire

BULK P/N	POLYPACK P/N	DESCRIPTION	QTY
----------	--------------	-------------	-----

GLOLIGHT® COMBINATION TAIL LIGHTS - 36 DIODES

STL161RB	STL161RBP	Passenger side, 30-LED tail, 6-LED back-up	5
STL161RLB	STL161RLBP	Driver side with 3-LED license light	5

FMVSS STL161RB: A 16 (2)R S2 (3)T
STL161RLB: A 16 (2)R S2 (3)T L

MATERIALS Acrylic lens, plastic housing

VOLT/AMP 12.8VDC - Tail .19A, Stop/Turn .30A, Back-up .21A

WT/DIMS .882 lb. / 5.813" x 6.75" x 2.688"

WARRANTY Lifetime LED Warranty

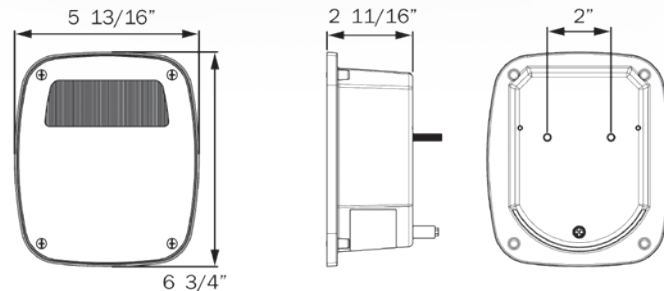

STL60/61 SERIES LED Combination Tail Lights

- Stud mount stop/turn/tail lights with built-in back-up light and reflex
- Choose from Optronics® LED 52-diode and FLEET Count™ 15-diode tail lights
- Hard wired; wire exits through back of housing
- Includes ground wire

BULK P/N	POLYPACK P/N	DESCRIPTION	QTY
OPTRONICS® COMBINATION TAIL LIGHTS - 52 DIODES			
STL60RB	STL60RBP	Passenger side, 16-LED tail, 36-LED back-up	5
STL60RLB	STL60RLBP	Driver side with 5-LED license light	5
FLEET COUNT™ COMBINATION TAIL LIGHTS - 15 DIODES			
STL61RB	STL61RBP	Passenger side, 9-LED tail, 6-LED back-up	5
STL61RLB	STL61RLBP	Driver side with 3-LED license light	5

FMVSS	STL61RB:	S2 T2 I6 A (2)R
	STL61RLB:	S2 T2 I6 A (2)R L
MATERIALS	Acrylic lens, plastic housing	
VOLT/AMP	12.8VDC - Tail .015A, Stop/Turn .308A, Back-up .328A	
WT/DIMS	.882 lb. / 5.813" x 6.75" x 2.688"	
WARRANTY	Lifetime LED Warranty	



STL60RB



STL61RB

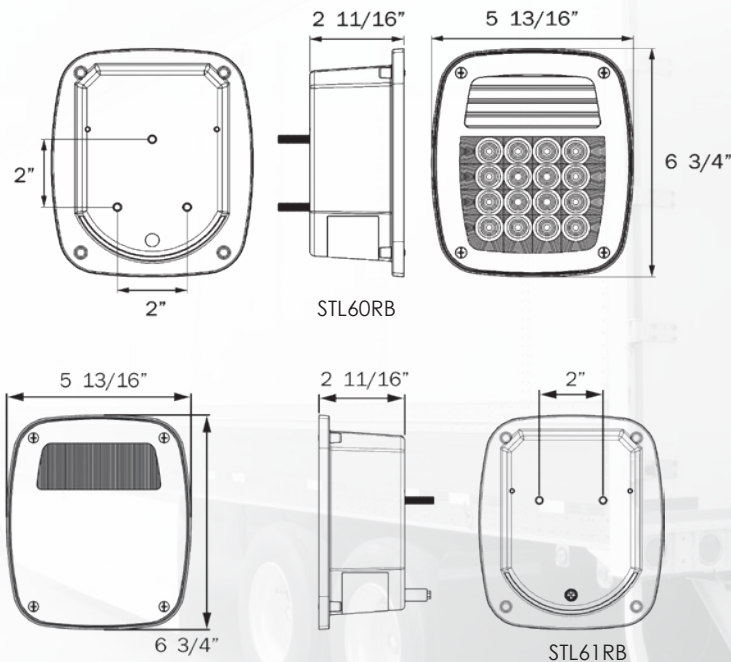



STL82/83 SERIES LED Combination Tail Lights

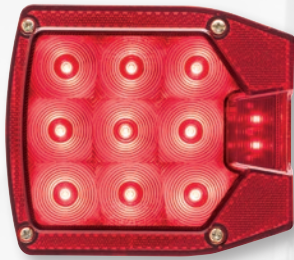

STL82RB



STL83RB

- Low profile style fits standard footprint
- Meets requirements for over and under 80" wide trailers
- SMD LED technology for reliable, waterproof performance
- Stud mount lights mount on 2" centers
- Hard wired, with separate ground wire
- 7-function: stop, turn, tail, rear clearance, rear reflex, side marker and side reflex
- Driver side light also includes license illuminator

BULK P/N	POLYPACK P/N	DESCRIPTION	QTY
COMBINATION TAIL LIGHTS			
STL82RB	STL82RBP	Passenger side, 11 diodes	10
STL83RB	STL83RBP	Driver side, 14 diodes	10

FMVSS	Stop/Tail S2 T2 I6 A, Side Marker A PC, License L
MATERIALS	Acrylic lens and plastic housing
VOLT/AMP	12.8VDC - Stop/Turn .163A, Marker .095A, Tail/License .163A
WT/DIMS	.45 lb. / 5.25" x 4.5" x 1.75"
WARRANTY	Lifetime LED Warranty

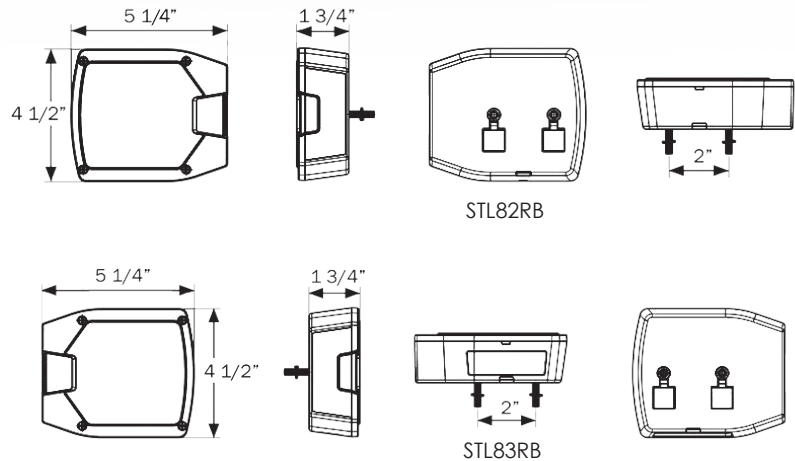

STL108/109 SERIES GloLight® LED Combination Tail Lights

PATENTED TECHNOLOGY

- Traditional style fits many applications
- Stud mount lights mount on 2" centers
- Hard wired, with separate ground wire

BULK P/N	POLYPACK P/N	DESCRIPTION	QTY
COMBINATION TAIL LIGHTS - 25 DIODES			
STL108RB	STL108RBP	Passenger side	10
STL109RB	STL109RBP	Driver side, 3-LED license light	10
RETAIL			
TLL190RK	Set: STL108RB, STL109RB, mounting hardware; Try Me package, clam		2

FMVSS Stop/Tail A I S T, Side Marker A P2, License L

MATERIALS Acrylic lens, ABS housing

VOLT/AMP 12.8VDC - Stop/Turn .310A, Marker .230A

WT/DIMS .970 lb. / 5.031" x 4.563" x 2.625"

WARRANTY Lifetime LED Warranty

GloLight®

LED COMBINATION
TAIL LIGHTS & KITS



TAIL LIGHT



STOP/TURN

STL108/109RB



TLL190RK

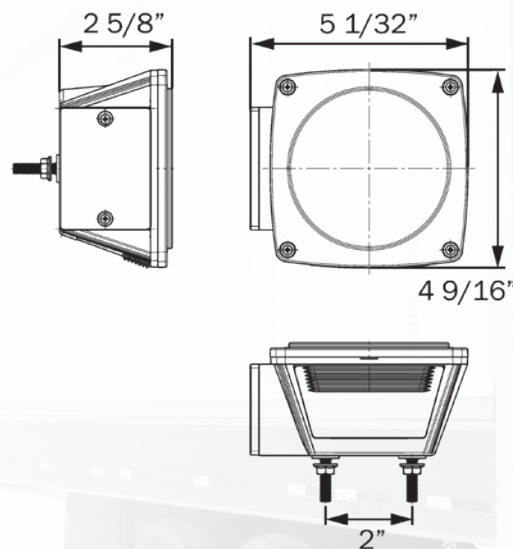



STL38/39 SERIES Waterproof LED Combination Tail Lights

- Traditional style fits many applications
- SMD LED technology for reliable, waterproof performance
- Stud mount lights mount on 2" centers
- Hard wired, with separate ground wire
- Available in bulk, polypack and retail packaging



STL39RB

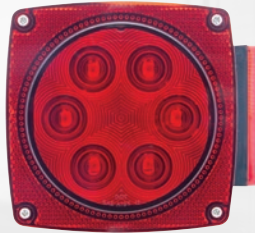

STL38RB



TLL9RK



TLL90RK

BULK P/N	POLYPACK P/N	DESCRIPTION	QTY
COMBINATION TAIL LIGHTS - 7 DIODES			
STL38RB	STL38RBP	Passenger side	10
STL39RB	STL39RBP	Driver side, 3-LED license light	10
RETAIL			
STL6RS	Passenger side, clam		6
STL7RS	Driver side with 3-LED license light, clam		6
TLL9RK	Kit: STL38RB, STL39RB, 25-ft harness, license plate bracket, mounting hardware, clam		2
TLL90RK	Set: STL38RB, STL39RB, mounting hardware, clam		2

FMVSS Stop/Tail A I S T, Side Marker A PC, License L

MATERIALS Acrylic lens and plastic housing

VOLT/AMP 12.8VDC - Stop/Turn .19A, Marker .065A

WT/DIMS .970 lb. / 5" x 4.5" x 2.688"

WARRANTY Lifetime LED Warranty

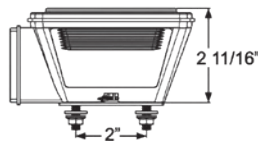
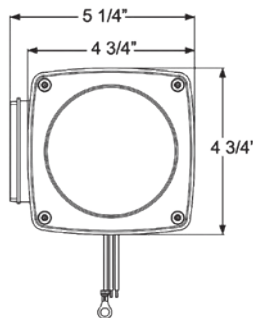

STL8/9 SERIES LED Combination Tail Lights

- Traditional style fits many applications
- Stud mount lights mount on 2" centers
- Hard wired, with separate ground wire

BULK P/N	POLYPACK P/N	DESCRIPTION	QTY
COMBINATION TAIL LIGHTS - 11 DIODES			
STL8RB	STL8RBP	Passenger side	10
STL8R3B	STL8R3BP	Passenger side, female PL-3 plug	10
STL8RGB	STL8RGBP	Passenger side, self-grounding	10
STL9RB	STL9RBP	Driver side, 3-LED license light	10
STL9R3B	STL9R3BP	Driver side, 3-LED license light, female PL-3 plug	10
STL9RGB	STL9RGBP	Driver side, 3-LED license light, self-grounding	10

FMVSS Stop/Tail A I S T, Side Marker A P2, License L

MATERIALS Acrylic lens and plastic housing

VOLT/AMP 12.8VDC - Stop/Turn .259A, Marker .062A

WT/DIMS .970 lb. / 5.25" x 4.75" x 2.688"

WARRANTY Lifetime LED Warranty



STL8/9RB

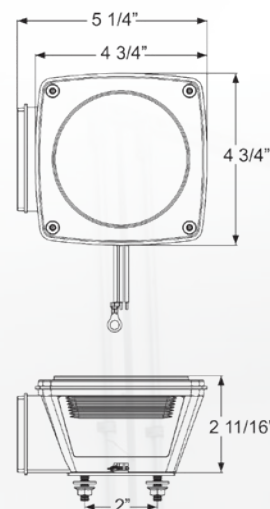



STL2/3 SERIES

LED Combination Tail Lights for Over 80" Applications

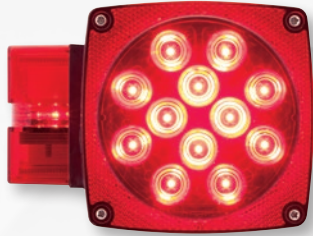

STL3RB



STL2RB

- Designed for over 80" wide applications
- Stud mount lights mount on 2" centers
- Hard wired, with separate ground wire

BULK P/N	POLYPACK P/N	DESCRIPTION	QTY
----------	--------------	-------------	-----

OVER 80 COMBINATION TAIL LIGHTS - 18 DIODES

STL2RB	STL2RBP	Passenger side	10
STL2RGB	STL2RGBP	Passenger side, self-grounding	10
STL3RB	STL3RBP	Driver side, license light	10
STL3RGB	STL3RGBP	Driver side, license light, self-grounding	10

FMVSS	Stop/Tail S2 T2 I6 A, Side Marker PC A, License L
MATERIALS	Acrylic lens and plastic housing
VOLT/AMP	12.8VDC - Stop/Turn .268A, Marker .059A
WT/DIMS	.970 lb. / 6.25" x 4.75" x 2.688"
WARRANTY	Lifetime LED Warranty

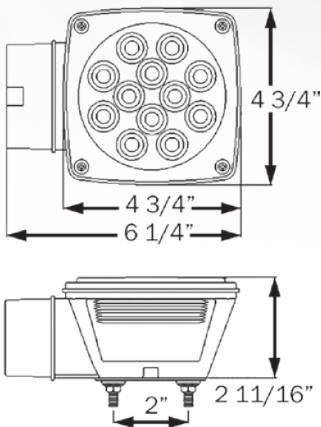

STL008/009 SERIES ONE™ LED Combination Tail Lights

- Sealed, waterproof design
- Traditional style fits many applications
- Stud mount lights mount on 2" centers
- Hard wired with separate ground wire

BULK P/N	POLYPACK P/N	DESCRIPTION	QTY
COMBINATION TAIL LIGHTS - 1 DIODE			
STL008RB	STL008RBP	Passenger side	10
STL009RB	STL009RBP	Driver side	10
STL008RPG	STL008RPGP	Passenger side, .180 bullets	10
STL009RPG	STL009RPGP	Driver side, .180 bullets	10
RETAIL			
STL008RS	Passenger side		6
STL009RS	Driver side with 3-LED license light		6
TLL008RK	Set: STL008RB, STL009RB, mounting hardware, clam		2

FMVSS	S T I A, P2 A, L
MATERIALS	Acrylic lens and plastic housing
VOLT/AMP	12.8VDC - Stop/Turn .25A, Marker .062A
WT/DIMS	.970 lb. / 5.063" x 4.563" x 2.875"
WARRANTY	Lifetime LED Warranty

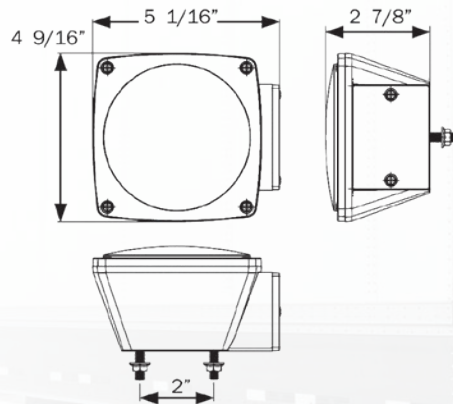

ONE[™]
LED LAMPS



STL008RB



STL009RB



TLL008RK



STL29RB



STL28RB



TLL29RK

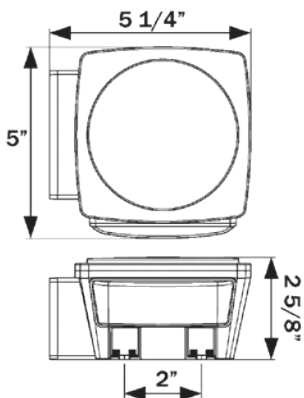

STL28/29 SERIES Miro-Flex™ LED Combination Tail Lights

- Chrome-plated, multi-faceted reflector paired with smooth lens offers unique automotive appearance
- Universal design fits many applications
- SMD LED technology for reliable, waterproof performance
- Stud mount lights mount on 2" centers
- Hard wired with separate ground wire
- STL28 is 6-function: stop, turn, tail, rear reflex, side marker and side reflex
- STL29 is 7-function: above plus license illuminator

BULK P/N	POLYPACK P/N	DESCRIPTION	QTY
COMBINATION TAIL LIGHTS - 15 DIODES			
STL28RB	STL28RBP	Passenger side	10
STL29RB	STL29RBP	Driver side, with 5-LED license light	10
RETAIL			
TLL28RK	Set: STL28RB, STL29RB, mounting hardware; clam		2
TLL29RK	Kit: STL28RB, STL29RB, 25-ft harness, license plate bracket, mounting hardware; clam		2

FMVSS	STL28:	Stop/Tail A I S T, Side Marker A P2
	STL29:	Stop/Tail A I S T, Side Marker A P2, License L
MATERIALS	Acrylic lens and plastic housing	
VOLT/AMP	STL28:	12.8VDC - .174A Stop/Turn, .054A Marker
	STL29:	12.8VDC - .174A Stop/Turn, .054A Marker
WT/DIMS	.750 lb. / 5.25" x 5" x 2.625"	
WARRANTY	Lifetime LED Warranty	

STL116/117 SERIES GloLight® LED Low Profile Combination Tail Lights

PATENTED
TECHNOLOGY

- PATENTED TECHNOLOGY
- Designed for marine trailer application
- Sealed, waterproof construction
- Universal mount
- Hard wired, with separate ground wire

BULK P/N	POLYPACK P/N	DESCRIPTION	QTY
COMBINATION TAIL LIGHTS - 28 DIODES			
STL116RB	STL116RBP	Passenger side	10
STL117RB	STL117RBP	Driver side, with 6-LED license light	10
RETAIL			
TLL170RK	Set: STL116RB, STL117RB, mounting hardware, Try Me package		2

FMVSS	STL116: A I S T, P2 A ; STL117: A I S T, P2 A, L
MATERIALS	Acrylic lens and plastic housing
VOLT/AMP	12.8VDC - Stop/Turn .252A, Marker .135A
WT/DIMS	.816 lb. / 8" x 2.9" x 2.6"
WARRANTY	Lifetime LED Warranty

GloLight®



TAIL LIGHT

STL116RB



STOP/TURN

STL117RB



TLL170RK
Try Me Kit

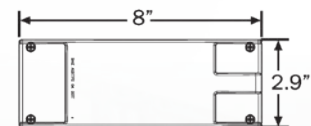

LED COMBINATION
TAIL LIGHTS & KITS



STL616/617 SERIES LightGuide™ LED Combination Stop/Turn/Tail Light

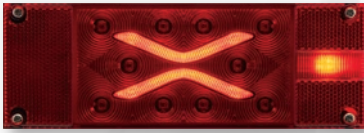

TAIL LIGHT STL616NTRB



STOP/TURN STL617NTRB

PATENTED TECHNOLOGY

- Central X-shaped feature illuminates for tail light function
- Surrounding diodes light for stop and turn functions
- Designed for marine trailer application
- Sealed, waterproof construction
- Universal mount
- Hard wired, with separate ground wire

BULK P/N	POLYPACK P/N	DESCRIPTION	QTY
COMBINATION TAIL LIGHTS - 16 DIODES			
STL616NTRB	STL616NTRBP	Passenger side	10
STL617NTRB	STL617NTRBP	Driver side, with 3-LED license light	10

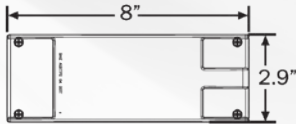

FMVSS	S T I A P2, P2 A, L
MATERIALS	Acrylic lens and plastic housing
VOLT/AMP	12.8VDC - Stop .259/Tail .062
WT/DIMS	.816 lb. / 8.063" x 2.875" x 2.813"
WARRANTY	Lifetime LED Warranty

STL16/17 SERIES LED Combination Tail Lights

- Designed for marine trailer application
- Sealed, waterproof construction
- Universal mount
- Hard wired, with separate ground wire
- STL16/17NTRB feature light tube technology and SMD LED

BULK P/N	POLYPACK P/N	DESCRIPTION	QTY
COMBINATION TAIL LIGHTS - 18 DIODES			
STL16RB	STL16RBP	Passenger side	10
STL17RB	STL17RBP	Driver side, with 4-LED license light	10
STL16NTRB	STL16NTRB	Passenger side, SMD LED	10
STL17NTRB	STL17NTRB	Driver side, SMD LED with 4-LED license light	10
ACCESSORIES			
AL16RB	AL16RBP	Tail light lens for STL16/17RB	50
AL17RB	AL17RBP	Side marker lens STL16/17RB	50
RETAIL			
STL16RS	Passenger side, stainless hardware		6
STL17RS	Driver side with 4-LED license light, stainless hardware		6
TLL160RK	Set: STL16RB, STL17RB, mounting hardware; clam		2
TLL16RK	Kit: STL16RB, STL17RB, 25-ft harness, license plate bracket, stainless steel mounting hardware; clam		2

FMVSS	STL16: Stop/Tail A I S T P2 PC, Side Marker A P2 STL17: Stop/Tail A I S T P2 PC, Side Marker A P2, License L
MATERIALS	Acrylic lens and plastic housing
VOLT/AMP	STL16: 12.8VDC - .259A Stop/Turn, .062A Marker STL17: 12.8VDC - .268A Stop/Turn, .059A Marker
WT/DIMS	.816 lb. / 8.063" x 2.875" x 2.813"
WARRANTY	Lifetime LED Warranty

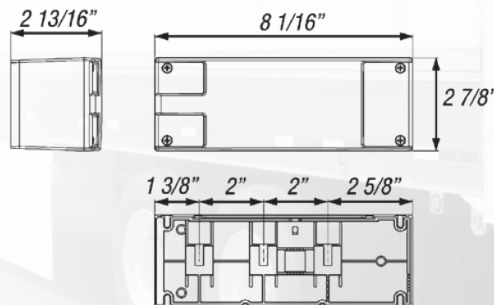

STL17RB



STL16NTRB



TLL16RK





STL15RB

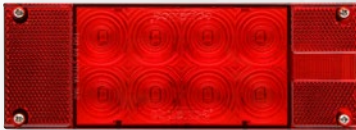

STL14RB

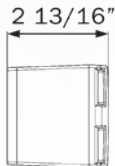
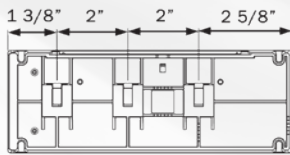
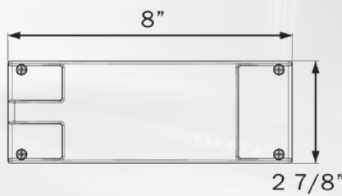

STL14/15 SERIES FLEET Count™ LED Low Profile Combination Tail Lights

- Designed for marine trailer application
- Sealed, waterproof construction
- Universal mount
- Hard wired, with separate ground wire

BULK P/N	POLYPACK P/N	DESCRIPTION	QTY
COMBINATION TAIL LIGHTS - 12 DIODES			
STL14RB	STL14RBP	Passenger side	10
STL14R1B	STL14R1BP	Passenger side, 16-in. leads	10
STL15RB	STL15RBP	Driver side, with 6-LED license light	10
STL15R1B	STL15R1BP	Driver side, with 6-LED license light, 16-in. leads	10

FMVSS	STL14: A I S T, P2 A; STL15: A I S T, P2 A, L
MATERIALS	Acrylic lens and plastic housing
VOLT/AMP	12.8VDC - Stop/Turn .252A. Marker .135A
WT/DIMS	.816 lb. / 8" x 2.875" x 2.813"
WARRANTY	Lifetime LED Warranty

STL0016/0017 SERIES ONE™ LED Combination Tail Lights

- Designed for marine trailer application
- Sealed, waterproof construction
- Universal mount
- Hard wired, with separate ground wire



LED COMBINATION
TAIL LIGHTS & KITS



STL0016RB



STL0017RB



TLL0016RK

BULK P/N	POLYPACK P/N	DESCRIPTION	QTY
COMBINATION TAIL LIGHTS			
STL0016RB	STL0016RBP	Passenger side	10
STL0017RB	STL0017RBP	Driver side, with license light	10
STL0016RP2G	STL0016RP2GP	Passenger side, 2-pin male/female plug, ring terminal on ground	10
STL0017RP2G	STL0017RP2GP	Driver side, with license light, 2-pin male/female plug, ring terminal on ground	10
RETAIL			
STL0016RS	Passenger side, clam		6
STL0017RS	Driver side with 4-LED license light, clam		6
TLL0016RK	Set: STL0016RB, STL0017RB, mounting hardware, clam		2

FMVSS STL0016: Stop/Tail A I S T P2, Side Marker A P2
STL0017: Stop/Tail A I S T P2, Side Marker A P2, License L

MATERIALS Acrylic lens and plastic housing

VOLT/AMP STL0016: 12.8VDC - .31A Stop/Turn, .12A Marker
STL0017: 12.8VDC - .32A Stop/Turn, .26A Marker

WT/DIMS .816 lb. / 8.0" x 2.9" x 2.6"

WARRANTY Lifetime LED Warranty

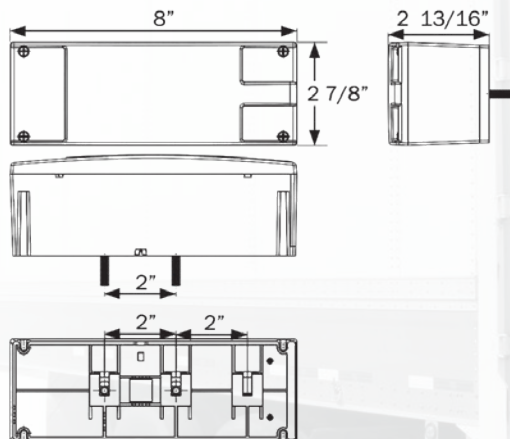



STL26/27 SERIES Miro-Flex™ LED Combination Tail Lights

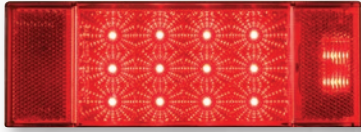

STL26RB

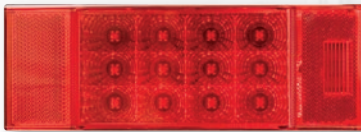

STL27RB



TLL26RK

- Designed for marine trailer application
- Sealed, waterproof construction
- Universal mount
- Hard wired, with separate ground wire

BULK P/N	POLYPACK P/N	DESCRIPTION	QTY
COMBINATION TAIL LIGHTS - 14 DIODES			
STL26RB	STL26RBP	Passenger side	10
STL27RB	STL27RBP	Driver side with 4-LED license light	10
RETAIL			
TLL26RK	Set: STL26RB, STL27RB, mounting hardware; clam		2



FMVSS	STL26: S2 T2 I6 A PC
	STL27: S2 T2 I6 A PC L
MATERIALS	Acrylic lens and plastic housing
VOLT/AMP	STL26: 12.8VDC - .167A Stop/Turn, .054A Marker
	STL27: 12.8VDC - .167A Stop/Turn, .107A Marker/License
WT/DIMS	.882 lb. / 8.063" x 2.938" x 2.688"
WARRANTY	Lifetime LED Warranty

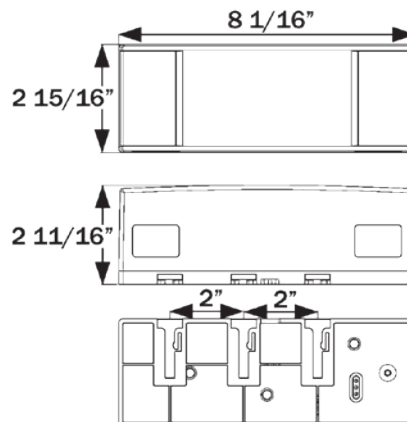

STL36/37 SERIES LED Combination Tail Lights

- Designed for marine trailer application
- Sealed, waterproof construction
- Universal mount
- Hard wired, with separate ground wire

BULK P/N	POLYPACK P/N	DESCRIPTION	QTY
COMBINATION TAIL LIGHTS - 17 DIODES			
STL36RB	STL36RBP	Passenger side	20
STL36RPG	STL36RPGP	Passenger side, dual plug and ground eyelet	20
STL37RB	STL37RBP	Driver side, 6-LED license light	20
STL37RPG	STL37RPGP	Driver side, 6-LED license light, dual plug and ground eyelet	20
RETAIL			
STL36RS	Passenger side		6
STL37RS	Driver side with 4-LED license light		6
TLL36RK	Kit: STL36RB, STL37RB, (2) MCL91AK sealed yellow marker lights with chrome bases, 25-ft harness, license plate bracket, stainless steel mounting hardware; clam		2

FMVSS	STL36: Stop/Tail A S T I P2, Side Marker A PC STL37: Stop/Tail A S T I P2, Side Marker A PC, License L
MATERIALS	Acrylic lens and plastic housing
VOLT/AMP	12.8VDC - .181A Stop/Turn, .047A Marker
WT/DIMS	.992 lb. / 7.875" x 3.25" x 2.875"
WARRANTY	Lifetime LED Warranty

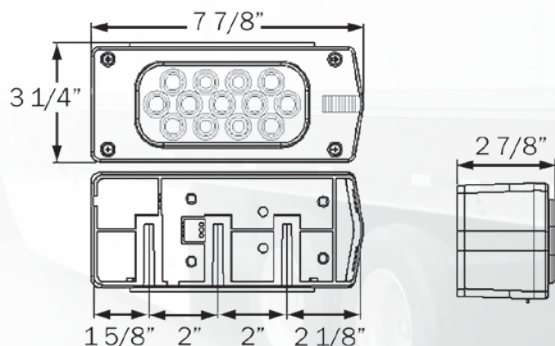

STL36/37RB



TLL36RK





STL56/57 SERIES LED Combination Tail Lights

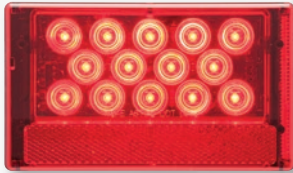

STL56/57RB

- Designed for marine trailer application
- Sealed, waterproof construction
- Universal mount
- Hard wired, with separate ground wire
- Stainless steel hardware

BULK P/N	POLYPACK P/N	DESCRIPTION	QTY
COMBINATION TAIL LIGHTS - 18 DIODES			
STL56RB	STL56RBP	Passenger side	10
STL57RB	STL57RBP	Driver side, 5-LED license light	10
RETAIL			
TLL56RK	Kit: STL56RB, STL57RB, 25-ft harness, license plate bracket, stainless steel mounting hardware; clam		2



TLL56RK

FMVSS	STL56: Stop/Tail A S T I P2, Side Marker A P2
	STL57: Stop/Tail A S T I P2, Side Marker A P2, License L
MATERIALS	Acrylic lens and plastic housing
VOLT/AMP	STL56: 12.8VDC - .259A Stop/Turn, .062A Marker
	STL57: 12.8VDC - .268A Stop/Turn, .059A Marker
WT/DIMS	.816 lb. / 6.063" x 3.625" x 2.25"
WARRANTY	Lifetime LED Warranty

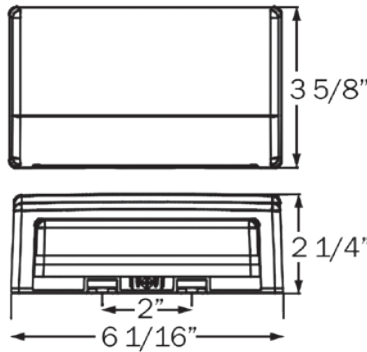

TLL21RK LED Wireless Towing Light Kit

- Sonically sealed, waterproof stop/turn/tail lights
- Magnetic base mounts securely on metal surfaces
- Wire harness connects to towing vehicle



TLL21RK

BULK P/N	POLYPACK P/N	DESCRIPTION	QTY
RETAIL			
TLL21RK		Towing light kit with wiring harness, clam 	2

FMVSS	ST I
MATERIALS	Polycarbonate
VOLT/AMP	12.8VDC - .360A Stop/Turn, .030A Tail
WT/DIMS	2 lbs. / 3.938" x 5.875" x 2.186"
WARRANTY	Lifetime LED Warranty

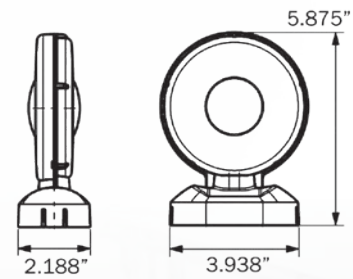

LED COMBINATION
TAIL LIGHTS & KITS



TLL31RK LED Wireless Towing Light Kit



TLL31RK

- Battery powered stop/turn/tail lights
- Sonically sealed, waterproof
- Magnetic base mounts securely on metal surfaces
- Wireless design simplifies installation, includes wireless transmitter



BULK P/N	POLYPACK P/N	DESCRIPTION	QTY
RETAIL			
TLL31RK		LED wireless magnet mount towing light kit, clam	2



FMVSS	S T I
MATERIALS	Polycarbonate
VOLT/AMP	12.8VDC - .360A Stop/Turn, .030A Tail
WT/DIMS	2 lbs. / 3.938" x 6" x 2.188"
WARRANTY	Lifetime LED Warranty

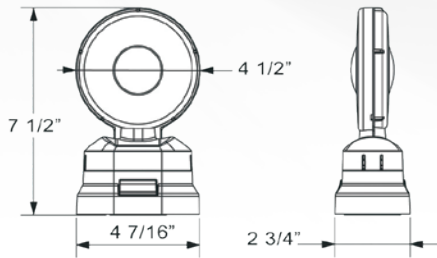

BUL603 SERIES

LightGuide™ 4" Round Sealed Back-Up Lights

PATENTED TECHNOLOGY

- Sonically sealed, waterproof
- Grommet mount
- Accepts industry standard PL-3 connector
- Central X-shaped feature illuminates for auxiliary tail light function (BUL603CRB only)

BULK P/N	POLYPACK P/N	DESCRIPTION	QTY
CLEAR BACK-UP LIGHTS - 12 DIODES			
BUL603CB	BUL603CBP	Clear lens, grommet mount, 2-pin connection	10
BUL603CRB	BUL603CRBP	Clear lens, grommet mount, red auxiliary tail function, PL-3 connection	10
ACCESSORIES			
A45GB	A45GBP	Grommet	50
A45CB	A45CBP	Pigtail, 2-wire	100
A49PB	A49PBP	Right angle pigtail, 2-wire	100
A45PB	A45PBP	Pigtail, 3-wire	100
A47PB	A47PBP	Right angle pigtail, 3-wire	100

FMVSS	(2) R
MATERIALS	Polycarbonate lens and housing
VOLT/AMP	12.8VDC - 0.216A
WT/DIMS	.28 lbs. / 4.3" x 4.3" x 1.08"
WARRANTY	Lifetime LED Warranty



BUL603CB

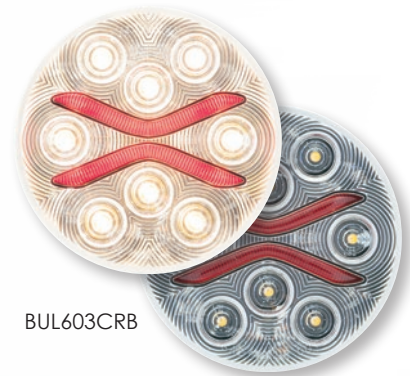

BUL603CRB

LED DOT COMPLIANT
BACK-UP LIGHTS

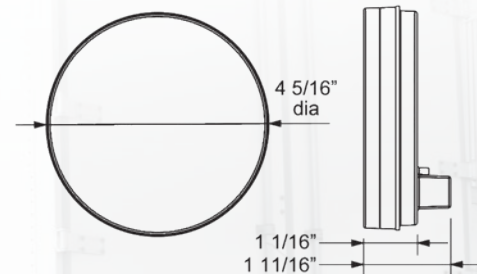



BUL101 SERIES GloLight® 4" Round Sealed DOT LED Back-Up Lights

PATENTED TECHNOLOGY

- Sonically sealed, waterproof
- Certified for back-up light function when installed as pair in two-lamp system [SAE (2)R]



BUL101CB

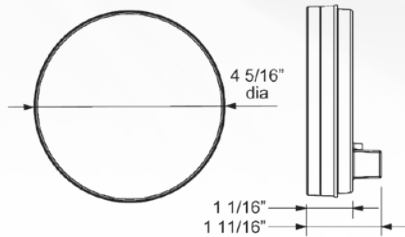

HOLE CUT-OUT: 4.5"

BULK P/N	POLYPACK P/N	DESCRIPTION	QTY
CLEAR BACK-UP LIGHTS - 21 DIODES			
BUL101CB	BUL101CBP	Standard 2-pin connection	10
BUL101CKB	BUL101CKBP	Kit with A45GB and A49PB	10
ACCESSORIES			
A45GB	A45GBP	Grommet	50
A45CB	A45CBP	Pigtail, 2-wire	100
A49PB	A49PBP	Right angle pigtail, 2-wire	100
BK45BB	BK45BBP	Black steel bracket	10
A45BB	A45BBP	Black plastic flange	100
A45SB	A45SBP	Stainless steel mounting flange	20
A45CGB	A45CGBP	Chrome grommet cover	20

FMVSS	(2) R
MATERIALS	Polycarbonate lens and housing
VOLT/AMP	12.8VDC - 0.425A
WT/DIMS	.309 lbs. / 4.313" x 4.313" x 1.625"
WARRANTY	Lifetime LED Warranty

BUL11 SERIES 4" Round Sealed Clear DOT LED Back-Up Lights

- Sonically sealed, waterproof
- Certified for back-up light function when installed as pair in two-lamp system [SAE (2)R]
- Available in grommet and flange mount models
- Grommet mount version available with standard 2-pin, or optional weathertight connection
- Grommet mount version available in 12V and 24V



BUL11CB



BUL11CBX



BULK P/N	POLYPACK P/N	DESCRIPTION	QTY
CLEAR BACK-UP LIGHTS - 10 DIODES			
BUL11CB	BUL11CBP	12V, two-pin connection	10
BUL11CKB	BUL11CKBP	12V kit: BUL11CB, A45GB & A49PB	10
BUL11CMB	BUL11CMBP	12V, weathertight connection	10
BUL11CM24B	BUL11CM24BP	24V, weathertight connection	10
CLEAR BACK-UP LIGHT WITH REFLEX - 10 DIODES			
BUL11CBX	BUL11CBXP	12V, two-pin connection	10
ACCESSORIES			
A45GB	A45GBP	Grommet	50
A45CB	A45CBP	Pigtail, 2-wire	100
A49PB	A49PBP	Right angle pigtail, 2-wire	100
A45PMB	A45PMBP	Weathertight pigtail	100
AL45PWTB	AL45PWTBP	Weathertight to PL-3 adaptor	50
FMVSS	(2) R		
MATERIALS	Polycarbonate lens and housing		
VOLT/AMP	12.8VDC - 0.26A		
WT/DIMS	BUL11CB/CKB:	.309 lbs. / 4.313" x 4.313" x 1.625"	
	BUL11CMB/CM24B:	.309 lbs. / 4.313" x 4.313" x 1.625"	
	BUL11CBX:	.353 lbs. / 5.75" x 5.75" x 1.625"	
WARRANTY	Lifetime LED Warranty		

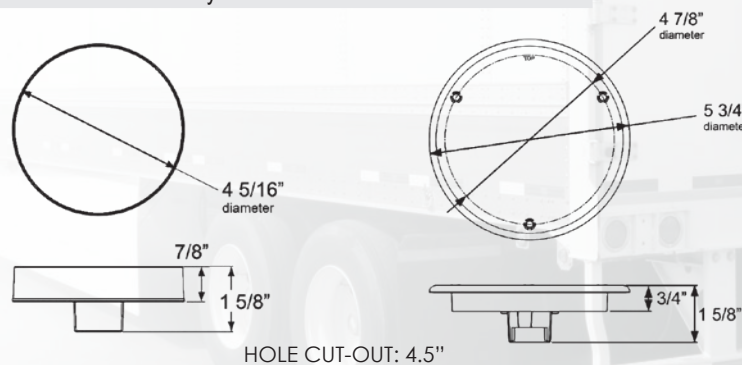

LED DOT COMPLIANT
BACK-UP LIGHTS



BUL06 SERIES

FLEET Count™ 4" Round Sealed DOT LED Back-Up Lights

- Sonically sealed, waterproof
- Certified for back-up light function when installed as pair in two-lamp system [SAE (2)R]



BUL06CB



BUL06CFB

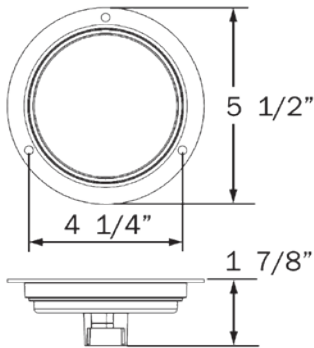

BUL06CFB

HOLE CUT-OUT: 4.579"

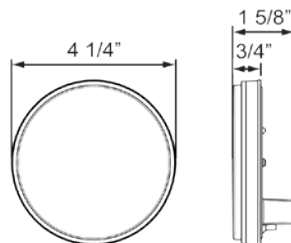

BUL06CB

HOLE CUT-OUT: 4.528"

BULK P/N	POLYPACK P/N	DESCRIPTION	QTY
CLEAR BACK-UP LIGHTS - 6 DIODES			
BUL06CB	BUL06CBP	Grommet mount, 2-pin connection	10
BUL06C1224B	BUL06C1224BP	Grommet mount, 2-pin connection, 12/24V	10
BUL06CKB	BUL06CKBP	Kit with A45GB and A49PB, 2-pin	10
BUL06CMB	BUL06CMBP	Grommet mount, weathertight connection	10
BUL06CK1MB	BUL06CK1MBP	Kit: BUL06CMB with A45GB grommet, weathertight connection	10
BUL06CFB	BUL06CFBP	Flange mount, 2-pin connection	10
BUL06CFMB	BUL06CFMBP	Flange mount, weathertight connection	10
ACCESSORIES			
A45GB	A45GBP	Grommet	50
A45CB	A45CBP	Pigtail, 2-wire	100
A49PB	A49PBP	Right angle pigtail, 2-wire	100
BK45BB	BK45BBP	Black steel bracket	10
A45BB	A45BBP	Black plastic flange	100
A45SB	A45SBP	Stainless steel mounting flange	20
A45CGB	A45CGBP	Chrome grommet cover	20
A45PMB	A45PMBP	Weathertight pigtail	100

FMVSS	(2) R
MATERIALS	Polycarbonate lens and housing
VOLT/AMP	12.8VDC - 0.180A
WT/DIMS	Grommet mount: .309 lbs. / 4.25" x 4.25" x 1.625" Flange mount: .350 lbs. / 5.5" x 5.5" x 1.875"
WARRANTY	Lifetime LED Warranty

BUL003 SERIES ONE™ LED 4" Round Sealed DOT Back-Up Lights



LED DOT COMPLIANT
BACK-UP LIGHTS

- Sonically sealed, waterproof
- Certified for back-up light function when installed as pair in two-lamp system [SAE (2)R]

BULK P/N	POLYPACK P/N	DESCRIPTION	QTY
CLEAR BACK-UP LIGHTS - 1 DIODE			
BUL003CB	BUL003CBP	Grommet mount, 2-pin connection	10
BUL003CKB	BUL003CKBP	Kit with A45GB grommet and A45CB pigtail	10
BUL003C1224B	BUL003C1224BP	Grommet mount, 2-pin connection 12-24V	50
ACCESSORIES			
A45GB	A45GBP	Grommet	50
A45CB	A45CBP	Pigtail, 2-wire	100
A49PB	A49PBP	Right angle pigtail, 2-wire	100



BUL003CB

FMVSS	(2) R
MATERIALS	Polycarbonate lens and housing
VOLT/AMP	12.8VDC - .26A
WT/DIMS	.22 lbs. / 4.313" x 4.313" x 1.688"
WARRANTY	Lifetime LED Warranty

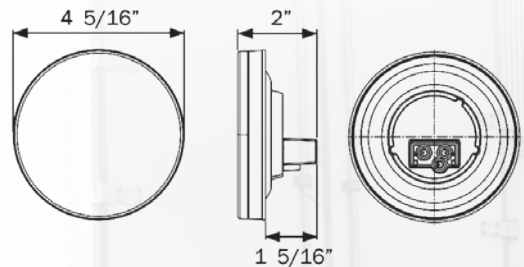



BUL23/53 SERIES 4" Round Sealed Clear DOT LED Back-Up Lights



BUL23CB



BUL53CB

- Sonically sealed, waterproof
- Certified for back-up light function when installed as pair in two-lamp system [SAE (2)R]
- High diode count; choose from 27- or 36-LED models
- 27-LED version available in 12V and 12-24V

BULK P/N	POLYPACK P/N	DESCRIPTION	QTY
CLEAR BACK-UP LIGHTS - 27 DIODES			
BUL23CB	BUL23CBP	12V, 2-pin connection	10
BUL23C24B	BUL23C24BP	12-24V, 2-pin connection	10
CLEAR BACK-UP LIGHT - 36 DIODES			
BUL53CB	BUL53CBP	12V, two-pin connection	10
ACCESSORIES			
A45GB	A45GBP	Grommet	50
A45CB	A45CBP	Pigtail, 2-wire	100
A49PB	A49PBP	Right angle pigtail, 2-wire	100

FMVSS	(2) R
MATERIALS	Polycarbonate lens and housing
VOLT/AMP	BUL23: 12.8VDC - 0.145A BUL53: 12.8VDC - 0.275A
WT/DIMS	.309 lbs. / 4.313" x 4.313" x 2"
WARRANTY	Lifetime LED Warranty

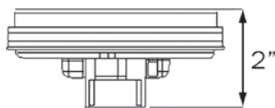
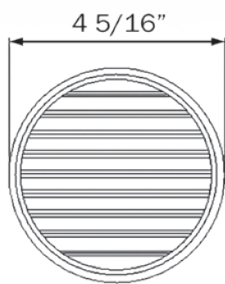

HOLE CUT-OUT: 4.5"

BUL602 SERIES

LightGuide™ 6" Oval Sealed DOT Back-Up Lights

PATENTED TECHNOLOGY (pat. D820,486)

- Sonically sealed, waterproof
- Grommet mount
- Certified for back-up light function when installed as pair in two-lamp system [SAE (2)R]
- BUL602CRB includes auxiliary tail light function

BULK P/N	POLYPACK P/N	DESCRIPTION	QTY
CLEAR BACK-UP LIGHTS - 12 DIODES			
BUL602CB	BUL602CBP	Grommet mount, 2-pin connection	10
BUL602CRB	BUL602CRBP	Grommet mount, supplemental tail light function, PL-3 connection	10
ACCESSORIES			
A70GB	A70GBP	Grommet	50
A45PB	A45PBP	Pigtail, 3-wire	100
A47PB	A47PBP	Right angle pigtail, 3-wire	100
A45CB	A45CBP	Pigtail, 2-wire	100
A49PB	A49PBP	Right angle pigtail, 2-wire	100

FMVSS	(2) R
MATERIALS	Polycarbonate lens and housing
VOLT/AMP	12.8VDC - 0.381A
WT/DIMS	.375 lbs. / 6.5" x 2.8" x 1.80"
WARRANTY	Lifetime LED Warranty



BUL602CB

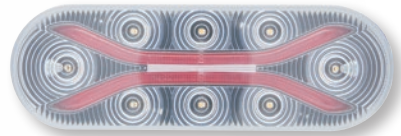

BUL602CRB

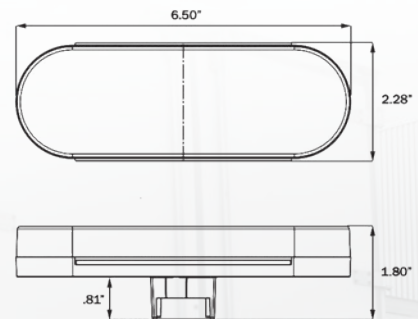

HOLE CUT-OUT: 6.85" x 2.52" (1.26" R)

LED DOT COMPLIANT
BACK-UP LIGHTS

GloLight[®]



BUL111CB

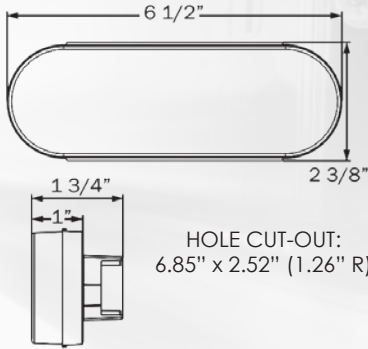

BUL111 SERIES

GloLight[®] 6" Oval Sealed DOT LED Back-Up Lights

PATENTED TECHNOLOGY

- Sonically sealed, waterproof
- Certified for back-up light function when installed as pair in two-lamp system [SAE (2)R]

BULK P/N	POLYPACK P/N	DESCRIPTION	QTY
----------	--------------	-------------	-----

CLEAR BACK-UP LIGHTS - 22 DIODES

BUL111CB	BUL111CBP	Standard two-pin connection	10
----------	-----------	-----------------------------	----

ACCESSORIES

A70GB	A70GBP	Grommet	50
A45CB	A45CBP	Pigtail, 2-wire	100
A49PB	A49PBP	Right angle pigtail, 2-wire	100

FMVSS	(2) R
MATERIALS	Polycarbonate lens and housing
VOLT/AMP	12.8VDC - 0.386A
WT/DIMS	.265 lbs. / 6.5" x 2.375" x 1.75"
WARRANTY	Lifetime LED Warranty

BUL10/22/52 SERIES 6" Oval Sealed Clear DOT LED Back-Up Lights

- Sonically sealed, waterproof
- Certified for back-up light function when installed as pair in two-lamp system [SAE (2)R]
- Low to high diode count; choose from 10-, 27- or 36-LED models
- Accept standard two-pin plugs

BULK P/N	POLYPACK P/N	DESCRIPTION	QTY
CLEAR BACK-UP LIGHT - 10 DIODES			
BUL10CB	BUL10CBP	Standard two-pin connection	10
CLEAR BACK-UP LIGHT - 27 DIODES			
BUL22CB	BUL22CBP	Standard two-pin connection	10
CLEAR BACK-UP LIGHT - 36 DIODES			
BUL52CB	BUL52CBP	Standard two-pin connection	10
ACCESSORIES			
A70GB	A70GBP	Grommet	50
A45CB	A45CBP	Pigtail, 2-wire	100
A49PB	A49PBP	Right angle pigtail, 2-wire	100

FMVSS	(2) R	
MATERIALS	Polycarbonate lens and housing	
VOLT/AMP	BUL10:	12.8VDC - 0.260A
	BUL22:	12.8VDC - 0.125A
	BUL52:	12.8VDC - 0.275A
WT/DIMS	BUL10:	.265 lbs. / 6.438" x 2.25" x 1.75"
	BUL22/52:	.397 lbs. / 6.5" x 2.313" x 1.813"
WARRANTY	Lifetime LED Warranty	



BUL10CB

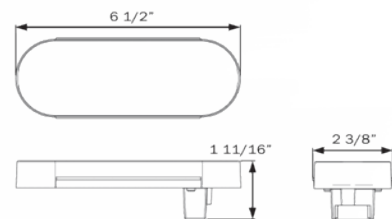

HOLE CUT-OUT: 6.85" x 2.5" (1.25" R)



BUL22CB



BUL52CB

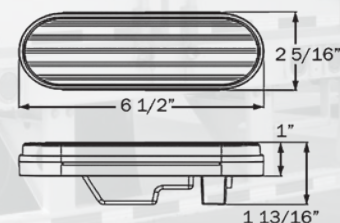

HOLE CUT-OUT: 6.85" x 2.5" (1.25" R)

LED DOT COMPLIANT
BACK-UP LIGHTS



BUL12 SERIES FLEET Count™ 6" Oval Sealed DOT LED Back-Up Lights



BUL12CB



BUL12CFB

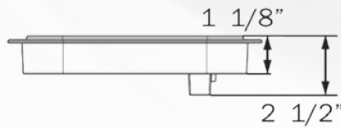
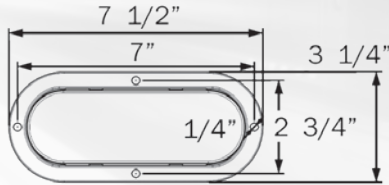

BUL12CFB

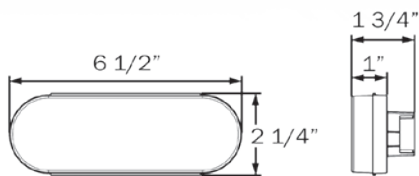

BUL12CB

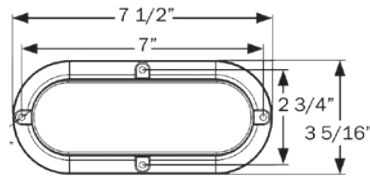

BUL12CSB

- Sonically sealed, waterproof
- Available with standard or weathertight connection
- Flange mount models available for recess or surface mount installation
- Certified for back-up light function when installed as pair in two-lamp system [SAE (2)R]

BULK P/N	POLYPACK P/N	DESCRIPTION	QTY
----------	--------------	-------------	-----

CLEAR BACK-UP LIGHTS - 6 DIODES

BUL12CB	BUL12CBP	Recess mount, 2-pin	10
BUL12C1224B	BUL12C1224BP	Recess mount, 2-pin, 12/24V	10
BUL12CKB	BUL12CKBP	Kit with A70GB and A45CB, 2-pin	10
BUL12CFB	BUL12CFBP	Recess flange mount, 2-pin	10
BUL12CB1FPG	BUL12CB1FPGP	Kit: Hard wired recess mount light with black mounting flange, female PL-3 plug	10
BUL12CSB	BUL12CSBP	Surface flange mount, hard wired	10

ACCESSORIES

A70GB	A70GBP	Grommet	50
A45CB	A45CBP	Pigtail, 2-wire	100
A49PB	A49PBP	Right angle pigtail, 2-wire	100
A45PMB	A45PMBP	Pigtail, weathertight	50
AL45PWTB	AL45PWTBP	Weathertight to PL-3 adaptor	50
A111TRSSB	A111TRSSBP	Stainless steel trim ring	50

FMVSS (2) R

MATERIALS Polycarbonate lens and housing

VOLT/AMP 12.8VDC - 0.260A

WT/DIMS .265 lbs. / 6.5" x 2.25" x 1.75"

WARRANTY Lifetime LED Warranty

BUL002 SERIES ONE™ LED 6" Oval Sealed DOT Back-Up Lights

- Sonically sealed, waterproof
- Certified for back-up light function when installed as pair in two-lamp system [SAE (2)R]

ONE™
LED LAMPS



BUL002CB

LED DOT COMPLIANT
BACK-UP LIGHTS

BULK P/N	POLYPACK P/N	DESCRIPTION	QTY
CLEAR BACK-UP LIGHTS - 1 DIODE			
BUL002CB	BUL002CBP	Standard two-pin connection	10
BUL002CM3B	BUL002CM3BP	Weathertight connection, three-pin	10
ACCESSORIES			
A70GB	A70GBP	Grommet	50
A45CB	A45CBP	Pigtail, 2-wire	100
A49PB	A49PBP	Right angle pigtail, 2-wire	100
A45PMB	A45PMBP	Pigtail, weathertight	50
AL45PWTB	AL45PWTBP	Weathertight to PL-3 adaptor	50

FMVSS	(2) R
MATERIALS	Polycarbonate lens and housing
VOLT/AMP	12.8VDC - 0.30A
WT/DIMS	.265 lbs. / 6.5" x 2.375" x 1.75"
WARRANTY	Lifetime LED Warranty

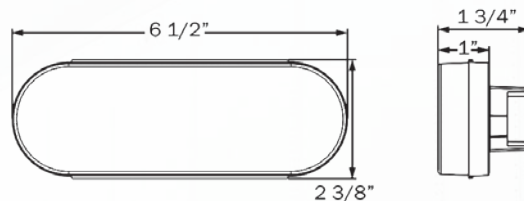

HOLE CUT-OUT: 6.85" x 2.52" (1.26" R)



BUL35/90 SERIES Sealed Clear DOT LED Back-Up Lights



BUL35CB

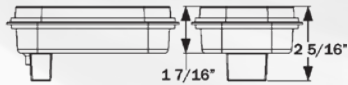
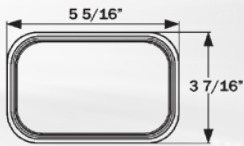

HOLE CUT-OUT: 5.462" x 3.562" (1" R)

- Sonically sealed, waterproof
- Certified for back-up light function when installed as pair in two-lamp system [SAE (2)R]
- BUL35 and BUL24 are 5.5" x 3.5" recess mount models that accept standard two-pin plugs
- BUL90 is 7" surface mount model, hard wired, with separate ground wire; designed for transit vehicles

BULK P/N	POLYPACK P/N	DESCRIPTION	QTY
----------	--------------	-------------	-----

CLEAR 5.5" x 3.5" BACK-UP LIGHTS - 16 DIODES

BUL35CB	BUL35CBP	Standard two-pin connection, 12V	10
BUL24CB	BUL24CBP	Standard two-pin connection, 12-24V	10

CLEAR 7" BACK-UP LIGHTS - 42 DIODES

BUL90CB	BUL90CBP	12V, hard wired	5
BUL90C24B	BUL90C24BP	24V, hard wired	5

ACCESSORIES

A33GB	A33GBP	Grommet for BUL35CB	50
A45CB	A45CBP	Pigtail, 2-wire	100
A49PB	A49PBP	Right angle pigtail, 2-wire	100



BUL90CB

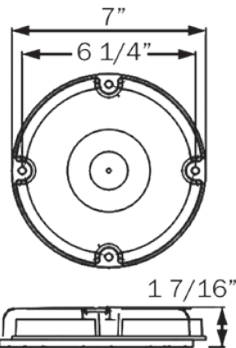

FMVSS	(2) R
MATERIALS	Polycarbonate lens and housing
VOLT/AMP	BUL35: 12.8VDC - 0.295A BUL24: 24.VDC - 0.198A BUL90: 12.8VDC - 0.301A BUL90: 24.0VDC - 0.089A
WT/DIMS	BUL35/24: .397 lbs. / 5.313" x 3.438" x 2.313" BUL90: .970 lbs. / 7" x 7" x 1.438"
WARRANTY	Lifetime LED Warranty

SLL43 SERIES 4" Round Sealed LED Warning Lamps

- Sonically sealed, waterproof
- Flashing lights with double-flash function, meeting SAE J595 and J845 standards for Class 2 and Class 3 directional warning lamps
- Use two Function 1 or Function 2 lights for synchronous flashing or pair a Function 1 with a Function 2 light for alternating flash pattern
- Accepts standard PL-3 plugs
- Operating voltage 9-30VDC, suitable for 12V or 24V systems

BULK P/N	POLYPACK P/N	DESCRIPTION	QTY
YELLOW WARNING LIGHTS - 22 DIODES			
SLL43AB1	SLL43AB1P	12V-24V Function 1	10
SLL43AB2	SLL43AB2P	12V-24V Function 2	10
SLL43AKB1	SLL43AKB1P	12V-24V Function 1, kit with A45GB & A45PB	10
SLL43AKB2	SLL43AKB2P	12V-24V Function 2, kit with A45GB & A45PB	10
ACCESSORIES			
A45GB	A45GBP	Grommet, 4" round	50
A45PB	A45PBP	Pigtail, 3-wire	100
A47PB	A47PBP	Right angle pigtail, 3-wire	100

FMVSS	W-2
MATERIALS	Polycarbonate lens and housing
VOLT/AMP	12.8VDC - 0.56A
WT/DIMS	.60 lbs. / 4.25" x 4.25" x 1.75"
WARRANTY	Lifetime LED Warranty



SLL43AB1
SLL43AB2

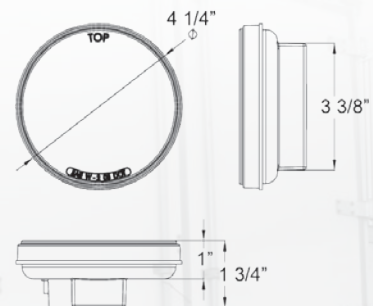

HOLE CUT-OUT: 4.5"



SLL72 SERIES 6" Oval Sealed LED Warning Lamps



SLL72AB1
SLL72AB2

- Sonically sealed, waterproof
- Flashing lights with double-flash function, meeting SAE J595 and J845 standards for Class 2 and Class 3 directional warning lamps
- Use two Function 1 or Function 2 lights for synchronous flashing or pair a Function 1 with a Function 2 light for alternating flash pattern
- Accepts standard PL-3 plugs
- Operating voltage 9-30VDC, suitable for 12V or 24V systems

BULK P/N	POLYPACK P/N	DESCRIPTION	QTY
YELLOW WARNING LAMPS - 22 DIODES			
SLL72AB1	SLL72AB1P	12V-24V Function 1	10
SLL72AB2	SLL72AB2P	12V-24V Function 2	10
SLL72AKB1	SLL72AKB1P	12V-24V Function 1, kit with A70GB & A45PB	10
SLL72AKB2	SLL72AKB2P	12V-24V Function 2, kit with A70GB & A45PB	10
ACCESSORIES			
A70GB	A70GBP	Grommet, 6" oval	50
A45PB	A45PBP	Pigtail, 3-wire	100
A47PB	A47PBP	Right angle pigtail, 3-wire	100

FMVSS	W-2
MATERIALS	Polycarbonate lens and housing
VOLT/AMP	12.8VDC - 0.54A
WT/DIMS	.62 lbs. / 6.5" x 2.375" x 1.75"
WARRANTY	Lifetime LED Warranty

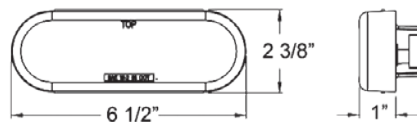

HOLE CUT-OUT: 6.85" x 2.5" (1.25" R)

SLL93 SERIES

7" Round LED Warning Lights for Surface Mount

- 8-LED school bus warning lights
- Acrylic lens, die cast aluminum base plate
- Sealed, waterproof design

BULK P/N	POLYPACK P/N	DESCRIPTION	QTY
RED WARNING LIGHTS - 8 DIODES			
SLL93RB	SLL93RBP	Warning light, 12V	5
YELLOW WARNING LIGHTS - 8 DIODES			
SLL93AB	SLL93ABP	Warning light, 12V	5
ACCESSORIES			
A94VB	A94VBP	Black Steel Visor	25

FMVSS	W2 SAE J887
MATERIALS	Acrylic len, die cast aluminum base
VOLT/AMP	12.8VDC - 2.0A
WT/DIMS	1.3875lb. / 7.25" x 7.25" x 1.9"
WARRANTY	Lifetime LED Warranty

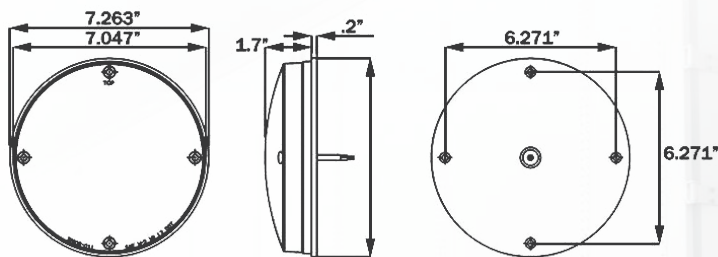

SLL93RB



SLL93AB



SLL93AB with A94VB



RBL10C SERIES LED Dual-Function Strobe/Beacon



RBL10CA

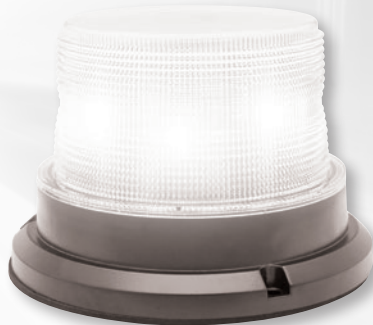

RBL10CC

- Sonically sealed, waterproof
- Five flash patterns
- Surface mount design
- Operating voltage 9-36VDC
- SAE J845/EMC R10 approved

BULK P/N	POLYPACK P/N	DESCRIPTION	QTY
YELLOW BEACON LIGHT - 12 DIODES			
RBL10CA	-	Clear lens, yellow diodes	1
WHITE STROBE LIGHT - 12 DIODES			
RBL10CC	-	Clear lens, white diodes	1

FMVSS	SAE J845 WS3-2
MATERIALS	Polycarbonate lens and housing
VOLT/AMP	12.8VDC - 1.04A / 36VDC - .36A
WT/DIMS	1.53 lbs. / 6.377" x 6.377" x 4.173"
WARRANTY	Lifetime LED Warranty

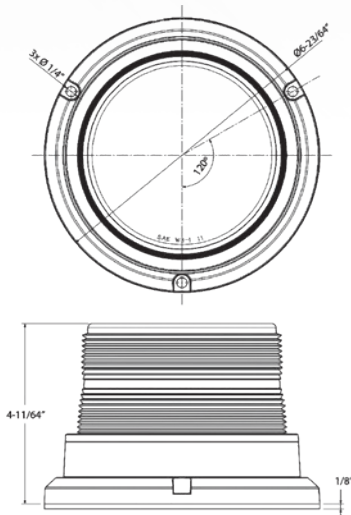

RBL10AS SERIES LED Beacon

- 36-LED array produces bright yellow light
- Dual power: use with 12VDC or 24VDC systems
- Long lasting, energy efficient - diodes last up to 50 times longer than incandescent, draw less than 1/2 amp
- Heavy duty magnetic base mounts securely to metal surfaces
- Durable ABS housing resists corrosion
- 12-ft coil cord with power plug



RBL10AS



BULK P/N	POLYPACK P/N	DESCRIPTION	QTY
YELLOW BEACON - 36 DIODES			
RBL10AS	-	Clam	2

FMVSS	W-2
MATERIALS	ABS base, PMMA lens
VOLT/AMP	10-30VDC - 0.5A
WT/DIMS	.88 lbs - 5.125" x 5.125" x 3.5"
WARRANTY	Lifetime LED Warranty

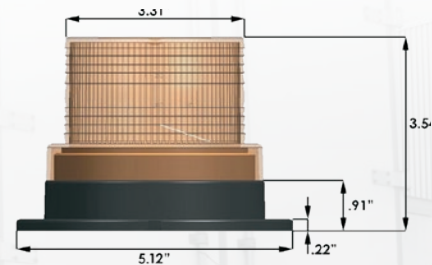

LED WARNING LIGHTS



RBL13/14 SERIES LED Surface Mount, Dual-Function Class 1 Beacon

- Sonically sealed, waterproof
- 30 selectable flash patterns
- Surface mount design
- Operating voltage 9-36VDC
- SAE J845 Class 1
- CA T13 Class B
- Packaged in color retail box



RBL13AB

BULK P/N	POLYPACK P/N	DESCRIPTION	QTY
YELLOW BEACON - 12 DIODES			
RBL13AB	-	5.5", 12-ft. cord, dual switch	1
RBL14AB	-	7", 12-ft. cord, dual switch	1



RBL14AB

FMVSS	SAE J595 Class I
MATERIALS	Polycarbonate lens and housing
VOLT/AMP	12.8VDC - 1.04A / 36VDC - .36A
WT/DIMS	RBL13 - 1.863 lbs. / 6.5" dia x 5.5" RBL14 - 1.863 lbs. / 6.5" dia x 7"
WARRANTY	Lifetime LED Warranty



SLL15 SERIES

Surface Mount LED Class 1 Directional Warning Lights

- Clear lens, ultrabright SMD LED's
- Surface mount design with gasket
- Operating voltage 10-30VDC
- Up to 133 selectable modes
- Synchronize up to eight units
- Meets SAE J595 for Class 1 vehicles
- IP67 rated for dust and water resistance
- Packaged in colorful retail boxes

BULK P/N	POLYPACK P/N	DESCRIPTION	QTY
YELLOW WARNING LIGHT - 6 DIODES			
SLL15AC1B	-	Single color - yellow	1
WHITE WARNING LIGHT - 6 DIODES			
SLL15C1B	-	Single color - white	1
YELLOW/WHITE WARNING LIGHT - 12 DIODES			
SLL15ACC2B	-	Dual color - yellow/white	1
YELLOW/RED/WHITE WARNING LIGHT - 18 DIODES			
SLL15ARC3B	-	Triple color - red/yellow/white	1

FMVSS	SAE J595 - Class 1
MATERIALS	Polycarbonate lens, aluminum housing
VOLT/AMP	12.8VDC - 2.0A Max / 28.0VDC - 1.2A Max
WT/DIMS	.2 lbs. / 5.13" x 0.87" x 0.74"
WARRANTY	Lifetime LED Warranty



SLL15AC1B

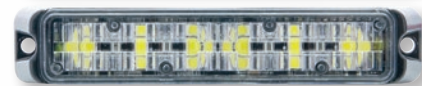

SLL15C1B



SLL15ACC2B



SLL15ARC3B

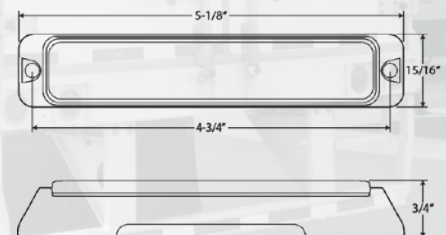



SLL16C1B

SLL16 SERIES

Surface Mount LED, Class 1, Directional Warning Light

- Clear lens, ultrabright LED's
- Surface mount design with gasket
- Operating voltage 10-30VDC
- Up to 72 selectable modes
- Synchronize up to eight units
- Meets SAE J595 for Class 1 vehicles
- IP67 rated for dust and water resistance
- Packaged in colorful retail boxes

BULK P/N	POLYPACK P/N	DESCRIPTION	QTY
WHITE WARNING LIGHT - 6 DIODES			
SLL16C1B	-	Clear lens, white diodes	1

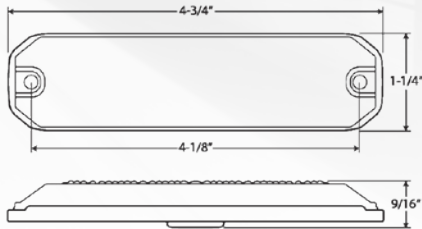

FMVSS	SAE J595 - Class 1
MATERIALS	Polycarbonate lens, aluminum housing
VOLT/AMP	12.8VDC - 1.2A Max / 28.0VDC - 0.6A Max
WT/DIMS	.2 lbs. / 5.13" x 0.87" x 0.74"
WARRANTY	Lifetime LED Warranty

SLL17 SERIES

Surface Mount LED Class 1 Directional Warning Lights

- Clear lens, ultrabright LED's
- Surface mount design with gasket
- Operating voltage 10-30VDC
- Up to 133 selectable modes
- Synchronize up to eight units
- Meets SAE J595 for Class 1 vehicles
- IP67 rated for dust and water resistance
- Packaged in colorful retail boxes

BULK P/N	POLYPACK P/N	DESCRIPTION	QTY
YELLOW WARNING LIGHT - 6 DIODES			
SLL17AC1B	-	Single color - yellow	1
WHITE WARNING LIGHT - 6 DIODES			
SLL17C1B	-	Single color - white	1
YELLOW/WHITE WARNING LIGHT - 12 DIODES			
SLL17ACC2B	-	Dual color - yellow/white	1
YELLOW/RED/WHITE WARNING LIGHT - 18 DIODES			
SLL17ARC3B	-	Triple color - red/yellow/white	1

FMVSS	SAE J595 - Class 1
MATERIALS	Polycarbonate lens, aluminum housing
VOLT/AMP	12.8VDC - 1.2A Max / 28.0VDC - 0.6A Max
WT/DIMS	.2 lbs. / 4.73" x 1.24" x 0.59"
WARRANTY	Lifetime LED Warranty



SLL17AC1B



SLL17C1B



SLL17ACC2B



SLL17ARC3B

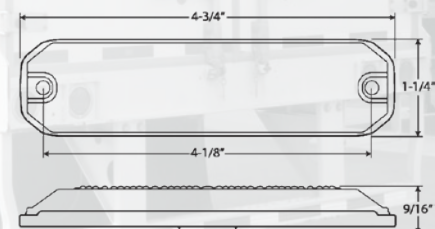

LED WARNING LIGHTS



SLL22ACB

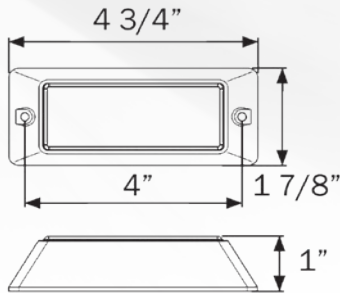

SLL22 SERIES Surface Mount LED Directional Warning Light

- Sonically sealed, waterproof
- Compact, surface mount design with gasket
- 12 flash patterns and synchronization capability: random, steady, single, mega, double, triple, quad, quint, 8-flash, single-quad, single h/l and single-triple quint
- Operating voltage 9-36VDC
- Hard wired; 4-wire, 7" leads
- Wiring - red: positive, black: negative, white: alternating flash, yellow: synchronization and flash pattern change
- Meets SAE J845 for Class II vehicles
- IP67 rating: protected from dust and capable of withstanding water immersion, offering increased reliability and service life

BULK P/N	POLYPACK P/N	DESCRIPTION	QTY
YELLOW WARNING LIGHT - 3 DIODES			
SLL22ACB	SLL22ACBP	Clear lens, yellow diodes	1

FMVSS	SAE J845 Class II
MATERIALS	Polycarbonate lens, ABS trim ring
VOLT/AMP	13.5V - 0.45A
WT/DIMS	.22 lbs / 4.70" x 1.04" x 1.84"
WARRANTY	Lifetime LED Warranty

SLL51 SERIES Surface Mount LED Directional Warning Light

- Sonically sealed, waterproof
- Designed to flash simultaneously
- Operating voltage 9-36VDC
- Surface mount design with gasket
- Hard wired; 3-wire, 7" leads
- Wiring - red: positive, white: negative, yellow: sync
- Meets SAE J845 for Class II vehicles
- IP67 rating: protected from dust and capable of withstanding water immersion, offering increased reliability and service life

BULK P/N	POLYPACK P/N	DESCRIPTION	QTY
YELLOW WARNING LIGHT - 6 DIODES			
SLL51ACB	SLL51ACBP	Clear lens, yellow diodes	40
WHITE WARNING LIGHT - 6 DIODES			
SLL51CB	SLL51CBP	Clear lens, white diodes	40

FMVSS	SAE J845 Class II
MATERIALS	Polycarbonate lens, ABS trim ring
VOLT/AMP	13.5V - 0.33A
WT/DIMS	.49 lbs / 5.54" x 1.67" x 3.67"
WARRANTY	Lifetime LED Warranty



SLL51ACB



SLL51CB

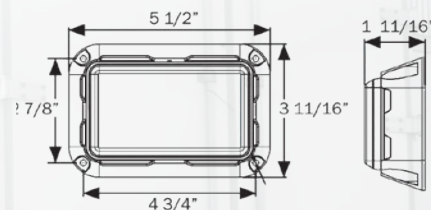



SLL81 SERIES Recess Mount LED Directional Warning Light



SLL81ACB



SLL81CB



- Sonically sealed, waterproof
- Compact, surface mount design with gasket
- 12 flash patterns and synchronization capability: random, single flash, triple flash, mega, double, triplealt, quad, quintalt, flash, single-quad, single h/l and single-triple quint
- Operating voltage 9-36VDC
- Hard wired; 4-wire, 7" leads
- Wiring - red: positive, black: negative, white: alternating flash, yellow: synchronization and flash pattern change
- Meets SAE J845 for Class II vehicles
- IP67 rating: protected from dust and capable of withstanding water immersion, offering increased reliability and service life

BULK P/N	POLYPACK P/N	DESCRIPTION	QTY
YELLOW WARNING LIGHT - 6 DIODES			
SLL81ACB	SLL81ACBP	Clear lens, yellow diodes	100
WHITE WARNING LIGHT - 6 DIODES			
SLL81CB	SLL81CBP	Clear lens, white diodes	100

FMVSS	SAE J845 Class II
MATERIALS	Polycarbonate lens, ABS trim ring
VOLT/AMP	13.5V - 1.3A
WT/DIMS	00.27 lb / 4.36" x 1.55" x 1.69"
WARRANTY	Lifetime LED Warranty

GloLight® M1 SERIES 6.5" LED Marker/Clearance Lights

PATENTED TECHNOLOGY

- Sealed, waterproof design
- Hard wired, includes separate ground wire

BULK P/N	POLYPACK P/N	DESCRIPTION	QTY
YELLOW - 13 DIODES			
11212307B	11212355P	.180 male bullets	50
11212376B	11212356P	Clear lens, .180 male bullets	50
-	11212335P	Kit: .180 male bullets, chrome bezel	10
-	11212336P	Clear lens kit: .180 male bullets, chrome bezel	10
RED - 13 DIODES			
11212309B	11212357P	.180 male bullets	50
11212378B	11212358P	Clear lens, .180 male bullets	50
-	11212337P	Kit: .180 male bullets, chrome bezel	10
-	11212338P	Clear lens kit: .180 male bullets, chrome bezel	10
ACCESSORIES			
00212317B	00212327P	Bezel	200/20

FMVSS	P2
MATERIALS	Polycarbonate lens, housing and bezel
VOLT/AMP	12.8VDC - 0.12A
WT/DIMS	.132 lbs. / 6.625" x 2.188" x 1"
WARRANTY	Three Year Warranty

GloLight

Panelite
MILLENNIUM SERIES™



M1 LED WITH BEZEL



M1 CLEAR LENS LED WITH BEZEL

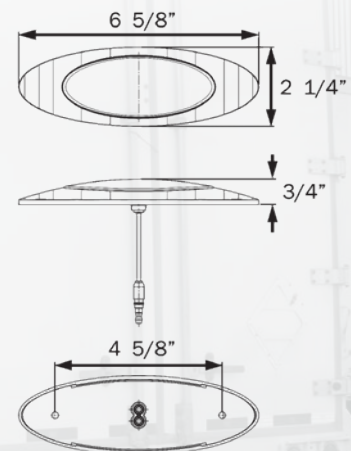

HOLE CUT-OUT: 1.5"

GloLight

Panelite
MILLENNIUM SERIES™

GloLight® M3 SERIES 3" LED Marker/Clearance Lights

PATENTED TECHNOLOGY

- Sealed, waterproof design
- Hard wired, includes separate ground wire



M3 LED WITH BEZEL



M3 CLEAR LENS LED WITH BEZEL

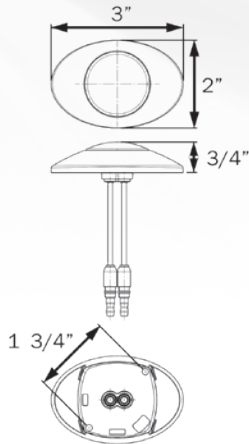

HOLE CUT-OUT:
1.375"

BULK P/N	POLYPACK P/N	DESCRIPTION	QTY
YELLOW - 5 DIODES			
11212207B	11212255P	.180 male bullets	50
11212276B	11212256P	Clear lens, .180 male bullets	50
-	11212235P	Kit: .180 male bullets with chrome bezel	10
-	11212236P	Clear lens kit: .180 male bullets with chrome bezel	10
RED - 5 DIODES			
11212209B	11212257P	.180 male bullets	50
11212278B	11212258P	Clear lens, .180 male bullets	50
-	11212237P	Kit: .180 male bullets with chrome bezel	10
-	11212238P	Clear lens kit: .180 male bullets with chrome bezel	10
ACCESSORIES			
00212217B	00212227P	Bezel	500/20

FMVSS	P2
MATERIALS	Polycarbonate lens, housing and bezel
VOLT/AMP	12.8VDC - 0.12A
WT/DIMS	.132 lbs. / 3" x 2" x 1"
WARRANTY	Three Year Warranty

GloLight® M5 SERIES 4" LED Marker/Clearance Lights

PATENTED TECHNOLOGY

- Sealed, waterproof design
- Hard wired, includes separate ground wire

BULK P/N	POLYPACK P/N	DESCRIPTION	QTY
YELLOW - 6 DIODES			
11212700B	11212708P	.180 male bullets	10
11212700BB	11212700BBP	Blunt cut leads	10
11212702B	11212710P	Clear lens, .180 male bullets	10
-	11212704P	Kit: .180 male bullets with chrome bezel	10
-	11212706P	Clear lens kit: .180 male bullets with chrome bezel	10
RED - 6 DIODES			
11212701B	11212709P	.180 male bullets	10
11212703B	11212711P	Clear lens, .180 male bullets	10
-	11212705P	Kit: .180 male bullets with chrome bezel	10
-	11212707P	Clear lens kit: .180 male bullets with chrome bezel	10
ACCESSORIES			
00212717B	00212727P	Bezel	500/20

FMVSS	P2
MATERIALS	Polycarbonate lens, housing and bezel
VOLT/AMP	12.8VDC - 0.033A
WT/DIMS	.066 lb. / 4.156" x 1.5" x .75"
WARRANTY	Three Year Warranty

GloLight

Panelite
MILLENNIUM SERIES™



M5 LED WITH BEZEL



M5 CLEAR LENS LED WITH BEZEL

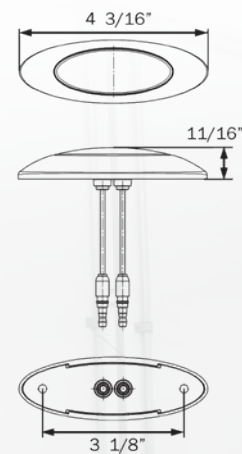

HOLE CUT-
OUT: 1"



M1 SERIES Millennium Series® 6.5" Sealed LED Marker/Clearance Lights

- Sealed, waterproof design
- Hard wired, includes separate ground wire
- Available with .180 male bullets or metripack connector
- Choose from light only or kit with chrome bezel



M1 LED WITH BEZEL



M1 CLEAR LENS LED WITH BEZEL



M1 LED WITH BEZEL



M1 CLEAR LENS LED WITH BEZEL

BULK P/N	POLYPACK P/N	DESCRIPTION	QTY
YELLOW - 4 DIODES			
00212307B	00212355P	.180 male bullets	50
-	00212335P	Kit: .180 male bullets, bezel	10
-	00212345P	Kit: Metripack connector, bezel	10
-	00212365P	Kit: Packard connector, bezel	10
00212376B	00212356P	Clear lens, .180 male bullets	10
-	00212336P	Kit: Clear lens, .180 male bullets, bezel	10
-	00212346P	Kit: Clear lens, metripack connector, bezel	10
RED - 4 DIODES			
00212309B	00212357P	.180 male bullets	50
00212316B	00212367P	Metripack connector	100
-	00212337P	Kit: .180 male bullets, bezel	10
-	00212347P	Kit: Metripack connector, bezel	10
00212378B	00212358P	Clear lens, .180 male bullets	50
00212386B	00212368P	Clear lens, metripack connector	100
-	00212338P	Kit: Clear lens, .180 male bullets, bezel	10
ACCESSORIES			
00212317B	00212327P	Bezel	200/20



FMVSS	P2
MATERIALS	Polycarbonate lens, housing and bezel
VOLT/AMP	12.8VDC - 0.12A
WT/DIMS	.132 lbs. / 6.625" x 2.188" x 1"
WARRANTY	Three Year Warranty

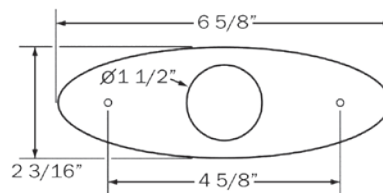

HOLE CUT-OUT: 1.5"

M3 SERIES Millennium Series® 3" Sealed LED Marker/Clearance Lights

- Sealed, waterproof design
- Hard wired, includes separate ground wire
- Available with .180 male bullets or metripack connector
- Choose from light only or kit with chrome bezel

BULK P/N	POLYPACK P/N	DESCRIPTION	QTY
YELLOW - 2 DIODES			
00212207B	00212255P	.180 male bullets	50
-	00212235P	Kit: .180 male bullets, bezel	10
00212276B	00212256P	Clear lens, .180 male bullets	50
00212213B	00212263P	Clear lens, metripack connector	50
-	00212236P	Kit: Clear lens, .180 male bullets, bezel	10
RED - 2 DIODES			
00212209B	00212257P	.180 male bullets	50
-	00212237P	Kit: .180 male bullets, bezel	10
00212278B	00212258P	Clear lens, .180 male bullets	50
-	00212238P	Kit: Clear lens, .180 male bullets, bezel	10
ACCESSORIES			
00212217B	00212227P	Bezel	500/20

FMVSS	P2
MATERIALS	Polycarbonate lens, housing and bezel
VOLT/AMP	12.8VDC - 0.36A
WT/DIMS	.132 lbs. / 3" x 2" x 1"
WARRANTY	Three Year Warranty

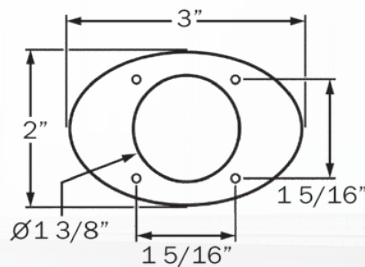

HOLE CUT-OUT: 1.375"



M3 LED WITH BEZEL



M3 CLEAR LENS LED WITH BEZEL



M3 LED WITH BEZEL



M3 CLEAR LENS LED WITH BEZEL





M4 SERIES Millennium Series® 9" Sealed LED Lights

- Sealed, waterproof design
- Hard wired, includes separate ground wire
- Chrome trim ring included in kits or available separately

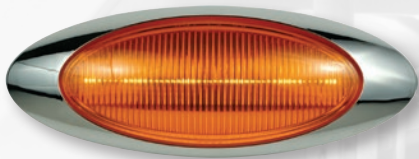

M4 LED MARKER/CLEARANCE LIGHTS WITH BEZEL

BULK P/N	POLYPACK P/N	DESCRIPTION	QTY
YELLOW MARKER/CLEARANCE - 6 DIODES			
00212104B	00212155P	.180 male bullets	10
-	00212135P	Kit: .180 male bullets, bezel	10
RED MARKER/CLEARANCE - 6 DIODES			
-	00212157P	.180 male bullets	10
-	00212137P	Kit: .180 male bullets, bezel	10
ACCESSORIES			
00212117B	00212127P	Bezel	70/20

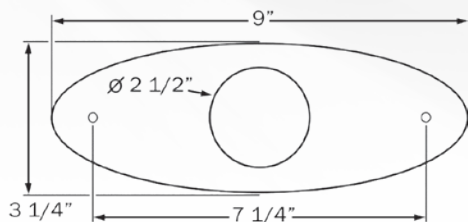

HOLE CUT-OUT: 2.5"

FMVSS	P2
MATERIALS	Polycarbonate lens, housing and bezel
VOLT/AMP	12.8VDC - 0.090A
WT/DIMS	.132 lbs. / 9" x 3.25" x 1"
WARRANTY	Three Year Warranty

M5 SERIES

Millennium Series® 4" Sealed LED Marker/Clearance Lights

- Sealed, waterproof design
- Hard wired, includes separate ground wire
- Available with .180 male bullets or metripack connector
- Choose from light only or kit with chrome bezel

BULK P/N	POLYPACK P/N	DESCRIPTION	QTY
YELLOW - 3 DIODES			
00212700B	00212708P	.180 male bullets	10
00212702B	00212710P	Clear lens, .180 male bullets	10
-	00212704P	Kit: .180 male bullets, bezel	10
-	00212706P	Kit: Clear lens, .180 male bullets, bezel	10
-	00212712P	Clear lens, metripack connector	10
RED - 3 DIODES			
00212701B	00212709P	.180 male bullets	10
00212703B	00212711P	Clear lens, .180 male bullets	10
-	00212705P	Kit: .180 male bullets, bezel	10
-	00212707P	Kit: Clear lens, .180 male bullets, bezel	10
ACCESSORIES			
00212717B	00212727P	Bezel	500/20

FMVSS	P2
MATERIALS	Polycarbonate lens, housing and bezel
VOLT/AMP	12.8VDC - 0.033A
WT/DIMS	.066 lb. / 4.156" x 1.5" x .75"
WARRANTY	Three Year Warranty

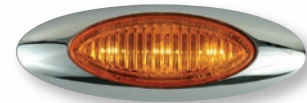
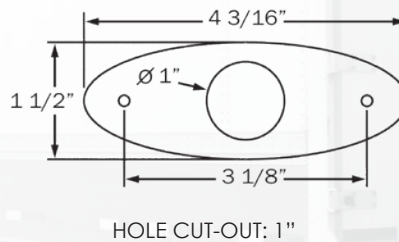

M5 LED WITH BEZEL



M5 CLEAR LENS LED WITH BEZEL



M5 LED WITH BEZEL



M5 CLEAR LENS LED WITH BEZEL





MCL11S SERIES 3/4" Sealed LED Marker/Clearance Lights with Theft-Deterrent Design



PATENTED TECHNOLOGY

- Sealed, waterproof design
- Recess mount lights with theft-deterrent mounting design
- Easy to install: insert light into mounting hole and secure with locking ring
- PC rated: fulfills requirement for marker and clearance light when properly mounted



MCL11SAB



MCL11SRB



MCL11SACKB



MCL11SRCKB



A11SRB

BULK P/N	POLYPACK P/N	DESCRIPTION	QTY
YELLOW - 1 DIODE			
MCL11SAB	MCL11SABP	Light with gasket, .180 bullets	50
MCL11SAKB	MCL11SAKBP	Light with gasket & locking ring .180 bullets	50
MCL11SAK1B	MCL11AK1BP	Light with gasket and locking ring	50
MCL11SACKB	MCL11SACKBP	Clear lens, yellow diodes with gasket & locking ring, .180 bullets	50
RED - 1 DIODE			
MCL11SRB	MCL11SRBP	Light with gasket, .180 bullets	50
MCL11SRKB	MCL11SRKBP	Light with gasket & locking ring .180 bullets	50
MCL11SRK1B	MCL11SRK1BP	Light with gasket and locking ring	50
MCL11SRCKB	MCL11SRCKBP	Clear lens, red diodes with gasket & locking ring, .180 bullets	50
ACCESSORIES			
A11SRB	A11SRBP	Stainless steel locking ring	100

FMVSS	PC
MATERIALS	Polycarbonate lens and housing, stainless steel locking ring, EPDM rubber gasket
VOLT/AMP	12.8VDC - .082A
WT/DIMS	.10 lbs. / 1" x 1" x .875"
WARRANTY	Lifetime LED Warranty

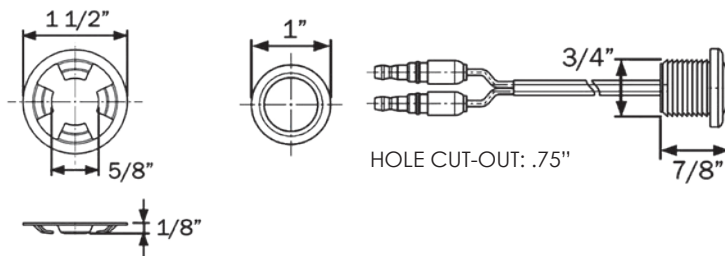

MCL110 SERIES GloLight® Uni-Lite™ 3/4" LED Non-Directional Marker/Clearance Lights



PATENTED TECHNOLOGY

- Sealed, waterproof design
- PC rated when mounted in any direction - 360 degrees!
- Hard wired, includes separate ground wire
- Choose from light only or kit with A11GB grommet

BULK P/N	POLYPACK P/N	DESCRIPTION	QTY
YELLOW - PC RATED - 2 DIODES			
MCL110AB	MCL110ABP	Light only	50
MCL110AKB	MCL110AKBP	Light with A11GB grommet	50
MCL110AKBF	MCL110AKBFP	Light kit with grommet, .156 female barrels on 8" leads	50
RED - PC RATED - 2 DIODES			
MCL110RB	MCL110RBP	Light only	50
MCL110RKB	MCL110RKBP	Light with A11GB grommet	50
MCL110RKBF	MCL110RKBF	Light kit with grommet, .156 female barrels on 8" leads	50
ACCESSORIES			
A11AXB	A11AXBP	Yellow reflector	100
A11RXB	A11RXBP	Red reflector	100
A11GB	A11GBP	Grommet	100
A12GB	A12GBP	Sealing grommet, .070-.125"	100
A14GB	A14GBP	Sealing grommet, .125-.250"	100
A11PB	A11PBP	Black plastic snap-in flange	100
A11CRB	A11CRBP	Chrome finish grommet cover	120
A11SSB	A11SSBP	Stainless steel grommet cover	120

FMVSS	PC
MATERIALS	Polycarbonate lens and housing
VOLT/AMP	12.8VDC - 0.052A
WT/DIMS	.022 lbs. / .073" x .073" x 0.938"
WARRANTY	Lifetime LED Warranty



MCL110AB



MCL110RB



MCL110AKB



MCL110RKB

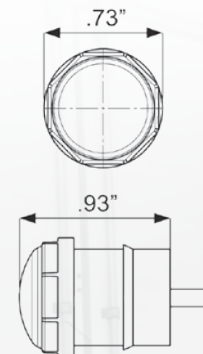

A11RXB

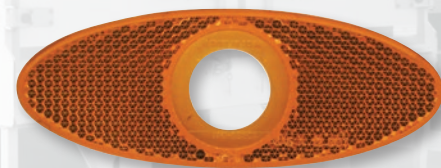

A11AXB

LED SEALED MARKER/
CLEARANCE LIGHTS

GloLight

MCL111 SERIES

GloLight® Uni-Lite™ 3/4" Sealed LED Marker/Clearance Lights



PATENTED TECHNOLOGY

- Sealed, waterproof design
- PC rated two diode models
- Hard wired, includes separate ground wire
- Choose from light only or kit with A11GB grommet
- Dual function models MCL121AK9PVG/RK9PVG provide a supplemental stop/turn function



MCL111AKB



MCL111RKB

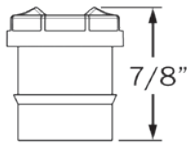
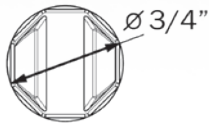

A11PB

BULK P/N	POLYPACK P/N	DESCRIPTION	QTY
YELLOW - PC RATED - 2 DIODES			
MCL111AB	MCL111ABP	Light only	50
MCL111AKB	MCL111AKBP	Light with A11GB grommet	50
MCL111AKPG	MCL111AKPGP	Kit with .180 male bullets, A11GB	50
MCL121AK9PVG	MCL121AK9PVG	Supplemental turn - kit with closed grommet, .180 male bullets	20
RED - PC RATED - 2 DIODES			
MCL111RB	MCL111RBP	Light only	50
MCL111RKB	MCL111RKBP	Light with A11GB grommet	50
MCL111RKPG	MCL111RKPGP	Kit with .180 male bullets, A11GB	50
MCL121RK9PVG	MCL121RK9PVG	Supplemental turn - kit with closed grommet, .180 male bullets	20
ACCESSORIES			
A11AXB	A11AXBP	Yellow reflector	100
A11RXB	A11RXBP	Red reflector	100
A11GB	A11GBP	Grommet	100
A12GB	A12GBP	Sealing grommet, .070-.125"	100
A14GB	A14GBP	Sealing grommet, .125-.250"	100
A11PB	A11PBP	Black plastic snap-in flange	100
A11CRB	A11CRBP	Chrome finish grommet cover	120
A11SSB	A11SSBP	Stainless steel grommet cover	120

FMVSS	PC
MATERIALS	Polycarbonate lens and housing
VOLT/AMP	12.8VDC - 0.04A
WT/DIMS	.022 lbs. / .75" x .75" x 0.875"
WARRANTY	Lifetime LED Warranty

MCL112 SERIES

GloLight® Uni-Lite™ 3/4" Sealed LED Marker/Clearance Lights



LED SEALED MARKER/
CLEARANCE LIGHTS

PATENTED TECHNOLOGY

- Sealed, waterproof design
- P2 rated single diode models
- Hard wired, includes separate ground wire
- Choose from light only or kit with A11GB grommet



MCL112AKB



MCL112RKB

BULK P/N	POLYPACK P/N	DESCRIPTION	QTY
YELLOW - P2 RATED - 1 DIODE			
MCL112AKB	MCL112AKBP	Light with A11GB grommet	50
RED - P2 RATED - 1 DIODE			
MCL112RB	MCL112RBP	Light only	50
MCL112RKB	MCL112RKBP	Light with A11GB grommet	50
ACCESSORIES			
A11AXB	A11AXBP	Yellow reflector	100
A11RXB	A11RXBP	Red reflector	100
A11GB	A11GBP	Grommet	100
A12GB	A12GBP	Sealing grommet, .070-.125"	100
A14GB	A14GBP	Sealing grommet, .125-.250"	100
A11PB	A11PBP	Black plastic snap-in flange	100
A11CRB	A11CRBP	Chrome finish grommet cover	120
A11SSB	A11SSBP	Stainless steel grommet cover	120

FMVSS	P2
MATERIALS	Polycarbonate lens and housing
VOLT/AMP	12.8VDC - .075A
WT/DIMS	.022 lbs. / .75" x .75" x 0.875"
WARRANTY	Lifetime LED Warranty

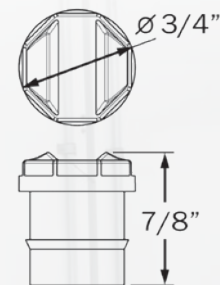



MCL10 SERIES Uni-Lite™ 3/4" LED Non-Directional Marker/Clearance Lights



MCL10AB



MCL10AKB



MCL10ACKB

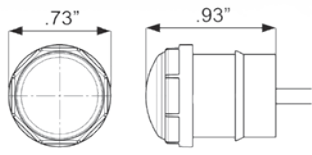

HOLE CUT-OUT: .75"

- Sonically sealed, waterproof
- PC rated when mounted in any direction - 360 degrees!
- Hard wired, includes separate ground wire

BULK P/N	POLYPACK P/N	DESCRIPTION	QTY
YELLOW - 1 DIODE			
MCL10AB	MCL10ABP	Light only	50
MCL10AKB	MCL10AKBP	Light with A11GB grommet	50
MCL10AK1224B	MCL10AK1224BP	Light with A11GB grommet, 12/24V	50
MCL10AKA12B	MCL10AKA12BP	Light with A12GB grommet, 7.5-in. leads	50
MCL10AKL12B	MCL10AKL12BP	Light with A12GB grommet, 12-in. leads	50
MCL10AK12JPG	MCL10AK12JPGP	Light with A11GB grommet, 12-in. leads, .156 male bullets	50
MCL10AKL12PG	MCL10AKL12PGP	Light with A11GB grommet, 12-in. leads, .180 male bullets	50
MCL10AKL12PGN	MCL10AKL12PGNP	Light with A12GB grommet, 12-in. leads, .180 male bullets	50
MCL10AKL18JPG	MCL10AKL18JPGP	Light with A12GB grommet, 18-in. leads, .180 male bullets	50
MCL10AKA10PG	MCL10AKA10PGP	Light with A10GB grommet, .180 male bullets	50
MCL10AK1FPG	MCL10AK1FPGP	Light with A12GB grommet, .156 female barrels	50
MCL10ACKB	MCL10ACKBP	Clear lens with A11GB grommet	50
MCL10ACKA12B	MCL10ACKA12BP	Clear lens with A12GB grommet	50
MCL10CAK14B	MCL10CAK14BP	Clear lens with grommet, 14-in. leads	50
MCL10ACKPG	MCL10ACKPGP	Clear lens with A11GB grommet .180 male bullets	50
MCL10ACKA12PG	MCL10ACKA12PGP	Clear lens with A12GB grommet, .180 male bullets	50
MCL10ACK12JPG	MCL10ACK12JPGP	Clear lens light with A11GB grommet, 12-in. leads, .156 male bullets	50

FMVSS	PC
MATERIALS	Polycarbonate lens and housing
VOLT/AMP	12.8VDC - 0.52A
WT/DIMS	.022 lbs. / .073" x .073" x .938"
WARRANTY	Lifetime LED Warranty

MCL10 SERIES

Uni-Lite™ 3/4" LED Non-Directional Marker/Clearance Lights



- Sonically sealed, waterproof
- PC rated when mounted in any direction - 360 degrees!
- Hard wired, includes separate ground wire

BULK P/N	POLYPACK P/N	DESCRIPTION	QTY
RED - 1 DIODE			
MCL10RB	MCL10RBP	Light only	50
MCL10RKB	MCL10RKBP	Light with A11GB grommet	50
MCL10RK1224B	MCL10RK1224BP	Light with A11GB grommet, 12/24V	50
MCL10RKA12B	MCL10RKA12BP	Light with A12GB grommet, 7.5-in. leads	50
MCL10RKL12B	MCL10RKL12BP	Light with A12GB grommet, 12-in. leads	50
MCL10RK12JPG	MCL10RK12JPGP	Light with A11GB grommet, 12-in. leads, .156 male bullets	50
MCL10RKL12PG	MCL10RKL12PGP	Light with A11GB grommet, 12-in. leads, .180 male bullets	50
MCL10RKL12PGN	MCL10RKL12PGNP	Light with A12GB grommet, 12-in. leads, .180 male bullets	50
MCL10RKL18JPG	MCL10RKL18JPGP	Light with A12GB grommet, 18-in. leads, .180 male bullets	50
MCL10RKA10PG	MCL10RKA10PGP	Light with A10GB grommet, .180 male bullets	50
MCL10RKDTPG	MCL10RKDTPGP	Light with A11GB grommet, .180 male bullets, three-wire	20
MCL10RK1FPG	MCL10RK1FPGP	Light with A12GB grommet, .156 female barrels	50
MCL10RCKB	MCL10RCKBP	Clear lens with A11GB grommet	50
MCL10RCKA12B	MCL10RCKA12BP	Clear lens with A12GB grommet	50
MCL10CRK14B	MCL10CRK14BP	Clear lens with grommet, 14-in. leads	50
MCL10RCKA12PG	MCL10RCKA12PGP	Clear lens with A12GB grommet, .180 male bullets	50
MCL10RCKPG	MCL10RCKPGP	Clear lens with A11GB grommet, .180 male bullets	50
MCL10RCK12JPG	MCL10RCK12JPGP	Clear lens light with A11GB grommet, 12-in. leads, .156 male bullets	50

FMVSS	PC
MATERIALS	Polycarbonate lens and housing
VOLT/AMP	12.8VDC - 0.52A
WT/DIMS	.022 lbs. / .073" x .073" x .938"
WARRANTY	Lifetime LED Warranty



MCL10RB



MCL10RKB



MCL10RCKB

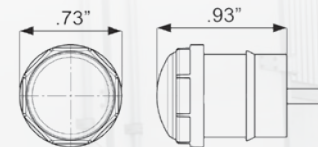

HOLE CUT-OUT: .75"

LED SEALED MARKER/
CLEARANCE LIGHTS



MCL11 SERIES

Uni-Lite™ 3/4" Sealed LED Marker/Clearance Lights



- Sealed, waterproof design
- Hard wired, includes separate ground wire



MCL11AB



MCL11RB



MCL11AKB



MCL11RKB

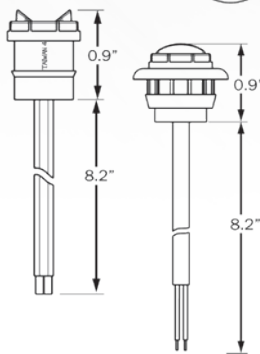

HOLE CUT-OUT: 0.75"

FMVSS PC

MATERIALS

Polycarbonate lens and housing

VOLT/AMP

12.8VDC - 0.03A

WT/DIMS

.022 lbs. / .074" x .074" x 0.90"

WARRANTY

Lifetime LED Warranty

BULK P/N	POLYPACK P/N	DESCRIPTION	QTY
YELLOW - PC RATED - 2 DIODES			

MCL11AB	MCL11ABP	Light only	50
MCL11APG	MCL11APGP	Light with .180 male bullets	50
MCL11AKB	MCL11AKBP	Kit with A11GB grommet	50
MCL11AK12B	MCL11AK12BP	Kit with A11GB grommet, 12" leads	50
MCL11A24KB	MCL11A24KBP	Kit with A11GB grommet, 24V, 24" leads	50
MCL11AHPG	MCL11AHPGP	Kit with .180 male bullets, A11GB	50
MCL11AKPVG	MCL11AKPVG	Kit with sealed grommet, .180 male bullets	50
MCL11AK12PG	MCL11AK12PGP	Kit with 12" leads, A11GB, .156 male bullets	50
MCL11AKBF	MCL11AKBFP	Kit with .156 female barrels, A11GB	50
MCL11AKAB	MCL11AKABP	Kit with .156 female barrels, A11GB	50
MCL11AKPRB	MCL11AKPRBP	Kit with A11GB, .150 female barrels, 2.5" leads	50
MCL11CAB	MCL11CABP	Light only, clear lens	50
MCL11CAKB	MCL11CAKBP	Kit with A11GB, clear lens	50
MCL11CAKPG	MCL11CAKPGP	Kit with A11GB, clear lens, .180 male bullets	50
MCL11CAKBF	MCL11CAKBFP	Kit with A11GB, clear lens, .156 female barrels	50
MCL21AKRGVB	MCL21AKRGVBP	Assembly: (2) MCL11, sealing grommets, ring terminals on 262-in. 3-wire	10
MCL21AKRYVB	MCL21AKRYVBP	Assembly: (2) MCL11, sealing grommets, ring terminals on 190-in. 3-wire	10

RED - PC RATED - 2 DIODES			
MCL11RB	MCL11RBP	Light only	50
MCL11RPG	MCL11RPGP	Light with .180 male bullets	50
MCL11RKB	MCL11RKBP	Kit with A11GB grommet	50
MCL11RK12B	MCL11RK12BP	Kit with 12" leads, A11GB	50
MCL11R24KB	MCL11R24KBP	Kit with A11GB grommet, 24V, 24" leads	50
MCL11RK12PG	MCL11RK12PGP	Kit with 12" leads, A11GB, .156 male bullets	50
MCL11RHPG	MCL11RHGP	Kit with .180 male bullets, A11GB	50
MCL11RKPVG	MCL11RKPVG	Kit with sealed grommet, .180 male bullets	50
MCL11RKBF	MCL11RKBFP	Kit with .156 female barrels, A11GB	50
MCL11RKAB	MCL11RKABP	Kit with .156 female connectors, A11GB	50
MCL11CRB	MCL11CRBP	Light only, clear lens	50
MCL11CRKB	MCL11CRKBP	Kit with A11GB, clear lens	50
MCL11CRKPG	MCL11CRKPGP	Kit with A11GB, clear lens, .180 male bullets	50
MCL11CRKBF	MCL11CRKBFP	Kit with A11GB, clear lens, .156 female barrels	50
MCL11RKPV4G	MCL11RKPV4GP	Kit with sealed grommet, female amp connector	50
MCL21RKPVG	MCL21RKPVG	Kit with sealed grommet, 12-ft. leads, .180 male bullets	10
MCL21RKPV4G	MCL21RKPV4GP	Assembly: (2) MCL11, sealing grommets, ring terminals on 262-in. 3-wire	10

See Accessories section at back of catalog or listing on previous pages for additional mounting options

MCL12 SERIES

Uni-Lite™ 3/4" Sealed LED Marker/Clearance Lights - P2

- Sealed, waterproof, P2 rated single diode models
- Hard wired, includes separate ground wire
- Three-piece identification light harnesses available; optional supplemental turn function
- MCL922RB is three-piece identification light bar

BULK P/N	POLYPACK P/N	DESCRIPTION	QTY
YELLOW - P2 RATED - 1 DIODE			
MCL12AB	MCL12ABP	Light only	50
MCL12AKB	MCL12AKBP	Light kit with A11GB	50
MCL12AKPG	MCL12AKPGP	Light kit with .180 male bullets, A11GB	50
RED - P2 RATED - 1 DIODE			
MCL12RB	MCL12RBP	Light only	50
MCL12RKB	MCL12RKBP	Light kit with A11GB	50
MCL12RKPG	MCL12RKPGP	Light kit with .180 male bullets, A11GB	50
RED IDENTIFICATION LIGHT KIT WITH MOLDED HARNESS			
MCL12RK3B	MCL12RK3BP	(3) red MCL12 lights	20
MCL12RK3RMB	MCL12RK3RMBP	(3) red MCL12 lights, weathertight plug	20
MCL22RK3B	MCL22RK3BP	(3) red MCL12 lights, supplemental turn function	20
MCL22RK4B	MCL22RK4BP	(3) red MCL12 lights, supplemental turn function, amp connector	20
RED IDENTIFICATION LIGHT BAR			
MCL922RB	MCL922RBP	(3) red MCL12 lights, molded bar, black	10
ACCESSORIES			
A11AXB	A11AXBP	Yellow reflector	100
A11RXB	A11RXBP	Red reflector	100
A11GB	A11GBP	Grommet	100
A12GB	A12GBP	Sealing grommet, .070-.125"	100
A14GB	A14GBP	Sealing grommet, .125-.250"	100
A11PB	A11PBP	Black plastic snap-in flange	100
A11CRB	A11CRBP	Chrome finish grommet cover	120
A11SSB	A11SSBP	Stainless steel grommet cover	120
RETAIL			
MCL12AK		Yellow light kit, card/slipover blister	12
MCL12RK		Red light kit, card/slipover blister	12



MCL12AKB

MCL12RKB



MCL12RK3B



MCL922RB

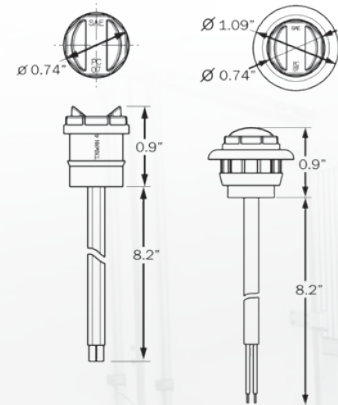

HOLE CUT-OUT: 0.75"

FMVSS P2

MATERIALS

Polycarbonate lens and housing

VOLT/AMP

12.8VDC - 0.47A

WT/DIMS

.022 lbs. / .074" x .074" x 0.90"

WARRANTY

Lifetime LED Warranty

LED SEALED MARKER/
CLEARANCE LIGHTS



MCL12AR SERIES Uni-Lite™ 3/4" Sealed LED Fender Lights



MCL12ARRB
MCL12ARLB

- Sealed, waterproof, P2 rated single diode lights pre-installed in durable ABS, surface mount bracket
- Hard wired, includes separate ground wire
- Available with clear or tinted lenses



BULK P/N	POLYPACK P/N	DESCRIPTION	QTY
		YELLOW / RED FENDER LIGHTS	
MCL12ARLB	MCL12ARLBP	Driver side assembly, 2-wire	50
MCL12ARRB	MCL12ARRBP	Passenger side assembly, 2-wire	50
MCL12CA2RLB	MCL12CA2RLBP	Clear lens, driver side assembly, self grounding	50
MCL12CA2RRB	MCL12CA2RRBP	Clear lens, passenger side assembly, self grounding	50
ACCESSORIES			
A11GB	A11GBP	Grommet	100

FMVSS	P2
MATERIALS	Polycarbonate lens and housing
VOLT/AMP	12.8VDC - 0.047A
WT/DIMS	.20 lbs. / 4.75" x 1.625" x 1.25"
WARRANTY	Lifetime LED Warranty



MCL12CA2RLB
MCL12CA2RRB

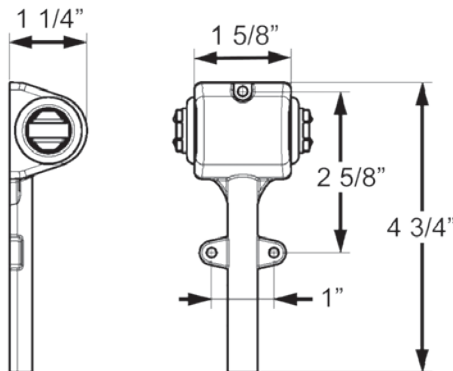

MCL21/23 SERIES 2" & 2.5" Sealed LED Beehive Style Marker/Clearance Lights

- Sonically sealed, waterproof
- Clearance, side marker, or rear tracking light applications
- Accepts standard two-pin PL-10 plug

BULK P/N	POLYPACK P/N	DESCRIPTION	QTY
YELLOW - 8 DIODES			
MCL21AB	MCL21ABP	2" light	20
MCL23AB	MCL23ABP	2.5" light	20
RED - 8 DIODES			
MCL21RB	MCL21RBP	2" light	20
MCL23RB	MCL23RBP	2.5" light	20
ACCESSORIES			
A46PB	A46BPB	Straight PL-10 plug, 6" lead	100
A86PB	A86BPB	Straight PL-10 plug, 18" lead	100
A54GB	A54GBP	2" Flush mount grommet	100
A54GK	A54GKP	2" Kit: A54GB and A46PB	100
A55CB	A55CBP	2" Chrome trim ring	20
A55GB	A55GBP	2.5" Flush mount grommet (open back)	50
A56GB	A56GBP	2.5" Recess mount grommet (closed back)	100
A57GB	A57GBP	2.5" Recess mount grommet (open back)	50
A55GK	A55GKP	2.5" Kit: A55GB and A46PB	100
A57GK	A57GKP	2.5" Kit: A57GB and A46PB	100
A57CB	A57CBP	2.5" Chrome trim ring	20
BK5557GB	BK5557GBP	2"/2.5" Cam-on mounting bracket	50

FMVSS	P2
MATERIALS	Polycarbonate lens and housing
VOLT/AMP	MCL21: 12.8VDC - 0.061A MCL23: 12.8VDC - 0.051A
WT/DIMS	MCL21: .110 lbs. / 2" x 2" x 1.75" MCL23: .176 lbs. / 2.5" x 2.5" x 2.313"
WARRANTY	Lifetime LED Warranty



MCL21AB



MCL21RB



MCL23AB



MCL23RB



MCL21 SERIES
HOLE CUT-OUT: 2.313"

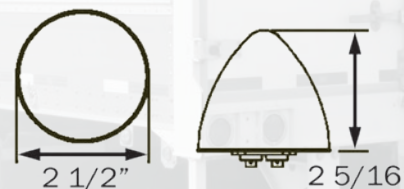

MCL23 SERIES
HOLE CUT-OUT: 2.75"

LED SEALED MARKER/
CLEARANCE LIGHTS



MCL155 SERIES GloLight® 2" Round Sealed LED Marker/Clearance Lights

PATENTED TECHNOLOGY

- Sonically sealed, waterproof
- Accepts standard two-pin PL-10 plug
- Recess grommet mount design



MCL155AB



MCL155RB

BULK P/N	POLYPACK P/N	DESCRIPTION	QTY
YELLOW - 6 DIODES			
MCL155AB	MCL155ABP	Grommet mount	20
RED - 6 DIODES			
MCL155RB	MCL155RBP	Grommet mount	20
ACCESSORIES			
A46PB	A46PBP	Straight PL-10 plug, 6" lead	100
A86PB	A86PBP	Straight PL-10 plug, 18" lead	100
A54GB	A54GBP	2" Flush mount grommet	100
A54GK	A54GKP	2" Kit: A54GB and A46PB	100
A55CB	A55CBP	2" Chrome trim ring	20
BK5557GB	BK5557GBP	Cam-on mounting bracket	50

FMVSS	P2
MATERIALS	Polycarbonate lens and housing
VOLT/AMP	12.8VDC - 0.06A
WT/DIMS	Grommet Mount: .066 lbs. / 2" x 2" x 1" Flange Mount: .078 lbs. / 2.938" x 2.938" x .938"
WARRANTY	Lifetime LED Warranty

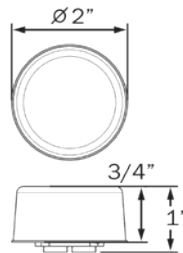

MCL155AB/RB

HOLE CUT-OUT: 2.313"

MCL55 SERIES 2" Round Sealed LED Marker/Clearance Lights

- Sonically sealed, waterproof
- Accepts standard two-pin PL-10 plug
- Available in 12V and 12-24V models

BULK P/N	POLYPACK P/N	DESCRIPTION	QTY
YELLOW - 3 DIODES			
MCL55AB	MCL55ABP	Grommet mount, 12V	20
MCL55ACB	MCL55ACBP	Clear lens grommet mount, 12V	20
MCL55A1224B	MCL55A1224BP	Grommet mount, 12-24V	20
RED - 3 DIODES			
MCL55RB	MCL55RBP	Grommet mount, 12V	20
MCL55RCB	MCL55RCBP	Clear lens grommet mount, 12V	20
MCL55R1224B	MCL55R1224BP	Grommet mount, 12-24V	20
MCL55FRB	MCL55FRBP	Flange mount, 12V	50
UTILITY LIGHT - 3 DIODES			
UCL55CB	UCL55CBP	White LED, 12V	20
ACCESSORIES			
A46PB	A46PBP	Straight PL-10 plug, 6" lead	100
A86PB	A86PBP	Straight PL-10 plug, 18" lead	100
A54GB	A54GBP	2" Flush mount grommet	100
A54GK	A54GKP	2" Kit: A54GB and A46PB	100
A55CB	A55CBP	2" Chrome trim ring	20
BK5557GB	BK5557GBP	Cam-on mounting bracket	50
RETAIL			
MCL55AK	Yellow kit with A54GB & A46PB, clam		12
MCL55RK	Red kit with A54GB & A46PB, clam		12

FMVSS	P2
MATERIALS	Polycarbonate lens and housing
VOLT/AMP	12.8VDC - 0.06A
WT/DIMS	MCL55: .066 lbs. / 2" x 2" x 1" MCL55FRB: .078 lbs. / 2.875" x 2.875" x 1"
WARRANTY	Lifetime LED Warranty



MCL55AB



MCL55RB



MCL55ACB
MCL55RCB
UCL55CB

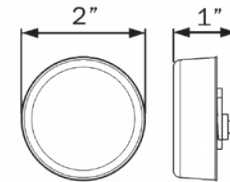

HOLE CUT-OUT: 2.313"



MCL55FRB

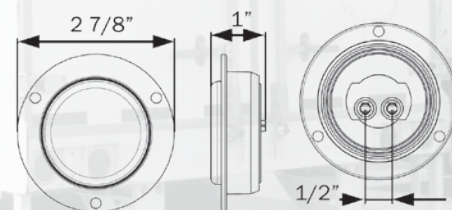

HOLE CUT-OUT: 2.313"

LED SEALED MARKER/
CLEARANCE LIGHTS



MCL505 SERIES 2" Round Sealed LED ABS Lights

- Sonically sealed, waterproof
- Accept standard two-pin PL-10 plugs
- Available in grommet and flange mount models
- MCL505GABSB includes A54GB grommet



MCL505ABS

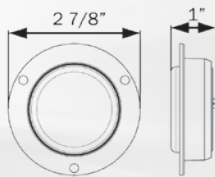

HOLE CUT-OUT: 2.313"



MCL505GABS

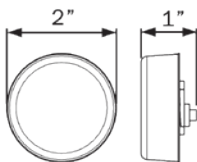

HOLE CUT-OUT: 2.313"

BULK P/N	POLYPACK P/N	DESCRIPTION	QTY
YELLOW - 3 DIODES			
MCL505ABS	MCL505ABSBP	Flange mount	50
MCL505GABS	MCL505GABSBP	Grommet mount kit, with A54GB grommet	20
ACCESSORIES			
A46PB	A46PBP	Straight PL-10 plug, 6" lead	100
A86PB	A86PBP	Straight PL-10 plug, 18" lead	100

FMVSS	P2
MATERIALS	Polycarbonate lens and housing
VOLT/AMP	12.8VDC - .06A
WT/DIMS	MCL505ABS: .078 lbs. / 2.875" x 2.875" x 1" MCL505GABS: .066 lbs. / 2" x 2" x 1"
WARRANTY	Lifetime LED Warranty

MCL56 SERIES

FLEET Count™ 2" Round Sealed LED Marker/Clearance Lights

- Sonically sealed, waterproof
- Accepts standard two-pin PL-10 plug
- Multiple mounting options available

BULK P/N	POLYPACK P/N	DESCRIPTION	QTY
YELLOW - 1 DIODE			
MCL56AB	MCL56ABP	Grommet mount, PL-10 connection	20
MCL56AFB	MCL56AFBP	Flange mount, PL-10 connection	20
MCL56AFMB	MCL56AFMBP	Flange mount, weathertight connection	20
RED - 1 DIODE			
MCL56RB	MCL56RBP	Grommet mount, PL-10 connection	20
MCL56RMB	MCL56RMBP	Grommet mount, weathertight connection	20
MCL56RFB	MCL56RFBP	Flange mount, PL-10 connection	20
MCL56RFMB	MCL56RFMBP	Flange mount, weathertight connection	20
ACCESSORIES			
A46PB	A46PBP	Straight PL-10 plug, 6" lead	100
A86PB	A86PBP	Straight PL-10 plug, 18" lead	100
A54GB	A54GBP	2" Flush mount grommet	100
A54GK	A54GKP	2" Kit: A54GB and A46PB	100
A55CB	A55CBP	2" Chrome trim ring	20
BK5557GB	BK5557GBP	Cam-on mounting bracket	50
RETAIL			
MCL56AK		Yellow kit with A54GB & A46PB, clam	12
MCL56AK6		Yellow kit with A54GB & A46PB, clam	6
MCL56AS		Yellow light only, clam	12
MCL56RK		Red kit with A54GB & A46PB, clam	12
MCL56RK6		Red kit with A54GB & A46PB, clam	6
MCL56RS		Red light only, clam	12

FMVSS	P2
MATERIALS	Polycarbonate lens and housing
VOLT/AMP	12.8VDC - 0.045A
WT/DIMS	Grommet mount: .066 lbs. / 2" x 2" x 1" Flange mount: .071 lbs. / 2.938" x 2.938" x .938"
WARRANTY	Lifetime LED Warranty



FLEET COUNT



MCL56AB



MCL56AFMB



MCL56AFB



MCL56RB



MCL56RFMB



MCL56RFB

LED SEALED MARKER/
CLEARANCE LIGHTS



MCL52AHXB 2" Round Sealed LED Marker/Clearance Light with Reflex Lens and Flange

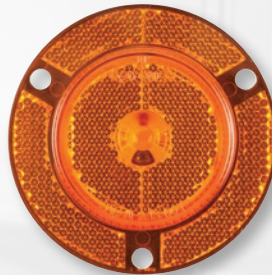

MCL52AHXB

- Recess flange mount
- Sonically sealed, waterproof
- Hard wired, includes separate ground wire
- Built-in reflex eliminates the need for a separate reflector

BULK P/N	POLYPACK P/N	DESCRIPTION	QTY
YELLOW - 7 DIODES			
MCL52AHXB	MCL52AHXBP	Reflex flange	50

FMVSS	A P2
MATERIALS	Polycarbonate lens and housing
VOLT/AMP	12.8VDC - 0.63A
WT/DIMS	.088 lbs. / 3.063" x 3.063" x .813"
WARRANTY	Lifetime LED Warranty

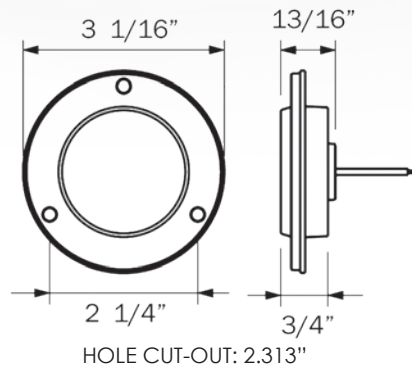

MCL50 SERIES

Miro-Flex™ 2" Round Sealed LED Marker/Clearance Lights

- Sonically sealed, waterproof
- Accepts standard two-pin PL-10 plug
- Multiple mounting options available

BULK P/N	POLYPACK P/N	DESCRIPTION	QTY
YELLOW - 9 DIODES			
MCL50AB	MCL50ABP	Light only	20
RED - 9 DIODES			
MCL50RB	MCL50RBP	Light only	20
ACCESSORIES			
A46PB	A46PBP	Straight PL-10 plug, 6" lead	100
A86PB	A86PBP	Straight PL-10 plug, 18" lead	100
A54GB	A54GBP	2" Flush mount grommet	100
A54GK	A54GKP	2" Kit: A54GB and A46PB	100
A55CB	A55CBP	2" Chrome trim ring	20
BK5557GB	BK5557GBP	Cam-on mounting bracket	50

FMVSS	P2
MATERIALS	Polycarbonate lens and housing
VOLT/AMP	12.8VDC - 0.047A
WT/DIMS	.088 lbs. / 2" x 2" x 1.188"
WARRANTY	Lifetime LED Warranty

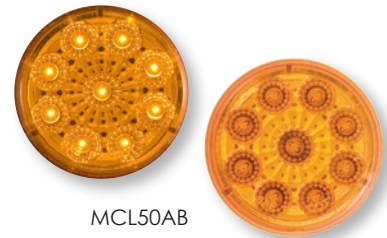

MCL50AB

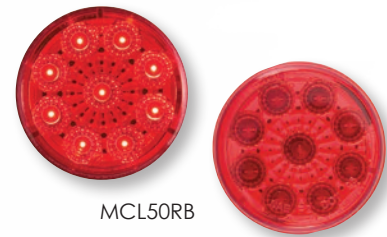

MCL50RB

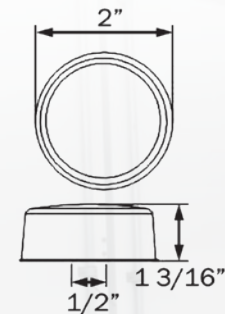

HOLE CUT-OUT: 2.313"

LED SEALED MARKER/
CLEARANCE LIGHTS



MCL52/54 SERIES

2" Round Sealed LED Marker/Clearance Lights



MCL54AB



MCL54RB

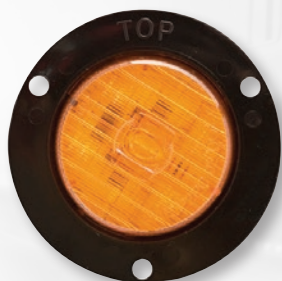

MCL52AB

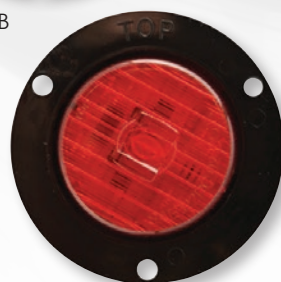

MCL52RB



detail of weathertight
connection on
MCL52AMB/RMB;
pigtail included

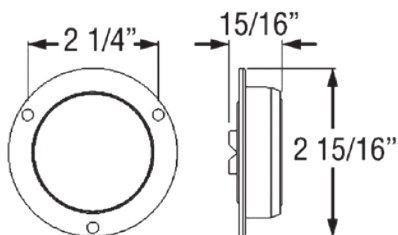

MCL52

HOLE CUT-OUT: 2.313"

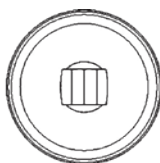

MCL54

HOLE CUT-OUT: 2.313"

- Sonically sealed, waterproof
- Available with standard PL-10 or optional weathertight connection
- PC rated: functions as both clearance and side marker light when properly mounted on a 45 degree angle
- Available in flange mount and grommet mount models

BULK P/N	POLYPACK P/N	DESCRIPTION	QTY
YELLOW - 5 DIODES			
MCL52AB	MCL52ABP	Flange mount, PL-10 connection	20
MCL52AMB	MCL52AMB	Flange mount, weathertight connection; pigtail included	20
MCL54AB	MCL54ABP	Grommet mount, PL-10 connection	20
RED - 5 DIODES			
MCL52RB	MCL52RBP	Flange mount, PL-10 connection	20
MCL52RMB	MCL52RMB	Flange mount, weathertight connection; pigtail included	20
MCL54RB	MCL54RBP	Grommet mount, PL-10 connection	20
ACCESSORIES			
A46PB	A46PBP	Straight PL-10 plug, 6" lead	100
A86PB	A86PBP	Straight PL-10 plug, 18" lead	100
AL42PB	AL42PBP	Weathertight pigtail	100
A54GB	A54GBP	2" Flush mount grommet	100
A54GK	A54GKP	2" Kit: A54GB and A46PB	100
A55CB	A55CBP	2" Chrome trim ring	20
BK5557GB	BK5557GBP	Cam-on mounting bracket	50
A52GB	A52GBP	Gasket for flange mount, black	100

FMVSS	P2 PC
MATERIALS	Polycarbonate lens and housing
VOLT/AMP	12.8VDC - 0.063A
WT/DIMS	Flange mount: .088 lbs. / 2.938" x 2.938" x 0.938" Grommet mount: .066 lbs. / 2.063" x 2.063" x 0.875"
WARRANTY	Lifetime LED Warranty

MCL157 SERIES

GloLight® 2.5" Round Sealed LED Marker/Clearance Lights

PATENTED TECHNOLOGY

- Sonically sealed, waterproof
- Accepts standard two-pin PL-10 plug

BULK P/N	POLYPACK P/N	DESCRIPTION	QTY
YELLOW - 9 DIODES			
MCL157AB	MCL157ABP	Light only	20
RED - 9 DIODES			
MCL157RB	MCL157RBP	Light only	20
ACCESSORIES			
A46PB	A46PBP	Straight PL-10 plug, 6" lead	100
A86PB	A86PBP	Straight PL-10 plug, 18" lead	100
A55GB	A55GBP	Flush mount grommet (open back)	50
A56GB	A56GBP	Recess mount grommet (closed back)	100
A57GB	A57GBP	Recess mount grommet (open back)	50
A55GK	A55GKP	Kit: A55GB and A46PB	100
A57GK	A57GKP	Kit: A57GB and A46PB	100
A57CB	A57CBP	Chrome trim ring	20
BK5557GB	BK5557GBP	Cam-on mounting bracket	50

FMVSS	P2
MATERIALS	Polycarbonate lens and housing
VOLT/AMP	12.8VDC - 0.099A
WT/DIMS	.132 lbs. / 2.5" x 2.5" x 1.125"
WARRANTY	Lifetime LED Warranty

GloLight®



MCL157AB



MCL157RB

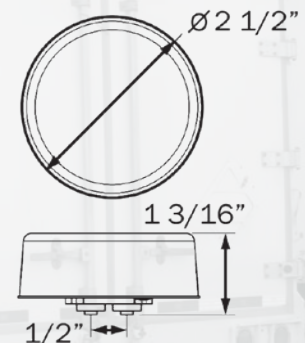

HOLE CUT-OUT: 2.75"

LED SEALED MARKER/
CLEARANCE LIGHTS



MCL57AB



MCL57RB



MCL57ACB/RCB

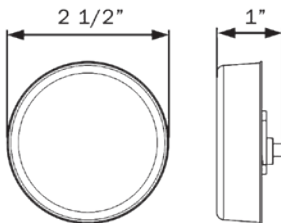

HOLE CUT-OUT: 2.75"

MCL57 SERIES 2.5" Round Sealed LED Marker/Clearance Lights

- Sonically sealed, waterproof
- Accepts standard two-pin PL-10 plug
- Available in 12V and 24V models

BULK P/N	POLYPACK P/N	DESCRIPTION	QTY
YELLOW - 3 DIODES			
MCL57AB	MCL57ABP	Light only, 12V	20
MCL57A24B	MCL57A24BP	Light only, 24V	20
MCL57ACB	MCL57ACBP	Clear lens light only, 12V	20
RED - 3 DIODES			
MCL57RB	MCL57RBP	Light only, 12V	20
MCL57RKB	MCL57RKBP	Kit with grommet and plug	20
MCL57R1224B	MCL57R1224BP	Light only, 12-24V	20
MCL57RCB	MCL57RCBP	Clear lens light only, 12V	20
ACCESSORIES			
A46PB	A46PBP	Straight PL-10 plug, 6" lead	100
A86PB	A86PBP	Straight PL-10 plug, 18" lead	100
A55GB	A55GBP	Flush mount grommet (open back)	50
A56GB	A56GBP	Recess mount grommet (closed back)	100
A57GB	A57GBP	Recess mount grommet (open back)	50
A55GK	A55GKP	Kit: A55GB and A46PB	100
A57GK	A57GKP	Kit: A57GB and A46PB	100
A57CB	A57CBP	Chrome trim ring	20
BK5557GB	BK5557GBP	Cam-on mounting bracket	50
RETAIL			
MCL57AK		Yellow kit with A55GB & A46PB, clam	12
MCL57RK		Red kit with A55GB & A46PB, clam	12

FMVSS	P2
MATERIALS	Polycarbonate lens and housing
VOLT/AMP	12.8VDC - 0.06A
WT/DIMS	.132 lbs. / 2.5" x 2.5" x 1"
WARRANTY	Lifetime LED Warranty

MCL527 SERIES

FLEET Count™ 2.5" Round Sealed LED Marker/Clearance Lights

- Sonically sealed, waterproof
- Accepts standard two-pin PL-10 plug
- Multiple mounting options available

BULK P/N	POLYPACK P/N	DESCRIPTION	QTY
YELLOW - 2 DIODES			
MCL527AB	MCL527ABP	Light only	20
MCL527AMB	MCL527AMB	Light only, weathertight connection	20
MCL527AFB	MCL527AFBP	Flange mount	20
RED - 2 DIODES			
MCL527RB	MCL527RBP	Light only	20
MCL527RMB	MCL527RMBP	Light only, weathertight connection	20
MCL527RFB	MCL527RFBP	Flange mount	20
ACCESSORIES			
A46PB	A46PBP	Straight PL-10 plug, 6" lead	100
A86PB	A86PBP	Straight PL-10 plug, 18" lead	100
A55GB	A55GBP	Flush mount grommet (open back)	50
A56GB	A56GBP	Recess mount grommet (closed back)	100
A57GB	A57GBP	Recess mount grommet (open back)	50
A55GK	A55GKP	Kit: A55GB and A46PB	100
A57GK	A57GKP	Kit: A57GB and A46PB	100
A57CB	A57CBP	Chrome trim ring	20
BK5557GB	BK5557GBP	Cam-on mounting bracket	50
RETAIL			
MCL527AK		Yellow kit with A57GB & A46PB, clam	12
MCL527AK6		Yellow kit with A57GB & A46PB, clam	6
MCL527AS		Yellow light only, clam	12
MCL527RK		Red kit with A57GB & A46PB, clam	12
MCL527RK6		Red kit with A57GB & A46PB, clam	6
MCL527RS		Red light only, clam	12

FMVSS	P2
MATERIALS	Polycarbonate lens and housing
VOLT/AMP	12.8VDC - 0.034A
WT/DIMS	Grommet Mount: .088 lbs. / 2.5" x 2.5" x 1.063" Flange Mount: .088lbs. / 3.438" x 3.438" x .938"
WARRANTY	Lifetime LED Warranty



MCL527AB



MCL527AFB



MCL527RB



MCL527RFB

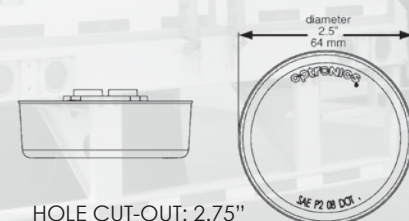
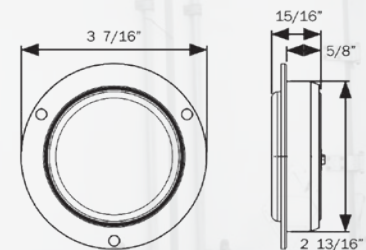

LED SEALED MARKER/
CLEARANCE LIGHTS



MCL58 SERIES 2.5" Round Sealed LED Marker/Clearance Lights



MCL58AB



MCL58ACB



MCL58RB



MCL58AMFB



MCL58RMFB

- Sonically sealed, waterproof
- Available with standard PL-10 or optional weathertight connection
- Multiple mounting options available
- PC rated: functions as both clearance and side marker light when properly mounted on a 45 degree angle

BULK P/N	POLYPACK P/N	DESCRIPTION	QTY
YELLOW - 7 DIODES			
MCL58AB	MCL58ABP	Light only, PL-10	20
MCL58ACB	MCL58ACBP	Clear lens, yellow diodes, light only, PL-10	20
MCL58APMB	MCL58APMBP	Light only, weathertight connection	20
MCL58AMFB	MCL58AMFBP	Flange mount, weathertight connection	50
RED - 7 DIODES			
MCL58RB	MCL58RBP	Light only	20
MCL58RPMB	MCL58RPMBP	Light only, weathertight connection	20
MCL58RMFB	MCL58RMFBP	Flange mount, weathertight connection	50
ACCESSORIES			
A46PB	A46PBP	Straight PL-10 plug, 6" lead	100
A86PB	A86PBP	Straight PL-10 plug, 18" lead	100
AL42PB	AL42PBP	Weathertight pigtail	100
AL42PG	AL42PGP	Weathertight pigtail, .180 bullets	100
A55GB	A55GBP	Flush mount grommet (open back)	50
A56GB	A56GBP	Recess mount grommet (closed back)	100
A57GB	A57GBP	Recess mount grommet (open back)	50
A55GK	A55GKP	Kit: A55GB and A46PB	100
A57GK	A57GKP	Kit: A57GB and A46PB	100
A57CB	A57CBP	Chrome trim ring	20
BK5557GB	BK5557GBP	Cam-on mounting bracket	50

FMVSS	P2 PC
MATERIALS	Polycarbonate lens and housing
VOLT/AMP	12.8VDC - 0.057A
WT/DIMS	Grommet Mount: .132 lbs. / 2.5" x 2.5" x 0.938" Flange Mount: .112lbs. / 3.42" x 3.42" x 1.30"
WARRANTY	Lifetime LED Warranty

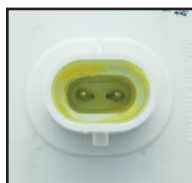

weathertight connection:
MCL58APMB/RPMB

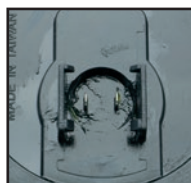

weathertight connection:
MCL58AMFB/RMFB

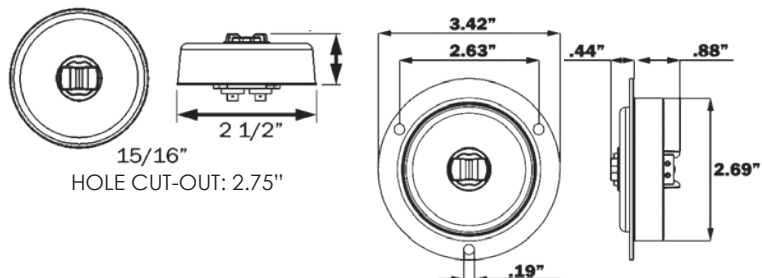

MCL59 SERIES

2.5" Round Sealed LED Marker/ Clearance Lights with Reflex

- Sonically sealed, waterproof
- Accepts standard two-pin PL-10 plug
- Multiple mounting options available
- Built-in reflex eliminates the need for a separate reflector

BULK P/N	POLYPACK P/N	DESCRIPTION	QTY
YELLOW - 8 DIODES			
MCL59AB	MCL59ABP	Light only	20
MCL59A1224B	MCL59A1224B	Light only, 12/24V	20
RED - 8 DIODES			
MCL59RB	MCL59RBP	Light only	20
MCL59R1224B	MCL59R1224B	Light only, 12/24V	20
ACCESSORIES			
A46PB	A46PBP	Straight PL-10 plug, 6" lead	100
A86PB	A86PBP	Straight PL-10 plug, 18" lead	100
A55GB	A55GBP	Flush mount grommet (open back)	50
A56GB	A56GBP	Recess mount grommet (closed back)	100
A57GB	A57GBP	Recess mount grommet (open back)	50
A55GK	A55GKP	Kit: A55GB and A46PB	100
A57GK	A57GKP	Kit: A57GB and A46PB	100
A57CB	A57CBP	Chrome trim ring	20
BK5557GB	BK5557GBP	Cam-on mounting bracket	50

FMVSS	A P2
MATERIALS	Polycarbonate lens and housing
VOLT/AMP	12.8VDC - 0.047A
WT/DIMS	.088 lbs. / 2.5" x 2.5" x 1.063"
WARRANTY	Lifetime LED Warranty



MCL59AB

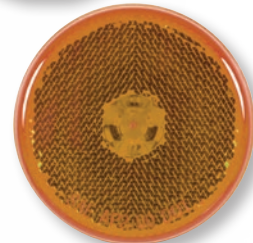

MCL59RB

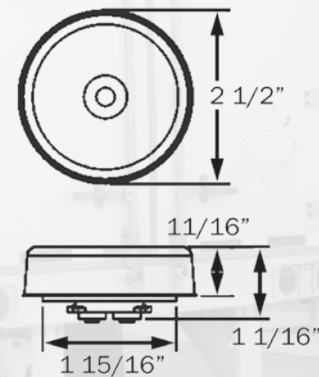

HOLE CUT-OUT: 2.75"

LED SEALED MARKER/
CLEARANCE LIGHTS



MCL002 SERIES

2.5" Recess Flange Mount LED Marker/ Clearance Lights with Locking Clip

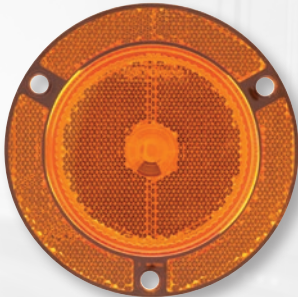
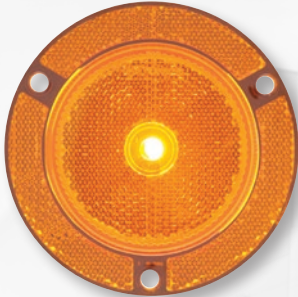

MCL002AXB

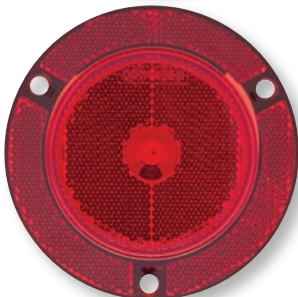
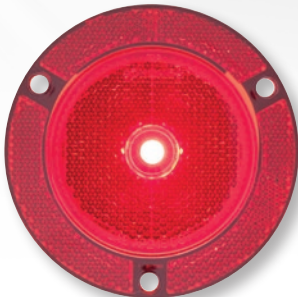

MCL002RXB

- Sonically sealed, waterproof
- Recess flange mount design fits 2.75" diameter hole cut-out
- Locking clip for PL-10 style plugs secures connection against road vibration
- Built-in reflex eliminates the need for a separate reflector
- Available in bulk and polypack packaging

BULK P/N	POLYPACK P/N	DESCRIPTION	QTY
YELLOW - 1 DIODE			
MCL002AXB	MCL002AXBP	Reflex flange, locking clip	50
RED - 1 DIODE			
MCL002RXB	MCL002RXBP	Reflex flange, locking clip	50

FMVSS	A P2
MATERIALS	Polycarbonate lens and housing
VOLT/AMP	12.8VDC - 0.45A
WT/DIMS	.112 lbs / 3.52" x 3.52" x 1.56"
WARRANTY	Lifetime LED Warranty

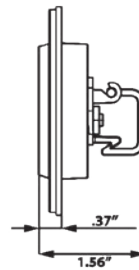
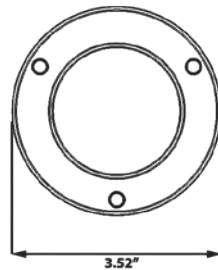

AL91 SERIES Mini Thinline Sealed LED Marker/Clearance Lights



- Sonically sealed, waterproof
- Standard models accept standard 1- or 2-wire plugs
- Hard wired design available in 1- and 2-wire models
- Single wire design grounds through mounting hardware
- Two-wire design includes both lead and ground wire for mounting to all surfaces
- PC rated light functions as both clearance and side marker light when properly mounted on a 45 degree angle

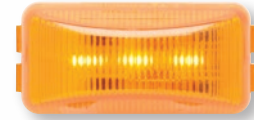

AL91AB



AL91RB

BULK P/N	POLYPACK P/N	DESCRIPTION	QTY
YELLOW - 3 DIODES			
AL91AB	AL91ABP	PC rated	50
AL91CAB	AL91CABP	PC rated, clear lens	50
AL91A1224B	AL91A1224BP	PC rated, 12-24V	50
MCL91AB	MCL91ABP	Kit: AL91AB, A91CB & A91LW	50
AL82AB	AL82ABP	PC rated, hard wired, 2-wire	50
MCL96AB	MCL96ABP	P2 rated kit, hard wired, 1-wire, A91BB base	50
RED - 3 DIODES			
AL91RB	AL91RBP	PC rated	50
MCL91RB	MCL91RBP	Kit: AL91RB, A91CB & A91LW	50
AL82RB	AL82RBP	PC rated, hard wired, 2-wire	50
MCL96RB	MCL96RBP	P2 rated kit, hard wired, 1-wire, A91BB base	50
ACCESSORIES			
A46PB	A46PBP	2-wire PL-10 plug, 6" lead	100
A86PB	A86PBP	2-wire PL-10 plug, 18" lead	100
A90CB	A90CBP	Chrome snap-on cover	50
A91LW	A91LWP	1-wire plug, 12" lead	100
A91BB	A91BBP	Black base, self grounding	100
A91BOB	A91BOBP	Black base, open back	100
A91CB	A91CBP	Chrome base, self grounding	100
A91OB	A91OBP	Chrome base, open back	100
A91GB	A91GBP	Grommet	100
RETAIL			
MCL91AK		Yellow P2 kit with A91CB & A91LW, clam	12
MCL90AS		Yellow P2 light only, clam	12
MCL91RK		Red P2 kit with A91CB & A91LW, clam	12
MCL90RS		Red P2 light only, clam	12

FMVSS PC (unless noted)

MATERIALS Polycarbonate lens and housing

VOLT/AMP 12.8VDC - 0.051A

WT/DIMS .088 lbs.
2.5" x 1.25" x 1"

WARRANTY Lifetime LED Warranty

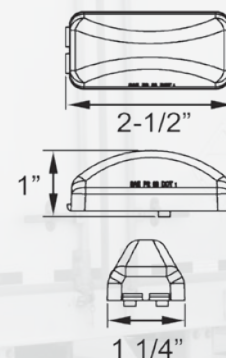

LED SEALED MARKER/
CLEARANCE LIGHTS

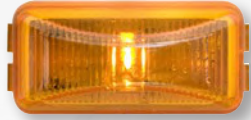

AL90AB



AL90RB

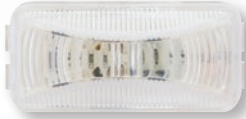
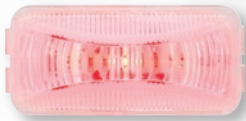

AL90RCB

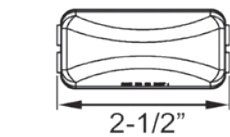

AL90 SERIES

FLEET Count™ Mini Thinline Sealed LED Marker/Clearance Light

- Sonically sealed, waterproof
- Accept standard 1- or 2-wire plugs
- Single wire design grounds through mounting hardware
- Two-wire design includes both lead and ground wire for mounting to all surfaces

BULK P/N	POLYPACK P/N	DESCRIPTION	QTY
YELLOW - 1 DIODE			
AL90AB	AL90ABP	Light only	50
RED - 1 DIODE			
AL90RB	AL90RBP	Light only	50
AL90RCB	AL90RCBP	Clear lens, red, light only	??
ACCESSORIES			
A46PB	A46PBP	2-wire PL-10 plug, 6" lead	100
A86PB	A86PBP	2-wire PL-10 plug, 18" lead	100
A90CB	A90CBP	Chrome snap-on cover	50
A91LW	A91LWP	1-wire plug, 12" lead	100
A91BB	A91BBP	Black base, self grounding	100
A91BOB	A91BOBP	Black base, open back	100
A91CB	A91CBP	Chrome base, self grounding	100
A91OB	A91OBP	Chrome base, open back	100
A91GB	A91GBP	Grommet	100
RETAIL			
AL90AK		Yellow kit with A91BB & A91LW, clam	12
AL90AS		Yellow light only, clam	12
AL90RK		Red kit with A91BB & A91LW, clam	12
AL90RS		Red light only, clam	12

FMVSS	P2
MATERIALS	Polycarbonate lens and housing
VOLT/AMP	12.8VDC - 0.023A
WT/DIMS	.044 lbs. / 2.5" x 1.25" x 1"
WARRANTY	Lifetime LED Warranty

MCL165 SERIES GloLight® Thinline Sealed LED Marker/Clearance Lights

GloLight®

LED SEALED MARKER/
CLEARANCE LIGHTS

PATENTED TECHNOLOGY

- Sonically sealed, waterproof
- Accept standard 1- or 2-wire plugs
- Single wire design grounds through mounting hardware
- Two-wire design includes both lead and ground wire for mounting to all surfaces

BULK P/N	POLYPACK P/N	DESCRIPTION	QTY
YELLOW - 10 DIODES			
MCL165AB	MCL165ABP	Light only	20
RED - 10 DIODES			
MCL165RB	MCL165RBP	Light only	20
ACCESSORIES			
A65B	A65BP	Black bracket	50
A65P	A65PP	Single wire plug, .156 male bullet	50
A65PB	A65PBP	Kit: A65B black bracket & A65P plug	50
A66PB	A66PBP	Kit: Gray bracket & A65P plug	50
A67CB	A67CBP	Kit: Chrome bracket & A65P plug	50
A68PB	A68PBP	Kit: Black bracket & 2-wire plug	50
For more details on mounting and wiring accessories, see Accessories section at back of catalog.			

FMVSS	P2
MATERIALS	Polycarbonate lens and housing
VOLT/AMP	12.8VDC - 0.09A
WT/DIMS	.066 lbs. / 3.875" x 1.25" x 1"
WARRANTY	Lifetime LED Warranty

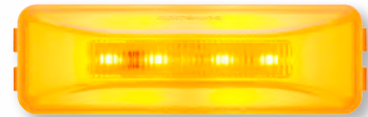

MCL165AB

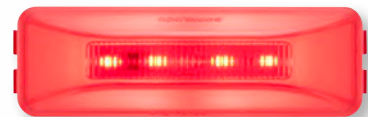

MCL165RB

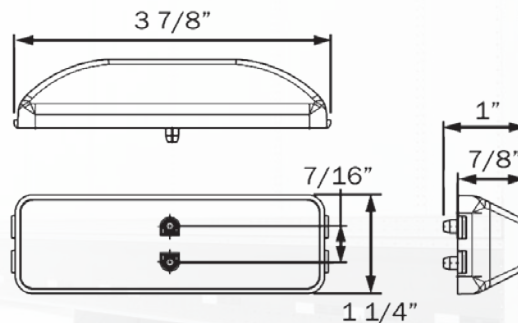

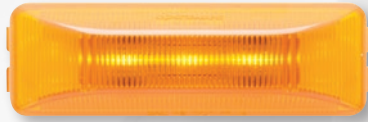

MCL65AB

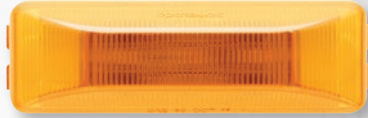

MCL65RB

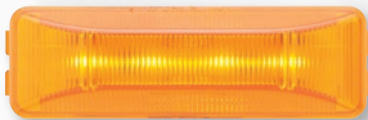

MCL75AB



MCL75RB



MCL77AB



MCL77RB

MCL65 SERIES Thinline Sealed LED Marker/Clearance Lights

- Sonically sealed, waterproof
- Accept standard 1- or 2-wire plugs
- Single wire design grounds through mounting hardware
- Two-wire design includes both lead and ground wire for mounting to all surfaces

BULK P/N	POLYPACK P/N	DESCRIPTION	QTY
YELLOW			
MCL65AB	MCL65ABP	12V, 3 diodes	20
MCL65A24B	MCL65A24BP	24V, 3 diodes	20
MCL65CAB	MCL65CABP	12V, 3 diodes, clear lens	20
MCL65AKB	MCL65AKBP	12V, 3 diodes, kit with A67CB1, A68P	20
MCL67AB	MCL67ABP	12V, 3 diodes, kit with A65PB	20
MCL75AB	MCL75ABP	12V, 4 diodes	20
MCL77AB	MCL77ABP	12V, 4 diodes, kit with A65PB	20
RED			
MCL65RB	MCL65RBP	12V, 3 diodes	20
MCL65R24B	MCL65R24BP	24V, 3 diodes	20
MCL65CRB	MCL65CRBP	12V, 3 diodes, clear lens	20
MCL65RKB	MCL65RKBP	12V, 3 diodes, kit with A67CB1, A68P	20
MCL67RB	MCL67RBP	12V, 3 diodes, kit with A65PB	20
MCL75RB	MCL75RBP	12V, 4 diodes	20
MCL77RB	MCL77RBP	12V, 4 diodes, kit with A65PB	20
ACCESSORIES			
A65B	A65BP	Black bracket	50
A65P	A65PP	Single wire plug, .156 male bullet	50
A68P	A68PP	Two wire plug, 6" lead	50
A65PB	A65PBP	Kit: A65B black bracket & A65P plug	50
A66PB	A66PBP	Kit: Gray bracket & A65P plug	50
A67CB	A67CBP	Kit: Chrome bracket & A65P plug	50
A68PB	A68PBP	Kit: Black bracket & 2-wire plug	50

For more details on mounting and wiring accessories, see Accessories section at back of catalog.

FMVSS	P2
MATERIALS	Polycarbonate lens and housing
VOLT/AMP	12.8VDC - 0.048A
WT/DIMS	.066 lbs. / 3.938" x 1.25" x 1.25"
WARRANTY	Lifetime LED Warranty

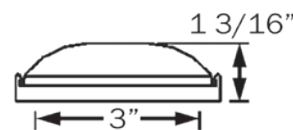
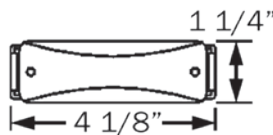

MCL61 SERIES

FLEET Count™ Thinline Sealed LED Marker/Clearance Lights

- Sonically sealed, waterproof
- Accept standard 1- or 2-wire plugs
- Single wire design grounds through mounting hardware
- Two-wire design includes both lead and ground wire for mounting to all surfaces

BULK P/N	POLYPACK P/N	DESCRIPTION	QTY
YELLOW - 2 DIODES			
MCL61AB	MCL61ABP	Light only	20
RED - 2 DIODES			
MCL61RB	MCL61RBP	Light only	20
ACCESSORIES			
A65B	A65BP	Black bracket	50
A65P	A65PP	Single wire plug, .156 male bullet	50
A68P	A68PP	Two wire plug, 6" lead	
A65PB	A65PBP	Kit: A65B black bracket & A65P plug	50
A66PB	A66PBP	Kit: Gray bracket & A65P plug	50
A67CB	A67CBP	Kit: Chrome bracket & A65P plug	50
A68PB	A68PBP	Kit: Black bracket & 2-wire plug	50

For more details on mounting and wiring accessories, see Accessories section at back of catalog.

RETAIL

MCL61AK		Yellow kit with A65PB, clam	12
MCL61RK		Red kit with A65PB, clam	12
MCL61AS		Yellow light only, clam	12
MCL61RS		Red light only, clam	12

FMVSS	P2
MATERIALS	Polycarbonate lens and housing
VOLT/AMP	12.8VDC - 0.051A
WT/DIMS	.066 lbs. / 4" x 1.25" x 1"
WARRANTY	Lifetime LED Warranty

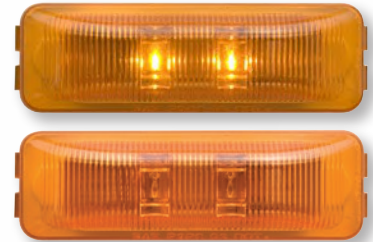

MCL61AB



MCL61RB

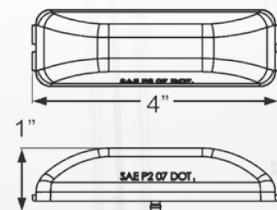

LED SEALED MARKER/
CLEARANCE LIGHTS



MCL63 SERIES

Miro-Flex™ Thinline Sealed LED Marker/Clearance Lights

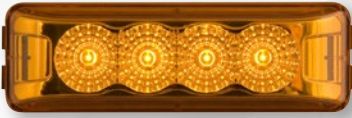

MCL63AB



MCL63CAB



MCL63CRB



MCL63RB

- Sonically sealed, waterproof
- Accept standard 1- or 2-wire plugs
- Single wire design grounds through mounting hardware
- Two-wire design includes both lead and ground wire for mounting to all surfaces

BULK P/N	POLYPACK P/N	DESCRIPTION	QTY
----------	--------------	-------------	-----

YELLOW - 4 DIODES

MCL63AB	MCL63ABP	Light only	20
---------	----------	------------	----

MCL63CAB	MCL63CABP	Light only, clear lens	20
----------	-----------	------------------------	----

RED - 4 DIODES

MCL63RB	MCL63RBP	Light only	20
---------	----------	------------	----

MCL63CRB	MCL63CRBP	Light only, clear lens	20
----------	-----------	------------------------	----

ACCESSORIES

A65B	A65BP	Black bracket	50
------	-------	---------------	----

A65P	A65PP	Single wire plug, .156 male bullet	50
------	-------	------------------------------------	----

A68P	A68PP	Two wire plug, 6" lead	
------	-------	------------------------	--

A65PB	A65PBP	Kit: A65B black bracket & A65P plug	50
-------	--------	-------------------------------------	----

A66PB	A66PBP	Kit: Gray bracket & A65P plug	50
-------	--------	-------------------------------	----

A67CB	A67CBP	Kit: Chrome bracket & A65P plug	50
-------	--------	---------------------------------	----

A68PB	A68PBP	Kit: Black bracket & 2-wire plug	50
-------	--------	----------------------------------	----

For more details on mounting and wiring accessories, see Accessories section at back of catalog.

FMVSS	P2
MATERIALS	Polycarbonate lens and housing
VOLT/AMP	12.8VDC - 0.051A
WT/DIMS	.066 lbs. / 4" x 1.25" x 1"
WARRANTY	Lifetime LED Warranty

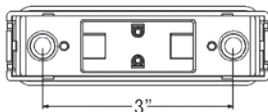
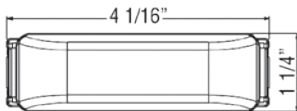

MCL61/65 SERIES

Thinline Sealed LED Fender Lights

- Sonically sealed, waterproof
- Accept standard 1- or 2-wire plugs
- Single wire design grounds through mounting hardware
- Two-wire design includes both lead and ground wire for mounting to all surfaces

BULK P/N	POLYPACK P/N	DESCRIPTION	QTY
DUAL RED/YELLOW - 10 DIODES			
MCL65ARB	MCL65ARBP	Light only	20
MCL65CARB	MCL65CARBP	Light only, clear lens	20
MCL67ARB	MCL67ARBP	Kit with A65PB bracket & plug	20
DUAL RED/YELLOW - 2 DIODES			
MCL61ARB	MCL61ARBP	Light only	20
MCL61AR26BK	MCL61AR26BKP	Kit with A67BB black base & 26" power wire with .150 male bullet	20
ACCESSORIES			
A67BB	A67BBP	Black fender bracket	50
A67GB	A67GBP	Gray fender bracket	50
A67CVB	A67CVBP	Curved fender bracket, gray	50
A65B	A65BP	Black bracket	50
A65P	A65PP	Single wire plug, .156 male bullet	50
A68P	A68PP	Two wire plug, 6" lead	50
A65PB	A65PBP	Kit: A65B black bracket & A65P plug	50
A66PB	A66PBP	Kit: Gray bracket & A65P plug	50
A67CB	A67CBP	Kit: Chrome bracket & A65P plug	50
A68PB	A68PBP	Kit: Black bracket & 2-wire plug	50

For more details on mounting and wiring accessories, see Accessories section at back of catalog.

FMVSS	P2
MATERIALS	Polycarbonate lens and housing
VOLT/AMP	12.8VDC - 0.048A
WT/DIMS	.066 lbs. / 3.875" x 1.25" x 0.875"
WARRANTY	Lifetime LED Warranty

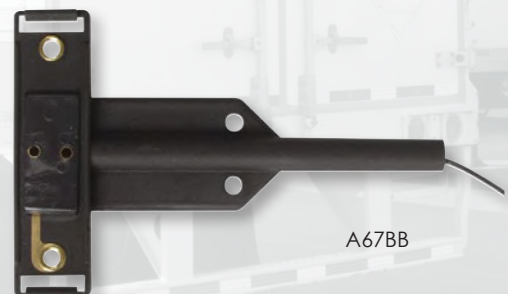
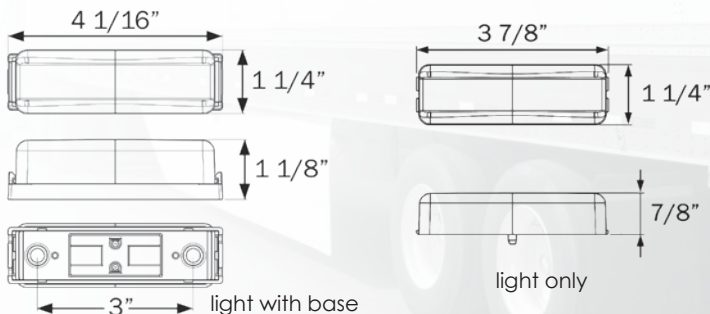

MCL65ARB

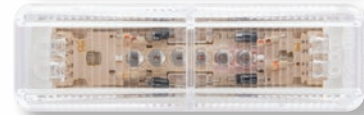
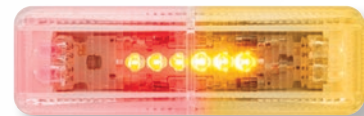

MCL65CARB



MCL61ARB



MCL99 SERIES Mini Sealed LED Horizontal-Vertical Marker/Clearance Lights

- Sealed, waterproof design
- Surface mount installation at either horizontal or vertical
- Single wire design grounds through mounting hardware
- Two-wire design includes both lead and ground wire for mounting to all surfaces

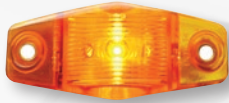

MCL99AB



MCL99RB



MCL99AC1B



MCL99RC1B

BULK P/N	POLYPACK P/N	DESCRIPTION	QTY
YELLOW - 1 DIODE			
MCL99AB	MCL99ABP	2-wire	20
MCL99AC1B	MCL99AC1BP	Clear lens, single wire, self-grounding	50
RED - 1 DIODE			
MCL99RB	MCL99RBP	2-wire	20
MCL99RC1B	MCL99RC1BP	Clear lens, single wire, self-grounding	50

FMVSS	P2
MATERIALS	Polycarbonate lens and housing
VOLT/AMP	12.8VDC - .06A
WT/DIMS	.088 lbs. / 2.5" x 1.125" x 0.625"
WARRANTY	Lifetime LED Warranty

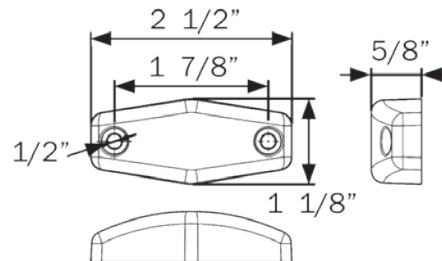

MCL13 SERIES

Mini Sealed LED Surface Mount Marker/Clearance Lights

- Sonically sealed, waterproof
- Single wire design grounds through mounting hardware
- Two-wire design includes both lead and ground wire for mounting to all surfaces

BULK P/N	POLYPACK P/N	DESCRIPTION	QTY
YELLOW - 2 DIODES			
MCL13A2B	MCL13A2BP	2-wire	20
MCL13A2MB	MCL13A2MBP	2-wire, .156 male bullets, 5.5-in. leads	20
MCL13APG	MCL13APGP	2-wire, .156 male bullets, 12-in. leads	20
MCL13A21PG	MCL13A21PGP	2-wire, .156 female plugs	20
MCL131A2B	MCL131A2BP	1-wire, self-grounding	20
MCL13CA2B	MCL13CA2BP	2-wire, clear lens	20
MCL13CA3B	MCL13CA3BP	2-wire, clear lens, no ring on ground	50
MCL131CA3B	MCL131CA3BP	1-wire, clear lens, self grounding	50
MCL131A210B	MCL131A210BP	1-wire, self grounding, fits #10 screws	20
MCL131AC210B	MCL131AC210BP	1-wire, clear lens, self grounding, fits #10 screws	20
RED - 2 DIODES			
MCL13R2B	MCL13R2BP	2-wire	20
MCL13R2MB	MCL13R2MBP	2-wire, .156 male bullets	20
MCL13R21PG	MCL13R21PGP	2-wire, .156 female plugs	20
MCL131R2B	MCL131R2BP	1-wire	20
MCL13CR2B	MCL131CR2BP	2-wire, clear lens	20
MCL131CR3B	MCL131CR3BP	1-wire, clear lens, self grounding	50
MCL131R210B	MCL131R210BP	1-wire, self grounding, fits #10 screws	20
MCL131RC210B	MCL131RC210BP	1-wire, clear lens, self grounding, fits #10 screws	20
ACCESSORIES			
A13B2B	A13B2BP	Black base/bezel	100
A13C2B	A13C2BP	Chrome base/bezel	100
A13NCC2B	A13NCCBP	Unfinished base/bezel	100
A13B210B	A13B210BP	Matte black base/bezel, fits #10 screws	100
A13C210B	A13C210BP	Chrome base/bezel, fits #10 screws	100
A13G2B	A13G2BP	Gasket	200
RETAIL			
MCL13ATRS		Yellow, 2-wire, chrome bezel	12
MCL13AS		Yellow 2-wire light only	12
MCL13RTRS		Red, 2-wire, chrome bezel	12
MCL13RS		Red 2-wire light only	12

FMVSS	P2 P3 (except UCL13)
MATERIALS	Polycarbonate lens and housing
VOLT/AMP	12.8VDC - 0.046A
WT/DIMS	.088 lbs. / 2.5" x 1.063" x 0.688"
WARRANTY	Lifetime LED Warranty



MCL13A2B



MCL13CA2B



MCL13CR2B



MCL13R2B

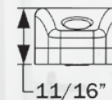
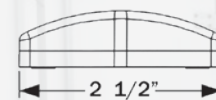



MCL14 SERIES Mini Sealed LED Horizontal-Vertical Marker/Clearance Lights



- Sonically sealed, waterproof
- Surface mount installation at either horizontal or vertical
- Single wire design grounds through mounting hardware
- Two-wire design includes both lead and ground wire for mounting to all surfaces
- Available in red, yellow, and clear lens



MCL14AB



MCL14RB



MCL14CABF



MCL14CRBF



MCL14 clear
lens, unlit

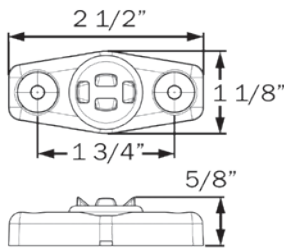

BULK P/N	POLYPACK P/N	DESCRIPTION	QTY
YELLOW - 3 DIODES			
MCL14AB	MCL14ABP	2-wire	20
MCL14ABF	MCL14ABFP	2-wire, female PL-10 plug	20
MCL14AGB	MCL14AGBP	1-wire, self grounding, 6-in. lead	20
MCL14A12GB	MCL14A12GBP	1-wire, self grounding, 12-in. lead	20
MCL14AGPB	MCL14AGPBP	1-wire, .180 male bullet	20
MCL14CABF	MCL14CABFP	Clear lens, 2-wire, .156 female barrels	20
MCL14CAGB	MCL14CAGBP	Clear lens, 1-wire, self grounding	20
RED - 3 DIODES			
MCL14RB	MCL14RBP	2-wire	20
MCL14R2B	MCL14R2BP	2-wire, .180 male bullets	20
MCL14RBF	MCL14RBF	2-wire, female plug	20
MCL14RGB	MCL14RGBP	1-wire, self grounding	20
MCL14RPG	MCL14RPGP	2-wire, .156 male bullets, 12-in. leads	20
MCL14CRGB	MCL14CRGBP	Clear lens, 1-wire, self grounding	20
MCL14CRBF	MCL14CRBFP	Clear lens, 2-wire, .156 female barrels	20
ACCESSORIES			
A13C2B	A13C2BP	Chrome base/bezel	100
A13B2B	A13B2BP	Black base/bezel	100
A13G2B	A13G2BP	Gasket	200

FMVSS	P2 PC
MATERIALS	Polycarbonate lens and housing
VOLT/AMP	12.8VDC - 0.06A
WT/DIMS	.088 lbs. / 2.5" x 1.125" x 0.625"
WARRANTY	Lifetime LED Warranty



A13C2B

MCL15 SERIES Surface Mount LED Marker/Clearance Lights

- Sonically sealed, waterproof
- Surface mount installation
- Hard wired, includes both lead and ground wire with molded .180 male bullets
- Chrome finish ABS trim ring included with kits

BULK P/N	POLYPACK P/N	DESCRIPTION	QTY
YELLOW - 2 DIODES			
MCL15APG	MCL15APGP	Light only, .180 male bullets	20
MCL15AKPG	MCL15AKPGP	Kit: MCL15APG, chrome trim ring	20
RED - 2 DIODES			
MCL15RPG	MCL15RPGP	Light only, .180 male bullets	20
MCL15RKPG	MCL15RKPGP	Kit: MCL15RPG, chrome trim ring	20
ACCESSORIES			
A15CB	A15CBP	Chrome base/bezel	100
A15GB	A15GBP	Gasket	50
A15CGB	A15CGBP	Chrome base/bezel and gasket	100

FMVSS	P2
MATERIALS	Polycarbonate lens and housing
VOLT/AMP	12.8VDC - 0.047A
WT/DIMS	Light: .088 lbs. / 2.625" x 1.375" x .563" Kit: .092 lbs. / 3.938" x 1.344" x .688"
WARRANTY	Lifetime LED Warranty



MCL15APG



MCL15AKPG



MCL15RPG



MCL15RKPG

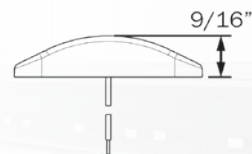
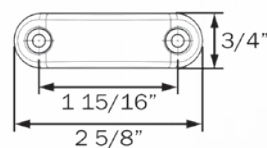

MCL15APG/RPG

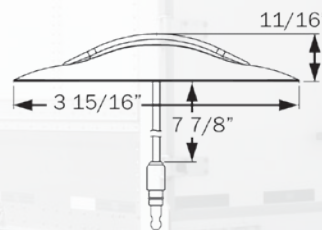
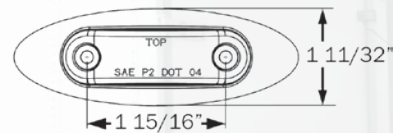

MCL15AKPG/RKPG



MCL299 SERIES

Sealed LED Marker/Clearance Light

- Sonically sealed, waterproof
- Adhesive mount
- Hard wired, includes separate ground wire



MCL299AB



MCL299RB

BULK P/N	POLYPACK P/N	DESCRIPTION	QTY
YELLOW - 1 DIODE			
MCL299AB	MCL299ABP	Light only	50
MCL290APG	MCL290APGP	Light, .180 male bullets	50
RED - 1 DIODE			
MCL299RB	MCL299RBP	Light only	50
MCL290RPG	MCL290RPGP	Light, .180 male bullets	50

FMVSS	PC
MATERIALS	Polycarbonate lens and housing
VOLT/AMP	Yellow: 12.8VDC - 0.12A Red: 12.8V - 0.065A
WT/DIMS	.03 lbs. / 1.50" x .625" x .75"
WARRANTY	Lifetime LED Warranty

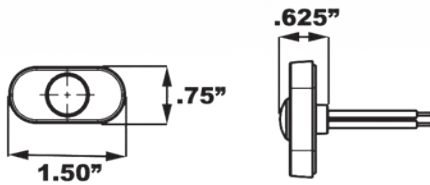

MCL17/19 SERIES

Miro-Flex™ Surface Mount Sealed LED Marker/Clearance Lights

- Sonically sealed, waterproof
- Two-wire design includes both lead and ground wire for mounting to all surfaces
- Snap-on chrome trim ring included
- Available in 3-LED 4" model and 4-LED 6" model

BULK P/N	POLYPACK P/N	DESCRIPTION	QTY
YELLOW			
MCL17AB	MCL17ABP	3-LED	20
MCL17ABB	MCL17ABBP	3-LED, black trim ring	20
MCL17CAB	MCL17CABP	3-LED, clear lens	20
MCL19AB	MCL19ABP	4-LED	20
MCL19CAB	MCL19CABP	4-LED, clear lens	20
RED			
MCL17RB	MCL17RBP	3-LED	20
MCL17RBB	MCL17RBBP	3-LED, black trim ring	20
MCL17CRB	MCL17CRBP	3-LED, clear lens	20
MCL19RB	MCL19RBP	4-LED	20
MCL19CRB	MCL19CRBP	4-LED, clear lens	20
ACCESSORIES			
A17GB	A17GBP	Black gasket for 3-LED models	100
A19CB	A19CBP	Chrome bezel	50

FMVSS	P2
MATERIALS	Polycarbonate lens and housing
VOLT/AMP	MCL17: 12.8VDC - 0.047A MCL19: 12.8VDC - 0.051A
WT/DIMS	MCL17: .088 lbs. / 4.188" x 1.375" x .75" MCL19: .132 lbs. / 5.75" x 1.563" x .75"
WARRANTY	Lifetime LED Warranty

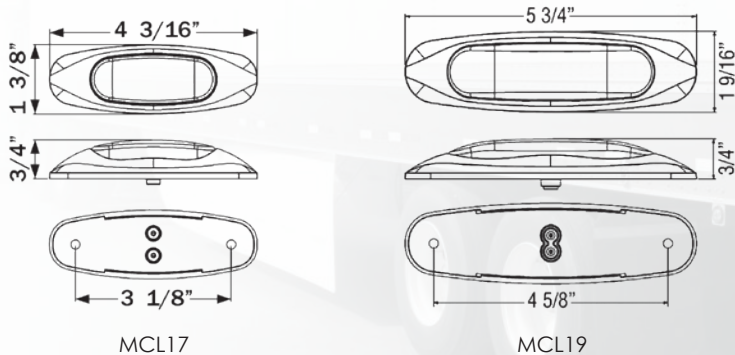

MCL17AB



MCL17CAB/CRB



MCL17RB



MCL19AB



MCL19CAB/CRB



MCL19RB



A17GB



MCL0030 SERIES

Surface Mount LED Marker/Clearance Lights with Reflex

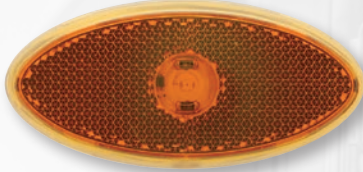
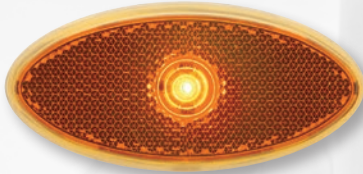

MCL0030ABB

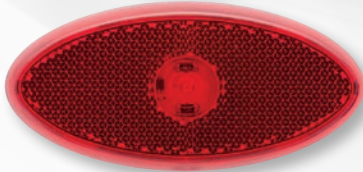

MCL0030RBB

- Ultrathin design - only 3/8" thick
- Surface mount on 2.7" centers
- Snap-on lens with reflex eliminates the need for a separate reflector
- Hard wired

BULK P/N	POLYPACK P/N	DESCRIPTION	QTY
YELLOW - 1 DIODE			
MCL0030ABB	MCL0030ABBP	Hard wired	20
RED - 1 DIODE			
MCL0030RBB	MCL0030RBBP	Hard wired	20
ACCESSORIES			
A0028CRB	A0028CRBP	Chrome snap-on bezel	50

FMVSS	A P2
MATERIALS	Polycarbonate lens and housing
VOLT/AMP	12.8VDC - 0.073A
WT/DIMS	.08 lbs. / 3.77" x 1.79" x .36"
WARRANTY	Lifetime LED Warranty

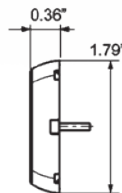
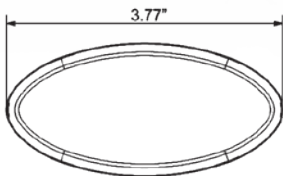

MCL0039 SERIES

2.5" Round LED Marker/Clearance Lights with Reflex

- Surface mount black base
- Snap-on lens with reflex eliminates the need for a separate reflector
- Hard wired with power and ground wires

BULK P/N	POLYPACK P/N	DESCRIPTION	QTY
YELLOW - 1 DIODE			
MCL0039ABB	MCL0039ABBP	Hard wired	20
RED - 1 DIODE			
MCL0039RBB	MCL0039RBBP	Hard wired	20

FMVSS	A P2
MATERIALS	Polycarbonate lens and housing
VOLT/AMP	12.8VDC - 0.073A
WT/DIMS	.08 lbs. / 2.5" x 2.5" x .8"
WARRANTY	Lifetime LED Warranty

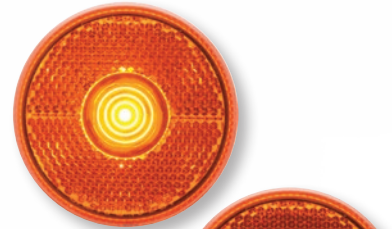

MCL0039ABB

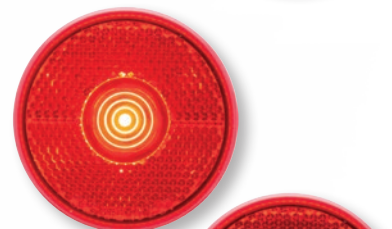

MCL0039RBB

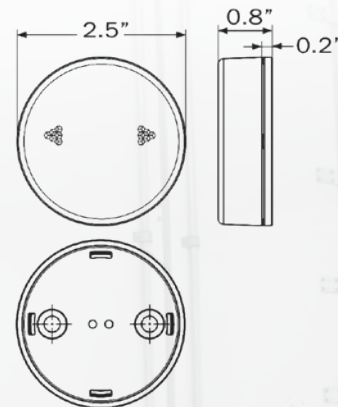

SURFACE MOUNT LED MARKER/CLEARANCE LIGHTS



MCL31 SERIES

Surface Mount LED Marker/ Clearance Lights with Reflex

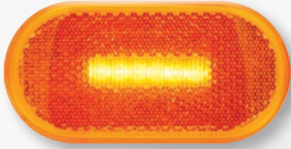

MCL31AB

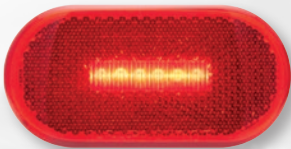
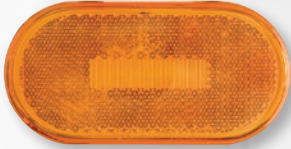

MCL31RB



- Snap-on, replaceable lens
- Lens with reflex eliminates need for separate reflector
- Two-wire design includes both lead and ground wire for mounting to all surfaces

BULK P/N	POLYPACK P/N	DESCRIPTION	QTY
YELLOW - 6 DIODES			
MCL31AB	MCL31ABP	Light only, white base	20
RED - 6 DIODES			
MCL31RB	MCL31RBP	Light only, white base	20
MCL31RPG	MCL31RPGP	Light only, white base, .180 male bullets	20

FMVSS	A P2
MATERIALS	Acrylic lens, ABS housing
VOLT/AMP	12.8VDC - 0.040A
WT/DIMS	.132 lbs. / 4" x 2.063" x 1"
WARRANTY	Lifetime LED Warranty

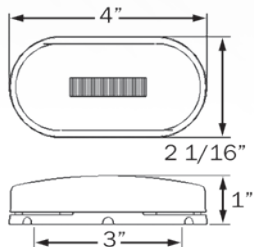

MCL32 SERIES

Surface Mount LED Marker/ Clearance Lights with Reflex

- Snap-on, replaceable lens
- Lens with reflex eliminates need for separate reflector
- Two-wire design includes both lead and ground wire for mounting to all surfaces

BULK P/N	POLYPACK P/N	DESCRIPTION	QTY
YELLOW - 3 DIODES			
MCL32AB	MCL32ABP	Light only, white base	100
MCL32ATB	MCL32ATBP	Supplemental turn, white base	50
MCL32ABB	MCL32ABBP	Light only, black base	100
RED - 3 DIODES			
MCL32RB	MCL32RBP	Light only, white base	100
MCL32RBB	MCL32RBBP	Light only, black base	100
ACCESSORIES			
A32AB	A32ABP	Yellow replacement lens	10
A32RB	A32RBP	Red replacement lens	50
RETAIL			
MCL32ABS		Yellow light with black base	12
MCL32RBS		Red light with black base	12
MCL32AS		Yellow light with white base	12
MCL32RS		Red light with white base	12

FMVSS	A P2
MATERIALS	Acrylic lens, ABS housing
VOLT/AMP	12.8VDC - 0.6A
WT/DIMS	.132 lbs. / 4" x 2" x 1"
WARRANTY	Lifetime LED Warranty

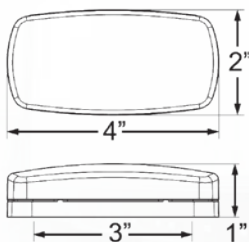

MCL32AB

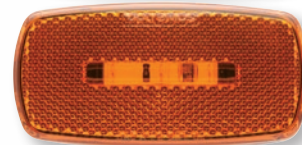
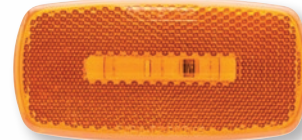

MCL32ABB



MCL32RB



MCL32RBB



MCL0032ABB

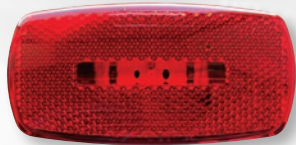

MCL0032RBB

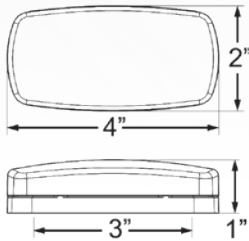

MCL0032 SERIES

Surface Mount LED Marker/ Clearance Lights with Reflex

- Snap-on, replaceable lens
- Surface mount base, mounts on 3" centers
- Lens with reflex eliminates need for separate reflector
- Two-wire design includes both lead and ground wire for mounting to all surfaces

BULK P/N	POLYPACK P/N	DESCRIPTION	QTY
YELLOW - 1 DIODE			
MCL0032ABB	MCL0032ABBP	Light only, black base	100
RED - 1 DIODE			
MCL0032RBB	MCL0032RBBP	Light only, black base	100
ACCESSORIES			
A32AB	A32ABP	Yellow replacement lens	50
A32RB	A32RBP	Red replacement lens	50
RETAIL			
MCL0032ABS		Yellow light with black base, clam	12
MCL0032RBS		Red light with black base, clam	12

FMVSS	A P2
MATERIALS	Acrylic lens, ABS housing
VOLT/AMP	12.8VDC - 0.6A
WT/DIMS	.132 lbs. / 4" x 2" x 1"
WARRANTY	Lifetime LED Warranty

MCL35AEB

Surface Mount LED Marker/ Clearance Light with Reflex

- Surface ear mount black base, mounts on 3.25" centers
- Lens with reflex eliminates need for separate reflector
- Single wire design grounds through mounting hardware

BULK P/N	POLYPACK P/N	DESCRIPTION	QTY
YELLOW - 3 DIODES			
MCL35AEB	MCL35AEBP	Light only	50

FMVSS	A P2
MATERIALS	Acrylic lens, ABS housing
VOLT/AMP	12.8VDC - 0.07A
WT/DIMS	.132 lb / 3.75" x 2.03" x .96"
WARRANTY	Lifetime LED Warranty

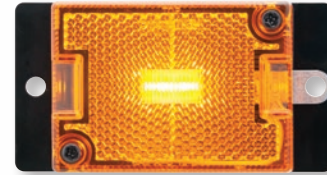

MCL35AEB

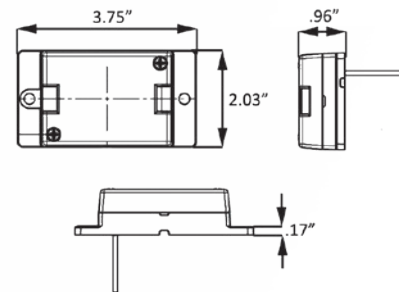

MCL35A32G

Surface Mount LED Marker/ Clearance Light with Reflex

- Surface mount black base, mounts on 3-5/16" centers
- Lens with reflex eliminates need for separate reflector
- Self grounding; 32" power wire with .180 male bullet

BULK P/N	POLYPACK P/N	DESCRIPTION	QTY
YELLOW - 6 DIODES			
MCL35A32G	MCL35A32GP	Light, 32" lead with .180 male bullet	50

FMVSS	A P2
MATERIALS	Acrylic lens, ABS housing
VOLT/AMP	12.8VDC - 0.165A
WT/DIMS	.110 lbs. / 3.875" x 2.375" x 0.938"
WARRANTY	Lifetime LED Warranty

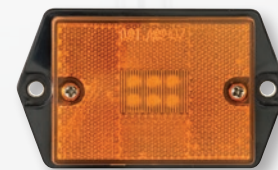

MCL35A32G

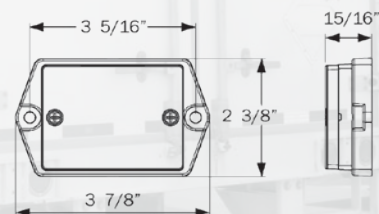



MCL36 SERIES Stud Mount LED Marker/ Clearance Light with Reflex

- Stud mount black base; two-wire design
- Lens with reflex eliminates need for separate reflector

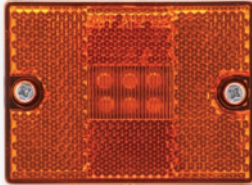
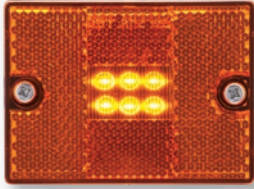

MCL36AB

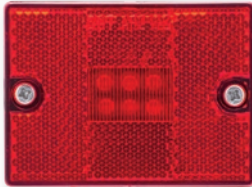
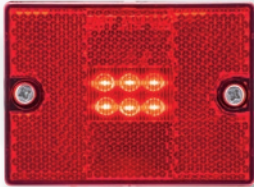

MCL36RB

BULK P/N	POLYPACK P/N	DESCRIPTION	QTY
YELLOW - 6 DIODES			
MCL36AB	MCL36ABP	Hard wired	20
RED - 6 DIODES			
MCL36RB	MCL36RBP	Hard wired	20
RETAIL			
MCL36AS		Yellow light with hardware, clam	12
MCL36AS6		Yellow light with hardware, clam	6

FMVSS	A P2
MATERIALS	Acrylic lens, ABS housing
VOLT/AMP	12.8VDC - 0.054A
WT/DIMS	.110 lbs. / 2.875" x 2.125" x .938"
WARRANTY	Lifetime LED Warranty

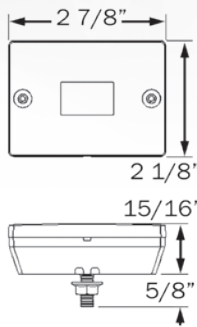

MCL40/44 SERIES

Surface Mount LED Marker/ Clearance Lights with Reflex

- Select from 2-LED and 6-LED models in yellow and red
- Snap-on, replaceable lens
- Surface mount white base, mounts on 3" centers
- Lens with reflex eliminates need for separate reflector
- Single wire and two-wire designs available

BULK P/N	POLYPACK P/N	DESCRIPTION	QTY
YELLOW			
MCL40AB	MCL40ABP	2-LED, 2-wire, power and ground	20
MCL40APB	MCL40APBP	2-LED, 2-wire .180 male bullets	20
MCL44AB	MCL44ABP	6-LED, 2-wire, power and ground	20
MCL44AB1	MCL44AB1P	6-LED, 1-wire, self grounding	20
RED			
MCL40RB	MCL40RBP	2-LED, 2-wire, power and ground	20
MCL44RB	MCL44RBP	6-LED, 2-wire, power and ground	20
MCL44RB1	MCL44RB1P	6-LED, 1-wire, self grounding	20
ACCESSORIES			
A44AB	A44ABP	Yellow replacement lens	10
A44RB	A44RBP	Red replacement lens	10
RETAIL			
MCL40AS		Yellow 2-LED, 2-wire, clam	12
MCL40RS		Red 2-LED, 2-wire, clam	12

FMVSS	P2 A
MATERIALS	Acrylic lens, ABS housing
VOLT/AMP	12.8VDC - 2-LED 0.040A; 6-LED .054A
WT/DIMS	.088 lbs. / 4" x 1.5" x 0.938"
WARRANTY	Lifetime LED Warranty

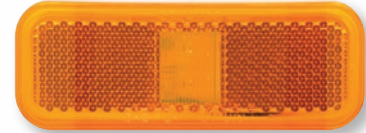
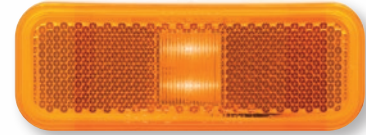

MCL40AB

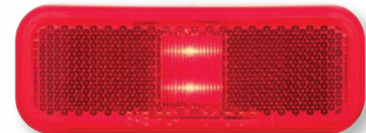

MCL40RB

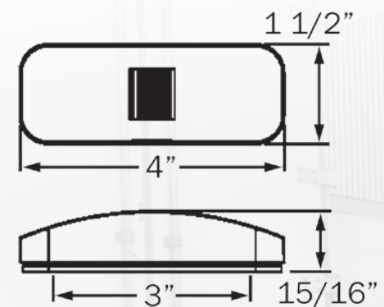

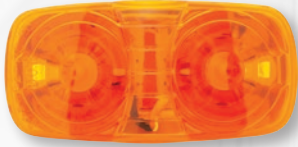

MCL45/46AB



MCL45/46RB

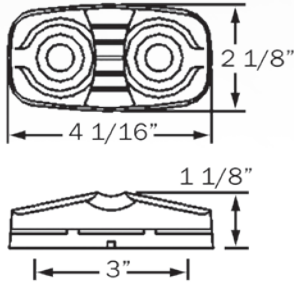

MCL45/46 SERIES LED Double Bullseye Style Marker/Clearance Lights



- Snap-on, replaceable lens
- Surface mount white base, mounts on 3" centers
- Single wire and two-wire designs available

BULK P/N	POLYPACK P/N	DESCRIPTION	QTY
YELLOW - 10 DIODES			
MCL45AB	MCL45ABP	1-wire, self grounding	20
MCL46AB	MCL46ABP	2-wire, power and ground	20
RED - 10 DIODES			
MCL45RB	MCL45RBP	1-wire, self grounding	20
MCL46RB	MCL46RBP	2-wire, power and ground	20
ACCESSORIES			
AL46AB	AL46ABP	Yellow replacement lens	50
AL46RB	AL46RBP	Red replacement lens	50
RETAIL			
MCL45AS		Yellow 1-wire, clam	12
MCL45RS		Red 1-wire, clam	12

FMVSS	P2 PC
MATERIALS	Acrylic lens, ABS housing
VOLT/AMP	12.8VDC - 0.087A
WT/DIMS	.088 lbs. / 4.063" x 2.125" x 1.125"
WARRANTY	Lifetime LED Warranty

MCL49 SERIES Surface Mount Sealed LED Marker/Clearance Light



- Sonically sealed, waterproof
- Surface mount, mounts on 3" centers
- Includes both lead and ground

BULK P/N	POLYPACK P/N	DESCRIPTION	QTY
YELLOW - 14 DIODES			
MCL49AB	MCL49ABP	Light only	20
RED - 14 DIODES			
MCL49RB	MCL49RBP	Light only	20

FMVSS	P2 PC
MATERIALS	Polycarbonate lens and housing
VOLT/AMP	12.8VDC - 0.87A
WT/DIMS	.132 lbs. / 3.875" x 2" x 1"
WARRANTY	Lifetime LED Warranty

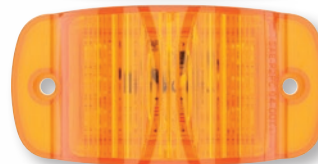
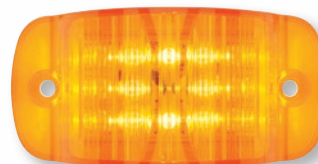

MCL49AB



MCL49RB

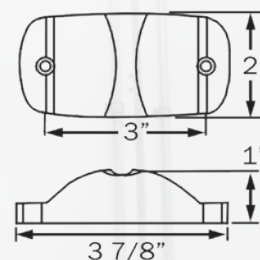



MCL48AB



MCL48CAB

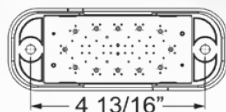
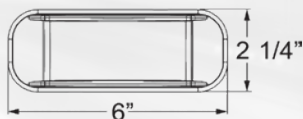

MCL73AB

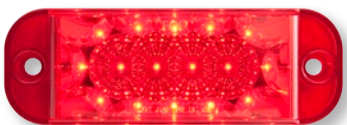

MCL73RB

MCL48 SERIES

LED Intermediate Side Marker Light with Supplemental Mid-Ship Turn

- Sonically sealed, waterproof
- Surface mount, mounts on 4-13/16" centers
- Includes both lead and ground wires

BULK P/N	POLYPACK P/N	DESCRIPTION	QTY
YELLOW - 16 DIODES			
MCL48AB	MCL48ABP	Light	20
MCL48CAB	MCL48CABP	Light, clear lens	20
MCL48AKB	MCL48AKBP	Kit: Light and A48CB	20
ACCESSORIES			
A48CB	A48CBP	Chrome bezel	50

FMVSS	P2
MATERIALS	Polycarbonate lens and housing
VOLT/AMP	12.8VDC - Side marker .074A; Turn signal .248A
WT/DIMS	.221 lbs. / 6" x 2.25" x 1.375"
WARRANTY	Lifetime LED Warranty

MCL73 SERIES

LED Surface Mount Marker/Clearance Lights



- Sonically sealed, waterproof
- Surface mount, mounts on 4-13/16" centers
- Includes both lead and ground wires

BULK P/N	POLYPACK P/N	DESCRIPTION	QTY
YELLOW - 16 DIODES			
MCL73AB	MCL73ABP	Light	20
RED - 16 DIODES			
MCL73RB	MCL73RBP	Light	20
ACCESSORIES			
A48CB	A48CBP	Chrome bezel	50

FMVSS	P2 PC
MATERIALS	Polycarbonate lens and housing
VOLT/AMP	12.8VDC - .248A
WT/DIMS	.221 lbs. / 6" x 2.25" x 1.375"
WARRANTY	Lifetime LED Warranty

MCL66 SERIES

Sealed LED Surface Mount Marker/Clearance Lights

- Sonically sealed, waterproof
- Surface mount, mounts on 3" centers
- Includes both lead and ground wire

BULK P/N	POLYPACK P/N	DESCRIPTION	QTY
YELLOW - 6 DIODES			
MCL66AB	MCL66ABP	12V	20
MCL66APG	MCL66APGP	12V, .180 male bullets	20
MCL66A24B	MCL66A24BP	12-24V	20
MCL66CAB	MCL66CABP	12V, clear lens	20
RED - 6 DIODES			
MCL66RB	MCL66RBP	12V	20
MCL66RPG	MCL66RPGP	12V, .180 male bullets	20
MCL66R24B	MCL66R24BP	12-24V	20
MCL66CRB	MCL66CRBP	12V, clear lens	20
ACCESSORIES			
A66GB	A66GBP	Gasket, black	100
BK66DB	BK66DBP	Heavy duty armored base, die cast metal	50
BK66D1B	BK66D1BP	Heavy duty armored base, metal, black finish, open design	50
RETAIL			
MCL66AS		Yellow 6-LED, 12V, clam	12
MCL66RS		Red 6-LED, 12V, clam	12

FMVSS	P2
MATERIALS	Polycarbonate lens and housing
VOLT/AMP	12.8VDC - 0.057A
WT/DIMS	.088 lbs. / 4" x .875" x 1.188"
WARRANTY	Lifetime LED Warranty



MCL66AB

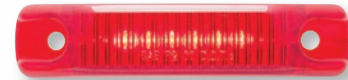

MCL66RB



MCL66CAB

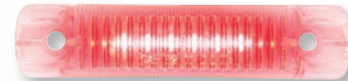

MCL66CRB

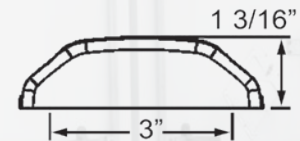



MCL71RB

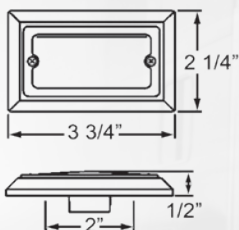

MCL71 SERIES

Low Profile LED Marker/ Clearance Light

- Chrome plated housing, replaceable lens
- Includes both lead and ground wire

BULK P/N	POLYPACK P/N	DESCRIPTION	QTY
RED - 2 DIODES			
MCL71RB	MCL71RBP	Flush mount marker light	20
FMVSS	P2		
MATERIALS	Acrylic lens, chrome plated ABS bezel		
VOLT/AMP	12.8VDC - 0.054A		
WT/DIMS	.088 lbs. / 3.75" x 2.25" x 1/2"		
WARRANTY	Lifetime LED Warranty		

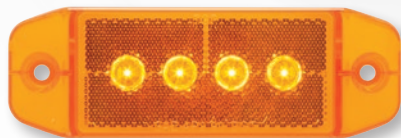

MCL76AB

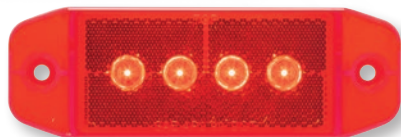

MCL76RB

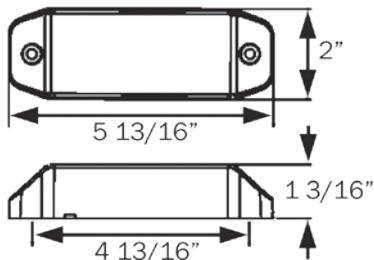

MCL76 SERIES

Sealed LED Surface Mount Marker/ Clearance Lights with Reflex

- Sonically sealed, waterproof
- Surface mount, mounts on 4-13/16" centers
- Lens with reflex eliminates need for a separate reflector
- Includes weathertight pigtail with both lead and ground wire

BULK P/N	POLYPACK P/N	DESCRIPTION	QTY
YELLOW - 4 DIODES			
MCL76AB	MCL76ABP	Light with reflex	20
RED - 4 DIODES			
MCL76RB	MCL76RBP	Light with reflex	20
RETAIL			
MCL76AS		Yellow light, clam	6
MCL76RS		Red light, clam	6
FMVSS	A P2		
MATERIALS	Polycarbonate lens and housing		
VOLT/AMP	12.8VDC - 0.063A		
WT/DIMS	.132 lbs. / 5.813" x 2" x 1.188"		
WARRANTY	Lifetime LED Warranty		

MCL82 SERIES

Flush Mount LED Marker/Clearance Lights with Reflex

- Sonically sealed, waterproof
- Low profile, flush mount design
- Lens with reflex eliminates need for a separate reflector
- Hard wired, includes lead and ground wire

BULK P/N	POLYPACK P/N	DESCRIPTION	QTY
YELLOW - 3 DIODES			
MCL82AB	MCL82ABP	Light only, 2-wire	50
RED - 3 DIODES			
MCL82RB	MCL82RBP	Light only, 2-wire	50

FMVSS	A P2
MATERIALS	Polycarbonate lens and housing
VOLT/AMP	12.8VDC - 0.05A
WT/DIMS	.09 lbs / 4.50" x 1.63" x .75"
WARRANTY	Lifetime LED Warranty

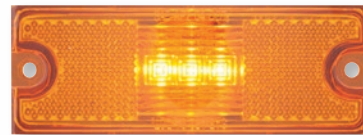

MCL82AB

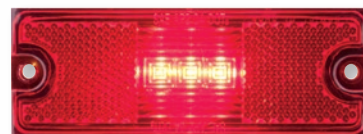
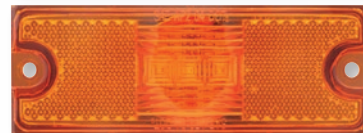

MCL82RB

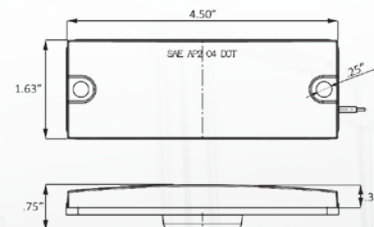

SURFACE MOUNT LED MARKER/CLEARANCE LIGHTS



MCL85AB

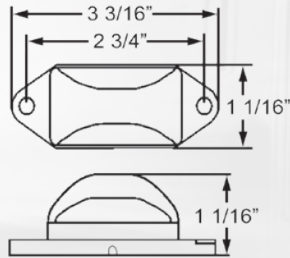

MCL85 SERIES

Sealed LED Surface Mount Marker/Clearance Lights

- Sonically sealed, waterproof
- Surface mount, mounts on 2-3/4" centers
- Single wire design grounds through mounting hardware

BULK P/N	POLYPACK P/N	DESCRIPTION	QTY
YELLOW - 3 DIODES			
MCL85AB	MCL85ABP	Surface mount light	50
RETAIL			
MCL85AS		Yellow light with hardware, clam	12
MCL85RS		Red light with hardware, clam	12
FMVSS	P2 P3		
MATERIALS	Polycarbonate lens and housing		
VOLT/AMP	12.8VDC - 0.066A		
WT/DIMS	.044 lbs. / 3.188" x 1.063" x 1.188"		
WARRANTY	Lifetime LED Warranty		



MCL81AB



MCL81RB

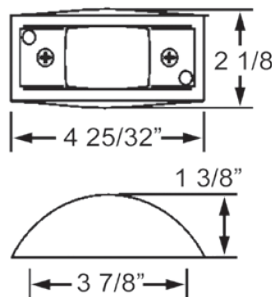

MCL81 SERIES

Chrome Plated LED Marker/Clearance Lights

- Chrome plated ABS housing
- Includes both lead and ground wire



BULK P/N	POLYPACK P/N	DESCRIPTION	QTY
YELLOW - 6 DIODES			
MCL81AB	MCL81ABP	Light with ABS housing	20
RED - 6 DIODES			
MCL81RB	MCL81RBP	Light with ABS housing	20
FMVSS	P2 PC		
MATERIALS	Acrylic lens, chrome plated ABS bezel		
VOLT/AMP	12.8VDC - 0.153A		
WT/DIMS	.265 lbs. / 4.781" x 2.125" x 1.375"		
WARRANTY	Lifetime LED Warranty		

MCL86 SERIES

Armored Die Cast LED Marker/Clearance Lights



- Die cast steel housing, mounting gasket
- Surface mount, mounts on 3-7/8" centers
- Two-wire design with power and ground wires

BULK P/N	POLYPACK P/N	DESCRIPTION	QTY
YELLOW - 6 DIODES			
MCL86AB	MCL86ABP	Light with steel housing	20
RED - 6 DIODES			
MCL86RB	MCL86RBP	Light with steel housing	20
FMVSS	P2 PC		
MATERIALS	Acrylic lens, steel housing		
VOLT/AMP	12.8VDC - 0.20A		
WT/DIMS	.463 lbs. / 4.5" x 2.25" x 1.5"		
WARRANTY	Lifetime LED Warranty		



MCL86AB



MCL86RB

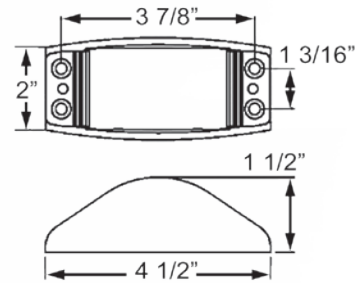

SURFACE MOUNT LED MARKER/CLEARANCE LIGHTS

MCL95 SERIES

Sealed Stud Mount LED Marker/Clearance Lights

- Sonically sealed, waterproof
- Single wire design grounds through mounting hardware

BULK P/N	POLYPACK P/N	DESCRIPTION	QTY
YELLOW - 3 DIODES			
MCL95AB	MCL95ABP	1-wire, 20" lead	50
MCL95ABF	MCL95ABFP	2-wire, 5mm female barrels	50
RED - 3 DIODES			
MCL95RB	MCL95RBP	1-wire, 20" lead	50
MCL95RBF	MCL95RBF	2-wire, 5mm female barrels	50
RETAIL			
MCL95AS		Yellow, single wire, clam	12
MCL95RS		Red, single wire, clam	12



FMVSS	P2 P3		
MATERIALS	Polycarbonate lens and housing, plated steel stud		
VOLT/AMP	12.8VDC - 0.051A		
WT/DIMS	.088 lbs. / 2.125" x 1.125" x 1.063"		
WARRANTY	Lifetime LED Warranty		



MCL95AB



MCL95RB

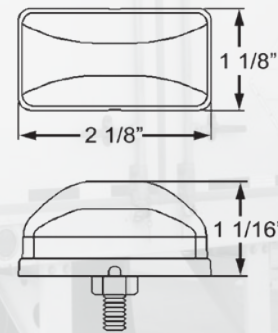



CBL22 SERIES Sealed LED Triangular Cab/Clearance Light



- Sonically sealed, waterproof
- Design includes lead and ground wire
- Mounting gasket included



CBL22AB



CBL22RB



BULK P/N	POLYPACK P/N	DESCRIPTION	QTY
YELLOW - 15 DIODES			
CBL22AB	CBL22ABP	Cab light	50
CBL22CAB	CBL22CABP	Cab light, clear lens	50
RED - 15 DIODES			
CBL22RB	CBL22RBP	Cab light	50
RETAIL			
CBL22AS		Yellow cab light, clam	12

FMVSS	P2 PC
MATERIALS	Polycarbonate lens and housing
VOLT/AMP	12.8VDC - 0.107A
WT/DIMS	.176 lbs. / 3.5" x 2.75" x 1.688"
WARRANTY	Lifetime LED Warranty

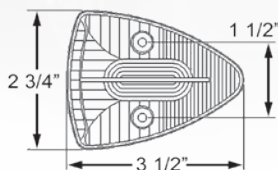

MCL180 SERIES LED Fender Light Assembly

- Reversible - one product can be used for either driver or passenger side of trailer
- Sonically sealed, waterproof
- P2 rated
- Hard wired, includes separate ground wire



SURFACE MOUNT LED
MARKER/CLEARANCE LIGHTS

BULK P/N	POLYPACK P/N	DESCRIPTION	QTY
FENDER LIGHT - 2 DIODES			
MCL180ARB	MCL180ARBP	Amber/red, reversible	50
RETAIL			
MCL180ARFK		Kit: (2) MCL180ARB, clam	2

FMVSS	P2
MATERIALS	Polycarbonate lens and housing
VOLT/AMP	12.8VDC - .033A
WT/DIMS	.05 lbs. / 8.50" x 1.688" x .813"
WARRANTY	Lifetime LED Warranty

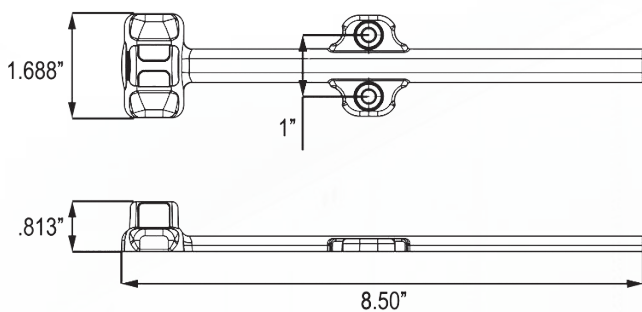



MCL181 SERIES LED Fender Light Assembly



MCL181ARCRB

- Reversible - one product can be used for both driver and passenger side of trailer
- Sonically sealed, waterproof
- Snap-on chrome-plated ABS trim ring
- Hard wired, includes separate ground wire

BULK P/N	POLYPACK P/N	DESCRIPTION	QTY
FENDER LIGHT - 2 DIODES			
MCL181ARCRB	MCL181ARCRBP	Amber/red, reversible, 2-wire, 5.5-in. leads	50
MCL181ARCRL12B	MCL181ARCRL12BP	Amber/red, reversible, 2-wire, 12-in. leads	50
MCL181ARCRGB	MCL181ARCRGBP	Amber/red, reversible, single wire self-grounding, 9-in. lead	50

FMVSS	P2
MATERIALS	Polycarbonate lens and housing
VOLT/AMP	12.8VDC - 0.04A
WT/DIMS	.04 lbs. / 1.70" x 1.21" x .82"
WARRANTY	Lifetime LED Warranty

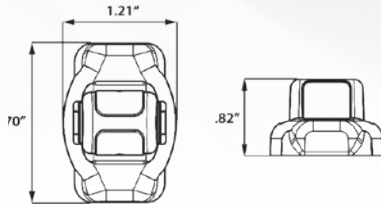

MCL10 SERIES

Sealed 3/4" LED Identification Lights for Over 80" Applications

- Three 3/4-inch lights with grommets and insulated wiring harness
- Sonically sealed, waterproof
- Design includes both lead and ground wire
- Available in bulk and polypack packaging



MCL10ACK3L12B



MCL10RCK3L12B

BULK P/N	POLYPACK P/N	DESCRIPTION	QTY
YELLOW ID LIGHTS - 3 DIODES			
MCL10ACK3L12B	MCL10ACK3L12BP	Clear lens (3) MCL10 lights, A12GB grommets, 29-in. molded harness	20
RED ID LIGHTS - 3 DIODES			
MCL10RCK3L12B	MCL10RCK3L12BP	Clear lens (3) MCL10 lights, A12GB grommets, 29-in. molded harness	20

FMVSS	P2
MATERIALS	Polycarbonate lens and housing
VOLT/AMP	12.8VDC - 0.022A
WT/DIMS	.25 lbs. / 0.75" x 0.75" x 0.95"
WARRANTY	Lifetime LED Warranty

LED IDENTIFICATION LIGHT BARS



MCL12/22/122 SERIES

Sealed 3/4" LED Identification Lights for Over 80" Applications



MCL12RK3B

- Sonically sealed, waterproof
- Design includes both lead and ground wire

BULK P/N	POLYPACK P/N	DESCRIPTION	QTY
RED ID LIGHTS - 3 DIODES			
MCL12RK3B	MCL12RK3BP	(3) red MCL12 lights, molded harness	20
MCL12RK3RMB	MCL12RK3RMBP	(3) red MCL12 lights, molded harness, weathertight plug	50
MCL22RK3B	MCL22RK3BP	(3) red MCL12 lights, supplemental turn function, .180 male bullets	20
MCL22RK4B	MCL22RK4BP	(3) red MCL12 lights, supplemental turn function, amp connector	20
MCL22RK5B	MCL22RK5BP	(3) red MCL12 lights, supplemental turn function, amp connector, 48-in. leads	20

FMVSS	P2
MATERIALS	Polycarbonate lens and housing
VOLT/AMP	12.8VDC - 0.022A
WT/DIMS	.25 lbs. / 0.75" x 0.75" x 0.95"
WARRANTY	Lifetime LED Warranty



MCL922 SERIES

Sealed 3/4" LED Identification Light Bar for Over 80" Applications

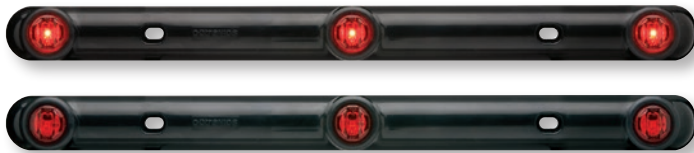

MCL922RB

- Three 3/4-inch lights installed in a corrosion proof ABS base
- Sonically sealed, waterproof
- Design includes both lead and ground wire

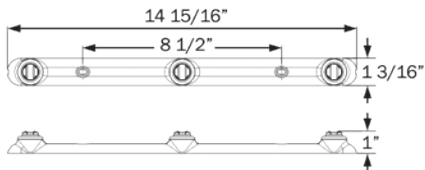

BULK P/N	POLYPACK P/N	DESCRIPTION	QTY
RED ID LIGHTS - 3 DIODES			
MCL922RB	MCL922RBP	ID light bar, molded black base	10

FMVSS	P2
MATERIALS	Polycarbonate lens and housing
VOLT/AMP	12.8VDC - 0.022A
WT/DIMS	MCL922RB: .441 lb. / 14.875" x 1.25" x 1"
WARRANTY	Lifetime LED Warranty

MCL98 SERIES

Sealed LED Identification Light Bar for Over 80" Applications



- Sonically sealed, waterproof
- Compact – 14.25" x 1.125"
- Design includes both lead and ground wire

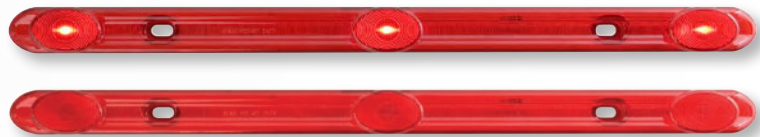

MCL98RB

BULK P/N	POLYPACK P/N	DESCRIPTION	QTY
RED ID LIGHT BAR - 3 DIODES			
MCL98RB	MCL98RBP	ID light bar, 6-in. leads	10
MCL98RBTCPG	MCL98RBTCPGP	ID light bar, .156 bullets, 48-in. leads	20
MCL98RL60B	MCL98RL60BP	ID light bar, 60-in. leads	10
MCL98RL601B	MCL98RL601BP	ID light bar, 60-in. power lead, 10-in. ground lead	10
RETAIL			
MCL98RK		Light bar, slipover blister	6

FMVSS	P2
MATERIALS	Polycarbonate lens and housing
VOLT/AMP	12.8VDC - 0.020A
WT/DIMS	.243 lb. / 14.25" x 1.125" x .875"
WARRANTY	Lifetime LED Warranty

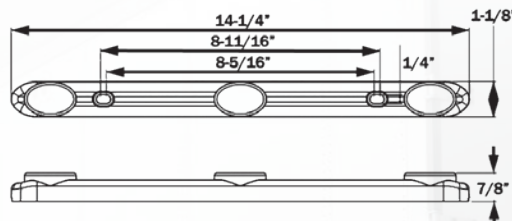

MCL98RK

LED IDENTIFICATION LIGHT BARS



MCL70RB



MCL70RCB

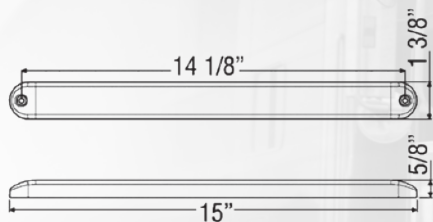

MCL70 SERIES

Sealed LED Identification Light Bars for Over 80" Applications

- Sonically sealed, waterproof
- Ultra thin – only 5/8" thick
- Design includes both lead and ground wire

BULK P/N	POLYPACK P/N	DESCRIPTION	QTY
RED ID LIGHT BAR - 3 DIODES			
MCL70RB	MCL70RBP	ID light bar	10
MCL70RBF2	MCL70RBF2P	ID light bar, .180 female barrels	10
MCL70RCB	MCL70RCBP	ID light bar, clear lens	10
MCL70RCGB	MCL70RCGBP	ID light bar, self grounding	10
ACCESSORIES			
A69CB	A69CBP	Chrome base/bezel	10
A69GB	A69GBP	Mounting gasket, black	10
RETAIL			
MCL70RS		Red, clam	6

FMVSS	P2
MATERIALS	Polycarbonate lens and housing
VOLT/AMP	12.8VDC - 0.038A
WT/DIMS	.441 lb. / 15" x 1.375" x .625"
WARRANTY	Lifetime LED Warranty



MCL78RB

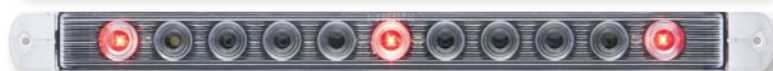

MCL88RCB

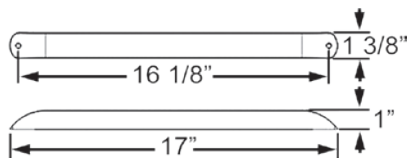

MCL78/88 SERIES

Sealed LED Identification Light Bars for Over 80" Applications

- Sonically sealed, waterproof
- Ultra thin – only 1" thick
- Design includes both lead and ground wire

BULK P/N	POLYPACK P/N	DESCRIPTION	QTY
RED ID LIGHT BAR - 3 DIODES			
MCL78RB	MCL78RBP	ID light bar	10
MCL88RCB	MCL88RCBP	ID light bar, clear lens	10
ACCESSORIES			
A79CB	A79CBP	Chrome base/bezel	10
FMVSS	P2		
MATERIALS	Polycarbonate lens and housing		
VOLT/AMP	12.8VDC - 0.022A		
WT/DIMS	.441 lb. / 17" x 1.375" x 1"		
WARRANTY	Lifetime LED Warranty		

MCL964 SERIES

Sealed LED Identification Light Bar for Over 80" Applications



- Sonically sealed, waterproof
- Low profile – only 0.79" thick
- Design includes both lead and ground wire



MCL964RB

BULK P/N	POLYPACK P/N	DESCRIPTION	QTY
RED ID LIGHT BAR - 3 DIODES			
MCL964RB	MCL964RBP	ID light bar	10
ACCESSORIES			
A64CRB	A64CRBP	Chrome base/bezel	50

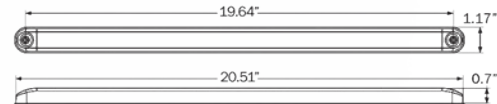

FMVSS	P2
MATERIALS	Polycarbonate lens and housing
VOLT/AMP	12.8VDC
WT/DIMS	0.441 / 20.56" x 1.09" x 0.79"
WARRANTY	Lifetime LED Warranty

LED IDENTIFICATION LIGHT BARS

MCL83 SERIES

FLEET Count™ Sealed LED Identification Light Bar for Over 80" Applications



- Sonically sealed, waterproof lights snap onto corrosion proof polycarbonate base
- Design includes both lead and ground wire



MCL83RB

BULK P/N	POLYPACK P/N	DESCRIPTION	QTY
RED ID LIGHT BAR - 3 DIODES			
MCL83RB	MCL83RBP	3-LED ID light bar	10
AL90RB	AL90RBP	1-LED replacement light	50
RETAIL			
MCL83RK		3-LED ID light bar, slipover blister	6

FMVSS	P2
MATERIALS	Polycarbonate lens and housing
VOLT/AMP	12.8VDC - .069A
WT/DIMS	.397 lb. / 15.938" x 1.469" x 1.625"
WARRANTY	Lifetime LED Warranty

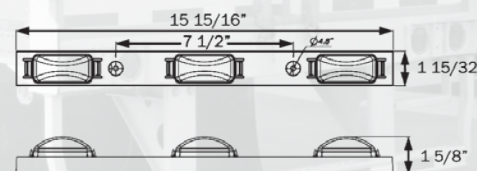



MCL93 SERIES

Sealed LED Identification Light Bar for Over 80" Applications



MCL93RB

- Sonically sealed, waterproof lights snap onto corrosion proof polycarbonate base
- Design includes both lead and ground wire

BULK P/N	POLYPACK P/N	DESCRIPTION	QTY
RED ID LIGHT BAR - 9 DIODES			
MCL93RB	MCL93RBP	9-LED ID light bar	10
MCL93RPG	MCL93RPGP	9-LED ID light bar, .180 male bullet on power, eyelet on ground	10
AL91RB	AL91RBP	3-LED replacement light	50
RETAIL			
MCL93RK		9-LED ID light bar, slipover blister	6

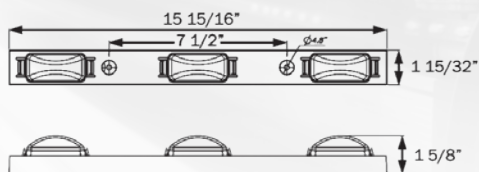

FMVSS	P2
MATERIALS	Polycarbonate lens and housing
VOLT/AMP	12.8VDC - 0.153A
WT/DIMS	.397 lb. / 15.938" x 1.469" x 1.625"
WARRANTY	Lifetime LED Warranty



MCL914R1PG

Sealed LED Identification Light Bar for Over 80" Applications



MCL914R1PG

- Sonically sealed, waterproof
- Hard wired, with .180 female barrels

BULK P/N	POLYPACK P/N	DESCRIPTION	QTY
RED ID LIGHT BAR - 9 DIODES			
MCL914R1PG	MCL914R1PGP	ID light bar, black base	10

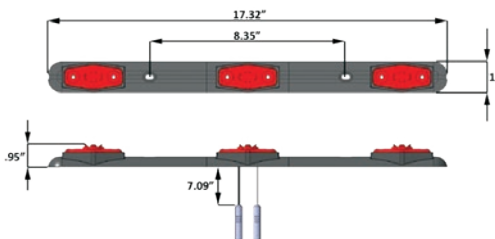

FMVSS	P2
MATERIALS	Polycarbonate lens and housing
VOLT/AMP	12.8VDC - 0.147A
WT/DIMS	.397 lb. / .287 lbs / 17.32" x 1.25" x .95"
WARRANTY	Lifetime LED Warranty

MCL84 SERIES

Sealed LED Identification Light Bar for Over 80" Applications



- Sonically sealed, waterproof lights snap onto stainless steel base
- Design includes both lead and ground wire



MCL84RB

BULK P/N	POLYPACK P/N	DESCRIPTION	QTY
RED ID LIGHT BAR - 9 DIODES			
MCL84RB	MCL84RBP	9-LED ID light bar	10
AL91RB	AL91RBP	3-LED replacement light	50

FMVSS	P2
MATERIALS	Polycarbonate light, stainless steel housing
VOLT/AMP	12.8VDC - .153A
WT/DIMS	.397 lb. / 16.5" x 1.375" x 1.625"
WARRANTY	Lifetime LED Warranty

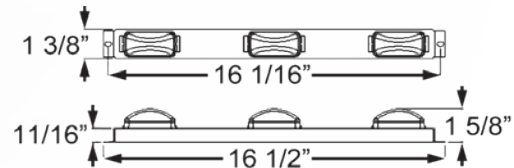

MCL97 SERIES

Sealed LED Identification Light Bar for Over 80" Applications



- Sealed, waterproof lights on stainless steel base
- Single wire, grounds through mounting hardware



MCL97RB

BULK P/N	POLYPACK P/N	DESCRIPTION	QTY
RED ID LIGHT BAR - 9 DIODES			
MCL97RB	MCL97RBP	9-LED ID light bar	10
MCL97RPG	MCL97RPGP	9-LED ID light bar, .180 male bullet	10

RETAIL			
MCL97RK		ID light bar, slipover blister	6

FMVSS	P2 P3
MATERIALS	Polycarbonate light, stainless steel base
VOLT/AMP	12.8VDC - .153A
WT/DIMS	.287 lb. / 14.25" x 1.188" x 1.313"
WARRANTY	Lifetime LED Warranty

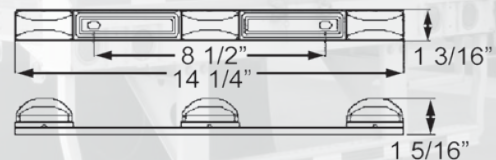



LPL11 SERIES Snap-In LED Mini License Plate Light

- Chrome-plated brass construction
- Easy snap-in mounting
- Sonically sealed, waterproof
- Two-wire design includes both lead and ground wire



LPL11CB

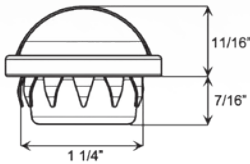
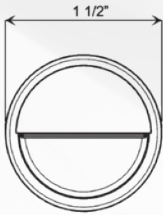

HOLE CUT-OUT: 1.25"

BULK P/N	POLYPACK P/N	DESCRIPTION	QTY
LICENSE LIGHT - 2 DIODES			
LPL11CB	LPL11CBP	Snap-in, license light	50
LPL11CPG	LPL11CPGP	Snap-in, license light, .180 male bullets	50

FMVSS	(2) L
MATERIALS	Polycarbonate lens and brass housing
VOLT/AMP	12.8VDC - .0306A
WT/DIMS	.068lbs. / 1.5" x 1.5" x 1.125"
WARRANTY	Lifetime LED Warranty

LPL12 SERIES 3/4" Sealed LED License Light

- Sealed, waterproof
- Meets SAE J587 when properly mounted using brackets listed below
- Design includes both lead and ground wire



LPL12CB

BULK P/N	POLYPACK P/N	DESCRIPTION	QTY
LICENSE LIGHT - 2 DIODES			
LPL12CB	LPL12CBP	Light with .180 female barrels	20
LPL12CPGB	LPL12CPGBP	Light with .180 male bullets	20
LPL12CKM2B	LPL12CKM2BP	Kit: LPL12CPGB, A12B2LPB surface mount bracket, A12GLPB grommet	50
LPL12CKMB	LPL12CKMBP	Kit: LPL12CPGB with A11BLPB bracket	20
LPL12CKF2B	LPL12CKF2BP	Kit: LPL12CB, A12B2LPB surface mount bracket, A12GLPB grommet	50
ACCESSORIES			
A11BLPB	A11BLPBP	Black flush mount bracket	50
A11GLPB	A11GLPBP	Gray flush mount bracket	50
A12B2LPB	A12B2LPBP	Black vertical mount bracket	50
A12GLPB	A12GLPBP	Grommet for A12B2LPB	50

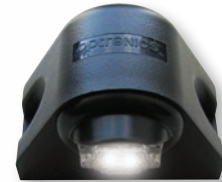

Kit with A12B2LPB bracket



LPL12CKMB

FMVSS	L
MATERIALS	Polycarbonate lens and housing
VOLT/AMP	12.8VDC - 0.11A
WT/DIMS	.022 lb. / 0.74" x 0.74" x .938"
WARRANTY	Lifetime LED Warranty

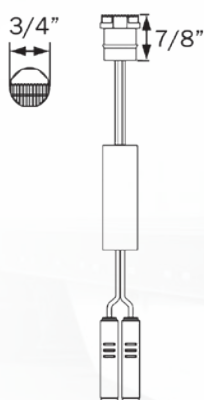

LPL12CB

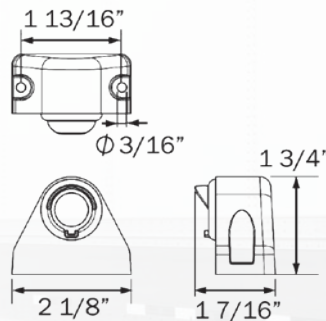

A12B2LPB

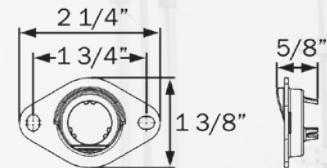

A11GLPB



LPL21CB

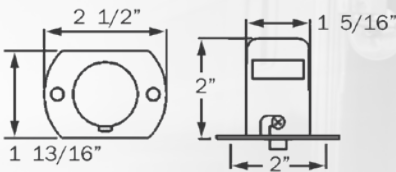

LPL21 SERIES

LED Heavy Duty License Plate Light

- Armored light made of durable, chrome plated steel
- Surface mount on 2" centers
- Design includes both lead and ground wire

BULK P/N	POLYPACK P/N	DESCRIPTION	QTY
LICENSE LIGHT - 1 DIODE			
LPL21CB	LPL21CBP	Armored license light	20
FMVSS	L		
MATERIALS	Steel, polycarbonate lens		
VOLT/AMP	12.8VDC - 0.054A		
WT/DIMS	.132 lb. / 2.5" x 1.813" x 2"		
WARRANTY	Lifetime LED Warranty		



LPL31CB



LPL31CSB

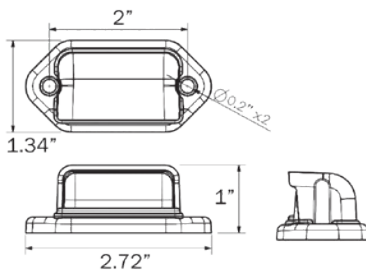

LPL31CB

LPL31 SERIES

Mini LED License Light

- Polished, chrome plated housing
- Surface mount on 2" centers
- Design includes both lead and ground wire
- Two LPL31CB/CEZB required to meet DOT requirements, mounted on each side
- Single LPL31CSB required to meet DOT requirements, mounted at center

BULK P/N	POLYPACK P/N	DESCRIPTION	QTY
LICENSE LIGHT - 2 DIODES			
LPL31CB	LPL31CBP	License light	20
LPL31C1PG	LPL31C1PGP	License light, .180 male bullets	20
LPL31CPG	LP31CPGP	License light, .156 female barrels	20
LPL31CEZB	LPL31CEZBP	License light, .180 female barrels	20
LPL31CSB	LPL31CSBP	Light with spacer	50
LPLB31CPG	LPLB31CPGP	Light with black bracket, .156 female barrels	25

RETAIL

LPL31CS		Light with mounting hardware, clam	12
---------	--	------------------------------------	----

FMVSS	(2) L		
MATERIALS	Polycarbonate lens, chrome plated stainless steel bezel		
VOLT/AMP	12.8VDC - 0.027A		
WT/DIMS	.066 lb. / 2.72" x 1.34" x 1"		
WARRANTY	Lifetime LED Warranty		

LPL41/42/43 SERIES Surface Mount LED License Light

- Armored housing
- Surface mount using stainless steel ears or studs
- Design includes both lead and ground wire

BULK P/N	POLYPACK P/N	DESCRIPTION	QTY
LICENSE LIGHT			
LPL41CB	LPL41CBP	5-LED ear mount license light, chrome finish housing	20
LPL42CBF	LPL42CBFP	5-LED stud mount license light, chrome finish housing	20
LPL43CB	LPL43CBP	3-LED ear mount license light, stainless steel base	20
LPL43CGBF	LPL43CGBFP	3-LED stud mount license light, self grounding	20

FMVSS	L
MATERIALS	Polycarbonate lens, chrome plated plastic housing, stainless steel base
VOLT/AMP	12.8VDC - 0.054A
WT/DIMS	.176 lb. / 4" x 2.188" x 1.563"
WARRANTY	Lifetime LED Warranty



LPL41CB



LPL43CB

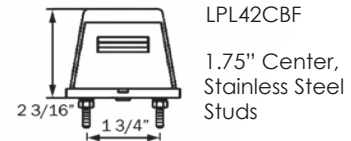
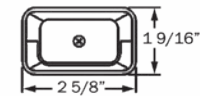
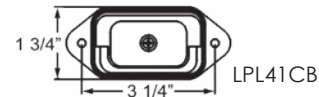

LPL55/56 SERIES LED License Light with Bracket

- Light attached to corrosion proof black bracket
- Surface mount on 3-1/4" centers
- Design includes both lead and ground wire

BULK P/N	POLYPACK P/N	DESCRIPTION	QTY
LICENSE LIGHT - 5 DIODES			
LPL55CB	LPL55CBP	Light with ABS bracket	10
LPL55CPG	LPL55CPGP	Light with ABS bracket, female PL-10 plug	10
LPL55CKB	LPL55CKBP	Light/bracket, gasket and hardware	10
LPL56CB	LPL56CBP	Light with steel bracket and gasket	10

FMVSS	L
MATERIALS	Polycarbonate lens and housing, plastic bracket
VOLT/AMP	12.8VDC - 0.045A
WT/DIMS	.198 lb. / 8.625" x 3.25" x 2.375"
WARRANTY	Lifetime LED Warranty



LPL55CB

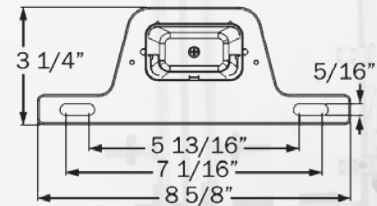



LPL57CB

LPL57 SERIES

LED License Light with Bracket

- One-piece design, light molded into bracket
- Surface mount, low profile
- Hard wired, with both lead and ground wires

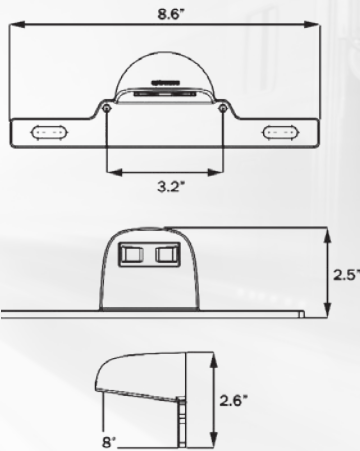

BULK P/N	POLYPACK P/N	DESCRIPTION	QTY
LICENSE LIGHT - 1 DIODE			
LPL57CB	LPL57CBP	Light with bracket	10
LPL57CKB	LPL57CKBP	Kit: light with bracket, mounting hardware	10
ACCESSORIES			
LP52HP	LP52HPP	Mounting hardware: two bolts, two washers, two weld nuts	50
FMVSS	L		
MATERIALS	Polycarbonate lens and housing, plastic bracket		
VOLT/AMP	12.8VDC - 0.054A		
WT/DIMS	.198 lb. / 8.6" x 2.5" x 2.6"		
WARRANTY	Lifetime LED Warranty		

LPL58/59 SERIES LED Single Piece Molded License Lights

- Stud mount and ear mount models available
- Chrome finish plastic housing
- Design includes both lead and ground wire
- Available in bulk and polypack packaging

BULK P/N	POLYPACK P/N	DESCRIPTION	QTY
LICENSE LIGHT - 1 DIODE			
LPL58CB	LPL58CBP	License light, 2-wire, stud mount	20
LPL59CB	LPL59CBP	License light, 2-wire, ear mount	20

FMVSS	L
MATERIALS	Chrome finish plastic housing, polycarbonate lens
VOLT/AMP	12VDC - .054A
WT/DIMS	LPL58: .13lbs 2.55" x 2.88" x 1.47" LPL59: .13lbs 4.13" x 2.71" x 1.88"
WARRANTY	Lifetime LED Warranty



LPL58CB



LPL59CB

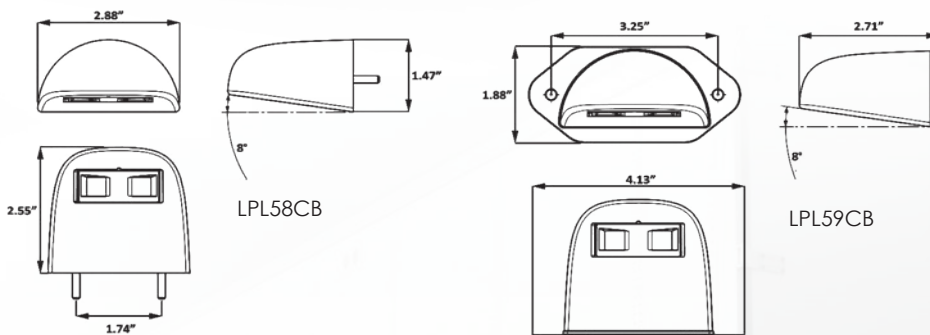



LPL61C24B

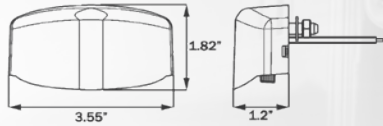

LPL61 SERIES LED License Light

- Sonically sealed, waterproof
- Dual power - use with 12V and 24V systems
- Corrosion proof polycarbonate construction
- Design includes both lead and ground wire

BULK P/N	POLYPACK P/N	DESCRIPTION	QTY
----------	--------------	-------------	-----

LICENSE LIGHT - 6 DIODES

LPL61C24B	LPL61C24BP	LED license light, black housing, 12-24V	50
LPL61C24PG	LPL61C24PGP	LED license light, black housing, 12-24V .156 female barrels	10

FMVSS	L
MATERIALS	Polycarbonate
VOLT/AMP	12.8VDC - 0.02A
WT/DIMS	.132 lb. / 3.55" x 1.2" x 1.82"
WARRANTY	Lifetime LED Warranty



LPL65CB



LPL65CBB

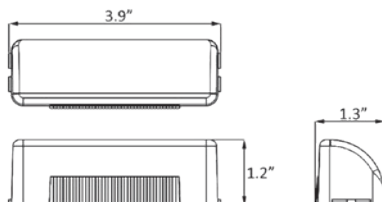

LPL65 SERIES LED License Light

- Sonically sealed, waterproof
- Accept standard 1- or 2-wire plugs
- Single wire design grounds through mounting hardware
- Two-wire design includes both lead and ground wire for mounting to all surfaces

BULK P/N	POLYPACK P/N	DESCRIPTION	QTY
----------	--------------	-------------	-----

LICENSE LIGHT - 3 DIODES

LPL65CB	LPL65CBP	LED license light, gray housing	20
LPL65CBB	LPL65CBBP	LED license light, black housing	20

ACCESSORIES

A65PB	A65PBP	Kit: A65B bracket, A65P plug	50
A66PB	A66PBP	Kit: grey bracket, A65P plug	50
A67CB	A67CBP	Kit: chrome bracket, A65P plug	50
A68PG	A68PBP	Kit: A65B bracket, A68P plug	50

FMVSS	L
MATERIALS	Polycarbonate lens and housing
VOLT/AMP	12.8VDC - 0.052A
WT/DIMS	.089 lb. / 3.9" x 1.3" x 1.2"
WARRANTY	Lifetime LED Warranty

LPL81 SERIES

Sealed LED Ear Mount License Light

- Sealed, waterproof electronics
- Surface ear mount
- Design includes both lead and ground wire

BULK P/N	POLYPACK P/N	DESCRIPTION	QTY
LICENSE LIGHT - 3 DIODES			
LPL81CB	LPL81CBP	License light, stainless steel mounting ears	20

FMVSS	L
MATERIALS	Polycarbonate lens, ABS housing, stainless steel base
VOLT/AMP	12.8VDC - 0.035A
WT/DIMS	.162 lbs / 4" x 2" x 1.91"
WARRANTY	Lifetime LED Warranty



LPL81CB

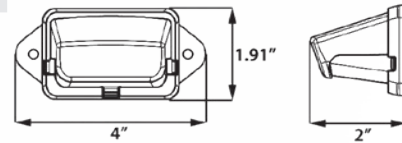

LPL82 SERIES

Sealed LED Stud Mount License Light

- Sealed, waterproof electronics
- Stud mount on 1.75" centers
- Design includes both lead and ground wire

BULK P/N	POLYPACK P/N	DESCRIPTION	QTY
LICENSE LIGHT - 3 DIODES			
LPL82CB	LPL82CBP	License light, stud mount grey housing	20
LPL82CBB	LPL82CBBP	License light, stud mount black housing	20

FMVSS	L
MATERIALS	Polycarbonate lens and housing
VOLT/AMP	12.8VDC - 0.035A
WT/DIMS	.131 lbs / 2.87" x 2" x 1.91"
WARRANTY	Lifetime LED Warranty



LPL82CB



LPL82CBB

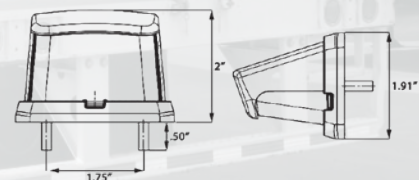



LPL91



LPL26SKB

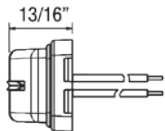
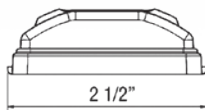
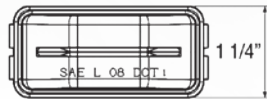

LPL91

LPL91 SERIES Sealed LED License Light

- Sonically sealed, waterproof
- Use with LP25SB bracket and designated license plate brackets
- Design includes both lead and ground wire

BULK P/N	POLYPACK P/N	DESCRIPTION	QTY
LICENSE LIGHT - 2 DIODES			
LPL91CB	LPL91CBP	License light	50
LPL91CAB	LPL91CABP	License light, .156 female plugs	50
LPL91CPG	LPL91CPGP	License light, female PL-10 connector	50
LPL91CKALPB	LPL91CKALBPB	License light, .150 female barrels, black light bracket, gasket	50
LPL26SKB	LPL26SKBP	License light, .180 male bullets, gray light bracket	50
LICENSE PLATE BRACKETS			
LP25SB	LP25SBP	Bracket, black coated	100
LP25SGB	LP25SGBP	Bracket, gray coated	
LP5SB	LP5SBP	Straight license plate bracket	100
LP15SB	LP15SBP	Zinc license plate bracket	12
LP35BB	LP35BBP	License plate holder	25
ACCESSORIES			
A91BB	A91BBP	Black base, self grounding	100
A91BOB	A91BOBP	Black base, open back	100
A91CB	A91CBP	Chrome base, self grounding	100
A91OB	A91OBP	Chrome base, open back	100
A91GB	A91GBP	Grommet	100
RETAIL			
LPL91CS		Light, clam	12

FMVSS	L
MATERIALS	Polycarbonate lens and housing
VOLT/AMP	12.8VDC - 0.027A
WT/DIMS	.066 lb. / 2.5" x 1.25" x 0.813"
WARRANTY	Lifetime LED Warranty

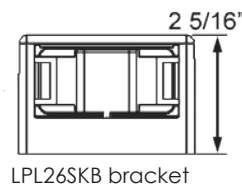
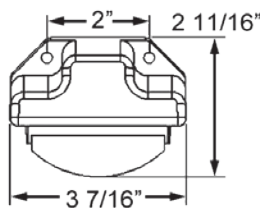

LPL26SKB bracket

BUL13 SERIES

4" Round Sealed LED Utility Light

- Miro-Flex™ design with Crystal Clear™ lens
- Sonically sealed, waterproof
- Accepts standard two-pin plugs

BULK P/N	POLYPACK P/N	DESCRIPTION	QTY
UTILITY LIGHT - 12 DIODES			
BUL13CB	BUL13CBP	Utility light	10
ACCESSORIES			
A45GB	A45GBP	Grommet	50
A45CB	A45CBP	Pigtail, 2-wire	100
A49PB	A49PBP	Right angle pigtail, 2-wire	100
MATERIALS	Polycarbonate lens and housing		
VOLT/AMP	12.8VDC - 0.074A		
WT/DIMS	.331 lb. / 4.313" x 4.313" x 2.375"		
WARRANTY	Lifetime LED Warranty		



BUL13CB

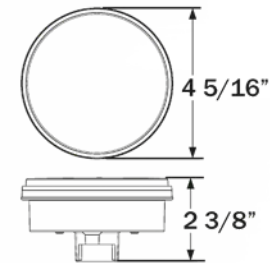

BUL43 SERIES

4" Round Sealed LED Utility Light

- Crystal Clear™ lens
- Sonically sealed, waterproof
- Accepts standard two-pin plugs

BULK P/N	POLYPACK P/N	DESCRIPTION	QTY
UTILITY LIGHT - 10 DIODES			
BUL43CB	BUL43CBP	Utility light	10
BUL43CBK	BUL43CBKP	Kit with A45GB grommet and A45CB pigtail	10
ACCESSORIES			
A45GB	A45GBP	Grommet	50
A45CB	A45CBP	Pigtail, 2-wire	100
A49PB	A49PBP	Right angle pigtail, 2-wire	100
MATERIALS	Polycarbonate lens and housing		
VOLT/AMP	12.8VDC - 0.275A		
WT/DIMS	.529 lb. / 4.313" x 4.313" x 1.938"		
WARRANTY	Lifetime LED Warranty		



BUL43CB

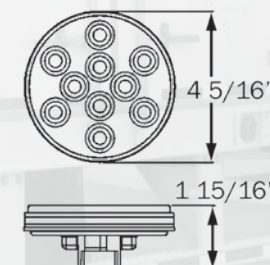



BUL69 SERIES Sealed LED Thinline Utility Light



BUL69CB

- Sonically sealed, waterproof
- Ultra thin – only 5/8" thick
- Design includes both lead and ground wire

BULK P/N	POLYPACK P/N	DESCRIPTION	QTY
UTILITY LIGHT - 11 DIODES			
BUL69CB	BUL69CBP	Utility light	10
BUL69CPG	BUL69CPGP	Light with .180 male bullets	10
BUL69CBMCV2B	BUL69CBMCV2BP	Kit: 2-wire female PL-3, A69CB base	10
ACCESSORIES			
A69CB	A69CBP	Chrome base/bezel	10
A69GB	A69GBP	Gasket	50

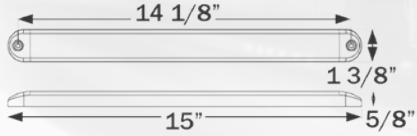

MATERIALS	Polycarbonate lens and housing
VOLT/AMP	12.8VDC - 0.025A
WT/DIMS	.265 lb. / 15" x 1.375" x .625"
WARRANTY	Lifetime LED Warranty



BUL72 SERIES 6" Oval Sealed LED Utility Lights



BUL72CB



BUL72CBGK

- Crystal Clear™ lens
- Sonically sealed, waterproof
- Accepts standard two-pin plugs

BULK P/N	POLYPACK P/N	DESCRIPTION	QTY
UTILITY LIGHT - 10 DIODES			
BUL72CB	BUL72CBP	Utility light	10
BUL72CBGK	BUL72CBGKP	Utility light with A70GB grommet	50
BUL74CBK	BUL74CBKP	Utility light with A70GB & A49PB	50
ACCESSORIES			
A70GB	A70GBP	Grommet	50
A45CB	A45CBP	Pigtail, 2-wire	100
A49PB	A49PBP	Right angle pigtail, 2-wire	100

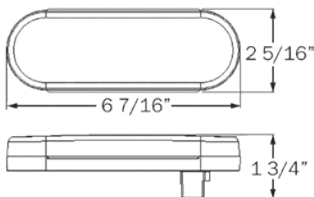

MATERIALS	Polycarbonate lens and housing
VOLT/AMP	12.8VDC - 0.080A
WT/DIMS	.529 lb. / 6.438" x 2.313" x 1.75"
WARRANTY	Lifetime LED Warranty

BUL73 SERIES

FLEET Count™ 6" Oval Sealed LED Utility Light for Surface Mount

- Sonically sealed, waterproof
- Surface flange mount – no panel cutout required
- Design includes both lead and ground wire

BULK P/N	POLYPACK P/N	DESCRIPTION	QTY
UTILITY LIGHT - 6 DIODES			
BUL73CB	BUL73CBP	Utility light	10
ACCESSORIES			
A78CB1	A78CB1P	Chrome snap-on trim ring	25

MATERIALS	Polycarbonate lens and housing
VOLT/AMP	12.8VDC - 0.054A
WT/DIMS	.265 lb. / 7.563" x 3.313" x .75"
WARRANTY	Lifetime LED Warranty



BUL73CB

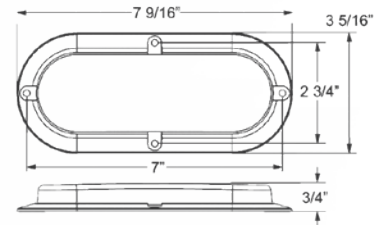

BUL78 SERIES

6" Oval Sealed LED Utility Light for Surface Mount

- Sonically sealed, waterproof
- Surface flange mount – no panel cutout required
- Design includes both lead and ground wire

BULK P/N	POLYPACK P/N	DESCRIPTION	QTY
UTILITY LIGHT - 10 DIODES			
BUL78CB	BUL78CBP	Utility light	10
BUL78CEZB	BUL78CEZBP	Utility light with 2-way female PL-3	10
BUL78C3MB	BUL78C3MBP	Utility light with 2-way female PL-3 plug, adhesive back	10
BUL28CLPB	BUL28CLPBP	Low profile utility light with 2-way female PL-3 connector and gasket	10

ACCESSORIES			
A78CB1	A78CB1P	Chrome snap-on trim ring	25
A78RXB	A78RXBP	Red reflex snap-on trim ring	25
A178TRSSB	A178TRSSBP	Stainless steel screw mount trim ring	50

MATERIALS	Polycarbonate lens and housing
VOLT/AMP	12.8VDC - 0.054A
WT/DIMS	BUL78: .265 lb. / 7.563" x 3.313" x .75" BUL28: .255 lb. / 7.50" x 3.313" x .5625"
WARRANTY	Lifetime LED Warranty



BUL78CB

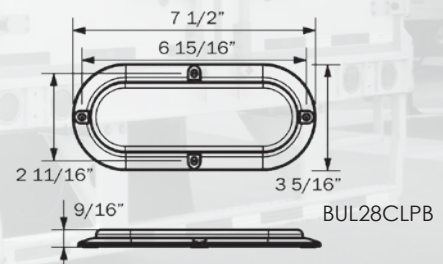
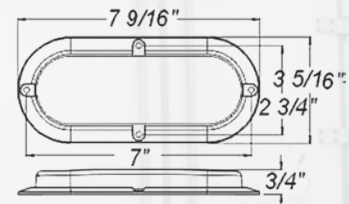



ILLO1 SERIES

3/4" LED Emergency Egress Light



- 3/4" recess mount light for use in transit vehicles
- Hard wired, includes lead and ground with female Staykon connectors
- Sealed, waterproof construction – maintenance free
- Snap-in design for quick and easy installation

BULK P/N	BOX/UPC P/N	DESCRIPTION	QTY
EGRESS LIGHT - 1 DIODE			
ILL01RB	ILL01RBP	3/4" egress light	50

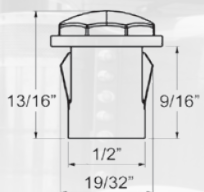

MATERIALS	Polycarbonate lens and housing
VOLT/AMP	12.8VDC - .1A
WT/DIMS	0.018 lb. / .695" x .695" x .81"
WARRANTY	Lifetime LED Warranty



ILLO6/07 SERIES

Opti-Brite™ LED Mini Dome Light



ILL06COB

- Compact 11-inch dome light fits many applications
- Design includes 6-inch, 16-gauge power and ground wires with tinned ends
- Available with neutral white or cool white LEDs



A06TR

BULK P/N	POLYPACK P/N	DESCRIPTION	QTY
COOL WHITE - 16 DIODES			
ILL06COB	ILL06COBP	Dome light, white trim ring	12
NEUTRAL WHITE - 16 DIODES			
ILL07COB	ILL07COBP	Neutral white LEDs	12
ACCESSORIES			
A06TR	A06TRP	White trim ring	50

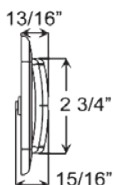
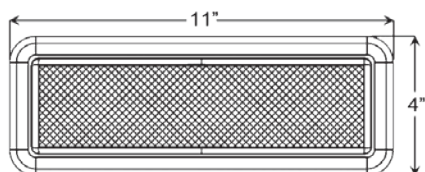

Raw lumen output: 643 lm
Effective lumen output: 354 lm

MATERIALS	Polycarbonate lens and housing
VOLT/AMP	12.8VDC - .48A
WT/DIMS	.05 lbs. / 11" x 4" x .94"
WARRANTY	Lifetime LED Warranty

ILL08/ILL28 SERIES

Opti-Brite™ LED Dome Lights

- Designed for use in extreme temperatures; ideal for refrigerated trucks and trailers (-40 to 140 degrees F)
- Operating voltage 7-30VDC; voltage cut-off at 7VDC prevents battery drain
- Use with both 12VDC and 24VDC systems; light output remains consistent at all operating voltages (no dimming), cutting off when voltage is outside range
- Design includes 16-inch, 16-gauge power and ground wires with tinned ends



BULK P/N	BOX/UPC P/N	DESCRIPTION	QTY
DOME LIGHT - 8 DIODES			
ILL08COB	ILL08COBP	Light	6
ILL08COPG	ILL08COPGP	Light, .180 male bullets	6
MOTION SENSOR DOME LIGHT - 8 DIODES			
ILL28CMB	ILL28CMBP	Light with motion sensor	6
ILL28CMPG	ILL28CMPGP	Light with motion sensor, .180 male bullets	6

Raw lumen output: 1400 lm
Effective lumen output: 990 lm

MATERIALS	Polycarbonate lens and housing
VOLT/AMP	12.8VDC - 1.61A; 24VDC - 0.80A
WT/DIMS	1 lb. / 18.25" x 5.75" x 1.078"
WARRANTY	Lifetime LED Warranty

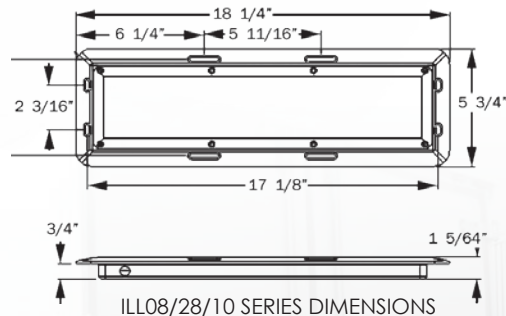

ILL10 SERIES

Opti-Brite™ LED Dome Light

For 12VDC systems, general applications

BULK P/N	BOX/UPC P/N	DESCRIPTION	QTY
DOME LIGHT - 10 DIODES			
ILL10CCB	ILL10CCBP	11-16VDC Dome light	6

Raw lumen output: 1100 lm
Effective lumen output: 880 lm

MATERIALS	Polycarbonate lens and housing
VOLT/AMP	12.8VDC - 1.8A
WT/DIMS	1 lb. / 18.25" x 5.75" x 1.078"
WARRANTY	Lifetime LED Warranty





ILL11 SERIES

Opti-Brite™ LED Dome Lights

- Designed for extreme temperatures; ideal for refrigerated trucks and trailers (-40 to 185 degrees F)
- Color temperature of light: 5300-7000K
- Design includes 18-inch, 16-gauge power and ground wires with tinned ends



ILL11CCB

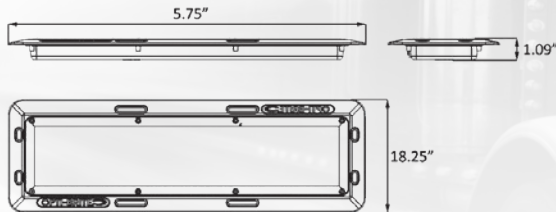

BULK P/N	BOX/UPC P/N	DESCRIPTION	QTY
DOMELIGHT - 10 DIODES			
ILL11CCB	ILL11CCBP	Light	6

Raw lumen output: 1100 lm
Effective lumen output: 880 lm

MATERIALS	Polycarbonate lens and housing
VOLT/AMP	12.8VDC - 1.33A
WT/DIMS	1.43 lbs / 18.25" x 5.75" x 1.09"
WARRANTY	Lifetime LED Warranty

ILL21 SERIES

Opti-Brite™ LED 6" Dome Light

- Low profile dome light – less than 5/8" thick
- Operating voltage 12-24VDC; use with both 12VDC and 24VDC systems
- Low voltage cut-off at 11VDC, prevents battery drain
- Sealed, waterproof

BULK P/N	POLYPACK P/N	DESCRIPTION	QTY
DOMELIGHT - 21 DIODES			
ILL21CB	ILL21CBP	Dome light, two-wire, .180 male bullets	10
ILL21CTPB	-	ILL21CB with adhesive mounting pad	10
ACCESSORIES			
A21CHB	-	Chrome trim ring	25

Raw lumen output: 250 lm
Effective lumen output: 214 lm

MATERIALS	Polycarbonate lens and housing
VOLT/AMP	12.8VDC - .408A; 24VDC - .385A
WT/DIMS	.250 lb. / 6.0938" x 6.0938" x .625"
WARRANTY	Lifetime LED Warranty



ILL21CB

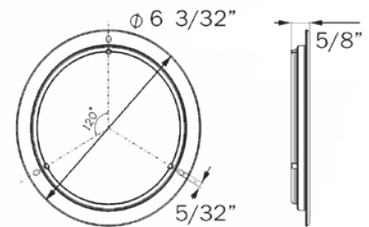

ILL22 SERIES

Sealed LED Dome Lights

- Low profile dome lights – only 1" thick
- Sealed, waterproof design
- Hard wired with 6" power and ground wires

BULK P/N	POLYPACK P/N	DESCRIPTION	QTY
DOMELIGHT - 18 DIODES			
ILL22CB	ILL22CBP	Dome light, on/off switch	10
ILL22C1224B	ILL22C1224BP	Dome light, on/off switch, 12/24V	10
ILL22CBB	ILL22CBBP	Dome light, on/off switch, black circuit board	10
ILL22CHB	ILL22CHBP	Dome light, no switch	10

RETAIL			
ILL22CFS		Dome light, clam	12

Raw lumen output: 1044 lm
Effective lumen output: 810 lm

MATERIALS	Polycarbonate lens and housing
VOLT/AMP	12.8VDC - .7A
WT/DIMS	.182 lb. / 4.5" x 2.875" x 1"
WARRANTY	Lifetime LED Warranty



ILL22CB



ILL22CBB

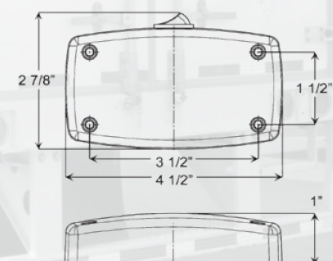



ILL124CPG

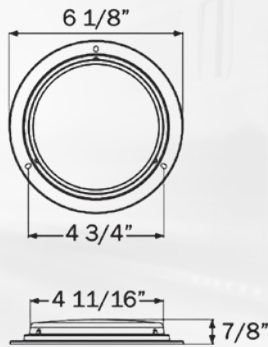

ILL124 SERIES Opti-Brite™ LED 6" Dome Light

- Low profile dome lights – only 7/8" thick
- Sealed, waterproof
- Hard wired design includes power and ground wires

BULK P/N	POLYPACK P/N	DESCRIPTION	QTY
DOMELIGHT - 36 DIODES			
ILL124CPG	ILL124CPGP	Dome light, .180 male bullets	10

Raw lumen output: 585 lm
Effective lumen output: 431 lm

MATERIALS	Polycarbonate lens and housing
VOLT/AMP	12.8VDC - 0.127A
WT/DIMS	.353 lb. / 6.125" x 6.125" x 0.875"
WARRANTY	Lifetime LED Warranty



ILL24CB

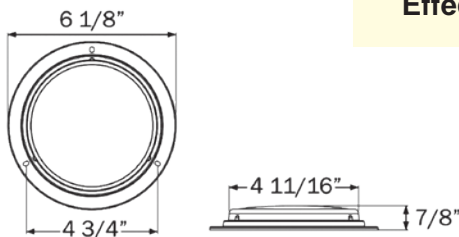

ILL24 SERIES Sealed LED 6" Dome Light

- Low profile dome light – only 7/8" thick
- Sealed, waterproof
- Hard wired design includes power and ground wires

BULK P/N	POLYPACK P/N	DESCRIPTION	QTY
DOMELIGHT - 36 DIODES			
ILL24CB	ILL24CBP	Dome light	10
ILL24CPG	ILL24CPGP	Dome light, .180 male bullets	10

Raw lumen output: 585 lm
Effective lumen output: 453 lm

MATERIALS	Polycarbonate lens and housing
VOLT/AMP	12.8VDC - .127A
WT/DIMS	.353 lb. / 6.125" x 6.125" x 0.875"
WARRANTY	Lifetime LED Warranty

ILL29 Series Opti-Brite™ 4" LED Dome Lights

- Sonically sealed, waterproof
- Recess mount design
- Available in grommet and flange mount models
- Hard wired with .180 male bullets

BULK P/N	POLYPACK P/N	DESCRIPTION	QTY
DOMELIGHT - 7 DIODES			
ILL29CB	ILL29CBP	Dome light, grommet mount	10
ILL29CFB	ILL29CFBP	Dome light, flange mount	10
ACCESSORIES			
A45GB	A45GBP	PVC grommet	50
A46GB	A46GBP	PVC grommet, new design	50

Raw lumen output: 500 lm
Effective lumen output: 360 lm

MATERIALS	Polycarbonate lens and housing
VOLT/AMP	12.8VDC - 0.3A
WT/DIMS	Grommet: .26 lb / 4.25" x 4.25" x .9" Flange: .3 lb / 5.5" x 5.5" x .9"
WARRANTY	Lifetime LED Warranty

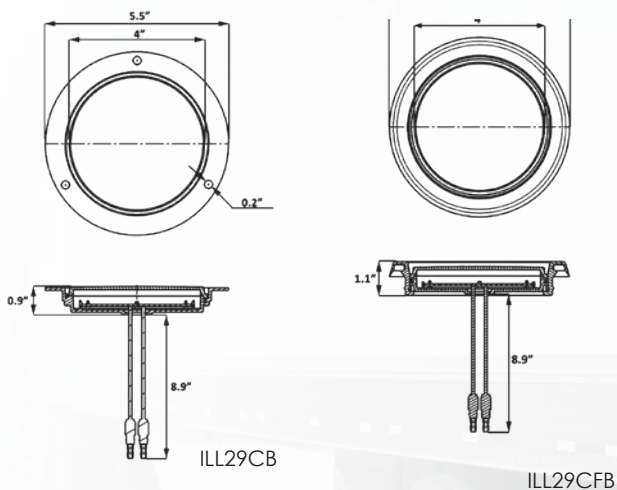



ILL30CBB SERIES Constellation™ LED Bullet Light

- Surface mount fixture; trim ring covers mounting hardware
- Ratchet motion design with on/off switch
- Lightly frosted lens
- Hard wired design includes power and ground wires



ILL30CBB

BULK P/N	POLYPACK P/N	DESCRIPTION	QTY
BULLET LIGHT - 1 DIODE			
ILL30CBB	ILL30CBBP	Bullet light	25

MATERIALS	Plastic housing
VOLT/AMP	12.8VDC - .288A
WT/DIMS	.250 lb. / 3.75" x 1.938" x 3.5"
WARRANTY	Lifetime LED Warranty



ILL31/32/35 SERIES LED Low Profile Dome Lights

- Low profile dome lights for semi-recess or surface mount
- Durable steel housing and replaceable polycarbonate lens
- Hard wired design includes power and ground wires
- Select from standard diode or SMD LED models



ILL31CB

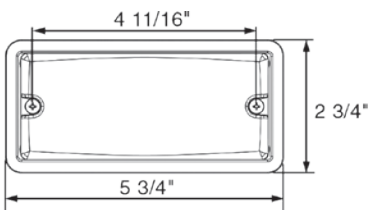

ILL31/32/35



ILL31/35 - recess mount



ILL32 - surface mount

BULK P/N	POLYPACK P/N	DESCRIPTION	QTY
RECESS MOUNT DOME LIGHT - 10 DIODES			
ILL31CB	ILL31CBP	Standard LED	10
ILL35CB	-	SMD LED	10
SURFACE MOUNT DOME LIGHT - 10 DIODES			
ILL32CB	ILL32CBP	SMD LED	10
ILL32CPG	-	SMD LED, .180 male bullets	10

Raw lumen output: 70 lm

Effective lumen output: 53 lm

MATERIALS	Polycarbonate lens, plated steel housing
VOLT/AMP	12.8VDC - .024A
WT/DIMS	ILL31/35: .243 lb. / 5.75" x 2.75" x .938" ILL32: .243 lb. / 5.75" x 2.75" x .75"
WARRANTY	Lifetime LED Warranty

ILL33 SERIES

Opti-Brite™ LED Sealed Dome Light

- Low profile surface mount design – less than 3/4" thick
- Hard wired design includes 18-gauge lead wires
- Sealed, waterproof

BULK P/N	POLYPACK P/N	DESCRIPTION	QTY
DOMELIGHT - 10 DIODES			
ILL33CB	ILL33CBP	Dome light	10

Raw lumen output: 210 lm
Effective lumen output: 160 lm

MATERIALS	Polycarbonate lens and housing
VOLT/AMP	12.8VDC - .147A
WT/DIMS	.154 lb. / 5.125" x 2.25" x .75"
WARRANTY	Lifetime LED Warranty



ILL33CB

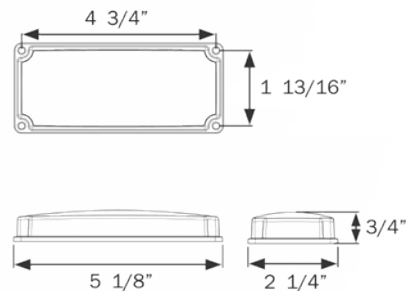

ILL36 SERIES

Opti-Brite™ LED Sealed Dome Light

- Low profile surface mount design – less than 3/4" thick
- Sealed, waterproof
- Durable polycarbonate construction

BULK P/N	POLYPACK P/N	DESCRIPTION	QTY
DOMELIGHT - 9 DIODES			
ILL36CB	ILL36CBP	Dome light	10
ILL36CPG	ILL36CPGP	Dome light, .180 male bullets	10

Raw lumen output: 400 lm
Effective lumen output: 227 lm

MATERIALS	Polycarbonate lens and housing
VOLT/AMP	12.8VDC - .33A
WT/DIMS	.154 lb. / 5.75" x 2.75" x .688"
WARRANTY	Lifetime LED Warranty



ILL36CB

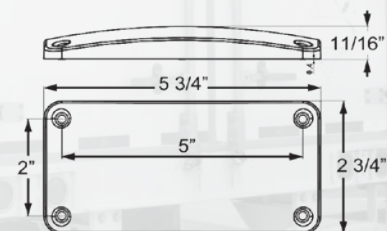



ILL38CMB LED Corner Mount Interior Lamp



ILL38CMB



- Modular design with PIR-based motion sensor for interior cargo applications
- 30 ultra-bright white SMD LED's
- Dual power 12/24VDC
- Operating environment -4° to 140° F
- 16-inch leads

BULK P/N	POLYPACK P/N	DESCRIPTION	QTY
INTERIOR LIGHT - 30 DIODES			
ILL38CMB	ILL38CMBP	Corner mount interior lamp, hard wired	20

MATERIALS	Polycarbonate lens, metal housing with white finish
VOLT/AMP	12/24VDC
WT/DIMS	.89 lb. / 17.72" x 2.45" x 2.22"
WARRANTY	Lifetime LED Warranty

ILL39 SERIES

Opti-Brite™ LED 7" Dome Light

- Low profile dome light – less than 5/8" thick
- Operating voltage 12-24VDC; use with both 12VDC and 24VDC systems
- Low voltage cut-off at 11VDC, prevents battery drain
- Hard wired design includes 16-gauge power and ground wires with .180 male bullets
- Sealed, waterproof

BULK P/N	POLYPACK P/N	DESCRIPTION	QTY
DOMELIGHT - 39 DIODES			
ILL39CB	ILL39CBP	Dome light	5/10
ILL39RCB	ILL39RCBP	Dome light, red diodes, .180 male bullets, 11V voltage cut-off	5

Raw lumen output: 460 lm
Effective lumen output: 390 lm

MATERIALS	Polycarbonate lens and housing
VOLT/AMP	12.8VDC - .669A; 24VDC - .217A
WT/DIMS	.350 lb. / 6.969" x 6.969" x .625"
WARRANTY	Lifetime LED Warranty

Opti-Brite



ILL39CB

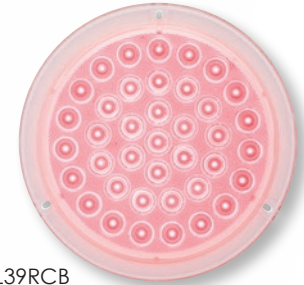

ILL39RCB

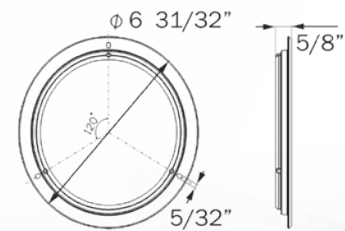

ILL45 SERIES

Opti-Brite™ LED Interior Light

- Low profile surface mount design – less than 1" thick
- Durable polycarbonate construction

BULK P/N	POLYPACK P/N	DESCRIPTION	QTY
INTERIOR LIGHT - 42 DIODES			
ILL45CB	ILL45CBP	Interior light	50

Raw lumen output: 300 lm
Effective lumen output: 260 lm

MATERIALS	Polycarbonate lens and housing
VOLT/AMP	12.8VDC - .37A
WT/DIMS	.206 lbs. / 4.625" x 4.625" x .79"
WARRANTY	Lifetime LED Warranty

Opti-Brite



ILL45CB

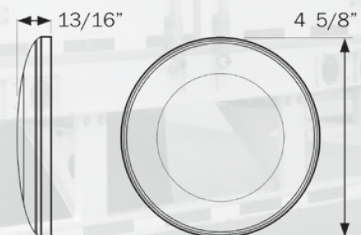



ILL46CB

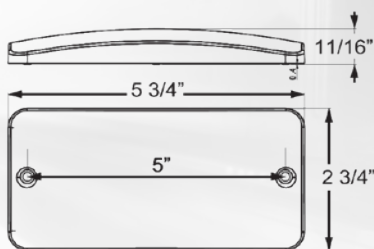

ILL46 SERIES Opti-Brite™ Sealed LED Dome Light

- Low profile surface mount design – less than 3/4" thick
- Sealed, waterproof
- Durable polycarbonate construction

BULK P/N	POLYPACK P/N	DESCRIPTION	QTY
DOME LIGHT - 9 DIODES			
ILL46CB	ILL46CBP	Dome light	10

Raw lumen output: 540 lm
Effective lumen output: 380 lm

MATERIALS	Polycarbonate lens and housing
VOLT/AMP	12.8VDC - .33A
WT/DIMS	.154 lbs. / 5.75" x 2.75" x .688"
WARRANTY	Lifetime LED Warranty



ILL48CB

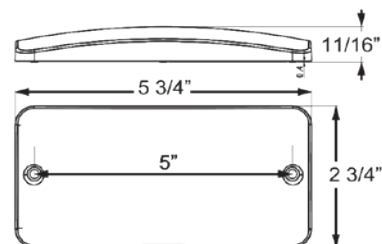

MOUNT ON 4.68" CENTERS

ILL48 SERIES Opti-Brite™ Sealed LED Dome Light

- Low profile surface mount design
- Sealed, waterproof
- Durable polycarbonate construction
- Hard wired with both power and ground wire
- Available in bulk and polypack packaging

BULK P/N	POLYPACK P/N	DESCRIPTION	QTY
DOME LIGHT - 9 DIODES			
ILL48CB	ILL48CBP	Dome light, 5-in. lead, black base	50

Raw lumen output: 540 lm
Effective lumen output: 380 lm

MATERIALS	Polycarbonate lens and housing
VOLT/AMP	12.8VDC - .33A
WT/DIMS	.154 lbs. / 5.75" x 2.75" x .69"
WARRANTY	Lifetime LED Warranty

ILL70/71/72 SERIES Opti-Brite™ LED Interior Strip Lights for Surface Mount

- Low profile, slimline lights – only 1" wide by 5/8" thick
- Hard wired design includes both lead and ground wires
- Select from 9-inch, 16-inch and 22-inch models
- Sealed, waterproof



ILL70CB



ILL71CB



ILL72CB

BULK P/N	POLYPACK P/N	DESCRIPTION	QTY
9" WHITE LED STRIP LIGHT - 9 DIODES			
ILL70CB	ILL70CBP	Strip light	20/10
ILL70CSB	ILL70CSBP	Strip light with on/off switch	10
ILL70C24B	ILL70C24BP	Strip light, 24-in. leads	10

Raw lumen output: 189 lm
Effective lumen output: 171 lm

16" WHITE LED STRIP LIGHT - 18 DIODES			
ILL71CB	ILL71CBP	Strip light	20/10
ILL71CSB	ILL71CSBP	Strip light with on/off switch	10
ILL71CPG	ILL71CPGP	Strip light, .180 male bullets	10

Raw lumen output: 370 lm
Effective lumen output: 342 lm

22" WHITE LED STRIP LIGHT - 27 DIODES			
ILL72CB	ILL72CBP	Strip light	20/10

Raw lumen output: 567 lm
Effective lumen output: 513 lm

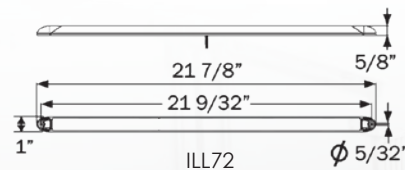
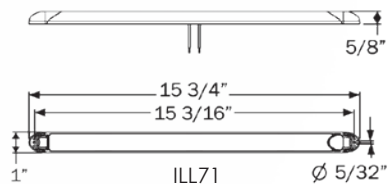
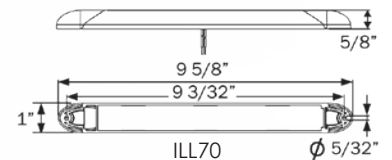

MATERIALS

Polycarbonate lens and housing

VOLT/AMP

ILL70: 12.8VDC - .150A

ILL71: 12.8VDC - .300A

ILL72: 12.8VDC - .480A

WT/DIMS

ILL70: .154 lb. / 9.625" x 1" x .625"

ILL71: .187 lb. / 15.75" x 1" x .625"

ILL72: .210 lb. / 21.875" x 1" x .625"

WARRANTY

Lifetime LED Warranty



ILL70/71 AWNING SERIES Opti-Brite™ LED Awning Lights for Surface Mount



ILL70CBAWN



ILL71CBAWN

- Low profile awning mount lights with wedge base that directs light at a 45-degree angle
- Hard wired design includes both lead and ground wires
- Select from 11-inch and 18-inch models
- Available in amber and white LED
- Sealed, waterproof

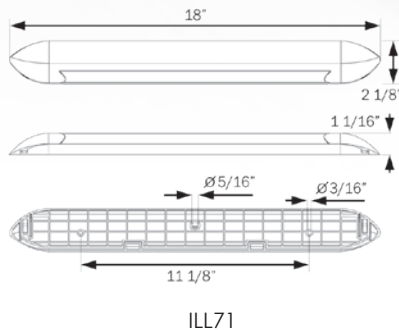
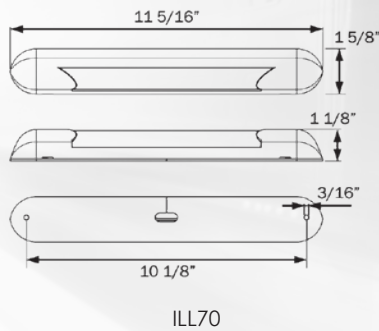

BULK P/N	POLYPACK P/N	DESCRIPTION	QTY
11" WHITE LED - 9 DIODES			
ILL70CBAWN	ILL70CBAWNP	No switch, chrome housing	10
ILL70CBBAWN	ILL70CBBAWNP	No switch, black housing	10
ILL70CBSBAWN	ILL70CBSBAWNP	On/off switch, black housing	10
ILL70CCSBAWN	ILL70CCSBAWNP	On/off switch, chrome housing	10

11" AMBER LED - 9 DIODES			
ILL70ABBAWN	ILL70ABBAWNP	No switch, black housing	10

RETAIL			
ILL70CBAWNFS		Light, no switch, chrome bezel	12
Raw lumen output: 189 lm			
Effective lumen output: 171 lm			

BULK P/N	POLYPACK P/N	DESCRIPTION	QTY
18" WHITE LED - 18 DIODES			
ILL71CBAWN	ILL71CBAWNP	No switch, chrome housing	10
ILL71C1BAWN	ILL71C1BAWNP	No switch, chrome housing, high lumen output	10

ACCESSORIES			
A71CBAWN	A71CBAWNP	Chrome base for ILL71CBAWN	10
A71CCBWAN	A71CCBWANP	Chrome base and bezel for ILL71CBAWN	10
A71C1BAWN	A71C1BAWNP	Chrome base for ILL71C1BAWN	25

RETAIL			
ILL71CBAWNFS		Light, no switch, chrome bezel	12
Raw lumen output: 370 lm			
Effective lumen output: 342 lm			

IP67 rating: protected from dust and capable of withstanding water immersion, offering increased reliability and service life

MATERIALS	Polycarbonate lens and housing
VOLT/AMP	ILL70: 12.8VDC - .150A ILL71: 12.8VDC - .300A
WT/DIMS	ILL70: .154 lb. / 11.313" x 1.625" x 1.125" ILL71: .187 lb. / 18" x 2.125" x 1.063"
WARRANTY	Lifetime LED Warranty

ILL85 SERIES

LED Exterior Step/Area Light

- Illuminate step well or pavement at base of steps or ramps
- Meets ADA lighting standard
- Surface mount, 3.662" mounting centers
- Hard wired design includes both lead and ground wires
- Operating voltage 8-30VDC, for use with 12VDC or 24VDC systems
- Polycarbonate construction with polished chrome finish
- Mounting gasket included



ILL85CB

BULK P/N	POLYPACK P/N	DESCRIPTION	QTY
STEP/AREA LIGHT - 10 DIODES			
ILL85CB	ILL85CBP	Step/area light	10

MATERIALS	Polycarbonate lens and housing
VOLT/AMP	12.8VDC - .107A
WT/DIMS	.154 lb. / 4.25" x 1.24" x 1.69"
WARRANTY	Lifetime LED Warranty

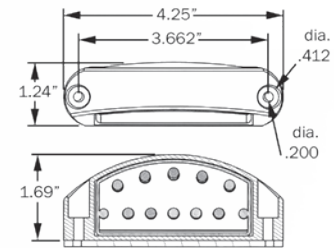

ILL86 SERIES

LED Exterior Step/Area Light

- Illuminate step well or pavement at base of steps or ramps
- Meets ADA lighting standard
- Surface mount, 2.92" mounting centers
- Hard wired design includes both lead and ground wires
- Die cast aluminum housing coated for protection against corrosion and UV exposure; polycarbonate lens



ILL86CB

ILL86BCB

BULK P/N	POLYPACK P/N	DESCRIPTION	QTY
STEP/AREA LIGHT - 5 DIODES			
ILL86CB	ILL86CBP	Step/area light, white finish	10
ILL86BCB	ILL86BCBP	Step/area light, black finish	10

MATERIALS	Die cast aluminum housing, polycarbonate lens
VOLT/AMP	12.8VDC - .25A
WT/DIMS	.154 lb. / 4" x 2.5" x 1.313"
WARRANTY	Lifetime LED Warranty





ILL87CB

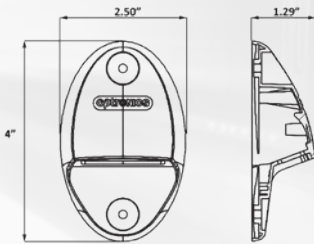

ILL87 SERIES LED ADA Exterior Step/Area Light

- Illuminate step well or pavement at base of steps or ramps
- Meets ADA lighting standard
- Surface mount, 2.92" mounting centers
- Hard wired design includes both lead and ground wires

BULK P/N	POLYPACK P/N	DESCRIPTION	QTY
STEP/AREA LIGHT - 5 DIODES			
ILL87CB	ILL87CBP	Step/area light	10

MATERIALS	Polycarbonate lens and housing
VOLT/AMP	12.8VDC - .17A
WT/DIMS	.231 lbs / 4" x 2.5" x 1.29"
WARRANTY	Lifetime LED Warranty



ILL91CB

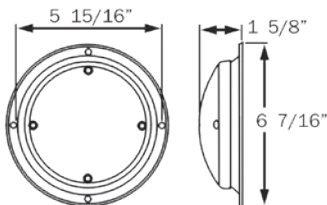

ILL91 SERIES 6" LED Interior Dome Light

- Surface mount steel base, chrome plated
- Hard wired design includes both lead and ground wires
- Two diodes provide low amp draw, bright white light

BULK P/N	POLYPACK P/N	DESCRIPTION	QTY
DOMELIGHT - 6 DIODES			
ILL91CB	ILL91CBP	Dome light	50
ILL91CPG	ILL91CPGP	Dome light, .180 male bullets	50

Raw lumen output: 600 lm

Effective lumen output: 540 lm

MATERIALS	Polycarbonate lens and housing
VOLT/AMP	12.8VDC - .35A
WT/DIMS	.154 lb. / 6.438" x 6.438" x 1.625"
WARRANTY	Lifetime LED Warranty

LM SERIES

LED Courtesy & Accent Lights

- LM315BB is semi-recess mount courtesy light
- LM835CB is eight-diode recess mount accent light with clear lens and chrome trim ring; screw mount
- All models are hard wired with ground wire

BULK P/N	POLYPACK P/N	DESCRIPTION	QTY
COURTESY LIGHT - 3 DIODES			
LM315BB	LM315BBP	Courtesy light, black	50
ACCENT LIGHT - 8 DIODE			
LM835CB	LM835CBP	Recess mount accent light	50

MATERIALS	Polycarbonate lens and housing		
VOLT/AMP	LM315BB:	12.8VDC	- .007A
	LM835CB:	12.8VDC	- .087A
WT/DIMS	LM315BB:	.187 lb. / 2.25" x 2.25" x 1.625"	
	LM835CB:	.210 lb. / 3.75" x 3.75" x 0.75"	
WARRANTY	Lifetime LED Warranty		



LM315BB



LM835CB

UCL07 SERIES

Silicone LED Rope Light

- Lumen rating: 1800 lm
- Sonically sealed, waterproof
- Flexible silicone design
- Surface adhesive mount
- Hard wired
- IP66 rating

BULK P/N	POLYPACK P/N	DESCRIPTION	QTY
STRIP LIGHT - 76 COB			
UCL07CB	UCL07CBP	Rope light, silicone color	1

MATERIALS	Polycarbonate lens and housing		
VOLT/AMP	12.8VDC - .892A		
WT/DIMS	33"		
WARRANTY	Lifetime LED Warranty		



UC07CB



UCL09 SERIES 3" Sealed LED Utility/Hitch Light for Surface Mount

- Designed to illuminate hitch area of trailer
- Sonically sealed, waterproof
- Flange surface mount – no panel cutout required
- Design includes both lead and ground wire



UCL09CB



UCL09CBB



UCL09RCB

BULK P/N	POLYPACK P/N	DESCRIPTION	QTY
WHITE UTILITY LIGHT - 9 DIODES			
UCL09CB	UCL09CBP	Utility light, 9 white LEDs	50
BLUE UTILITY LIGHT - 9 DIODES			
UCL09CBB	UCL09CBBP	Utility light, 6 white, 3 blue LEDs, 3-wire	50
RED UTILITY LIGHT - 9 DIODES			
UCL09RCB	UCL09RCBP	Utility light, 9 red LEDs	50
ACCESSORIES			
A09BB	A09BBP	Black snap-on trim ring	50
A09CB	A09CBP	Chrome snap-on trim ring	50
A09WB	A09WBP	White snap-on trim ring	50
A09GB	A09GBP	Black gasket	50

MATERIALS	Polycarbonate lens and housing
VOLT/AMP	UCL09CB: 12.8VDC - 0.074A UCL09CBB: 12.8VDC - 0.114A
WT/DIMS	.265 lb. / 3.25" x 3.25" x .813"
WARRANTY	Lifetime LED Warranty

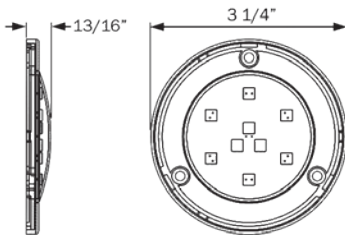

UCL10 SERIES 3/4" Sealed LED Utility Light

- Sealed, waterproof
- Compact – fits 3/4" hole
- Design includes both lead and ground wire

BULK P/N	POLYPACK P/N	DESCRIPTION	QTY
UTILITY LIGHT - 1 DIODE			
UCL10CKB	UCL10CKBP	Clear utility light, A11GB	50
UCL10CK1B	UCL10CK1BP	Clear utility light, A11GB, .156 male bullets	50
BLUE - 1 DIODE			
UCL10BCKB	UCL10BCKBP	Blue utility light, A11GB	20

MATERIALS	Polycarbonate lens and housing
VOLT/AMP	12.8VDC - 0.054A
WT/DIMS	.265 lb. / 0.74" x 0.74" x 0.938"
WARRANTY	Lifetime LED Warranty



UCL10CKB



UCL10BCKB

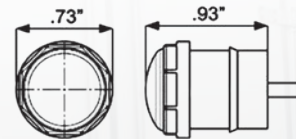

LED INTERIOR/UTILITY LIGHTS



UCL11CKB

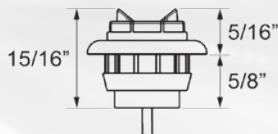
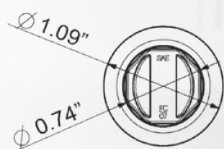

UCL11 SERIES 3/4" Sealed LED Utility Light

- Sealed, waterproof
- Compact – fits 3/4" hole
- Design includes both lead and ground wire

BULK P/N	POLYPACK P/N	DESCRIPTION	QTY
UTILITY LIGHT - 2 DIODES			
UCL11CB	UCL11CBP	Utility light	50
UCL11CKB	UCL11CKBP	Kit: UCL11CB & A11GB grommet	50
UCL11CKPG	UCL11CKPGP	Kit: UCL11CB with .180 male bullets & A14GB grommet	50
ACCESSORIES			
A11GB	A11GBP	Grommet	100
A14GB	A14GBP	Sealing grommet, .125-.250" material	100
A11PB	A11PBP	Snap-in mounting flange	100

MATERIALS Polycarbonate lens and housing
VOLT/AMP 12.8VDC - 0.054A
WT/DIMS .265 lb. / 0.74" x 0.74" x 0.938"
WARRANTY Lifetime LED Warranty



UCL13C2PG



UCL13CB2B

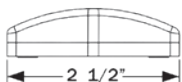
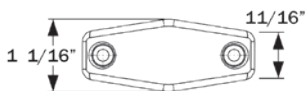

UCL13 SERIES Sealed LED Utility Light

- Sealed, waterproof
- Compact, surface mount design
- Design includes both lead and ground wire

BULK P/N	POLYPACK P/N	DESCRIPTION	QTY
WHITE UTILITY LIGHT - 2 DIODES			
UCL13C2PG	UCL13C2PGP	Utility light, .180 female barrels	20
UCL13CPG	UCL13CPGP	Utility light, .156 male bullets	20
BLUE - 2 DIODES			
UCL13CB2B	UCL13CB2BP	Blue LED utility light	20
ACCESSORIES			
A13C2B	A13C2BP	Chrome base/bezel	100
A13B2B	A13B2BP	Black base/bezel	100
A13G2B	A13G2BP	Gasket	200

MATERIALS Polycarbonate lens and housing
VOLT/AMP 12.8VDC - 0.020A
WT/DIMS .088 lb. / 2.5" x 1.063" x .688"
WARRANTY Lifetime LED Warranty

UCL19 SERIES

Miro-Flex™ Sealed LED Utility Light

- Sealed, waterproof
- Surface mount, mounts on 4-5/8" centers
- Design includes both lead and ground wire

BULK P/N	POLYPACK P/N	DESCRIPTION	QTY
UTILITY LIGHT - 4 DIODES			
UCL19CB	UCL19CBP	Utility light	20
ACCESSORIES			
A19CB	A19CBP	Chrome bezel	100
MATERIALS	Polycarbonate lens and housing		
VOLT/AMP	12.8VDC - 0.051A		
WT/DIMS	.132 lb. / 5.75" x 1.563" x .75"		
WARRANTY	Lifetime LED Warranty		



UCL19CB

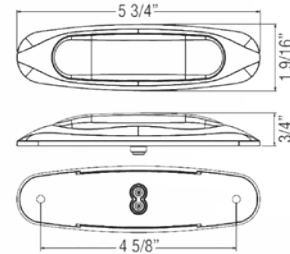

UCL41 SERIES

LED Low Profile Exterior Scene Light

- Sonically sealed, waterproof
- Low profile design with 45-degree downward angle (lens angle at 15 degrees)
- Surface flange mount on 7.875" centers
- Operating voltage 12-24VDC; use with both 12VDC and 24VDC systems
- IP67 Rated
- Hard wired with 6" lead and ground wires

BULK P/N	POLYPACK P/N	DESCRIPTION	QTY
UTILITY LIGHT - 12 DIODES			
UCL41CB	UCL41CBP	Exterior scene light, 12V-24V	10
ACCESSORIES			
A41CBB	A41CBBP	Black plastic bezel	50
A41CRB	A41CRBP	Chrome bezel	50

Raw lumen output: 2400 lm
Effective lumen output: 1200 lm

MATERIALS	Aluminum base, polycarbonate lens
VOLT/AMP	12.8VDC - 2.07A / 24VDC - 0.96A
WT/DIMS	1 lb. / 8.7" x 2.95" x 1.59"
WARRANTY	Lifetime LED Warranty



UCL41CB

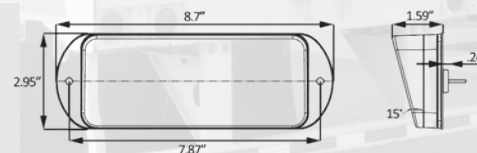



UCL50CB

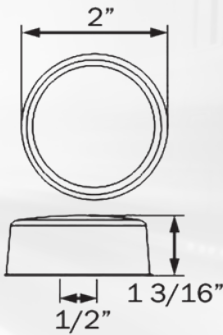

UCL50 SERIES Miro-Flex™ 2" Sealed LED Utility Light

- Miro-Flex™ design with Crystal Clear™ lens
- Operating voltage 12-24VDC
- Sonically sealed, waterproof
- Accepts standard two-pin PL-10 plug

BULK P/N	POLYPACK P/N	DESCRIPTION	QTY
UTILITY LIGHT - 9 DIODES			
UCL50CB	UCL50CBP	12-24VDC Utility light	20
ACCESSORIES			
A46PB	A46PBP	Straight plug, 6" lead	100
A86PB	A86PBP	Straight plug, 18" lead	100
A54GB	A54GBP	2" Flush mount grommet	100
A54GK	A54GKP	2" Kit: A54GB and A46PB	100
A55CB	A55CBP	2" Chrome trim ring	20
BK5557GB	BK5557GBP	Cam-on mounting bracket	50

MATERIALS Polycarbonate lens and housing
VOLT/AMP 12.8VDC - 0.013A
WT/DIMS .088 lb. / 2" x 2" x 1.188"
WARRANTY Lifetime LED Warranty



UCL55CB

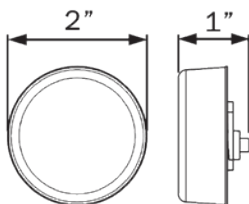

UCL55 SERIES 2" Sealed LED Utility Light

- Sonically sealed, waterproof
- Accepts standard two-pin PL-10 plug

BULK P/N	POLYPACK P/N	DESCRIPTION	QTY
UTILITY LIGHT - 3 DIODES			
UCL55CB	UCL55CBP	Utility light	20
ACCESSORIES			
A46PB	A46PBP	Straight plug, 6" lead	100
A86PB	A86PBP	Straight plug, 18" lead	100
A54GB	A54GBP	2" Flush mount grommet	100
A54GK	A54GKP	2" Kit: A54GB and A46PB	100
A55CB	A55CBP	2" Chrome trim ring	20
BK5557GB	BK5557GBP	Cam-on mounting bracket	50

MATERIALS Polycarbonate lens and housing
VOLT/AMP 12.8VDC - 0.047A
WT/DIMS .088 lb. / 2" x 2" x 1"
WARRANTY Lifetime LED Warranty

UCL59 SERIES

Thinline Sealed LED Utility Light



UCL59CB

- Sonically sealed, waterproof
- Low profile design - less than 1/2" thick
- Surface mount on 11-3/4" centers
- Hard wired with separate ground wire
- Available in bulk and polypack packaging

BULK P/N	POLYPACK P/N	DESCRIPTION	QTY
THINLINE UTILITY LIGHT - 9 DIODES			
UCL59CB	UCL59CBP	Bar style utility light, 2-wire	10

Raw lumen output: 585 lm
Effective lumen output: 386 lm

MATERIALS	Polycarbonate lens and housing
VOLT/AMP	12.8VDC - 0.22A
WT/DIMS	0.2 lbs. / 12.625" x 1" x .41"
WARRANTY	Lifetime LED Warranty

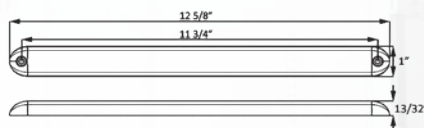



UCL60/160 SERIES Sealed LED Utility Light

- Sealed, waterproof
- Compact, surface mount design
- Design includes both lead and ground wire
- CSA certified for use in sleeping quarters
- Snap-on trim ring included, multiple finishes available



UCL60CB



UCL60CSBB



UCL60CSNB

TOUCH
ON/OFF

BULK P/N	POLYPACK P/N	DESCRIPTION	QTY
TOUCH SWITCH UTILITY LIGHT - 6 DIODES			
UCL60CSBB	UCL60CSBBP	Utility light, black trim ring	20
UCL60CSNB	UCL60CSNBP	Utility light, brushed nickel trim ring	20
UCL60CSWNB	UCL60CSWNBP	Utility light, warm white LED, brushed nickel trim ring	20
UTILITY LIGHT, NO SWITCH - 6 DIODES			
UCL60CB	UCL60CBP	Utility light, chrome trim ring	20
UCL60CBPG	UCL60CBPGP	Utility light, chrome trim ring, .180 female barrels	20

Raw lumen output: 224 lm

Effective lumen output: 168 lm

BULK P/N	POLYPACK P/N	DESCRIPTION	QTY
GLOLIGHT™ UTILITY LIGHT - 6 DIODES			
UCL160CB	UCL160CBP	Utility light, chrome trim ring	20

Raw lumen output: 224 lm

Effective lumen output: 168 lm



PATENTED
TECHNOLOGY



UCL160CB

MATERIALS	Polycarbonate lens and housing
VOLT/AMP	12.8VDC - 0.020A
WT/DIMS	.088 lb. / 3" x 3" x .375"
WARRANTY	Lifetime LED Warranty

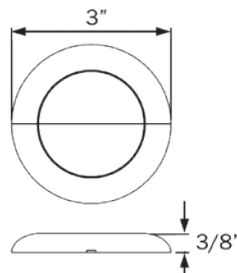

UCL65 SERIES

Sealed LED Thinline Utility Light

- Sealed, waterproof
- Multiple mounting and wiring options available

BULK P/N	POLYPACK P/N	DESCRIPTION	QTY
UTILITY LIGHT - 6 DIODES			
UCL65CB	UCL65CBP	Utility light	20
ACCESSORIES			
A65B	A65BP	Black bracket	50
A65P	A65PP	Single wire plug, .156 male bullet	50
A65PB	A65PBP	Kit: A65B black bracket & A65P plug	50
A66PB	A66PBP	Kit: Gray bracket & A65P plug	50
A67CB	A67CBP	Kit: Chrome bracket & A65P plug	50
A68PB	A68PBP	Kit: Black bracket & 2-wire plug	50

For more details on mounting and wiring accessories, see Accessories section at back of catalog.

MATERIALS	Polycarbonate lens and housing
VOLT/AMP	12.8VDC - 0.048A
WT/DIMS	.066 lb. / 3.875" x 1.25" x 1.125"
WARRANTY	Lifetime LED Warranty



UCL65CB

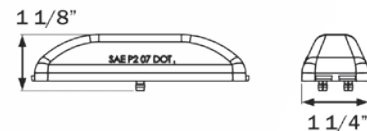
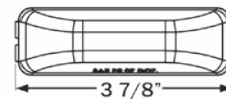

UCL66 SERIES

Sealed LED Surface Mount Utility Light

- Sonically sealed, waterproof
- Surface mount, mounts on 3" centers
- Includes both lead and ground wire

BULK P/N	POLYPACK P/N	DESCRIPTION	QTY
GREEN UTILITY LIGHT - 6 DIODES			
UCL66GB	UCL66GBP	Utility light	20

MATERIALS	Polycarbonate lens and housing
VOLT/AMP	12.8VDC - 0.057A
WT/DIMS	.088 lbs. / 4" x .875" x 1.188"
WARRANTY	Lifetime LED Warranty



UCL66GB

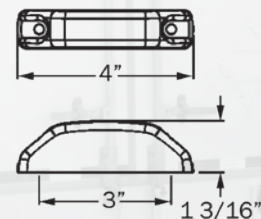



UCL90CB



UCL90BCB

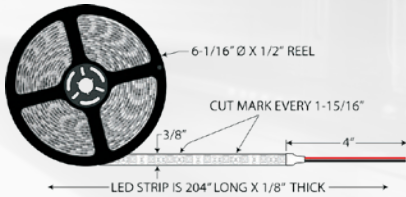

UCL90 SERIES LED Flexible Strip Lighting

- Cut to desired length
- Flexible design fits many applications
- Supplied in 17-ft rolls
- Adhesive mount
- Available with white or blue diodes

BULK P/N	POLYPACK P/N	DESCRIPTION	QTY
WHITE STRIP LIGHT			
UCL90CB	UCL90CBP	17-foot roll	10
BLUE STRIP LIGHT			
UCL90BCB	UCL90BCBP	17-foot roll	10
ACCESSORIES			
A90PB	A90BPB	Snap-on connector, wire leads	20
A90P1B	A90P1BP	Snap-on connector, strip-to-strip	20

MATERIALS	Diodes, copper, polyimide polymer, adhesive
VOLT/AMP	12.8VDC
WT/DIMS	Reel: .39 lbs / 6.10" x 6.10" x 0.48" Strip: .39 lbs / 204" x 0.375" x 0.125"
WARRANTY	Lifetime LED Warranty

UCL91/92 SERIES LED Flexible Strip Lighting

- Cut to desired length
- Flexible design fits many applications
- Kits include strip light and two each snap-on connectors A90PB and A90P1B
- Supplied in rolls (17ft and 5ft)
- 3M adhesive backing
- IP65 rated for dust and water resistance
- Available with white or blue diodes
- Supplied in color retail boxes

BULK P/N	POLYPACK P/N	DESCRIPTION	QTY
WHITE STRIP LIGHT			
UCL91CB	-	17-foot roll, color box	10
UCL92CB	-	5-foot roll, color box	10
UCL91CKB	-	Kit: 17-foot roll, color box	10
UCL92CKB	-	Kit: 5-foot roll, color box	10
BLUE STRIP LIGHT			
UCL91BCB	-	17-foot roll, color box	10
UCL92BCB	-	5-foot roll, color box	10
UCL91BCKB	-	Kit: 17-foot roll, color box	10
UCL92BCKB	-	Kit: 5-foot roll, color box	10
ACCESSORIES			
A90PB	A90PBP	Snap-on connector, wire leads	20
A90P1B	A90P1BP	Snap-on connector, strip-to-strip	20

MATERIALS	Diodes, copper, polyimide polymer, adhesive
VOLT/AMP	12.8VDC
WT/DIMS	.39 lbs / Reel: 6.10" x 6.10" x 0.48" Strip: 204" x 0.375" x 0.125"
WARRANTY	Lifetime LED Warranty



UCL91CB



UCL91BCB



UCL92CB



UCL92BCB

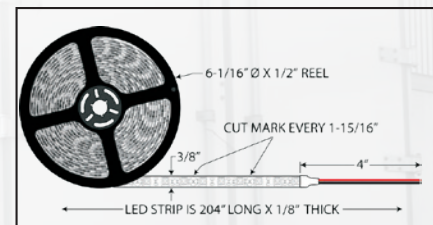



UCL178 SERIES GloLight® 6" Oval Sealed LED Utility Lights for Surface Mount



Tail and Utility



Unlit



UCL178RFP2B Auxiliary

- LED utility light with built-in auxiliary tail light
- Sonically sealed, waterproof
- Surface flange mount – no panel cutout required
- Design includes both lead and ground wire

BULK P/N	POLYPACK P/N	DESCRIPTION	QTY
UTILITY LIGHT - 22 DIODES			
UCL178RFP2B	UCL178RFP2BP	Hard wired, female PL-3 connector	10
ACCESSORIES			
A78CB1	A78CB1P	Chrome flange cover	25
A78RXB	A78RXBP	Red reflex flange cover & gasket	25
A7TRSSB	A7TRSSBP	Stainless steel trim ring	100

MATERIALS	Polycarbonate lens and housing
VOLT/AMP	12.8VDC - 0.50A
WT/DIMS	.265 lbs. / 7.5" x 3.25" x 1.25"
WARRANTY	Lifetime LED Warranty

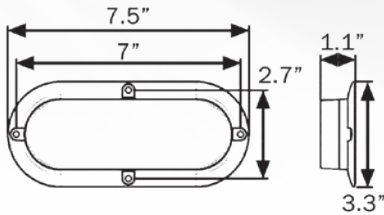

UCL299 SERIES

Utility Light

- Sonically sealed, waterproof
- Adhesive mount
- Hard wired, includes separate ground wire
- Available in bulk and polypack packaging



UCL299CPG

BULK P/N	POLYPACK P/N	DESCRIPTION	QTY
UTILITY LIGHT - 1 DIODE			
UCL299CPG	UCL299CPGP	Clear utility light, .180 male bullets	50

MATERIALS	Polycarbonate lens and housing
VOLT/AMP	12.8VDC - .12A
WT/DIMS	.046 lb. / 1.53" x .73" x .5"
WARRANTY	Lifetime LED Warranty

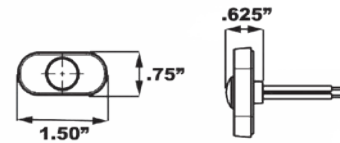

ULL25 SERIES

COB LED Utility Strip Light

- Waterproof
- Slim design - only 5/8" wide and 3/16" thick
- Design includes both lead and ground wire
- Ultrawhite – color temperature 6500K



ULL25CTB

BULK P/N	POLYPACK P/N	DESCRIPTION	QTY
STRIP LIGHT - 76 COB			
ULL25CTVRB	ULL25CTVRBP	12V strip light, voltage regulator	50
ULL25CTB	ULL25CTBP	12V strip light	50
Raw lumen output: 380 lm			
Effective lumen output: 220 lm			

MATERIALS	Polycarbonate lens and housing
VOLT/AMP	12.8VDC - .3A
WT/DIMS	.25 lb. / 6.829" x .616" x 0.14"
WARRANTY	Lifetime LED Warranty

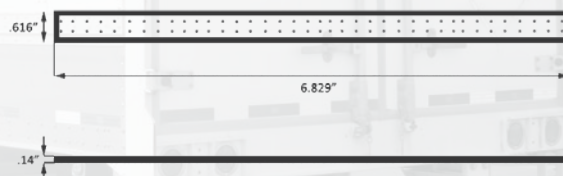



ULL69APG Thinline Sealed LED Utility Light



ULL69APG

- Sonically sealed, waterproof
- Low profile design—only 5/8" thick
- Surface mount on 14-1/8" centers; optional gasket
- Three-wire design - low and bright functions
- Hard wired with separate ground wire

BULK P/N	POLYPACK P/N	DESCRIPTION	QTY
YELLOW - 11 DIODE			
ULL69APG	ULL69APGP	Bar style utility light, 2-wire	10
ACCESSORIES			
A69CB	A69CBP	Chrome base/bezel	10
A69GB	A69GBP	Gasket	50

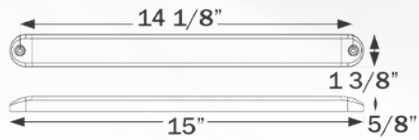

MATERIALS	Polycarbonate lens and housing
VOLT/AMP	12.8V - 0.28A/0.01A
WT/DIMS	.441 lbs. / 15" x 1.375" x .625"
WARRANTY	Lifetime LED Warranty

TLL149 SERIES Opti-Brite™ LED Work Light

- Heavy duty design with powder coated, die cast aluminum housing and polycarbonate lens
- Dual power: use with 12VDC and 24VDC systems
- Stainless steel mounting hardware

BULK P/N	POLYPACK P/N	DESCRIPTION	QTY
FLOOD BEAM - 10 DIODES			
TLL149FB	TLL149FBP	Flood beam	1

Raw lumen output: 2400 lm
Effective lumen output: 1680 lm

MATERIALS	Polycarbonate lens, aluminum housing
VOLT/AMP	13.5V at 2.05A±0.18A, 28V at 0.97A±0.08A
WT/DIMS	0.95 lbs. / 6.625" x 3.5" x 2.665"
WARRANTY	Lifetime LED Warranty

IP69K RATING

Highest designation available for water ingress testing, offering increased reliability and service life when subjected to severe environmental conditions or cleaning methods.

Opti-Brite



TLL149FB

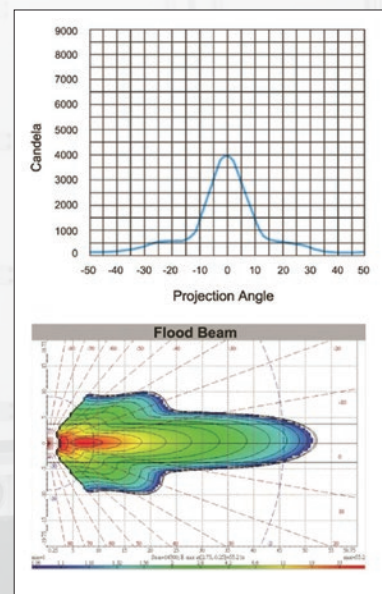
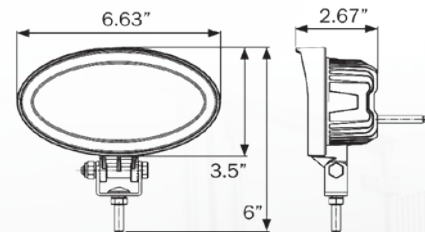



TLL30 SERIES Opti-Brite™ LED Work Light



TLL30FB

- Compact design – only 3.25" diameter
- Die cast aluminum housing with powder coat finish
- Stainless steel hardware
- 16-gauge, 20" lead and ground wire; IP69K rating

BULK P/N	POLYPACK P/N	DESCRIPTION	QTY
FLOOD BEAM - 4 DIODES			
TLL30FB	TLL30FBP	Flood beam	1t

Raw lumen output: 960 lm
Effective lumen output: 670 lm

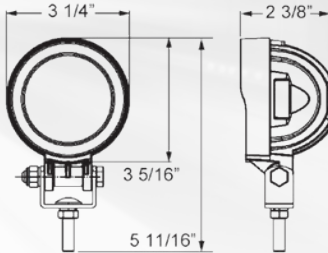

MATERIALS	Polycarbonate lens, aluminum housing
VOLT/AMP	12.8VDC - 0.75A, 24.0VDC - 0.37A
WT/DIMS	1.468 lbs. / 3.27" x 5.70" x 2.36"
WARRANTY	Lifetime LED Warranty

IP69K RATING

Highest designation available for water ingress testing, offering increased reliability and service life when subjected to severe environmental conditions or cleaning methods.

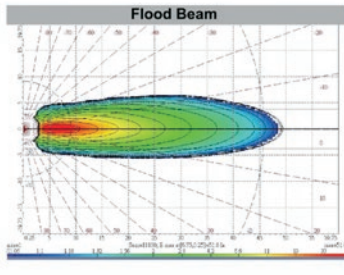
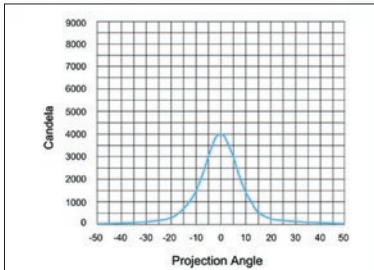

TLL44/45 SERIES Opti-Brite™ LED Work Lights

- Heavy duty design with powder coated, die cast aluminum housing and polycarbonate lens
- Low profile design – only 2 inches deep
- Dual power: use with 12VDC and 24VDC systems
- Stainless steel mounting hardware
- 14-gauge, 10" lead and ground wire

BULK P/N	POLYPACK P/N	DESCRIPTION	QTY
ROUND LED WORK LIGHT - 6 DIODES			
TLL44FB	TLL44FBP	Flood beam	2
RETAIL			
TLL144FSL		Flood beam, window box	3
Raw lumen output: 1200 lm Effective lumen output: 720 lm			
MATERIALS	Polycarbonate lens, aluminum housing		
VOLT/AMP	12.8VDC - 1.1A, 24.0VDC - 0.48A		
WT/DIMS	0.98 lbs. / 4" x 6.281" x 2.375"		
WARRANTY	Lifetime LED Warranty		

BULK P/N	POLYPACK P/N	DESCRIPTION	QTY
ROUND LED WORK LIGHT - 8 DIODES			
TLL45FB	TLL45FBP	Flood beam	3
Raw lumen output: 1600 lm Effective lumen output: 897 lm			
MATERIALS	Polycarbonate lens, aluminum housing		
VOLT/AMP	12.8VDC - 1.38A, 24.0VDC - 0.65A		
WT/DIMS	1.389 lbs. / 4.5" x 7" x 2"		
WARRANTY	Lifetime LED Warranty		



TLL144FSL



TLL44FB

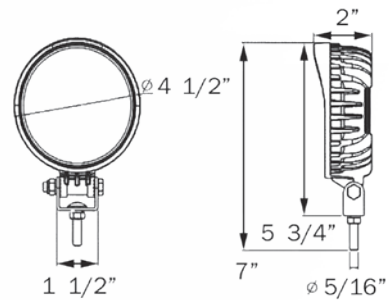

TLL45FB

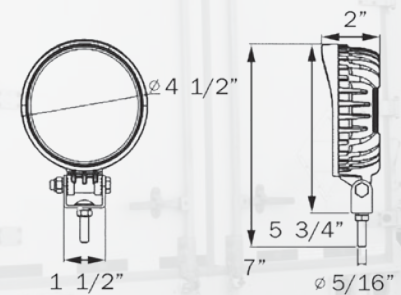



TLL46 SERIES Opti-Brite™ LED Work Lights

- Heavy duty design with powder coated, die cast aluminum housing and polycarbonate lens
- Low profile design – less than 2.5 inches deep
- Dual power: use with 12VDC and 24VDC systems
- Stainless steel mounting hardware
- 14-gauge, 10" lead and ground wire



TLL46CFB



TLL46TB



BULK P/N	POLYPACK P/N	DESCRIPTION	QTY
----------	--------------	-------------	-----

FLOOD BEAM - 9 DIODES

TLL46CFB	TLL46CFBP	Flood beam	3
----------	-----------	------------	---

Raw lumen output: 2160 lm

Effective lumen output: 1492 lm

MATERIALS	Polycarbonate lens, aluminum housing
VOLT/AMP	12.8VDC - 1.70A, 24.0VDC - 1.0A
WT/DIMS	1.764 lbs. / 5" x 7" x 2.375"
WARRANTY	Lifetime LED Warranty

BULK P/N	POLYPACK P/N	DESCRIPTION	QTY
----------	--------------	-------------	-----

TRAPEZOID BEAM - 9 DIODES

TLL46TB	TLL46TBP	Trapezoid beam	3
---------	----------	----------------	---

Raw lumen output: 1800 lm

Effective lumen output: 707 lm

MATERIALS	Polycarbonate lens, aluminum housing
VOLT/AMP	12.8VDC - 1.50A, 24.0VDC - 0.73A
WT/DIMS	1.764 lbs. / 5" x 7" x 2.375"
WARRANTY	Lifetime LED Warranty

IP69K RATING

Highest designation available for water ingress testing, offering increased reliability and service life when subjected to severe environmental conditions or cleaning methods.

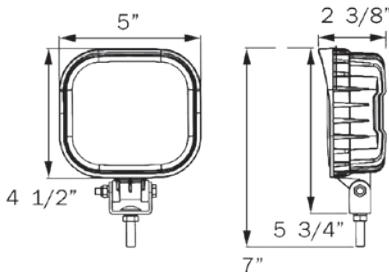

TLL48 SERIES Opti-Brite™ LED Work Light

- Heavy duty design with powder coated, die cast aluminum housing and polycarbonate lens
- Low profile design – less than 2.5 inches deep
- Dual power: use with 12VDC and 24VDC systems
- Stainless steel mounting hardware
- 14-gauge, 10" lead and ground wire; IP69K rating

BULK P/N	POLYPACK P/N	DESCRIPTION	QTY
FLOOD BEAM - 6 DIODES			
TLL48FB	TLL48FBP	Flood beam	5
Raw lumen output: 1200 lm Effective lumen output: 617 lm			
MATERIALS	Polycarbonate lens, aluminum housing		
VOLT/AMP	12.8VDC - 1.52A, 24.0VDC - 0.65A		
WT/DIMS	1.14 lbs. / 4.15" x 6.375" x 2.14"		
WARRANTY	Lifetime LED Warranty		

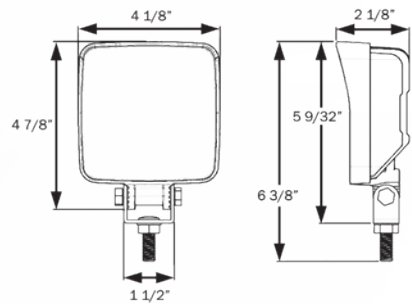

TLL50 SERIES Opti-Brite™ LED Work Light

- Lightweight, compact LED work light
- Corrosion proof housing and polycarbonate lens
- Dual power: use with 12VDC and 24VDC systems
- 22-gauge, 10" lead and ground wire
- IP69K rating

BULK P/N	POLYPACK P/N	DESCRIPTION	QTY
FLOOD BEAM - 9 DIODES			
TLL50FB	TLL50FBP	Flood beam	3
RETAIL			
TLL150FSL		Flood beam, window box	3
Raw lumen output: 324 lm Effective lumen output: 252 lm			

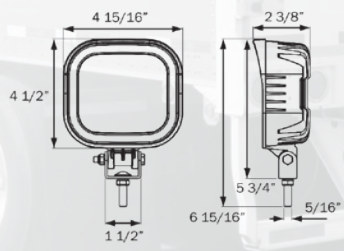

MATERIALS	Polycarbonate lens and housing, stainless steel hardware
VOLT/AMP	12.8VDC - 1.50A, 24.0VDC - 0.73A
WT/DIMS	1 lbs. / 4.938" x 6.938" x 2.375"
WARRANTY	Lifetime LED Warranty





TLL51FB

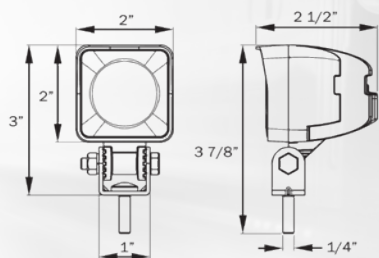

TLL51 SERIES

Opti-Brite™ LED Work Light

- Heavy duty design with powder coated, die cast aluminum housing and polycarbonate lens
- Compact design – only 2 inches square
- Dual power: use with 12VDC and 24VDC systems
- Stainless steel mounting hardware
- 14-gauge, 10" lead and ground wire; IP69K rating

BULK P/N	POLYPACK P/N	DESCRIPTION	QTY
----------	--------------	-------------	-----

FLOOD BEAM - 1 DIODE

TLL51FB	TLL51FBP	Flood beam	10
TLL51FRPG	TLL51FRPGP	Flood beam, .180 male bullet on power, ring terminal on ground	10

Raw lumen output: 800 lm

Effective lumen output: 549 lm

MATERIALS	Polycarbonate lens, aluminum housing
VOLT/AMP	12.8VDC - 0.91A, 24.0VDC - 0.42A
WT/DIMS	0.37 lbs. / 2" x 3" x 2.5"
WARRANTY	Lifetime LED Warranty



TLL52FWB

TLL52FB



TLL52FSL

TLL52 SERIES

Opti-Brite™ LED Work Light

- Heavy duty design with powder coated, die cast aluminum housing and polycarbonate lens
- Compact design – only 2.75 inches square
- Dual power: use with 12VDC and 24VDC systems
- Stainless steel mounting hardware
- 14-gauge, 10" lead and ground wire; IP69K rating

BULK P/N	POLYPACK P/N	DESCRIPTION	QTY
----------	--------------	-------------	-----

FLOOD BEAM - 3 DIODES

TLL52FB	TLL52FBP	Flood beam, black housing	10
TLL52FWB	TLL52FWBP	Flood beam, white housing	10

RETAIL

TLL52FSL		Flood beam, window box	3
----------	---	------------------------	---

Raw lumen output: 600 lm

Effective lumen output: 325 lm

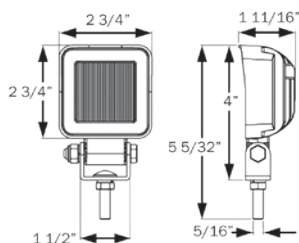

MATERIALS	Polycarbonate lens and housing, stainless steel hardware
VOLT/AMP	12.8VDC - 1.50A, 24.0VDC - 0.73A
WT/DIMS	.38 lbs. / 2.75" x 5.171" x 1.687"
WARRANTY	Lifetime LED Warranty

TLL54 SERIES

Opti-Brite™ LED Work Light

- Heavy duty design with powder coated, die cast aluminum housing and polycarbonate lens
- Low profile design – less than 2.5 inches deep
- Dual power: use with 12VDC and 24VDC systems
- Stainless steel mounting hardware
- 14-gauge, 10" lead and ground wire; IP69K rating

BULK P/N	POLYPACK P/N	DESCRIPTION	QTY
SPOT BEAM - 9 DIODES			
TLL54TB	TLL54TBP	Spot beam	5
Raw lumen output: 1800 lm			
Effective lumen output: 900 lm			

MATERIALS	Polycarbonate lens, aluminum housing
VOLT/AMP	12.8VDC - 1.50A, 24.0VDC - 0.73A
WT/DIMS	1.51 lbs. / 5" x 7" x 2.375"
WARRANTY	Lifetime LED Warranty

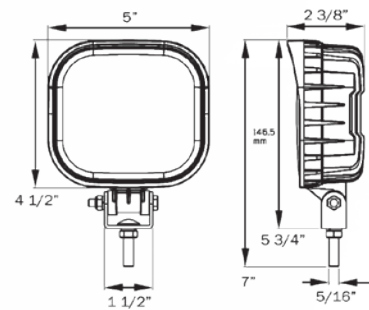

TLL55 SERIES

Opti-Brite™ LED Work Light



- Contoured lens for wide angle beam
- Die cast aluminum housing with powder coat finish
- Stainless steel hardware
- 14-gauge, 10" lead and ground wire; IP69K rating

BULK P/N	POLYPACK P/N	DESCRIPTION	QTY
FLOOD BEAM - 9 DIODES			
TLL55FB	TLL55FBP	Flood beam	1
Raw lumen output: 2160 lm			
Effective lumen output: 1512 lm			

MATERIALS	Polycarbonate lens, aluminum housing
VOLT/AMP	12.8VDC - 1.50A, 24.0VDC - 0.73A
WT/DIMS	1.35 lbs. / 4.87" x 6.90" x 2.03"
WARRANTY	Lifetime LED Warranty

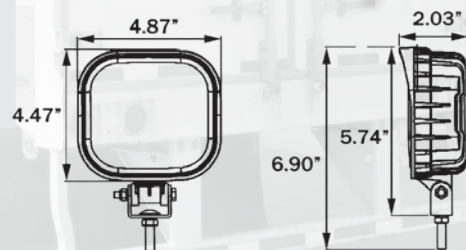



TLL56FB

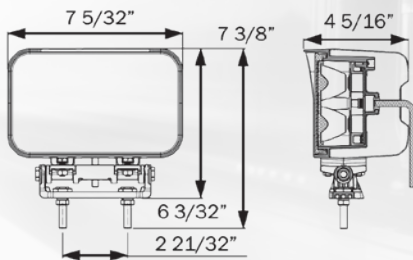

TLL56/57 SERIES Opti-Brite™ LED Work Lights

- Heavy duty design with powder coated, die cast aluminum housing and polycarbonate lens
- Dual power: use with 12VDC and 24VDC systems
- Stainless steel mounting hardware
- 16-gauge, 20" lead and ground wire; IP69K rating

BULK P/N	POLYPACK P/N	DESCRIPTION	QTY
FLOOD BEAM - 8 DIODES			
TLL56FB	TLL56FBP	Flood beam	2
TLL57FB	TLL57FBP	Flood beam, shock mount	2
Raw lumen output: 4000 lm			
Effective lumen output: 2800 lm			

MATERIALS	Polycarbonate lens, aluminum housing
VOLT/AMP	12.8VDC - 5.0A, 24.0VDC - 2.5A
WT/DIMS	3.53 lbs. / 7.161" x 9" x 4.313"
WARRANTY	Lifetime LED Warranty



TLL60FB

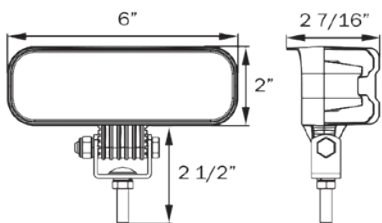

TLL60 SERIES Opti-Brite™ LED Work Light

- Heavy duty design with powder coated, die cast aluminum housing and polycarbonate lens
- Rectangular design – 6 inches wide by 2 inches high
- Dual power: use with 12VDC and 24VDC systems
- Stainless steel mounting hardware
- 14-gauge, 10" lead and ground wire; IP69K rating

BULK P/N	POLYPACK P/N	DESCRIPTION	QTY
FLOOD BEAM - 6 DIODES			
TLL60FB	TLL60FBP	Flood beam	5
Raw lumen output: 1200 lm			
Effective lumen output: 720 lm			

MATERIALS	Polycarbonate lens, aluminum housing
VOLT/AMP	12.8VDC - 1.1A, 24.0VDC - 0.48A
WT/DIMS	0.95 lbs. / 6" x 4.5" x 2.4"
WARRANTY	Lifetime LED Warranty

TLL64 SERIES

Opti-Brite™ LED Work Light

- Heavy duty design with powder coated, die cast aluminum housing and polycarbonate lens
- Ultrabright output in standard size light – 2240 lumens
- Dual power: use with 12VDC and 24VDC systems
- Stainless steel mounting hardware
- 14-gauge, 10" lead and ground wire; IP69K rating

BULK P/N	POLYPACK P/N	DESCRIPTION	QTY
FLOOD BEAM - 4 DIODES			
TLL64FB	TLL64FBP	Flood beam	2
Raw lumen output: 3200 lm Effective lumen output: 2240 lm			
MATERIALS	Polycarbonate lens, aluminum housing		
VOLT/AMP	12.8VDC - 3.16A, 24.0VDC - 1.41A		
WT/DIMS	1.41 lbs. / 4.187" x 6.5" x 3"		
WARRANTY	Lifetime LED Warranty		



TLL64FB

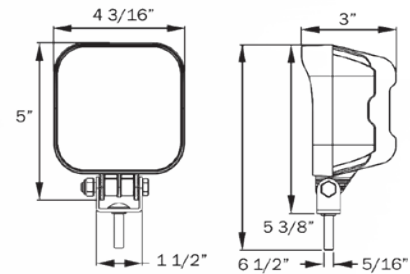

TLL70 SERIES

Opti-Brite™ LED Work Light



- Contoured lens for wide angle beam
- Heavy duty design with powder coated, die cast aluminum housing and polycarbonate lens
- Ultrabright output in standard size light – 3360 lumens
- Dual power: use with 12VDC and 24VDC systems
- Stainless steel mounting hardware
- 14-gauge, 10" lead and ground wire; IP69K rating

BULK P/N	POLYPACK P/N	DESCRIPTION	QTY
FLOOD BEAM - 6 DIODES			
TLL70FB	TLL70FBP	Flood beam	2
Raw lumen output: 4800 lm Effective lumen output: 3360 lm			
MATERIALS	Polycarbonate lens, aluminum housing		
VOLT/AMP	12.8VDC - 2.8A, 24.0VDC - 1.43A		
WT/DIMS	1.41 lbs. / 5" x 4.375" x 2.625"		
WARRANTY	Lifetime LED Warranty		



TLL70FB

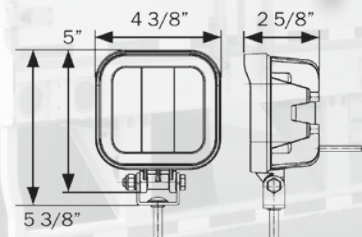



TLL71 SERIES Opti-Brite™ LED Work Light



TLL71FB

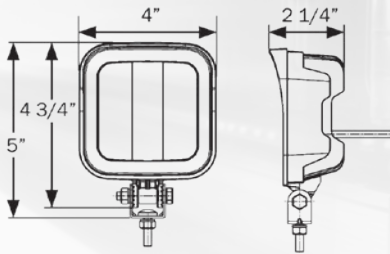

- Contoured lens for wide angle beam
- Heavy duty design with powder coated, die cast aluminum housing and polycarbonate lens
- Dual power: use with 12VDC and 24VDC systems
- Stainless steel mounting hardware
- 14-gauge, 10" lead and ground wire; IP69K rating

BULK P/N	POLYPACK P/N	DESCRIPTION	QTY
FLOOD BEAM - 9 DIODES			
TLL71FB	TLL71FBP	Flood beam	2
Raw lumen output: 2160 lm			
Effective lumen output: 1492 lm			

MATERIALS	Polycarbonate lens, aluminum housing
VOLT/AMP	12.8VDC - 1.43A, 24.0VDC - 0.66A
WT/DIMS	1.41 lbs / 4" x 5" x 2.25"
WARRANTY	Lifetime LED Warranty



TLL72 SERIES Opti-Brite™ LED Work Light



TLL72FB

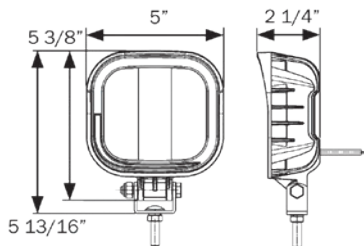

- Contoured lens for wide angle beam
- Heavy duty design with powder coated, die cast aluminum housing and polycarbonate lens
- Dual power: use with 12VDC and 24VDC systems
- Stainless steel mounting hardware
- 14-gauge, 10" lead and ground wire; IP69K rating

BULK P/N	POLYPACK P/N	DESCRIPTION	QTY
FLOOD BEAM - 9 DIODES			
TLL72FB	TLL72FBP	Flood beam	2
Raw lumen output: 2160 lm			
Effective lumen output: 1492 lm			

MATERIALS	Polycarbonate lens, aluminum housing
VOLT/AMP	12.8VDC - 1.48A, 24.0VDC - 0.7A
WT/DIMS	1.5 lbs / 5" x 5.375" x 2.25"
WARRANTY	Lifetime LED Warranty

TLL73 SERIES Opti-Brite™ LED Work Light

- Heavy duty design with powder coated, die cast aluminum housing and polycarbonate lens
- Dual power: use with 12VDC and 24VDC systems
- Stainless steel mounting hardware; built in handle
- 14-gauge, 10" lead and ground wire; IP69K rating

BULK P/N	POLYPACK P/N	DESCRIPTION	QTY
FLOOD BEAM - 9 DIODES			
TLL73FB	TLL73FBP	Flood beam	3
Raw lumen output: 2160 lm			
Effective lumen output: 1492 lm			

MATERIALS	Polycarbonate lens, aluminum housing
VOLT/AMP	12.8VDC - 1.48A, 24.0VDC - 0.7A
WT/DIMS	1.61 lbs / 5" x 7.5" x 3.25"
WARRANTY	Lifetime LED Warranty

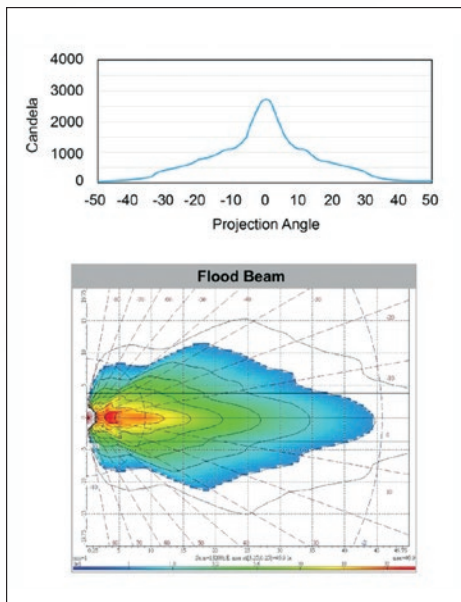

Opti-Brite



TLL73FB

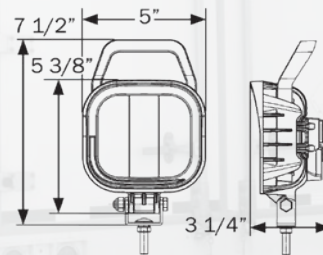



TLL80 SERIES Opti-Brite™ LED Mini Flood Light



TLL80FB

- Coated die cast aluminum housing, polycarbonate lens
- Compact design – only 3 inches wide by 2 inches high
- Bright white SMD diodes for bright, dependable light

BULK P/N	POLYPACK P/N	DESCRIPTION	QTY
FLOOD BEAM - 6 DIODES			

TLL80FB	TLL80FBP	Flood beam, black housing	5
---------	----------	---------------------------	---

Raw lumen output: 270 lm
Effective lumen output: 150 lm

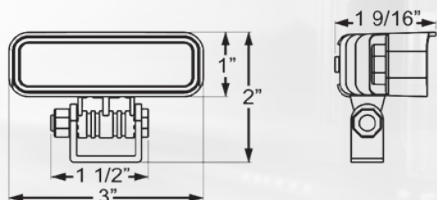

MATERIALS	Polycarbonate lens, aluminum housing
VOLT/AMP	12.8VDC - .19A
WT/DIMS	.7 lbs. / 3" x 2" x 1.563"
WARRANTY	Lifetime LED Warranty



DLL25/50 SERIES LED Docking/Utility Lights



DLL50CB

- Wide, low beam ideal for docking or loading applications
- Die cast aluminum housing coated for protection against corrosion and UV exposure; durable polycarbonate lens
- Sealed lens, gasket at wire entry; IP44 rating
- Dual power: use with 12VDC and 24VDC systems
- Stainless steel mounting hardware
- 20-gauge lead and ground wire with tinned ends

BULK P/N	POLYPACK P/N	DESCRIPTION	QTY
DOCKING/UTILITY LIGHTS - 2 DIODES			

DLL50CB	DLL50CBP	Black housing	10
---------	----------	---------------	----

RETAIL

TLL25FS		Black housing, clam	3
DLL50CC		Pair of lights, black housing, box	3

Raw lumen output: 440 lm
Effective lumen output: 396 lm

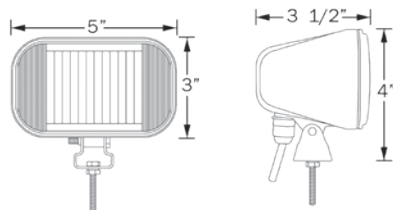

MATERIALS	Polycarbonate lens, aluminum housing
VOLT/AMP	12.8/24.0VDC - 0.683A
WT/DIMS	DLL50CB: 1.23 lbs. / 5" x 4" x 3.5" DLL50CC: 3.00 lbs. / 5" x 4" x 3.5"
WARRANTY	Lifetime LED Warranty

UCL20 SERIES 22" LED Spot/Flood Light Bar



- Heavy duty aluminum housing and polycarbonate lens
- Dual power: use with 12VDC and 24VDC systems
- IP65 rated for dust and water resistance
- Hard wired
- Supplied in color retail window box



UCL20CB



BK20BB

BULK P/N	POLYPACK P/N	DESCRIPTION	QTY
FLOOD BEAM - 40 DIODES			
UCL20CB	-	Spot/flood beam	1
ACCESSORIES			
BK20BB	-	Mounting bracket kit	20
Raw lumen output: 7500 lm			
Effective lumen output: 4521 lm			
MATERIALS	Die Cast Aluminum with Powder Coat Finish Housing and Polycarbonate Lens		
VOLT/AMP	12.8VDC - 6.8A / 24VDC - 3.1A		
WT/DIMS	4.8 lbs / 21.26" x 3.07" x 3.39"		
WARRANTY	Lifetime LED Warranty		



UCL21 SERIES 13" LED Spot/Flood Light Bar



UCL21CB



- Heavy duty aluminum housing and polycarbonate lens
- Dual power: use with 12VDC and 24VDC systems
- IP65 rated for dust and water resistance
- Hard wired
- Supplied in color retail window box



BK20BB

BULK P/N	POLYPACK P/N	DESCRIPTION	QTY
FLOOD BEAM - 24 DIODES			
UCL21CB	-	Spot/flood beam	1
ACCESSORIES			
BK20BB	-	Mounting bracket kit	20
Raw lumen output: 3700 lm			
Effective lumen output: 2717 lm			

MATERIALS	Die Cast Aluminum with Powder Coat Finish Housing and Polycarbonate Lens
VOLT/AMP	12.8VDC - 4A / 24VDC - 1.8A
WT/DIMS	3.19 lbs / 13.58" x 3.15" x 3.46"
WARRANTY	Lifetime LED Warranty

UCL22 SERIES 33" LED Spot/Flood Light Bar



UCL22CB

- Heavy duty aluminum housing and polycarbonate lens
- Dual power: use with 12VDC and 24VDC systems
- IP65 rated for dust and water resistance
- Hard wired
- Supplied in color retail window box



BULK P/N	POLYPACK P/N	DESCRIPTION	QTY
FLOOD BEAM - 60 DIODES			
UCL22CB	-	Spot/flood beam	1
ACCESSORIES			
BK20BB	-	Mounting bracket kit	20
Raw lumen output: 12,600 lm Effective lumen output: 6777 lm			



BK20BB

MATERIALS	Die Cast Aluminum with Powder Coat Finish Housing and Polycarbonate Lens
VOLT/AMP	12VDC - 9.8A / 24VDC - 5.7A
WT/DIMS	5.625 lbs / 33" x 3.15" x 3.46"
WARRANTY	Lifetime LED Warranty



UCL23 SERIES 9" LED Spot/Flood Light Bar



UCL23CB

- Heavy duty aluminum housing and polycarbonate lens
- Dual power: use with 12VDC and 24VDC systems
- IP65 rated for dust and water resistance
- Hard wired, 16-in leads
- Supplied in color retail window box



BK20BB

BULK P/N	POLYPACK P/N	DESCRIPTION	QTY
FLOOD BEAM - 12 DIODES			
UCL23CB	-	Spot/flood beam	1
ACCESSORIES			
BK20BB	-	Mounting bracket kit	20
Raw lumen output: 2520 lm			
Effective lumen output: 1550 lm			
MATERIALS	Die Cast Aluminum with Powder Coat Finish Housing and Polycarbonate Lens		
VOLT/AMP	12.8VDC - 3A / 24VDC - 1.5A		
WT/DIMS	2.4 lbs / 7.25" x 3" x 3.5"		
WARRANTY	Lifetime LED Warranty		

UCL24 SERIES 3" LED Flood Lights

- 3" cube design fits many applications
- Post mount and recess flange mount models available
- Heavy duty aluminum housing and impact resistant polycarbonate lens
- IP65 rated for dust and water resistance
- Hard wired, 16" leads
- Packaged in full color retail box

BULK P/N	POLYPACK P/N	DESCRIPTION	QTY
FLOOD BEAM - 6 DIODES			
UCL24CB	-	Flood beam, post mount	1
UCL24CFB	-	Flood beam, flange mount	1
Raw lumen output: 1800 lm			
Effective lumen output: 780 lm			

MATERIALS	Die Cast Aluminum with Powder Coat Finish Housing and Polycarbonate Lens
VOLT/AMP	12.8VDC - 1.4A
WT/DIMS	Post: 1.2 lbs 3.25" x 3" x 2.75" Recess Flange: 1.2 lb / 4.25" x 3.625" x 2.75"
WARRANTY	Lifetime LED Warranty



UCL24CB



UCL24CFB



UCL24CB



UCL24CFB



LED WORK/OFF-ROAD LIGHTS



UCL25 SERIES 50" LED Spot/Flood Light Bar



UCL25CB



- Heavy duty aluminum housing and polycarbonate lens
- Dual power - use with 12VDC and 24VDC systems
- IP65 rated for dust and water resistance
- Hard wired
- Supplied in color retail window box

BULK P/N	POLYPACK P/N	DESCRIPTION	QTY
FLOOD BEAM - 96 DIODES			
UCL25CB	-	Spot/flood beam	1
ACCESSORIES			
BK20BB	-	Mounting bracket kit	20
Raw lumen output: 20,000 lm			
Effective lumen output: 11,600 lm			



BK20BB

MATERIALS	Die Cast Aluminum with Powder Coat Finish Housing and Polycarbonate Lens
VOLT/AMP	12.8VDC - 22.9A / 24VDC - 11.9A
WT/DIMS	8.1 lbs. / 50" x 3" x 3.5"
WARRANTY	Lifetime LED Warranty

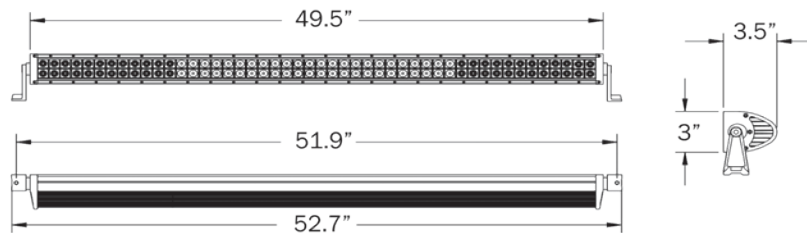

UCL32 SERIES 30" LED Light Bar with Supplemental Turn Function



UCL32CDTB



- Central white LEDs produce bright flood beam, red LEDs on left and right ends provide supplemental turn function (rear facing)
- White LEDs emit 6000K daylight white beam
- Dual power: use with 12VDC and 24VDC systems
- Heavy duty aluminum housing and polycarbonate lens
- Adjustable, sliding brackets for mounting versatility
- IP65 rated for dust and water resistance
- Hard wired with 24-in. leads (4-wire)
- Stainless steel mounting hardware



BK21BB

BULK P/N	DESCRIPTION	QTY
FLOOD BEAM - 96 DIODES		
UCL32CDTB	White flood beam, red supplemental turn	1
ACCESSORIES		
BK21BB	Mounting bracket kit	3
Raw lumen output: 7200 lm		
Effective lumen output: 4000 lm		

MATERIALS	Die Cast Aluminum with Powder Coat Finish Housing and Polycarbonate Lens
VOLT/AMP	12.8VDC - 6.8A / 24VDC - 3.1A
WT/DIMS	4.8 lbs / 29.6" x 2.3" x 2.875"
WARRANTY	Lifetime LED Warranty



ST45 SERIES 4" Round Sealed Lights

- Sonically sealed, waterproof
- Shock-proof socket guarantees long bulb life
- Accepts standard PL-3 plug
- Kits include grommet and plug



ST45RB



ST45AB



ST46RB

SEALED STOP/TURN/TAIL & PARKING/TURN SIGNALS

BULK P/N	POLYPACK P/N	DESCRIPTION	QTY
RED STOP/TURN/TAIL LIGHTS			
ST45RB	ST45RBP	Light with PL-3 connection	50
ST44RB	ST44RBP	Kit: ST45RB, A45GB & A45PB	10
ST45RGB	ST45RGBP	Light with male pin connection	50
ST46RB	ST46RBP	Light with reflex lens, PL-3 connection	50
YELLOW PARKING/TURN SIGNALS			
ST45AB	ST45ABP	Light	50
ST44AB	ST44ABP	Kit: ST45AB, A45GB & A45PB	10
ACCESSORIES			
A45GB	A45GBP	Grommet	50
A45PB	A45PBP	Pigtail, 3-wire	100
A47PB	A47PBP	Right angle pigtail, 3-wire	100
BK45BB	BK45BBP	Black steel bracket	10
RETAIL			
ST45RK		Kit: ST45RB, A45GB & A45PB, clam	6
ST45RS		Light only, clam	6



ST45RGB male pin connection detail

FMVSS	ST45RB: S T I P 2 ST45AB: I P P 2 ST46RB: S T I P 2 A
MATERIALS	Polycarbonate lens and housing
VOLT/AMP	12.8VDC - 2.4A Stop/Turn, 0.49A Tail/Parking
WT/DIMS	ST45/46: .221 lbs. / 4.25" x 4.25" x 2.063"
WARRANTY	Three Year Warranty

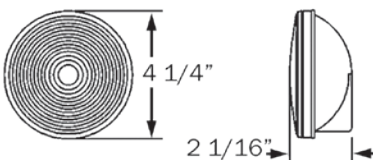

ST45AB/RB & 46RB

HOLE CUT-OUT: 4.5"

ST47 Series 4" Flange Mount Stop/Turn/Tail Light

- Sonically sealed, waterproof
- Shock-proof socket guarantees long bulb life

BULK P/N	POLYPACK P/N	DESCRIPTION	QTY
RED STOP/TURN/TAIL LIGHT			
ST47RB	ST47RBP	Flange mount, PL-3 connection, gray	50
ST47RKB	ST47RKBP	Kit: ST47RB & A45PB	10
ACCESSORIES			
A45PB	A45PBP	Pigtail, 3-wire	100
A47PB	A47PBP	Right angle pigtail, 3-wire	100

FMVSS	S T I P 2
MATERIALS	Polycarbonate lens and housing
VOLT/AMP	12.8VDC - 2.4A Stop/Turn, .49A Tail
WT/DIMS	.617 lbs. / 5.50" x 5.50" x 2"
WARRANTY	Three Year Warranty



ST47RB

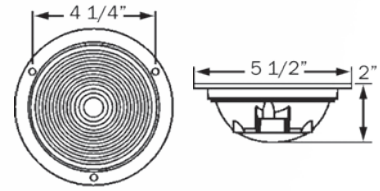

HOLE CUT-OUT: 4.5"

SEALED STOP/TURN/TAIL & PARKING/TURN SIGNALS





ST70/75 SERIES 6" Oval Sealed Lights



ST70RB



ST70RBTK



ST70AB



ST75AB

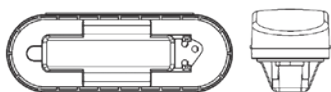
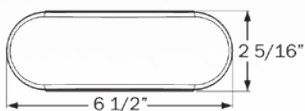

ST70

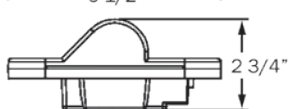
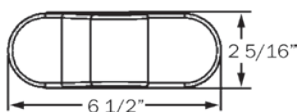

ST75AB

HOLE CUT-OUT: 6.85" X 2.5" (1.25" R)

- Sonically sealed, waterproof
- Shock-proof socket guarantees long bulb life
- Accepts standard PL-3 plug
- Kits include grommet and plug

BULK P/N	POLYPACK P/N	DESCRIPTION	QTY
----------	--------------	-------------	-----

RED STOP/TURN/TAIL LIGHTS

ST70RB	ST70RBP	Light	50
ST74RB	ST74RBP	Kit: ST70RB, A70GB & A45PB	50
ST70RBTK	ST70RBTKP	ST70RB light sealed to bracket	30
ST64RB	ST64RBP	Kit: ST70RB, A70GB & A47PB (plug attached to light)	50
ST65RB	ST65RBP	Kit: ST70RB, A70GB & A47PB	50

YELLOW SIGNAL LIGHTS

ST70AB	ST70ABP	Parking/turn signal	50
ST74AB	ST74ABP	Kit: ST70AB, A70GB & A45PB	50
ST75AB	ST75ABP	Mid-ship turn signal/marker	50
ST77AB	ST77ABP	Kit: ST75AB, A70GB & A45PB	50

ACCESSORIES

A70GB	A70GBP	Grommet	50
A45PB	A45PBP	Pigtail, 3-wire	100
A47PB	A47PBP	Right angle pigtail, 3-wire	100
BK70BB	BK70BBP	Black steel bracket	10

RETAIL

ST70RK		Kit: ST70RB, A70GB & A45PB, clam	6
ST70RS		Red light only, clam	6
ST70AS		Yellow light only, clam	6
ST75AS		Yellow mid-ship turn signal/marker, clam	6

FMVSS ST70RB: S T I P2

ST70AB: I P P2

ST75AB: E P2 A

MATERIALS Polycarbonate lens and housing

VOLT/AMP 12.8VDC - 2.4A Stop/Turn, 0.50A Tail/Parking

WT/DIMS ST70: .265 lb. / 6.5" x 2.313" x 2.375"

ST75: .221 lbs. / 6.5" x 2.313" x 2.75"

WARRANTY Three Year Warranty

SEALED STOP/TURN/TAIL & PARKING/TURN SIGNALS

ST33 SERIES Rectangular Sealed Lights

- Sonically sealed, waterproof
- Shock-proof socket guarantees long bulb life
- Accepts standard PL-3 plug
- Kits include grommet and plug

BULK P/N	POLYPACK P/N	DESCRIPTION	QTY
RED STOP/TURN/TAIL LIGHTS			
ST33RB	ST33RBP	Light	10
ST34RB	ST34RBP	Kit: ST33RB, A33GB & A47PB	50
YELLOW PARKING/TURN LIGHTS			
ST33AB	ST33ABP	Light	10
ACCESSORIES			
A33GB	A33GBP	Grommet	50
A45PB	A45PBP	Pigtail, 3-wire	100
A47PB	A47PBP	Right angle pigtail, 3-wire	100

FMVSS	ST33RB: S T I P 2 ST33AB: I P 2
MATERIALS	Polycarbonate lens and housing
VOLT/AMP	12.8VDC - 2.19A Stop/Turn, 0.49A Tail/Parking
WT/DIMS	.265 lb. / 5.313" x 3.438" x 1.938"
WARRANTY	Three Year Warranty



ST33RB



ST33AB

SEALED STOP/TURN/TAIL & PARKING/TURN SIGNALS

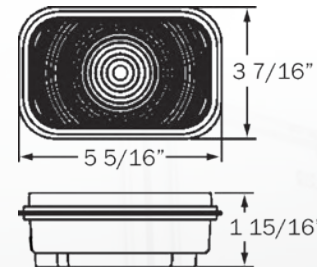

HOLE CUT-OUT: 5.453" X 3.578" (1" R)



ST40/42 SERIES Flush Mount Stop/Turn/Tail Lights

- Flush mount with acrylic lens, steel housing, gasket
- Replaceable lens and bulb
- Shock-proof socket guarantees long bulb life
- Hard wired



ST40RB



ST42RB



A42GB

COMBINATION
TAIL LIGHTS & KITS

BULK P/N	POLYPACK P/N	DESCRIPTION	QTY
RED STOP/TURN/TAIL LIGHTS			
ST40RB	ST40RBP	Light, self grounding	50
ST42RB	ST42RBP	Light with reflex, ground wire	50
ACCESSORIES			
A40SRB	A40SRBP	Snap-in lens retention ring	100
A40RB	A40RBP	Red lens	25
A42GB	A42GBP	Gasket for flange	100
A43RB	A43RBP	Red lens with reflex	25
A2057B	A2057BP	2057 bulb	50
RETAIL			
ST40RS		Light, clam	6

FMVSS	ST40: ST I
	ST42: A I S T
MATERIALS	Acrylic lens, steel housing
VOLT/AMP	12.8VDC - 2.4A Stop/Turn, 0.49A Tail/Parking
WT/DIMS	.221 lbs. / 5.375" x 5.375" x 1.563"
WARRANTY	Three Year Warranty

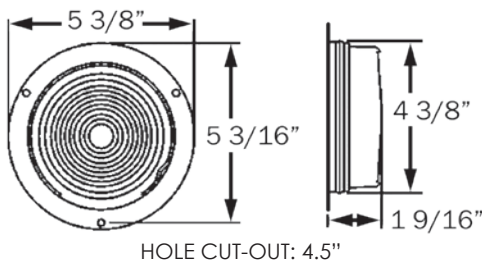

ST90 SERIES

7" Transit Lights for Surface Mount

- Screw-on lens, easy to change bulb
- Surface mount on 6-1/4" centers
- Grounds through mounting hardware
- Acrylic lens, steel base plate

BULK P/N	POLYPACK P/N	DESCRIPTION	QTY
RED STOP/TAIL LIGHTS			
ST90RB	ST90RBP	Light, 1157 bulb	5
YELLOW TURN SIGNAL			
ST90AB	ST90ABP	Light, 1156 bulb	5
ACCESSORIES			
A90RB	A90RBP	Red lens	5
A90AB	A90ABP	Yellow lens	5
A1157B	A1157BP	1157 replacement bulb	50

FMVSS	Red: S T I, Yellow: I
MATERIALS	Acrylic lens and steel housing
VOLT/AMP	12.8VDC - 2.4A Stop, 0.5A Tail/Parking
WT/DIMS	1.146 lbs. / 7.125" x 7.125" x 2.188"
WARRANTY	Three Year Warranty

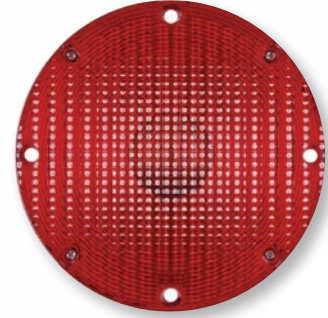

ST90RB

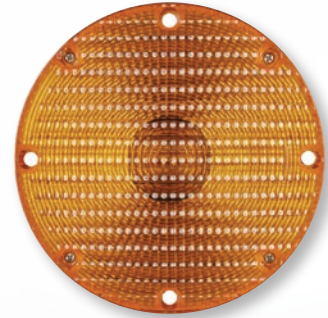

ST90AB

COMBINATION
TAIL LIGHTS & KITS

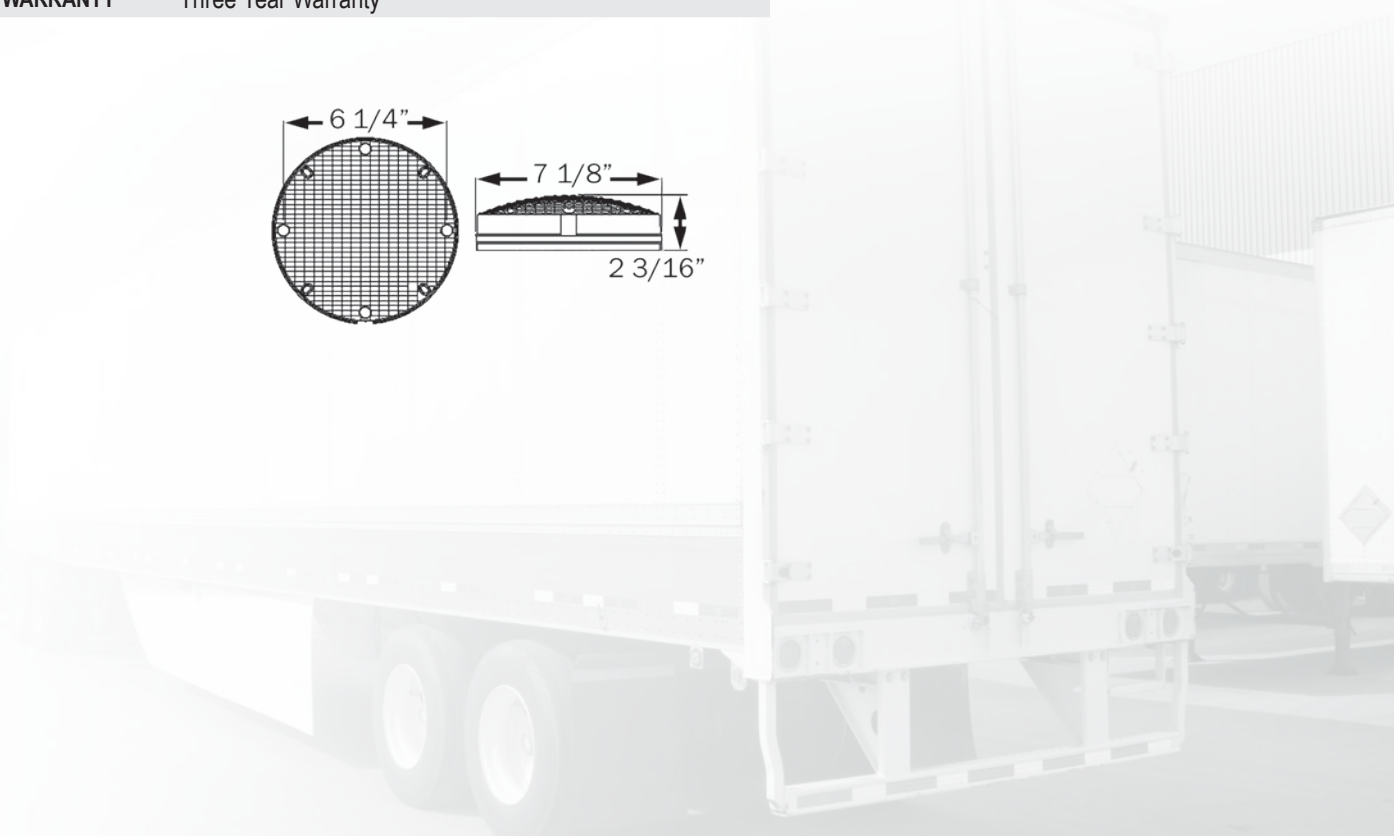
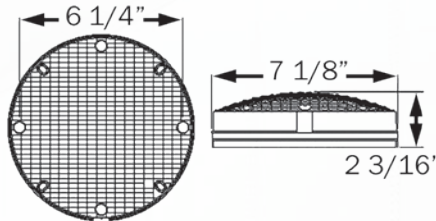

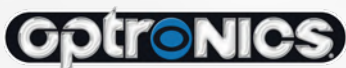

ST92 SERIES 7" Transit Warning Lights for Surface Mount

- School bus warning lamps
- Screw-on lens, easy to change halogen bulb
- Hard wired, includes lead and ground wire
- Acrylic lens, steel base plate



ST92RB



ST92AB

BULK P/N	POLYPACK P/N	DESCRIPTION	QTY
RED WARNING LIGHT			
ST92RB	ST92RBP	Warning light	5
YELLOW WARNING LIGHT			
ST92AB	ST92ABP	Warning light	5
ACCESSORIES			
A94VB	A94VBP	Black visor	25
RETAIL			
A700		12V H3 55W replacement bulb, clam	12

FMVSS	W W2
MATERIALS	Acrylic lens and steel housing
VOLT/AMP	12.8VDC - 4.6A
WT/DIMS	1.146 lbs. / 7.063" x 7.063" x 2.25"
WARRANTY	Three Year Warranty



A94VB

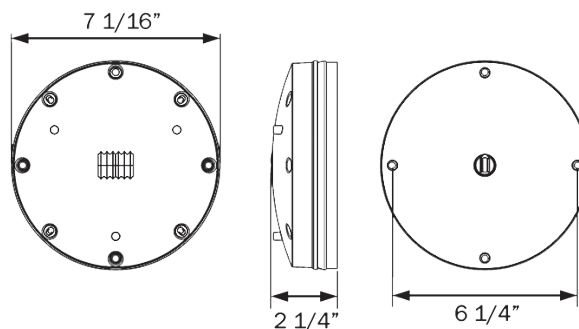

ST51/52/53 SERIES Pedestal Mount Lights

- Snap-on lens, easy to change bulb
- ST51/52 mount with single post and are self grounding; ST53 with dual post mounts on 2" centers and includes ground wire

BULK P/N	POLYPACK P/N	DESCRIPTION	QTY
RED - SINGLE FACE			
ST51RB	ST51RBP	Round, red, single face	10
YELLOW - DUAL FACE			
-	ST52AAP	Round, yellow, dual face	10
ST53AAB	ST53AABP	Square, yellow dual face with side marker/reflex, 1156 bulb	10
RED/YELLOW DUAL FACE			
ST52RB	ST52RBP	Dual face yellow/red stop/turn/tail light	10
ACCESSORIES			
A52RB	A52RBP	Red lens, round	25
A52AB	A52ABP	Yellow lens, round	25
A2057B	A2057BP	2057 replacement bulb	50
RETAIL			
ST51RS		Red stop/turn/tail light, clam	6
ST52AA		Dual yellow/yellow parking/turn, clam	6
ST52RA		Dual yellow/red stop/turn/tail light, clam	6

FMVSS	ST51/52:	S T I
	ST53AA:	Tail: S T I P, Side marker/reflex: P2 A
MATERIALS	ST51/52:	Acrylic lens and plastic housing
	ST53AA:	Acrylic lens and plastic housing
VOLT/AMP	ST51/52:	12.8VDC - 2.3A Stop/Turn, 1.2A Tail/Parking
	ST53AA:	12.8VDC - 2.3A Stop/Turn, .248A Marker
WT/DIMS	ST51/52:	.463 lb. / 4.313" x 4.313" x 2.375"
	ST53AA:	.794 lb. / 4.563" x 5" x 2.5"
WARRANTY	Three Year Warranty	

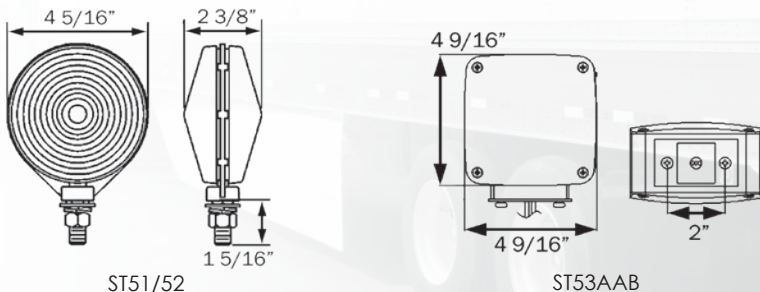

Optronics



COMBINATION
TAIL LIGHTS & KITS



ST24/25 SERIES

Stud Mount Stop/Turn/Tail Lights



ST24RB



ST25RB

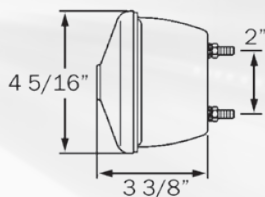

- Snap-on lens, easy to change bulb
- Stud mount on 2" centers
- Grounds through mounting hardware
- Acrylic lens, corrosion proof plastic housing
- Driver side light includes license illuminator

BULK P/N	POLYPACK P/N	DESCRIPTION	QTY
----------	--------------	-------------	-----

STOP/TURN/TAIL LIGHTS

ST24RB	ST24RBP	Passenger side light	50
ST25RB	ST25RBP	Driver side light with license illuminator	50

ACCESSORIES

A24RB	A24RBP	Red lens	25
A2057B	A2057BP	2057 replacement bulb	50

FMVSS ST24RB: S T I P, ST25RB: S T I P L

MATERIALS Acrylic lens and plastic housing

VOLT/AMP 12.8VDC - 2.5A Stop/Turn, 1.0A Tail

WT/DIMS .309 lb. / 4.313" x 4.313" x 3.375"

WARRANTY Three Year Warranty

COMBINATION
TAIL LIGHTS & KITS



ST20/21 SERIES

Surface Mount Stop/Turn/Tail Lights



ST21RS



ST20RS

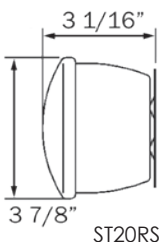

ST20RS

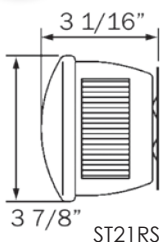

ST21RS

- Screw-on lens, easy to change bulb
- Surface mount on 2" centers
- Grounds through mounting hardware
- Acrylic lens, steel housing
- Driver side light includes license illuminator

BULK P/N	POLYPACK P/N	DESCRIPTION	QTY
----------	--------------	-------------	-----

RETAIL

ST20RS		Passenger side, clam	6
ST21RS		Driver side, clam	6
A20R		Red lens, slipover blister	12

ACCESSORIES

A1157B	A1157BP	1157 replacement bulb	50
--------	---------	-----------------------	----

FMVSS ST20RS: S T I, ST21RS: S T I L

MATERIALS Acrylic lens and steel housing

VOLT/AMP 12VDC - 2.3A Stop/Turn, 0.90A Tail

WT/DIMS .551 lbs / 3.875" x 3.875" x 3.063"

WARRANTY Three Year Warranty

ST8/9 SERIES

Universal Mount Combination Tail Lights

- Screw-on lens, easy to change bulbs
- Stud mount on 2" centers
- Grounds through mounting studs
- Shock-proof socket guarantees long bulb life
- Acrylic lens, corrosion proof plastic housing
- Passenger side light is 6-function: stop, turn, tail, rear reflex, side marker, and side reflex
- Driver side light also includes license illuminator
- Bulk models are designed with Plug-n-go connections for quick connect wiring
- Retail models are hard wired, self grounding

BULK P/N	POLYPACK P/N	DESCRIPTION	QTY
STOP/TURN/TAIL LIGHTS			
ST8RB	ST8RBP	Passenger side light	50
ST9RB	ST9RBP	Driver side light with license illuminator	50
ST8RHB	ST8RHBP	Passenger side light, hard wired	50
ST9RHB	ST9RHBP	Driver side light, hard wired	50
TL27BK	-	Kit: ST8RB, ST9RB, (2) MC36AB amber marker lights with reflex, LP10SB license plate bracket; 20-ft harness, box	1
TL29BK	-	Kit: ST8RB, ST9RB, (2) MC36AB amber marker lights with reflex, LP10SB license plate bracket; 25-ft harness, box	1
ACCESSORIES			
A8RB	A8RBP	Tail light lens	50
A9RB	A9RBP	Side marker light lens	50
A1157B	A1157BP	1157 replacement bulb	50
RETAIL			
ST8RS		Passenger side light, clam	6
ST9RS		Driver side with license illuminator, clam	6
TL11RK		Kit: ST8RB, ST9RB, license plate bracket, 20-ft harness, mounting hardware, clam	3
TL8RK		Kit: ST8RB, ST9RB, license plate bracket, 20-ft harness, mounting hardware, clam	2
A8RK		Tail and side marker lens set, clam	12
A8R		Tail light lens, clam	12
A9R		Side marker light lens, clam	12
FMVSS	ST8RB: A S T, A P2, ST9RB: A S T, A P2, L		
MATERIALS	Acrylic lens and plastic housing		
VOLT/AMP	12.8VDC - 2.5A Stop/Turn, 1.0A Tail		
WT/DIMS	.309 lb. / 4.563" x 4.563" x 2.875"		
WARRANTY	Three Year Warranty		



ST9RB



ST8RB



TL8RK

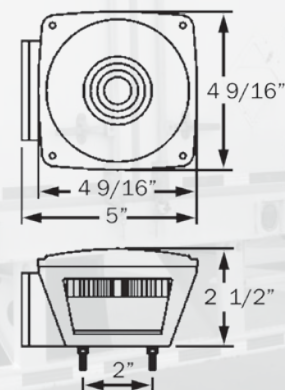

COMBINATION
TAIL LIGHTS & KITS

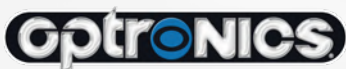

ST6/7 SERIES

Submersible Universal Mount Combination Tail Lights



ST7RB

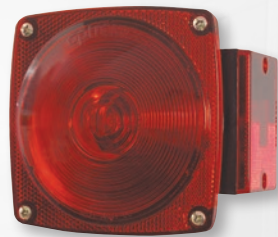

ST6RB



TL5RK

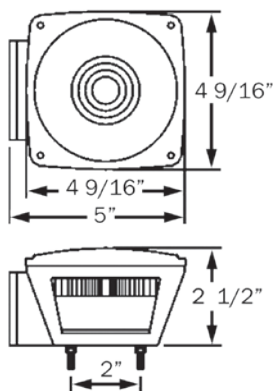

- Submersible design suitable for many applications
- Screw-on lens, easy to change bulbs
- Stud mount on 2" centers
- Grounds through mounting studs
- Shock-proof socket guarantees long bulb life
- Acrylic lens, corrosion proof plastic housing
- Passenger side light is 6-function: stop, turn, tail, rear reflex, side marker, and side reflex
- Driver side light also includes license illuminator

BULK P/N	POLYPACK P/N	DESCRIPTION	QTY
STOP/TURN/TAIL LIGHTS			
ST6RB	ST6RBP	Passenger side light	50
ST7RB	ST7RBP	Driver side light with license illuminator	50
ST6RPG	ST6RPGP	Passenger side light, 2-way plug	50
ST7RPG	ST7RPGP	Driver side light with license illuminator, 2-way plug	50
ACCESSORIES			
A8RB	A8RBP	Tail light lens	50
A9RB	A9RBP	Side marker light lens	25
A1157B	A1157BP	1157 replacement bulb	50
RETAIL			
ST6RS		Passenger side light, clam	6
ST7RS		Driver side with license illuminator, clam	6
TL5RK		Deluxe kit: ST6RB, ST7RB, (2) MC36AB amber marker lights with reflex, LP10SB license plate bracket, 25-ft harness, mounting hardware, clam	2
TL14RK		Kit: ST6RB, ST7RB, (2) MC31AB amber marker lights with reflex, LP10SB license plate bracket, 25-ft. harness, mounting hardware, clam	2
TL9RK		Kit: ST6RB, ST7RB, LP10SB license plate bracket, 25-ft harness, mounting hardware, clam	2
A8RK		Tail and side marker lens set, clam	12
A8R		Tail light lens, clam	12
A9R		Side marker light lens, clam	12
FMVSS	ST6RB: A S T, A P2, ST7RB: A S T, A P2, L		
MATERIALS	Acrylic lens and plastic housing		
VOLT/AMP	12.8VDC - 2.5A Stop/Turn, 1.0A Tail		
WT/DIMS	.309 lb. / 4.563" x 4.563" x 2.875"		
WARRANTY	Three Year Warranty		

COMBINATION
TAIL LIGHTS & KITS

ST2/3 SERIES

Universal Mount Combination Tail Lights for Over 80" Applications

- Screw-on lens, easy to change bulbs
- Stud mount on 2" centers
- Grounds through mounting studs
- Shock-proof socket guarantees long bulb life
- Acrylic lens, corrosion proof plastic housing
- Passenger side light is 7-function: stop, turn, tail, rear clearance, rear reflex, side marker, and side reflex
- Driver side light also includes license illuminator
- Designed with Plug-n-go connections for quick connect wiring
- Also available in hard wired models



ST3RB



ST2RB

COMBINATION
TAIL LIGHTS & KITS

BULK P/N	POLYPACK P/N	DESCRIPTION	QTY
STOP/TURN/TAIL LIGHTS			
ST2RB	ST2RBP	Passenger side, quick connect	50
ST2RHB	ST2RHBP	Passenger side, hard wired	50
ST3RB	ST3RBP	Driver side with license illuminator, quick connect	50
ST3RHB	ST3RHBP	Driver side, hard wired	50
ACCESSORIES			
A8RB	A8RBP	Tail light lens	50
A2RB	A2RBP	Side marker light lens	25
A1157B	A1157BP	1157 replacement bulb	50

FMVSS	ST2RB: S T I A, P2 P C A, ST3RB: S T I A, P2 P C A, L
MATERIALS	Acrylic lens and plastic housing
VOLT/AMP	12.8VDC - 2.5A Stop/Turn, 1.0A Tail
WT/DIMS	.441 lb. / 6.125" x 4.563" x 2.875"
WARRANTY	Three Year Warranty

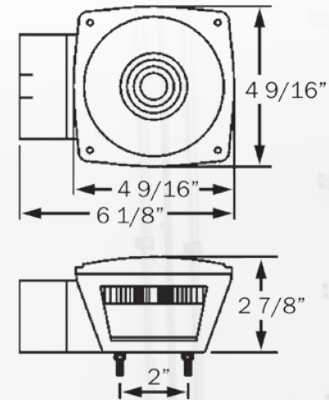



ST4/5 SERIES

Submersible Universal Mount Combination Tail Lights for Over 80" Applications





ST5RB



ST4RB

- Submersible design suitable for many applications
- Screw-on lens, easy to change bulbs
- Stud mount on 2" centers
- Grounds through mounting studs
- Shock-proof socket guarantees long bulb life
- Acrylic lens, corrosion proof plastic housing
- Passenger side light is 7-function: stop, turn, tail, rear clearance, rear reflex, side marker, and side reflex
- Driver side light also includes license illuminator

COMBINATION
TAIL LIGHTS & KITS

BULK P/N	POLYPACK P/N	DESCRIPTION	QTY
STOP/TURN/TAIL LIGHTS			
ST4RB	ST4RBP	Passenger side light	50
ST5RB	ST5RBP	Driver side light with license illuminator	50
ACCESSORIES			
A8RB	A8RBP	Tail light lens	50
A2RB	A2RBP	Side marker light lens	25
A1157B	A1157BP	1157 replacement bulb	50
RETAIL			
ST4RS		Passenger side light, clam	6
ST5RS		Driver side with license illuminator, clam	6
TL60RK		Set: ST4RB, ST5RB, mounting hardware, clam	2
A8R		Tail light lens, clam	12



TL60RK

FMVSS	ST6RB: S T I A, A P2, ST7RB: S T I A, A P2, L
MATERIALS	Acrylic lens and plastic housing
VOLT/AMP	12.8VDC - 2.5A Stop/Turn, 1.0A Tail
WT/DIMS	.441 lb. / 6.125" x 4.563" x 2.875"
WARRANTY	Three Year Warranty

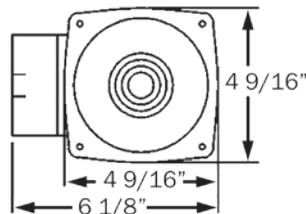
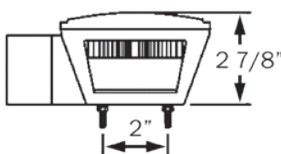

ST16/17 SERIES

Waterproof Universal Mount Combination Tail Lights

- Waterproof, low profile design for marine applications
- Replaceable lenses and bulbs
- Mount on 2" centers
- Includes separate ground wire with eyelet
- Acrylic lens, corrosion proof plastic housing
- Passenger side light is 7-function: stop, turn, tail, rear clearance, rear reflex, side marker, and side reflex
- Driver side light also includes license illuminator

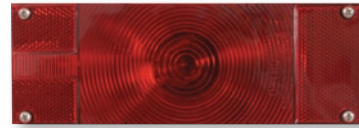

ST17RB

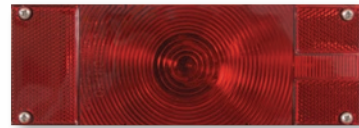

ST16RB

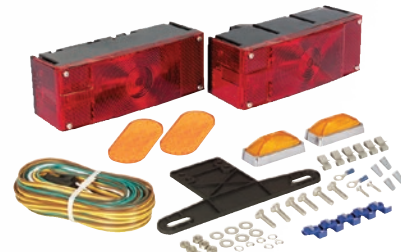

TL16RK

BULK P/N	POLYPACK P/N	DESCRIPTION	QTY
STOP/TURN/TAIL LIGHTS			
ST16RB	ST16RBP	Passenger side light	20
ST17RB	ST17RBP	Driver side light with license illuminator	20
ST26RPG	ST26RPGP	Passenger side light, self grounding, 2-way plug	20
ST27RPG	ST27RPGP	Driver side light with license illuminator, self grounding, 2-way plug	20
ACCESSORIES			
A16RB	A16RBP	Tail light lens	50
A17RB	A17RBP	Side marker light lens	50
A2057B	A2057BP	2057 replacement bulb	50

RETAIL			
ST16RS		Passenger side light, clam	6
ST17RS		Driver side with license illuminator, clam	6
TL16RK		Deluxe kit: ST16RB, ST17RB, LP10SB license plate bracket, (2) MC91AB yellow marker lights with bases, (2) RE11AB yellow reflectors, 25-ft harness, stainless steel mounting hardware, clam	2
TL15RK		Kit: ST16RB, ST17RB, LP10SB license plate bracket, 25-ft harness, mounting hardware, clam	2
A16R		Tail light lens, clam	12

FMVSS	ST16RB: S T I A P 2 PC; ST17RB: S T I A P 2 PC, L
MATERIALS	Acrylic lens and plastic housing
VOLT/AMP	12.8VDC - 2.3A Stop/Turn, 0.9A Tail
WT/DIMS	.661 lb. / 8.063" x 2.875" x 2.813"
WARRANTY	Three Year Warranty



TL15RK

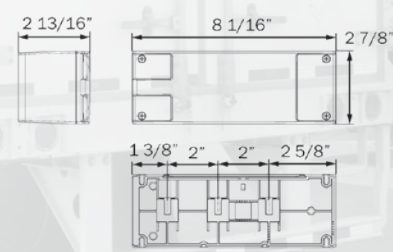

COMBINATION TAIL LIGHTS & KITS



ST36/37 SERIES

Waterproof Universal Mount Combination Tail Lights

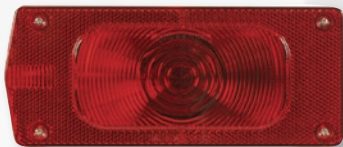

ST37RPG



ST36RPG



TL36RK

- Waterproof, low profile design for marine applications
- Screw-on lens, easy to change bulbs
- Mount on 2" centers
- Includes separate ground wire with eyelet
- Shock-proof socket guarantees long bulb life
- Acrylic lens, corrosion proof plastic housing
- Passenger side light is 7-function: stop, turn, tail, rear clearance, rear reflex, side marker, and side reflex
- Driver side light also includes license illuminator
- Stainless steel mounting hardware

BULK P/N	POLYPACK P/N	DESCRIPTION	QTY
STOP/TURN/TAIL LIGHTS			
ST36RPG	ST36RPGP	Passenger side light, self grounding, 2-way plug	20
ST37RPG	ST37RPGP	Driver side light with license illuminator, self grounding, 2-way plug	20
ACCESSORIES			
A39RB	A39RBP	Tail light lens	10
A37RB	A37RBP	Side marker light lens	50
A1157B	A1157BP	1157 replacement bulb	50
RETAIL			
ST36RS		Passenger side light, clam	6
ST37RS		Driver side with license illuminator, clam	6
TL36RK		Deluxe kit: ST36RB, ST37RB, LP10SB license plate bracket, (2) MC91AB yellow marker lights with bases, 25-ft harness, stainless steel mounting hardware, clam	2
A36R		Tail and marker light lenses, clam	12

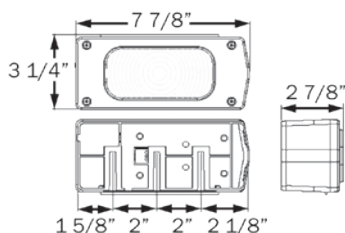

FMVSS	ST36RB: S T I A P2, A P2; ST37RB: S T I A P2, A P2, L
MATERIALS	Acrylic lens and plastic housing
VOLT/AMP	12.8VDC - 2.3A Stop/Turn, 0.9A Tail
WT/DIMS	.992 lb. / 7.875" x 3.25" x 2.875"
WARRANTY	Three Year Warranty

ST56/57 SERIES

Submersible Universal Mount Combination Tail Lights for Over 80" Applications

- Waterproof design for marine applications
- Shock mount guarantees long bulb life
- Mount on 2" centers
- Includes separate ground wire with eyelet
- Acrylic lens, corrosion proof plastic housing
- Passenger side light is 7-function: stop, turn, tail, rear clearance, rear reflex, side marker, and side reflex
- Driver side light also includes license illuminator
- Stainless steel mounting hardware

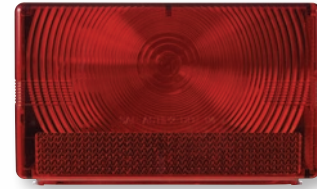

ST57RS

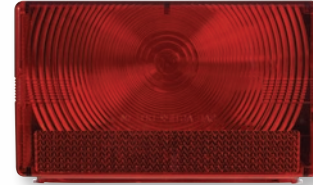

ST56RS

BULK P/N	POLYPACK P/N	DESCRIPTION	QTY
RETAIL			
ST56RS		Passenger side light, clam	6
ST57RS		Driver side with license illuminator, clam	6
ACCESSORIES			
A2057B	A2057BP	2057 replacement bulb	50
A194B	A194BP	194 replacement bulb	100

FMVSS	ST56RB: S2 T2 I6 PC A; ST57RB: S2 T2 I6 PC A, L
MATERIALS	Acrylic lens and plastic housing
VOLT/AMP	12.8VDC - 2.3A Stop/Turn, 0.9A Tail
WT/DIMS	.639 lb. / 6.063" x 3.75" x 2.25"
WARRANTY	Three Year Warranty

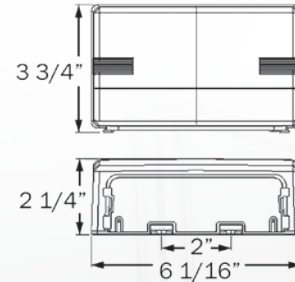

COMBINATION
TAIL LIGHTS & KITS



ST60 SERIES

Universal Mount Combination Tail Lights

- Stud mount stop/turn/tail light with back-up and license illuminator built in
- Screw-on lens, easy to change bulbs
- Grounds through mounting studs
- Shock-proof socket guarantees long bulb life
- Acrylic lens, corrosion proof plastic housing



ST60RB

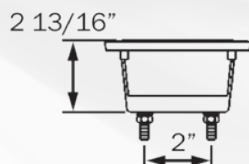
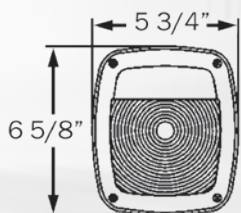

BULK P/N	POLYPACK P/N	DESCRIPTION	QTY
----------	--------------	-------------	-----

STOP/TURN/TAIL LIGHTS

ST60RB	ST60RBP	Combination tail light	20
--------	---------	------------------------	----

ACCESSORIES

A60RB	A60RBP	Tail light lens	25
A2057B	A2057BP	2057 replacement bulb	50

RETAIL

ST60RS		Combination tail light, clam	6
--------	---	------------------------------	---

FMVSS	STAIR
MATERIALS	Acrylic lens and plastic housing
VOLT/AMP	12.8VDC - 2.3A Stop/Turn, 0.9A Tail
WT/DIMS	.992 lb. / 5.75" x 6.625" x 2.813"
WARRANTY	Three Year Warranty

COMBINATION
TAIL LIGHTS & KITS



ST31 SERIES

Weatherproof Surface Mount Light

- Snap-on lens, easy to change bulb
- Surface mount on 3-1/2" centers
- Hard wired, includes lead and ground wire
- Polycarbonate lens, steel base plate



ST31RS

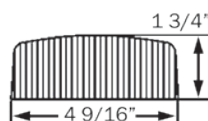
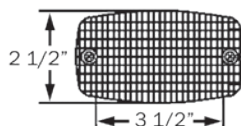

BULK P/N	POLYPACK P/N	DESCRIPTION	QTY
----------	--------------	-------------	-----

RETAIL

ST31RS		Light, clam	12
--------	---	-------------	----

ACCESSORIES

A2057B	A2057BP	2057 replacement bulb	50
--------	---------	-----------------------	----

FMVSS	ST I
MATERIALS	Polycarbonate lens and steel housing
VOLT/AMP	12.8VDC - 2.3A Stop/Turn, 0.90A Tail
WT/DIMS	.309 lb. / 4.563" x 2.5" x 1.75"
WARRANTY	Three Year Warranty

TL21/22RK Magnetic Mount Towing Light Kit

- Magnetic mount towing light kit
- Pair of DOT compliant stop/turn/tail lights
- 20-ft wishbone style wiring harness and 4-ft trunk connector with 4-way flat plug
- Replaceable lens and bulb

BULK P/N	POLYPACK P/N	DESCRIPTION	QTY
RETAIL			
TL21RK		Towing light kit, heavy duty	2
TL22RK		Towing light kit	2
ACCESSORIES			
A52RB	A52RBP	Tail light lens	25
A2057B	A2057BP	2057 replacement bulb	50

FMVSS	S T I
MATERIALS	Acrylic lens and plastic housing
VOLT/AMP	12.8VDC - 2.3A Stop/Turn, 0.9A Tail
WT/DIMS	3.53 lbs. / 7" x 4" x 2.125"
WARRANTY	Three Year Warranty

Optronics



TL22RK



TL21RK

COMBINATION
TAIL LIGHTS & KITS



BU11CS Back-Up Light



BU11CS

- Single wire, grounds through mounting hardware
- Replaceable bulb (1156)

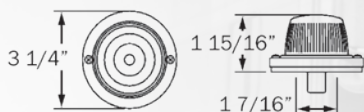

BULK P/N	POLYPACK P/N	DESCRIPTION	QTY
RETAIL			
BU11CS		Back-up light, chrome housing	12
FMVSS	R		
MATERIALS	Polycarbonate lens and plastic housing		
VOLT/AMP	12.8VDC - 0.4A		
WT/DIMS	.221 lbs. / 3.25" x 3.25" x 1.938"		
WARRANTY	Three Year Warranty		

DOT COMPLIANT
BACK-UP LIGHTS



BU41 SERIES Flange Mount Back-Up Light

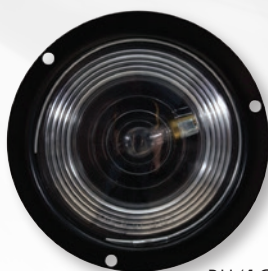

BU41CB

- Hard wired, includes both lead and ground wire
- Replaceable bulb (1056)

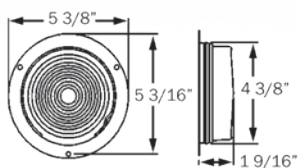

BULK P/N	POLYPACK P/N	DESCRIPTION	QTY
BACK-UP LIGHT			
BU41CB	BU41CBP	Back-up light	50
ACCESSORIES			
A40SRB	A40ARBP	Snap retention ring	300
A41CB	A41CBP	Clear replacement lens for BU41	25

FMVSS	R		
MATERIALS	Acrylic lens, steel housing		
VOLT/AMP	12.8VDC - 1.182A		
WT/DIMS	.441 lbs. / 5.375" x 5.375" x 1.563"		
WARRANTY	Three Year Warranty		

BU33/45/70 SERIES Sealed Back-Up Lights

- 4" round, 6" oval and rectangular models
- Sonically sealed, waterproof
- Flush mount design accepts standard two-way plug
- Shock proof socket guarantees long bulb life
- Kits include grommet and plug

BULK P/N	POLYPACK P/N	DESCRIPTION	QTY
4" ROUND BACK-UP LIGHTS			
BU45CB	BU45CBP	Back-up light	50
BU44CB	BU44CBP	Kit: BU45CB, A45GB & A45CB	50
BU49CB	BU49CBP	Kit: BU45CB & A45GB	10
6" OVAL BACK-UP LIGHTS			
BU70CB	BU70CBP	Back-up light	50
BU74CB	BU74CBP	Kit: BU70CB, A70GB & A45CB	50
BU64CB	BU64CBP	Kit: BU70CB, A70GB & A49PB (pigtail attached to light)	50
RECTANGULAR BACK-UP LIGHTS			
BU33CB	BU33CBP	Back-up light	10
BU33CRXLB	BU33CRXLBP	Back-up light with red reflex	20
BU33CRX24LB	BU33CRX24LBP	Back-up light with red reflex, 24V	20
ACCESSORIES			
A45GB	A45GBP	4" round grommet	50
A70GB	A70GBP	6" oval grommet	50
A33GB	A33GBP	Rectangular grommet	50
A45CB	A45CBP	Straight two-wire pigtail	100
A49PB	A49BPB	Right angle two-wire pigtail	100

FMVSS	R BU33CRX: (2)R A
MATERIALS	Polycarbonate lens and housing
VOLT/AMP	BU45: 12.8VDC - 2.182A BU70: 12.8VDC - 0.4A BU33: 12.8VDC - 1.6A; 24.0VDC - .87A
WT/DIMS	BU45: .176 lbs. / 4.25" x 4.25" x 2.063" BU70: .265 lbs. / 6.5" x 2.25" x 2.375" BU33: .441 lbs. / 5.313" x 3.438" x 1.938"
WARRANTY	Three Year Warranty



BU45CB

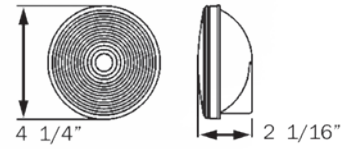

HOLE CUT-OUT: 4.5"



BU70CB

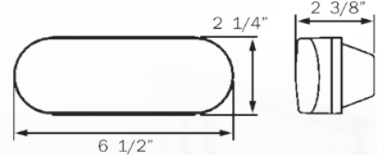

HOLE CUT-OUT: 6.85" x 2.5" (1.25" R)



BU33CB



BU33CRXLB

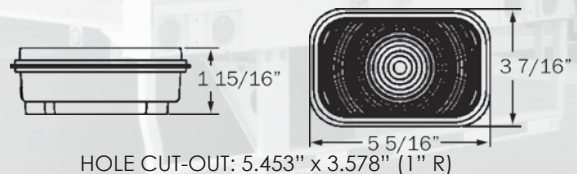

HOLE CUT-OUT: 5.453" x 3.578" (1" R)

DOT COMPLIANT
BACK-UP LIGHTS



M1 SERIES Millennium Series® 6.5" Marker/Clearance Lights

- Replaceable lens and bulb
- Hard wired, includes separate ground wire
- Available with .180 male bullets or metripack connector
- Choose from light only or kit with chrome bezel



M1 WITH BEZEL



M1 WITH BEZEL

BULK P/N	POLYPACK P/N	DESCRIPTION	QTY
YELLOW			
00212351B	00212351P	12V, .180 bullets	20
00212331B	00212331P	12V Kit: .180 bullets, bezel	20
00212362B	00212362P	12V, Metripack connector	20
00212342B	00212342P	12V Kit: Metripack connector, bezel	20
RED			
00212333B	00212333P	12V Kit: .180 bullets, bezel	20
ACCESSORIES			
00212317B	00212327P	Bezel	100/20



FMVSS	P2
MATERIALS	Polycarbonate lens, housing and bezel
VOLT/AMP	12.8VDC - 0.33A; 24.0VDC - 0.17A
WT/DIMS	.22 lbs. / 6.625" x 2.188" x 1"
WARRANTY	Three Year Warranty

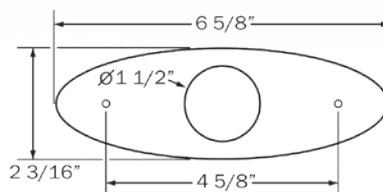

HOLE CUT-OUT: 1.5"

M3 SERIES Millennium Series® 3" Marker/Clearance Lights

- Replaceable lens and bulb
- Hard wired, includes separate ground wire
- Molded .180 male bullets

BULK P/N	POLYPACK P/N	DESCRIPTION	QTY
YELLOW			
00212251B	00212251P	.180 bullets	20
RED			
00212253B	00212253P	.180 bullets	20
00212233B	00212233P	Kit: .180 bullets, bezel	20
CLEAR			
00212239B	00212239P	Kit: .180 bullets, bezel	20
ACCESSORIES			
00212217B	00212227P	Bezel	500/20

FMVSS	P2
MATERIALS	Polycarbonate lens, housing and bezel
VOLT/AMP	12.8VDC - 0.33A
WT/DIMS	.20 lbs. / 3" x 2" x 1"
WARRANTY	Three Year Warranty

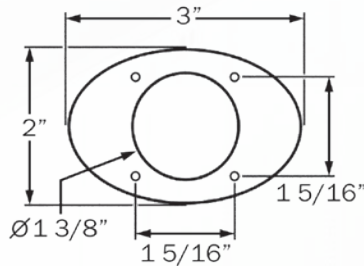

HOLE CUT-OUT: 1.375"

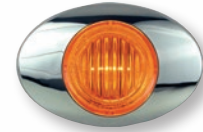

M3 WITH BEZEL



M3 WITH BEZEL



M3 CLEAR LENS WITH BEZEL



MILLENNIUM SERIES
MARKER/CLEARANCE LIGHTS



MC25/27 SERIES 2" & 2.5" Sealed Beehive Style Marker/Clearance Lights

- Sonically sealed, waterproof
- Accepts standard two-pin PL-10 plug



MC25AB



MC27AB

SEALED MARKER/
CLEARANCE LIGHTS

BULK P/N	POLYPACK P/N	DESCRIPTION	QTY
YELLOW			
MC25AB	MC25ABP	2" light	20
MC27AB	MC27ABP	2.5" light	20
ACCESSORIES			
A46PB	A46PBP	Straight PL-10 plug, 6" lead	100
A86PB	A86PBP	Straight PL-10 plug, 18" lead	100
A54GB	A54GBP	2" Flush mount grommet	100
A54GK	A54GKP	2" Kit: A54GB and A46PB	100
A55CB	A55CBP	2" Chrome trim ring	20
A55GB	A55GBP	2.5" Flush mount grommet (open back)	50
A56GB	A56GBP	2.5" Recess mount grommet (closed back)	100
A57GB	A57GBP	2.5" Recess mount grommet (open back)	50
A55GK	A55GKP	2.5" Kit: A55GB and A46PB	100
A57GK	A57GKP	2.5" Kit: A57GB and A46PB	100
A57CB	A57CBP	2.5" Chrome trim ring	20
BK5557GB	BK5557GBP	2"/2.5" Cam-on mounting bracket	50

FMVSS	P2
MATERIALS	Polycarbonate lens and housing
VOLT/AMP	12.8VDC - 0.2A
WT/DIMS	MC25: .088 lbs. / 2" x 2" x 1.75" MC27: .110 lbs. / 2.5" x 2.5" x 2.313"
WARRANTY	Three Year Warranty

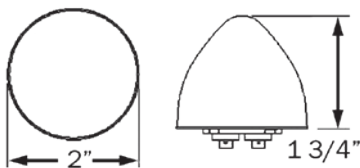

MC25 SERIES
HOLE CUT-OUT: 2.313"

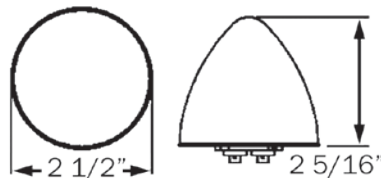

MC27 SERIES
HOLE CUT-OUT: 2.75"

MC52 SERIES

2" Round Sealed Recess Flange Mount Marker/Clearance Lights

- Sonically sealed, waterproof light for recess mount
- Accepts standard two-pin PL-10 plug
- Available in yellow and red models, with black or reflex flange
- Reflex flange model meets SAE "A" requirements for conspicuity

BULK P/N	POLYPACK P/N	DESCRIPTION	QTY
YELLOW			
MC52AB	MC52ABP	Yellow, black flange	50
MC52AXB	MC52AXBP	Yellow, reflex lens and flange	50
RED			
MC52RB	MC52RBP	Red, black flange	50
MC52RXB	MC52RXBP	Red, reflex lens and flange	50
ACCESSORIES			
A46PB	A46PBP	Straight PL-10 plug, 6" lead	100
A86PB	A86PBP	Straight PL-10 plug, 18" lead	100
A3TRSSB	A3TRSSBP	Stainless steel flange cover	100

FMVSS	Black flange: P2 Reflex flange: A P2
MATERIALS	Polycarbonate lens and housing
VOLT/AMP	12.8VDC - 0.2A
WT/DIMS	Black flange: .066 lbs. / 2.938" x 2.938" x .813" Reflex flange: .066 lbs. / 2.984" x 2.984" x .75"
WARRANTY	Three Year Warranty

optronics



MC52AB



MC52RB

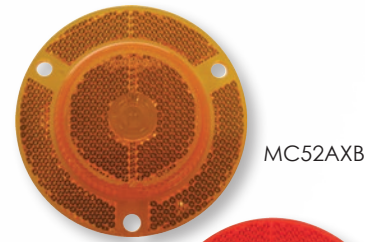

MC52AXB



MC52RXB

SEALED MARKER/
CLEARANCE LIGHTS

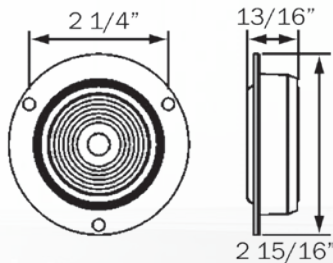

MC52 Black Flange

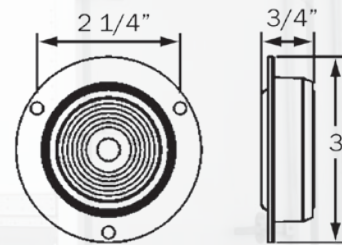

MC52 Reflex Flange



MC53 & MC54 SERIES 2" Sealed Marker/Clearance Lights



- Sonically sealed, waterproof
- Accept standard two-pin PL-10 plugs
- Available in yellow, red, and yellow ABS models
- Available in recess and surface mount models



MC53RB

MC53AB



MC53ABSB

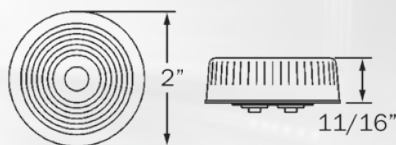

HOLE CUT-OUT: 2.313"



MC54AB

MC54RB



MC505ABSB

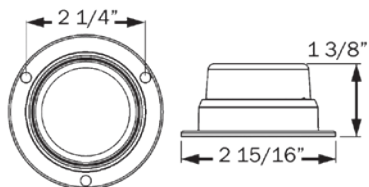

SURFACE MOUNT



BULK P/N	POLYPACK P/N	DESCRIPTION	QTY
YELLOW			
MC53AB	MC53ABP	Recess mount	50
MC53ABSB	MC53ABSBP	Recess mount "ABS"	50
MC53AKB	MC53AKBP	Kit: MC53AB, A54GB and A46PB	50
MC54AB	MC54ABP	Flange surface mount	50
MC505ABSB	MC505ABSBP	Flange surface mount "ABS"	50
RED			
MC53RB	MC53RBP	Recess mount	50
MC53RKB	MC53RKBP	Kit: MC53RB, A54GB and A46PB	50
MC54RB	MC54RBP	Flange surface mount	50
ACCESSORIES			
A46PB	A46PBP	Straight PL-10 plug, 6" lead	100
A86PB	A86PBP	Straight PL-10 plug, 18" lead	100
A54GB	A54GBP	2" Flush mount grommet	100
A54GK	A54GKP	2" Kit: A54GB and A46PB	100
A55CB	A55CBP	2" Chrome trim ring	20
BK5557GB	BK5557GBP	Cam-on mounting bracket	50
RETAIL			
MC53AS		Yellow recess mount light, clam	12
MC53RS		Red recess mount light, clam	12

FMVSS	P2 PC
MATERIALS	Polycarbonate lens and housing
VOLT/AMP	12.8VDC - 0.2A
WT/DIMS	MC53: .066 lbs. / 2" x 2" x .688" MC54/505: .066 lbs. / 2.938" x 2.938" x .813"
WARRANTY	Three Year Warranty

SEALED MARKER/
CLEARANCE LIGHTS

MC55 & MC57 SERIES 2.5" Sealed Marker/Clearance Lights for Recess Mount

- Sonically sealed, waterproof design for recess mount
- Accept standard two-pin PL-10 plug
- MC55 series lights are PC rated
- MC57 series lights feature built-in reflex

BULK P/N	POLYPACK P/N	DESCRIPTION	QTY
YELLOW			
MC55AB	MC55ABP	PC rated light	50
MC57AB	MC57ABP	P2 rated light with reflex	50
RED			
MC55RB	MC55RBP	PC rated light	50
MC57RB	MC57RBP	P2 rated light with reflex	50
ACCESSORIES			
A46PB	A46PBP	Straight PL-10 plug, 6" lead	100
A86PB	A86PBP	Straight PL-10 plug, 18" lead	100
A55GB	A55GBP	Flush mount grommet, open back	50
A56GB	A56GBP	Recess mount grommet, closed back	100
A57GB	A57GBP	Recess mount grommet, open back	50
A55GK	A55GKP	Kit: A55GB & A46PB	100
A57GK	A57GKP	Kit: A57GB & A46PB	100
A57CB	A57CBP	Chrome trim ring	20
BK5557GB	BK5557GBP	Cam-on mounting bracket	50
RETAIL			
MC57AS		Yellow light with reflex, clam	12
MC57RS		Red light with reflex, clam	12

FMVSS	MC55: P2 PC MC57: A P2
MATERIALS	Polycarbonate lens and housing
VOLT/AMP	12.8VDC - 0.2A
WT/DIMS	.066 lbs. / 2.5" x 2.5" x .688"
WARRANTY	Three Year Warranty



MC55AB

MC55RB

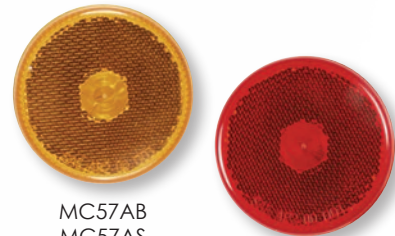
MC57AB
MC57AS

MC57RB
MC57RS

**SAE A REFLEX
P2 RATED**

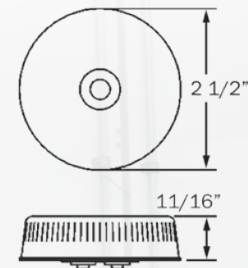

HOLE CUT-OUT: 2.75"

SEALED MARKER/
CLEARANCE LIGHTS



MC56 SERIES

2.5" Sealed Recess Flange Mount Marker/Clearance Lights



- Sonically sealed, waterproof light for recess mount
- Accepts standard two-pin PL-10 plug

BULK P/N	POLYPACK P/N	DESCRIPTION	QTY
YELLOW			
MC56AB	MC56ABP	Recess flange mount	50
RED			
MC56RB	MC56RBP	Recess flange mount	50
ACCESSORIES			
A46PB	A46PBP	Straight PL-10 plug, 6" lead	100
A86PB	A86PBP	Straight PL-10 plug, 18" lead	100

FMVSS	P2
MATERIALS	Polycarbonate lens and housing
VOLT/AMP	12.8VDC - 0.2A
WT/DIMS	.11 lb. / 3.438" x 3.438" x .938"
WARRANTY	Three Year Warranty

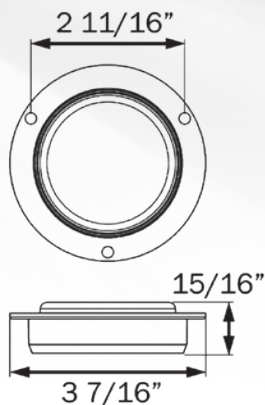

HOLE CUT-OUT: 2.75"

SEALED MARKER/
CLEARANCE LIGHTS

MC61ABKB

Sealed Marker/Clearance Light and Reflector in Elevated Bracket



- Sonically sealed, waterproof
- PC rated light fulfills front side marker requirement when properly mounted on a 15 degree angle
- Corrosion proof, surface mount wedge base
- Single wire design grounds through mounting hardware



MC61ABKB

BULK P/N	POLYPACK P/N	DESCRIPTION	QTY
LIGHT/REFLECTOR ASSEMBLY			
MC61ABKB	MC61ABKBP	Light & reflector in bracket	20

FMVSS	Light: P2 PC; Reflector: A
MATERIALS	Polycarbonate lens and housing; Acrylic reflector
VOLT/AMP	12.8VDC - 0.2A
WT/DIMS	.066 lbs. / 6.687" x 1.5" x 1.625"
WARRANTY	Three Year Warranty

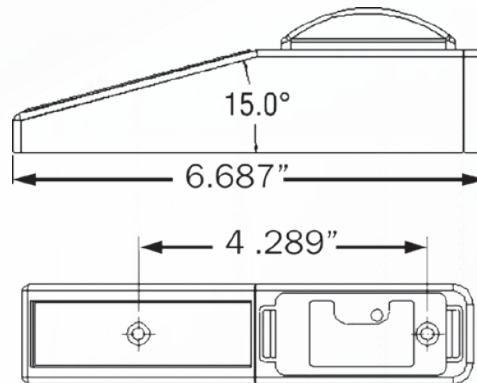

SEALED MARKER/
CLEARANCE LIGHTS



MC65/67 & BA65 SERIES Sealed Fender Lights

- Sonically sealed, waterproof
- PC rated design includes two bulbs
- Multiple mounting and wiring options available
- Single wire design grounds through mounting hardware
- Two-wire design includes both lead and ground wires



MC65ARB

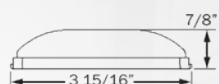
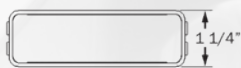

MC67ARB

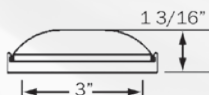
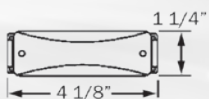

SEALED MARKER/
CLEARANCE LIGHTS

BULK P/N	POLYPACK P/N	DESCRIPTION	QTY
		AMBER/RED FENDER LIGHT	
MC65ARB	MC65ARBP	Light only	50
MC67ARB	MC67ARBP	Kit: MC65ARB & A65PB bracket/plug	50
		AMBER/RED FENDER LIGHT ASSEMBLIES	
BA65ARLB	BA65ARLBP	Fender light assembly, left side: MC65AB & MC65RB in fender mount bracket	25
BA65ARRB	BA65ARRBP	Fender light assembly, right side: MC65AB & MC65RB in fender mount bracket	25
ACCESSORIES			
A67BB	A67BBP	Fender bracket, black	50
A65B	A65BP	Black bracket	50
A65P	A65PP	Single wire plug, .156 male bullet	50
A65PB	A65PBP	Kit: A65B black bracket & A65P plug	50
A66PB	A66PBP	Kit: Gray bracket & A65P plug	50
A67CB	A67CBP	Kit: Chrome bracket & A65P plug	50
A68PB	A68PBP	Kit: Black bracket & 2-wire plug	50

For more details on mounting and wiring accessories, see Accessories section at back of catalog.



BA65ARLB

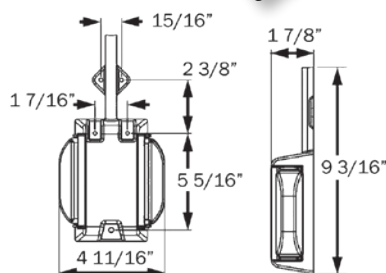

FMVSS	MC65ARB: P2
	BA65: P2 P3 PC2
MATERIALS	MC65: Polycarbonate lens and housing
	BA65: Polycarbonate lens and housing, plastic bracket
VOLT/AMP	MC65: 12.8VDC - 0.689A
	BA65: 12.8VDC - 0.8A
WT/DIMS	MC65: .066 lbs. / 3.938" x 1.25" x .875"
	BA65: .375 lbs. / 9.188" x 4.688" x 1.875"
WARRANTY	Three Year Warranty

MC65/67 SERIES Sealed Marker/Clearance Lights

- Sonically sealed, waterproof
- PC rated design includes two bulbs
- Multiple mounting and wiring options available
- Single wire design grounds through mounting hardware
- Two-wire design includes both lead and ground wires



BULK P/N	POLYPACK P/N	DESCRIPTION	QTY
YELLOW			
MC65AB	MC65ABP	Light only	50
MC67AB	MC67ABP	Kit: MC65AB & A65PB	50
RED			
MC65RB	MC65RBP	Light only	50
MC67RB	MC67RBP	Kit: MC65RB & A65PB	50
ACCESSORIES			
A65B	A65BP	Black bracket	50
A65P	A65PP	Single wire plug, .156 male bullet	50
A65PB	A65PBP	Kit: A65B black bracket & A65P plug	50
A66PB	A66PBP	Kit: Gray bracket & A65P plug	50
A67CB	A67CBP	Kit: Chrome bracket & A65P plug	50
A68PB	A68PBP	Kit: Black bracket & 2-wire plug	50
For more details on mounting and wiring accessories, see Accessories section at back of catalog.			
RETAIL			
MC67AK		Yellow kit: MC65AB & A65PB, clam	12
MC67RK		Red kit: MC65RB & A65PB, clam	12
MC65AS		Yellow light, clam	12
MC65RS		Red light, clam	12

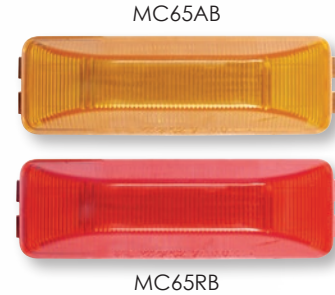

SEALED MARKER/
CLEARANCE LIGHTS



FMVSS	P2 P3 PC2
MATERIALS	Polycarbonate lens and housing
VOLT/AMP	12.8VDC - 0.4A
WT/DIMS	.066 lbs. / 3.938" x 1.25" x .875"
WARRANTY	Three Year Warranty

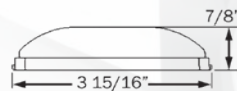
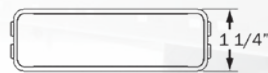

MC65

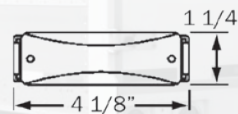

MC67



1 3/32"

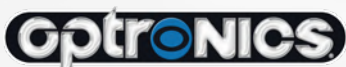

MC91 SERIES

Sealed Marker/Clearance Lights



- Sonically sealed, waterproof
- PC rated design
- Multiple mounting and wiring options available
- Single wire design grounds through mounting hardware
- Two-wire design includes both lead and ground wires

SEALED MARKER/
CLEARANCE LIGHTS



A91AB
MC90AS



A91RB
MC90RS



MC91AB
MC91AS



MC91RS



MC92AB
MC92AS



MC92RB
MC92RS

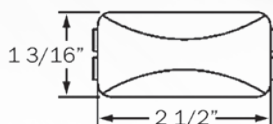

A91
light only

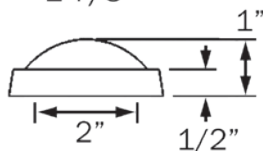
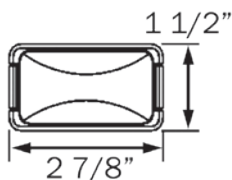

MC90/91/92
kits

BULK P/N	POLYPACK P/N	DESCRIPTION	QTY
YELLOW			
A91AB	A91ABP	Light only	100
MC91AB	MC91ABP	Kit: A91AB, A91CB & A91LW	50
MC92AB	MC92ABP	Kit: A91AB, A91BB & A91LW	50
RED			
A91RB	A91RBP	Light only	100
MC92RB	MC92RBP	Kit: A91RB, A91BB & A91LW	50
ACCESSORIES			
A46PB	A46PBP	2-wire plug, 6" lead	100
A86PB	A86PBP	2-wire plug, 18" lead	100
A90CB	A90CBP	Chrome snap-on cover	100
A91LW	A91LWP	1-wire plug, 12" lead	100
A91BB	A91BBP	Black base, self grounding	100
A91BOB	A91BOBP	Black base, open back	100
A91CB	A91CBP	Chrome base, self grounding	100
A91OB	A91OBP	Chrome base, open back	100
A91GB	A91GBP	Grommet	100

RETAIL			
MC90AS		Yellow light only, clam	12
MC90RS		Red light only, clam	12
MC91AS		Yellow light kit: A91AB, A91CB chrome base, A91LW single wire plug, clam	12
MC91RS		Red light kit: A91RB, A91CB chrome base, A91LW single wire plug, clam	12
MC92AS		Yellow light kit: A91AB, A91BB black base, A91LW single wire plug, clam	12
MC92RS		Red light kit: A91RB, A91BB black base, A91LW single wire plug, clam	12

FMVSS	P2 PC
MATERIALS	Polycarbonate lens and housing
VOLT/AMP	12.8VDC - 0.2A
WT/DIMS	.066 lbs. / 2.5" x 1.188" x .875"
WARRANTY	Three Year Warranty

MC11 SERIES Mini Marker/Clearance Lights

- Surface mount on 2-3/4" centers
- Single wire design grounds through mounting hardware
- Snap-on lens, replaceable bulb

BULK P/N	POLYPACK P/N	DESCRIPTION	QTY
YELLOW			
MC11AB	MC11ABP	Yellow, black base	50
RED			
MC11RB	MC11RBP	Red, black base	50
ACCESSORIES			
A11AB	A11ABP	Yellow replacement lens	50
A11RB	A11RBP	Red replacement lens	50
A194B	A194BP	194 replacement bulb	100
RETAIL			
MC11AS		Yellow light, clam	12
MC11RS		Red light, clam	12
MC11AK		(6) MC11AB, hardware, connectors, clam	6
UL11BS		Blue utility light, clam	12

FMVSS	P2 (except UL11BS)
MATERIALS	Acrylic lens, ABS housing
VOLT/AMP	12.8VDC - 0.4A
WT/DIMS	.044 lbs. / 3.188" x 1" x 1.125"
WARRANTY	Three Year Warranty

GptrONICS

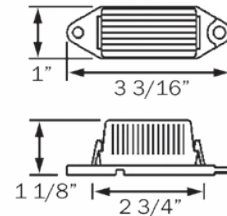

SURFACE MOUNT
MARKER/CLEARANCE LIGHTS

MC30 SERIES Marker/Clearance Light with Reflex

- Surface mount on 2" centers
- Plug-n-go design for quick connection to power and ground
- Snap-on lens, replaceable bulb

BULK P/N	POLYPACK P/N	DESCRIPTION	QTY
YELLOW			
MC30AB	MC30ABP	Yellow	20
ACCESSORIES			
A194B	A194BP	194 replacement bulb	100

FMVSS	A P2 PC
MATERIALS	Acrylic lens, ABS housing
VOLT/AMP	12.8VDC - 0.2A
WT/DIMS	.11 lb. / 3" x 2.25" x .938"
WARRANTY	Three Year Warranty

GptrONICS

PC Rated

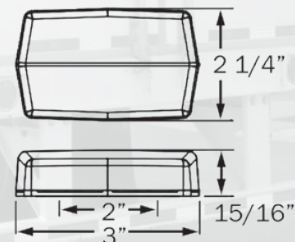



MC21/22 SERIES Beehive Marker/Clearance Lights

- Surface mount on 3/4" centers
- Single wire design grounds through mounting hardware
- Snap-on lens, replaceable bulb



MC22AB

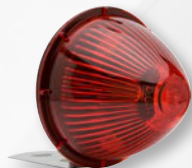

MC22RB



MC21AS

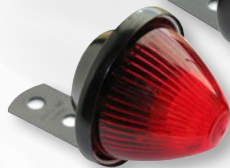

MC21RS

SURFACE MOUNT
MARKER/CLEARANCE LIGHTS

BULK P/N	POLYPACK P/N	DESCRIPTION	QTY
YELLOW			
MC22AB	MC22ABP	Yellow	50
RED			
MC22RB	MC22RBP	Red	50
ACCESSORIES			
A21AB	A21ABP	Yellow replacement lens for MC21	50
A21RB	A21RBP	Red replacement lens for MC21	50
RETAIL			
MC21AS		Yellow light, clam	12
MC21RS		Red light, clam	12

FMVSS	P2 PC
MATERIALS	Acrylic lens, steel bracket
VOLT/AMP	12.8VDC - 0.4A
WT/DIMS	MC22: .176 lbs. / 2.563" x 2.563" x 3.688" MC21: .176 lbs. / 2.563" x 2.563" x 4.063"
WARRANTY	Three Year Warranty

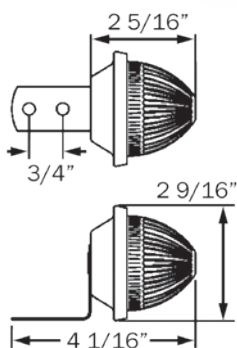

MC21

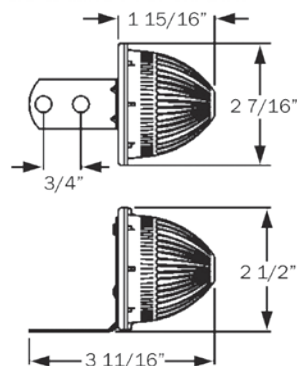

MC22

MC31/32 SERIES

Surface Mount Marker/Clearance Lights with Reflex

- Surface mount on 3" centers
- Lens with reflex eliminates need for separate reflector
- MC31 is single wire design, grounds through mounting hardware
- MC32 has twist-in socket with separate ground wire
- Snap-on lens, replaceable 194 bulb

BULK P/N	POLYPACK P/N	DESCRIPTION	QTY
YELLOW			
MC31AB	MC31ABP	Oval, black base, single wire	50
MC31A15B2	MC31A15B2P	MC31AB with .156 female barrels	50
MC32AB	MC32ABP	Oblong, white base, two-wire	100
MC32ABB	MC32ABBP	Oblong, black base, two-wire	100
RED			
MC31RB	MC31RBP	Oval, black base, single wire	50
MC31R15B2	MC31R15B2P	MC31RB with .156 female barrels	50
MC32RB	MC32RBP	Oblong, white base, two-wire	100
MC32RBB	MC32RBBP	Oblong, black base, two-wire	100
ACCESSORIES			
A31AB	A31ABP	Yellow replacement lens, MC31	50
A31RB	A31RBP	Red replacement lens, MC31	50
A32AB	A32ABP	Yellow replacement lens, MC32	50/10
A32RB	A32RBP	Red replacement lens, MC32	50/10
A32GB	A32GBP	Mounting gasket, white	500
A194B	A194BP	194 replacement bulb	100
RETAIL			
MC31AS		MC31AB, clam	12
MC31RS		MC31RB, clam	12
MC32AS	MC32AB, clam	12	
MC32ABS	MC32ABB, clam	12	
MC32RS	MC32RB, clam	12	
MC32RBS	MC32RBB, clam	12	

FMVSS	A P2
MATERIALS	Acrylic lens, ABS housing
VOLT/AMP	12.8VDC - 0.2A
WT/DIMS	MC31: .088 lb. / 4" x 2.063" x 1.094" MC32: .11 lb. / 4" x 2" x 1.125"
WARRANTY	Three Year Warranty

OpTRONICS



MC31AB



MC31RB

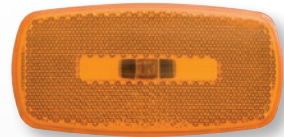
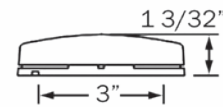
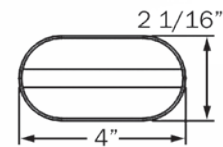

MC32AB



MC32RB

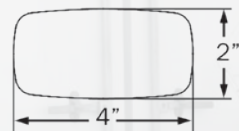

A32GB

SURFACE MOUNT
MARKER/CLEARANCE LIGHTS



MC35/36 SERIES

Surface Mount Marker/Clearance Lights with Reflex

- Surface mount lights; choose from ear mount or stud mount versions
- Lens with reflex eliminates need for separate reflector
- MC35 is ear mount version
- MC36 is stud mount version
- Single wire design grounds through mounting hardware
- Screw-on lens, replaceable bulb, black plastic base

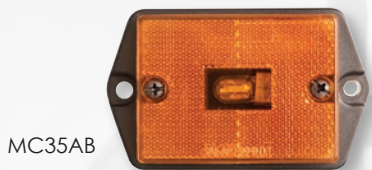

MC35AB



MC35AEB



MC36AB

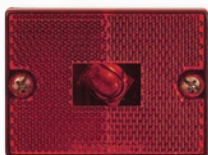

MC36RB

SURFACE MOUNT MARKER/CLEARANCE LIGHTS

BULK P/N	POLYPACK P/N	DESCRIPTION	QTY
YELLOW			
MC35AB	MC35ABP	Yellow ear mount	50
MC35AEB	MC35AEBP	Yellow ear mount, rectangular	200
MC36AB	MC36ABP	Yellow stud mount	50
RED			
MC36RB	MC36RBP	Red stud mount	50
ACCESSORIES			
A35AEB	A35AEBP	Yellow replacement lens	50
A36AB	A36ABP	Yellow replacement lens	50
A36RB	A36RBP	Red replacement lens	50
A194B	A194BP	194 replacement bulb	100
RETAIL			
MC35AS	Retail Ready	Yellow ear mount light, clam	12
MC36AS		Yellow stud mount light, clam	12
MC36AS6		Yellow stud mount light, clam	6
MC36RS		Red stud mount light, clam	12
MC36RS6		Red stud mount light, clam	6

FMVSS	A P2
MATERIALS	Acrylic lens, ABS housing
VOLT/AMP	12.8VDC - 0.2A
WT/DIMS	MC35: .132 lb. / 3.875" x 2.375" x 1.094" MC35AEB: .132 lb. / 3.75" x 2.063" x .938" MC36: .132 lb. / 2.75" x 2.125" x 1"
WARRANTY	Three Year Warranty

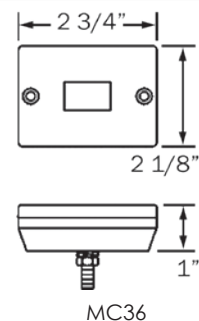
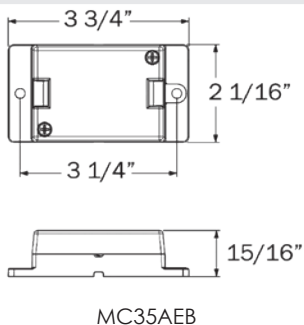
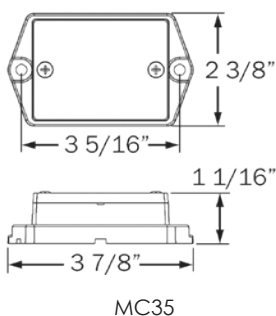

MC37 SERIES

Stud Mount Marker/Clearance Light with Reflex

- Stud mount design; grounds through mounting stud
- Lens with reflex eliminates need for separate reflector
- Replaceable bulb
- Polycarbonate lens and housing

BULK P/N	POLYPACK P/N	DESCRIPTION	QTY
YELLOW			
MC37AB	MC37ABP	Yellow	50
ACCESSORIES			
A194B	A194BP	194 replacement bulb	100

FMVSS	A P2
MATERIALS	Polycarbonate lens and housing
VOLT/AMP	12.8VDC - 0.2A
WT/DIMS	.11 lb. / 2.875" x 2.125" x .938"
WARRANTY	Three Year Warranty

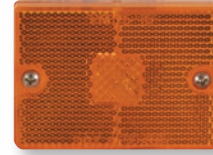

MC37AB

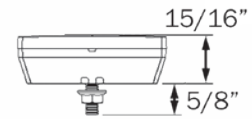
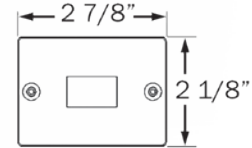

SURFACE MOUNT
MARKER/CLEARANCE LIGHTS

MC38 SERIES

Surface Mount Marker/Clearance Lights with Reflex

- Surface mount on 3" centers
- Lens with reflex eliminates need for separate reflector
- Single wire design grounds through mounting hardware
- Snap-on lens, replaceable bulb

BULK P/N	POLYPACK P/N	DESCRIPTION	QTY
YELLOW			
MC38AB	MC38ABP	Yellow	50
RED			
MC38RB	MC38RBP	Red	50
ACCESSORIES			
A38AB	A38ABP	Yellow replacement lens	50
A38RB	A38RBP	Red replacement lens	50
A194B	A194BP	194 replacement bulb	100

FMVSS	A P2
MATERIALS	Acrylic lens, ABS housing
VOLT/AMP	12.8VDC - 0.2A
WT/DIMS	.11 lb. / 4" x 2.063" x 1.156"
WARRANTY	Three Year Warranty

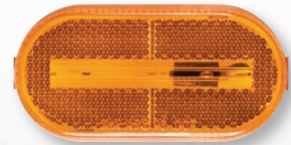

MC38AB



MC38RB

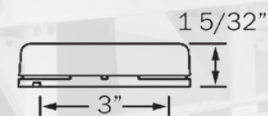
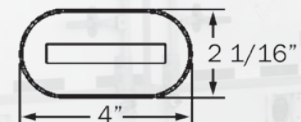

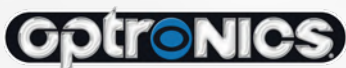

MC42 SERIES

Dual Bulb Marker/Clearance Lights

- Dual bulb, bullseye style lights with black base
- Snap-on lens and replaceable bulbs
- Surface mount on 3" centers
- Single wire design grounds through mounting hardware



MC42AB



MC42RB

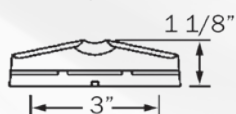

BULK P/N	POLYPACK P/N	DESCRIPTION	QTY
YELLOW			
MC42AB	MC42ABP	Yellow	50
RED			
MC42RB	MC42RBP	Red	50
ACCESSORIES			
A42AB	A42ABP	Yellow replacement lens	10
A42RB	A42RBP	Red replacement lens	10
A194B	A194BP	194 replacement bulb	100
RETAIL			
MC42AS		Yellow light, clam	12
MC42RS		Red light, clam	12
FMVSS	P2		
MATERIALS	Acrylic lens, ABS housing		
VOLT/AMP	12.8VDC - 0.4A		
WT/DIMS	.088 lb. / 4.094" x 2.125" x 1.125"		
WARRANTY	Three Year Warranty		

SURFACE MOUNT
MARKER/CLEARANCE LIGHTS



MC48 SERIES

Marker/Clearance Lights with Reflex

- Flush mount on 3-3/8" centers
- Lens with reflex eliminates need for separate reflector
- Twist-in socket with replaceable bulb and ground wire

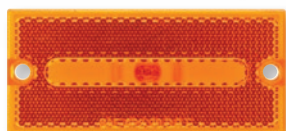

MC48AB/APG

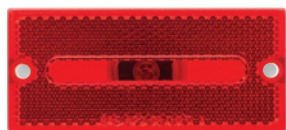

MC48RB/RPG

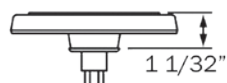
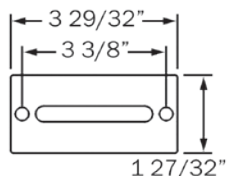

BULK P/N	POLYPACK P/N	DESCRIPTION	QTY
YELLOW			
MC48AB	MC48ABP	Yellow	50
MC48APG	MC48APGP	Yellow with .156 female barrels	50
RED			
MC48RB	MC48RBP	Red	50
MC48RPG	MC48RPGP	Red with .156 female barrels	50
ACCESSORIES			
A194B	A194BP	194 replacement bulb	100
FMVSS	A P2		
MATERIALS	Acrylic lens, ABS housing		
VOLT/AMP	12.8VDC - 0.2A		
WT/DIMS	.132 lb. / 3.906" x 1.843" x 1.031"		
WARRANTY	Three Year Warranty		

MC44 & BA44 SERIES Surface Mount Marker/Clearance Lights with Reflex

- Surface mount on 3" centers
- Lens with reflex eliminates need for separate reflector
- Two-wire design includes both lead and ground wire
- Snap-on lens, replaceable bulb
- Fender light assembly includes one each MC44AB and MC44RB in black ABS bracket; female plug on power wire, grounding eyelet on ground wire

BULK P/N	POLYPACK P/N	DESCRIPTION	QTY
YELLOW			
MC44AB	MC44ABP	Yellow, two-wire	50
MC44AB1	MC44AB1P	Yellow, single wire	50
RED			
MC44RB	MC44RBP	Red, two-wire	50
MC44RB1	MC44RB1P	Red, single wire	50
YELLOW/RED FENDER		LIGHT ASSEMBLY	
BA44FNL	BA44FNLP	Left side	25
BA44FNR	BA44FNRP	Right side	25
ACCESSORIES			
MC441WB	-	Single wire base only	500
MC442WB	-	Two-wire base only	50
A44A500B	-	Yellow replacement lens, 500-pack	500
A44R500B	-	Red replacement lens, 500-pack	500
A44AB	A44ABP	Yellow replacement lens	10
A44RB	A44RBP	Red replacement lens	10
A194B	A194BP	194 replacement bulb	100
A44GTB	-	Mounting gasket, thick, white	1000
RETAIL			
MC44AS		Yellow light, clam	12
MC44RS		Red light, clam	12

FMVSS	A P2
MATERIALS	Acrylic lens, ABS housing
VOLT/AMP	MC44: 12.8VDC - 0.4A BA44: 12.8VDC - 0.8A
WT/DIMS	MC44: .066 lb. / 4" x 1.5" x .938" BA44: .353 lb. / 8.5" x 3.875" x 1.75"
WARRANTY	Three Year Warranty

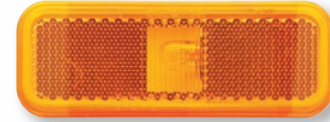

MC44AB



MC44RB



A44GB

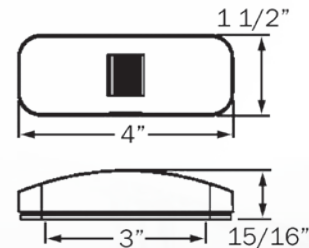

BA44FNR

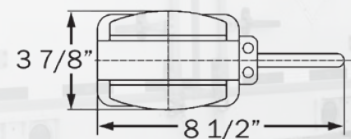

SURFACE MOUNT
MARKER/CLEARANCE LIGHTS



MC58 SERIES 2.5" Marker/Clearance Lights



MC58RS

MC58AS

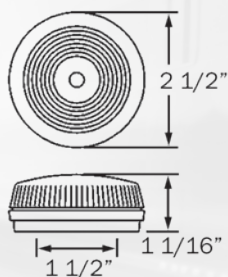

- Surface mount on 1-1/2" centers
- Single wire design grounds through mounting hardware
- Snap-on lens, replaceable bulb

BULK P/N	POLYPACK P/N	DESCRIPTION	QTY
RETAIL			
MC58AS		Yellow light, clam	12
MC58RS		Red light, clam	12
ACCESSORIES			
A194B	A194BP	194 replacement bulb	100

FMVSS	P2
MATERIALS	Acrylic lens, ABS housing
VOLT/AMP	12.8VDC - 0.2A
WT/DIMS	.066 lbs. / 2.5" x 2.5" x 1.063"
WARRANTY	Three Year Warranty

SURFACE MOUNT
MARKER/CLEARANCE LIGHTS

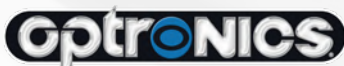

MC66 SERIES Surface Mount Dual Bulb Marker/Clearance Lights



MC66AB



MC66RB

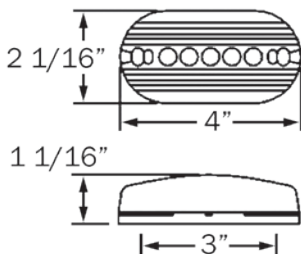

- Surface mount on 3" centers
- Includes both lead and ground wires
- Snap-on lens, replaceable bulb



BULK P/N	POLYPACK P/N	DESCRIPTION	QTY
YELLOW			
MC66AB	MC66ABP	Yellow	50
MC66HAB	MC66HABP	Yellow, single wire, self grounding	50
RED			
MC66RB	MC66RBP	Red	50



ACCESSORIES			
A66AB	A66ABP	Yellow replacement lens	50
A66RB	A66RBP	Red replacement lens	50
A194B	A194BP	194 replacement bulb	100

RETAIL			
MC66AS		Yellow light, clam	12
MC66RS		Red light, clam	12

FMVSS	P2 PC
MATERIALS	Acrylic lens, ABS housing
VOLT/AMP	12.8VDC - 0.4A
WT/DIMS	.132 lb. / 4" x 2.063" x 1.063"
WARRANTY	Three Year Warranty

MC68 SERIES Oblong Marker/Clearance Lights

- Surface mount on 2-3/4" centers
- Single wire design grounds through mounting hardware
- Snap-on lens, replaceable bulb

BULK P/N	POLYPACK P/N	DESCRIPTION	QTY
YELLOW			
MC68AB	MC68ABP	Yellow, self grounding	50
RED			
MC68RB	MC68RBP	Red, self grounding	50
ACCESSORIES			
A68AB	A68ABP	Yellow replacement lens	50
A68RB	A68RBP	Red replacement lens	50
RETAIL			
MC68AS		Yellow light, clam	12
MC68RS		Red light, clam	12
FMVSS	P2		
MATERIALS	Acrylic lens, ABS housing		
VOLT/AMP	12.8VDC - 0.2A		
WT/DIMS	.088 lb. / 3.5" x 1.125" x 1"		
WARRANTY	Three Year Warranty		



MC68AB



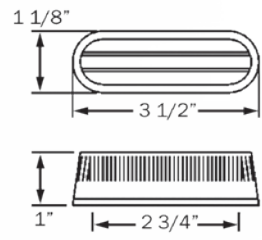

MC68RB



SURFACE MOUNT
MARKER/CLEARANCE LIGHTS

MC70 SERIES Marker/Clearance Lights with Reflex

- Surface mount on 4-13/16" centers
- Lens with reflex eliminates need for separate reflector
- Weathertight plug included

BULK P/N	POLYPACK P/N	DESCRIPTION	QTY
YELLOW			
MC70AB	MC70ABP	Yellow	20
RED			
MC70RB	MC70RBP	Red	20
RETAIL			
MC70AS		Yellow light, clam	6
MC70RS		Red light, clam	6
FMVSS	A P2		
MATERIALS	Acrylic lens, plastic housing		
VOLT/AMP	12.8VDC - 0.422A		
WT/DIMS	.132 lb. / 5.813" x 2" x 1.188"		
WARRANTY	Three Year Warranty		



MC70AB



MC70RB

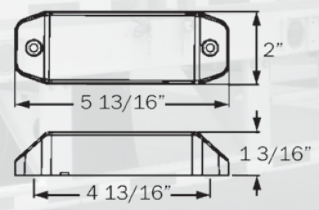



MC71 SERIES Marker/Clearance Lights

- Flush mount on 2" centers; chrome finish bezel
- Twist-in socket, includes both lead and ground wire
- Replaceable bulb



MC71AS



MC71RS

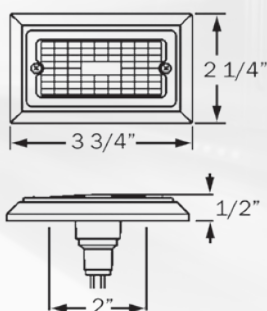

BULK P/N	POLYPACK P/N	DESCRIPTION	QTY
RETAIL			
MC71AS		Yellow light, clam	12
MC71RS		Red light, clam	12
ACCESSORIES			
A194B	A194BP	194 replacement bulb	100

FMVSS	P2
MATERIALS	Acrylic lens, ABS housing and bezel
VOLT/AMP	12.8VDC - 0.4A
WT/DIMS	.132 lb. / 3.75" x 2.25" x 0.5"
WARRANTY	Three Year Warranty

SURFACE MOUNT
MARKER/CLEARANCE LIGHTS



MC76 SERIES Marker/Clearance Light with Reflex

- Dual bulb light with built-in reflex
- Lens with reflex eliminates need for separate reflector
- Surface mount on 4-13/16" centers
- Hard wired, single wire design is self grounding

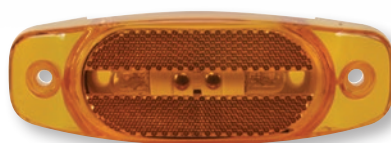

MC76AB

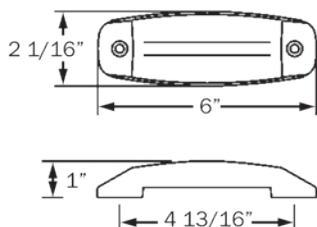

BULK P/N	POLYPACK P/N	DESCRIPTION	QTY
YELLOW			
MC76AB	MC76ABP	Yellow	50
ACCESSORIES			
A194B	A194BP	194 replacement bulb	100

FMVSS	A P2
MATERIALS	Acrylic lens, ABS housing
VOLT/AMP	12.8VDC - 1.0A
WT/DIMS	.132 lb. / 6" x 2.063" x 1"
WARRANTY	Three Year Warranty

MC81 SERIES

Chrome Marker/Clearance Lights

- Surface mount on 3-7/8" centers
- Single wire design grounds through mounting hardware
- Replaceable lens and bulb

BULK P/N	POLYPACK P/N	DESCRIPTION	QTY
YELLOW			
MC81AB	MC81ABP	Yellow, self grounding	50
RED			
MC81RB	MC81RBP	Red, self grounding	50
ACCESSORIES			
A81AB	A81ABP	Yellow replacement lens	50
A81RB	A81RBP	Red replacement lens	50
A194B	A194BP	194 replacement bulb	100

FMVSS	P2
MATERIALS	Acrylic lens, ABS housing
VOLT/AMP	12.8VDC - 0.2A
WT/DIMS	.176 lb. / 4.781" x 2.125" x 1.375"
WARRANTY	Three Year Warranty



MC81AB



MC81RB

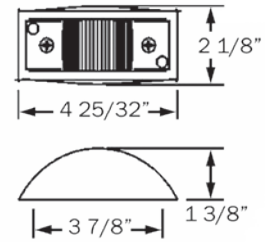

SURFACE MOUNT
MARKER/CLEARANCE LIGHTS

MC82 SERIES

Armored Marker/Clearance Lights

- Surface mount on 3-7/8" centers
- Single wire design grounds through mounting hardware
- Replaceable lens and bulb



BULK P/N	POLYPACK P/N	DESCRIPTION	QTY
YELLOW			
MC82AB	MC82ABP	Yellow	20
RED			
MC82RB	MC82RBP	Red	20
ACCESSORIES			
A82AB	A82ABP	Yellow replacement lens	50
A82RB	A82RBP	Red replacement lens	50
A194B	A194BP	194 replacement bulb	100

FMVSS	P2 PC
MATERIALS	Acrylic lens, steel housing
VOLT/AMP	12.8VDC - 0.2A
WT/DIMS	.441 lb. / 4.5" x 2" x 1.5"
WARRANTY	Three Year Warranty



MC82AB



MC82RB

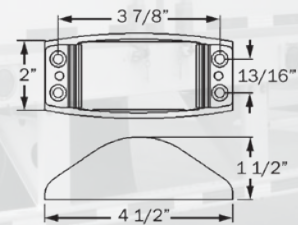



MC95 SERIES Sealed Marker/Clearance Lights

- Sonically sealed, waterproof
- Stainless steel base
- Single wire design grounds through mounting hardware



MC95AB



MC95RB

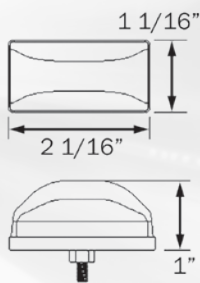

SURFACE MOUNT
MARKER/CLEARANCE LIGHTS

BULK P/N	POLYPACK P/N	DESCRIPTION	QTY
YELLOW			
MC95AB	MC95ABP	Yellow	50
MC95APG	MC95APGP	Yellow, .180 male bullet	50
RED			
MC95RB	MC95RBP	Red	50
RETAIL			
MC95AS		Yellow light, clam	12
MC95RS		Red light, clam	12

FMVSS	P2 P3
MATERIALS	Polycarbonate lens and housing, stainless steel base
VOLT/AMP	12.8VDC - 0.2A
WT/DIMS	.088 lb. / 2.063" x .688" x 1"
WARRANTY	Three Year Warranty

CB11 SERIES Yellow Cab/Clearance Lights

- White and black base models, mounts on 3" centers
- Replaceable lens and bulb (67 bulb)
- Includes both lead and ground wires



BULK P/N	POLYPACK P/N	DESCRIPTION	QTY
CAB/CLEARANCE LIGHT			
CB11WAB	CB11WABP	Yellow, white base	50
CB11AB	CB11ABP	Yellow, black base	50
RETAIL			
CB11AS		Cab light, black base, clam	12
CB11AS6		Cab light, black base, clam	6
CB15AK		5-pc cab light kit, black base, clam	6

FMVSS	P2 PC
MATERIALS	Acrylic lens, ABS housing
VOLT/AMP	12.8VDC - 0.569A
WT/DIMS	CB11: .176 lb. / 5.5" x 2.375" x 1.625" CB15: 1.191 lbs. / 5.5" x 2.375" x 1.625"
WARRANTY	Three Year Warranty

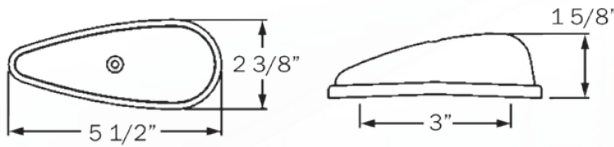

CB11WAB



CB11AS



CB15AK

SURFACE MOUNT
MARKER/CLEARANCE LIGHTS



CB20 SERIES Yellow Cab/Clearance Light

- Surface mount on 1-1/2" centers, gasket included
- Sealed polycarbonate lens and housing
- Includes both lead and ground wires



CB20AB

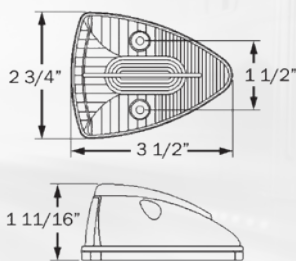

BULK P/N	POLYPACK P/N	DESCRIPTION	QTY
CAB/CLEARANCE LIGHT			
CB20AB	CB20ABP	Yellow	50
RETAIL			
CB20AS		Yellow, clam	12

FMVSS	P2 PC
MATERIALS	Acrylic lens, ABS housing
VOLT/AMP	12.8VDC - 0.2A
WT/DIMS	.265 lb. / 3.5" x 2.75" x 1.688"
WARRANTY	Three Year Warranty

SURFACE MOUNT
MARKER/CLEARANCE LIGHTS



CB22 SERIES Cab/Clearance Lights



- Surface mount on 1-3/4" centers, gasket included
- Sealed polycarbonate lens and housing
- Twist-in socket with both lead and ground wires



CB22AB



CB22RB

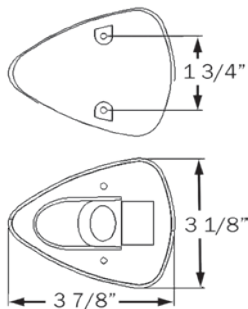

BULK P/N	POLYPACK P/N	DESCRIPTION	QTY
YELLOW			
CB22AB	CB22ABP	Yellow	50
RED			
CB22RB	CB22RBP	Red	50
ACCESSORIES			
A194B	A194BP	194 replacement bulb	100
RETAIL			
CB22AS		Yellow, clam	12

FMVSS	P2 PC
MATERIALS	Polycarbonate lens and housing
VOLT/AMP	12.8VDC - 0.2A
WT/DIMS	.132 lb. / 3.875" x 3.125" x 1.625"
WARRANTY	Three Year Warranty

MC77RB

Identification Light Bar

- Steel base with white finish
- Surface mount on 7" centers
- Snap-on lens and replaceable bulb
- Single wire design, self grounding



MC77RB

BULK P/N	POLYPACK P/N	DESCRIPTION	QTY
RED ID LIGHT BAR			
MC77RB	MC77RBP	ID light bar	20
ACCESSORIES			
A68RB	A68RBP	Red replacement lens	50
FMVSS	P2		
MATERIALS	Acrylic lens, ABS housing, steel base		
VOLT/AMP	12.8VDC - 1.0A (193 bulb)		
WT/DIMS	.265 lb. / 15.563" x 1.188" x 1.313"		
WARRANTY	Three Year Warranty		

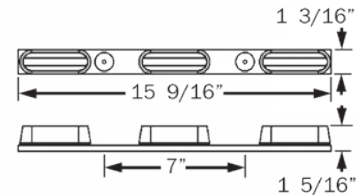

MC93 SERIES

Sealed Identification Light Bars

- Surface mount on 7-1/2" centers
- Sealed, waterproof lights
- Hard wired, power and ground



MC93AB

MC93RB

BULK P/N	POLYPACK P/N	DESCRIPTION	QTY
YELLOW			
MC93AB	MC93ABP	Yellow	20
RED			
MC93RB	MC93RBP	Red	20
MC93RPG	MC93RPGP	Red, .180 male bullet on power wire	20
MC93R2PG	MC93R2PGP	Red, .180 male bullets on both wires	20
ACCESSORIES			
A91AB	A91ABP	Yellow replacement light	100
A91RB	A91RBP	Red replacement light	100
A93PB	A93PBP	Harness for light bar	100
RETAIL			
MC93RK		Red ID light bar, clam	6
FMVSS	P2		
MATERIALS	Polycarbonate lens and housing, ABS base		
VOLT/AMP	12.8VDC - 1.0A		
WT/DIMS	.397 lb. / 17" x 1.438" x 1.625"		
WARRANTY	Three Year Warranty		

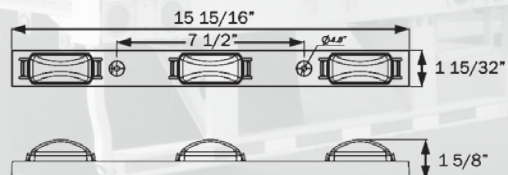

IDENTIFICATION LIGHT BARS



MC94RB

Identification Light Bar



MC94RB

- Stainless steel base
- Surface mount on 16-1/16" centers
- Sealed, waterproof lights
- Hard wired, power and ground

BULK P/N	POLYPACK P/N	DESCRIPTION	QTY
RED ID LIGHT BAR			
MC94RB	MC94RBP	ID light bar	20
ACCESSORIES			
A91RB	A91RBP	Red replacement light	100
A93PB	A93PBP	Harness for light bar	100

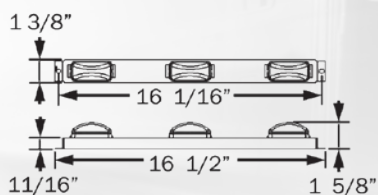

FMVSS	P2
MATERIALS	Polycarbonate lens and housing, stainless steel base
VOLT/AMP	12.8VDC - 1.0A
WT/DIMS	.441 lb. / 16.5" x 1.375" x 1.625"
WARRANTY	Three Year Warranty

IDENTIFICATION LIGHT BARS



MC97 SERIES

Sealed Identification Light Bars



MC97RB

- Stainless steel base
- Surface mount on 8-1/2" centers
- Sealed, waterproof lights
- Single wire, self grounding

BULK P/N	POLYPACK P/N	DESCRIPTION	QTY
RED ID LIGHT BARS			
MC97RB	MC97RBP	Red	20
MC97R70PG	-	Red, .156 female plug, 70" lead	20
CLEAR UTILITY LIGHT			
UL97CPG	UL97CPGP	Clear	50
ACCESSORIES			
MC95RB	MC95RBP	Red replacement light	50
RETAIL			
MC97RK		Red ID light bar, clam	6

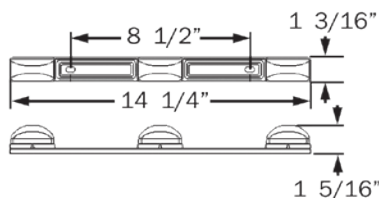

FMVSS	P2
MATERIALS	Polycarbonate lens and housing, stainless steel base
VOLT/AMP	12.8VDC - 1.0A
WT/DIMS	.441 lb. / 14.25" x 1.188" x 1.313"
WARRANTY	Three Year Warranty

MC99 SERIES Identification Light Bars

- Steel base with white finish
- Surface mount on 14-3/8" centers
- Snap-on lens, replaceable bulbs
- Single wire, self grounding



BULK P/N	POLYPACK P/N	DESCRIPTION	QTY
YELLOW			
MC99AB	MC99ABP	Yellow	20
RED			
MC99RB	MC99RBP	Red	20
ACCESSORIES			
A11AB	A11ABP	Yellow replacement lens	50
A11RB	A11RBP	Red replacement lens	50
A194B	A194BP	194 replacement bulb	100
RETAIL			
MC99AK		Yellow ID light bar, clam	6
MC99RK		Red ID light bar, clam	6

FMVSS	P2
MATERIALS	Acrylic lens, ABS housing, steel base
VOLT/AMP	12.8VDC - 1.0A
WT/DIMS	.353 lb. / 15.063" x 1.375" x 1.438"
WARRANTY	Three Year Warranty

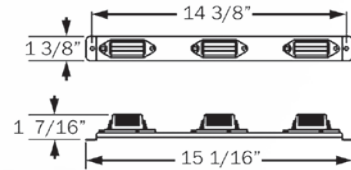

IDENTIFICATION LIGHT BARS



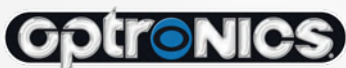

LP11 SERIES Snap-In Mini License Plate Lights



LP11CB

- Chrome plated brass construction
- Easy snap-in mounting
- Replaceable bulb (67)
- Single wire, self grounding

BULK P/N	POLYPACK P/N	DESCRIPTION	QTY
LICENSE LIGHTS			
LP11CB	LP11CBP	License light	50
LP11CPG	LP11CPGP	License light, .180 male bullet	50
RETAIL			
LP11CS		License light, clam	12

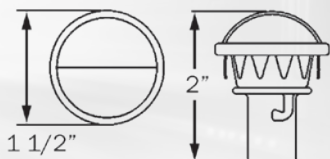

FMVSS	(2) L
MATERIALS	Brass, chrome plated
VOLT/AMP	12.8VDC - 0.4A
WT/DIMS	.066 lb. / 1.5" x 1.5" x 2"
WARRANTY	Three Year Warranty

LICENSE/UTILITY LIGHTS



LP21 SERIES Heavy Duty License Plate Lights



LP21CB

- Armored light made of durable chrome plated steel
- Surface mount on 2" centers
- Replaceable bulb (67)
- Single wire, self grounding

BULK P/N	POLYPACK P/N	DESCRIPTION	QTY
LICENSE LIGHTS			
LP21CB	LP21CBP	License light	50
RETAIL			
LP21CS		License light, clam	12
LP21CS6		License light, clam	6

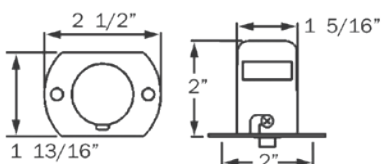

FMVSS	L
MATERIALS	Brass, chrome plated
VOLT/AMP	12.8VDC - 0.2A
WT/DIMS	.132 lb. / 2.5" x 1.813" x 2"
WARRANTY	Three Year Warranty

LP31 SERIES

Mini License Plate Light

- Surface mount on 2" centers
- Replaceable bulb
- Two-wire design includes both lead and ground wire

BULK P/N	POLYPACK P/N	DESCRIPTION	QTY
LICENSE LIGHTS			
LP31CB	LP31CBP	License light	50
LP31CPG	LP31CPGP	License light, .156 female barrels	50
LPB31CPG	LPB31CPGP	License light mounted on black plastic bracket, .156 female barrels	25
ACCESSORIES			
A194B	A194BP	194 replacement bulb	100
RETAIL			
LP31CS		License light, clam	12

FMVSS	(2) L
MATERIALS	Brass, chrome plated bezel; stainless steel bulb socket
VOLT/AMP	12.8VDC - 0.261A
WT/DIMS	.088 lb. / 2.563" x 1.25" x 1" (light only)
WARRANTY	Three Year Warranty



LP31CB



LPB31CPG

LICENSE/UTILITY LIGHTS

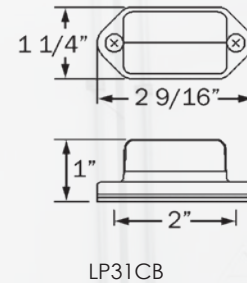
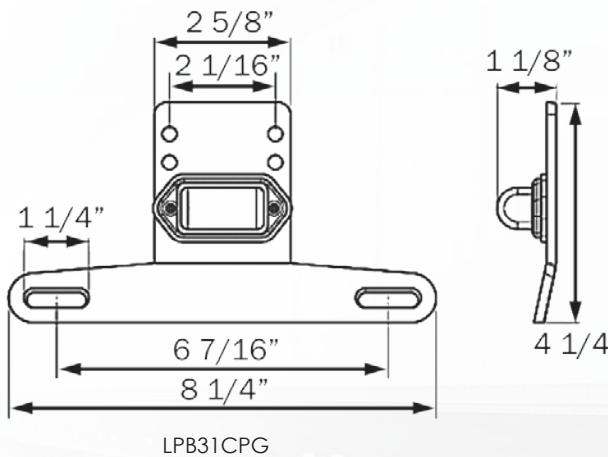





LP41 SERIES Stud Mount License Plate Light

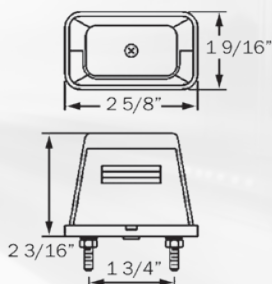

LP41CB



- Chrome plated cover, black base
- Stud mount on 1-3/4" centers
- Replaceable bulb
- Single wire, self grounding

BULK P/N	POLYPACK P/N	DESCRIPTION	QTY
LICENSE LIGHTS			
LP41CB	LP41CBP	License light	50
ACCESSORIES			
A194B	A194BP	194 replacement bulb	100
RETAIL			
LP41CS		License light, clam	12
LP41CS6		License light, clam	6
FMVSS	L		
MATERIALS	Brass, chrome plated		
VOLT/AMP	12.8VDC - 0.2A		
WT/DIMS	.11 lb. / 2.625" x 1.563" x 2.188"		
WARRANTY	Three Year Warranty		

LICENSE/UTILITY LIGHTS



LP51 SERIES Surface Mount License Plate Light



LP51CB

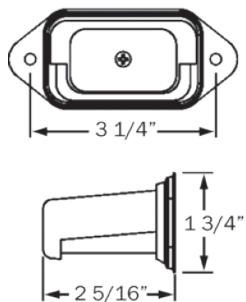

- Gray coated cover, stainless steel mounting base
- Stud mount on 3-1/4" centers
- Replaceable bulb
- Single wire, self grounding

BULK P/N	POLYPACK P/N	DESCRIPTION	QTY
LICENSE LIGHTS			
LP51CB	LP51CBP	License light	20
ACCESSORIES			
A194B	A194BP	194 replacement bulb	100
FMVSS	L		
MATERIALS	Stainless steel mounting base, plastic cover		
VOLT/AMP	12.8VDC - 0.2A		
WT/DIMS	.309 lb. / 4" x 1.75" x 2.313"		
WARRANTY	Three Year Warranty		

LP52/54 SERIES

License Plate Light with Bracket

- Light features gray coated cover, stainless steel mounting base; bracket is steel with black finish
- Surface mount on 3.5" centers, hardware included
- Replaceable bulb

BULK P/N	POLYPACK P/N	DESCRIPTION	QTY
LICENSE LIGHTS			
LP52CB	LP52CBP	License light, single wire	10
LP54CB	LP54CBP	License light, two-wire	10
ACCESSORIES			
LP52HP	LP52HPP	Mounting hardware	100
A194B	A194BP	194 replacement bulb	100

FMVSS	L
MATERIALS	Stainless steel mounting base, plastic cover, steel bracket
VOLT/AMP	12.8VDC - 0.2A
WT/DIMS	.309 lb. / 8.5" x 2.875" x 2.375"
WARRANTY	Three Year Warranty

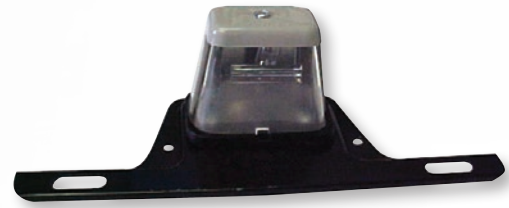

LP52CB

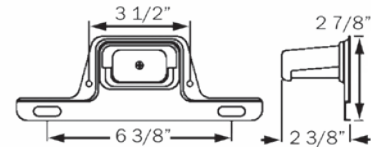

LICENSE/UTILITY LIGHTS

LP55 SERIES

License Plate Light with Bracket

- Light features gray coated cover, stainless steel mounting base; bracket is black heavy duty plastic
- Surface mount on 6-7/16" centers
- Includes both lead and ground wires
- Replaceable bulb (67)

BULK P/N	POLYPACK P/N	DESCRIPTION	QTY
LICENSE LIGHTS			
LP55CB	LP55CBP	License light	10

FMVSS	L
MATERIALS	Stainless steel mounting base, plastic cover, plastic bracket
VOLT/AMP	12.8VDC - 0.2A
WT/DIMS	.176 lb. / 8.625" x 3.25" x 2.313"
WARRANTY	Three Year Warranty



LP55CB

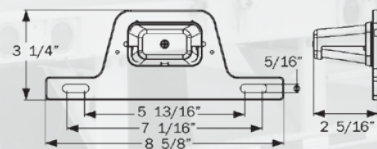



LP56 SERIES

Surface Mount License Plate Light



LP56CB

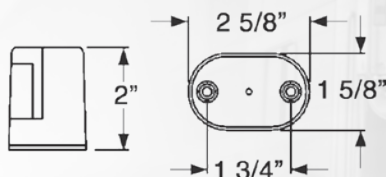

- Surface mount with included adhesive
- Replaceable bulb (67)
- Single wire, self grounding

BULK P/N	POLYPACK P/N	DESCRIPTION	QTY
LICENSE LIGHTS			
LP56CB	LP56CBP	License light	50
FMVSS	L		
MATERIALS	Gray plastic housing		
VOLT/AMP	12.8VDC - 0.2A		
WT/DIMS	.11 lb. / 2.625" x 1.625" x 2"		
WARRANTY	Three Year Warranty		

LICENSE/UTILITY LIGHTS

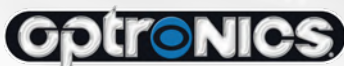

LP65 SERIES

Sealed License Plate Light



LP65CB



LP65CS

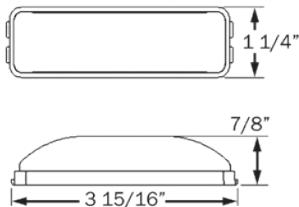

- Sonically sealed, waterproof
- Multiple mounting and wiring options

BULK P/N	POLYPACK P/N	DESCRIPTION	QTY
LICENSE LIGHTS			
LP65CB	LP65CBP	License light	50
ACCESSORIES			
A65B	A65BP	Black bracket	50
A65P	A65PP	Single wire plug, .156 male bullet	50
A65PB	A65PBP	Kit: A65B black bracket & A65P plug	50
A66PB	A66PBP	Kit: Gray bracket & A65P plug	50
A67CB	A67CBP	Kit: Chrome bracket & A65P plug	50
A68PB	A68PBP	Kit: Black bracket & 2-wire plug	50

For more details on mounting and wiring accessories, see Accessories section at back of catalog.

RETAIL

LP65CS		License light, clam	12
FMVSS	L		
MATERIALS	Polycarbonate lens and housing		
VOLT/AMP	12.8VDC - 0.656A		
WT/DIMS	.066 lb. / 3.938" x 1.25" x 0.875"		
WARRANTY	Three Year Warranty		

LP71 SERIES Chrome License Plate Light

- Chrome-plated brass and steel housing
- Mount on 2-5/8" centers
- Replaceable bulb (67)
- Single wire, self grounding
- Two units required for legal license illumination

BULK P/N	POLYPACK P/N	DESCRIPTION	QTY
LICENSE LIGHTS			
LP71CB	LP71CBP	License light	25
RETAIL			
LP71CS		License light, clam	12

FMVSS	(2) L
MATERIALS	Brass and stainless steel housing
VOLT/AMP	12.8VDC - 0.2A
WT/DIMS	.058 lb. / 3.375" x 2.375" x 2.188"
WARRANTY	Three Year Warranty



LP71CB

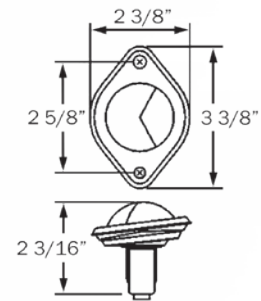

LICENSE/UTILITY LIGHTS

LP81 SERIES Surface Mount License Plate Light

- Surface mount on 3-7/16" centers
- Replaceable bulb
- Includes both lead and ground wires
- Available in standard black and optional gray color

BULK P/N	POLYPACK P/N	DESCRIPTION	QTY
LICENSE LIGHTS			
LP81BB	LP81BBP	License light, black housing	50
LP81BPG	-	License light, black housing, .180 male plug on power, eyelet on ground	50
LP81GB	-	License light, grey housing	50
ACCESSORIES			
A194B	A194BP	194 replacement bulb	100

FMVSS	L
MATERIALS	Polycarbonate housing
VOLT/AMP	12.8VDC - 0.2A
WT/DIMS	.11 lb. / 4" x 1.563" x 2.625"
WARRANTY	Three Year Warranty



LP81BB

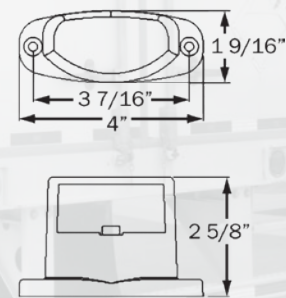



LP97 SERIES Sealed License/Utility Light



LP97CB

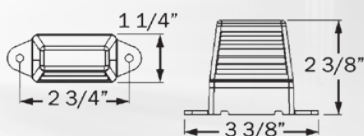

- Sonically sealed, waterproof
- Terminal is two .156 female barrels

BULK P/N	POLYPACK P/N	DESCRIPTION	QTY
LICENSE LIGHTS			
LP97CB	LP97CBP	License light	50
ACCESSORIES			
A46PB	A46PBP	Straight PL-10 plug, 6" lead	100
A86PB	A86PBP	Straight PL-10 plug, 18" lead	100
FMVSS	L		
MATERIALS	Polycarbonate lens and housing		
VOLT/AMP	12.8VDC - 0.2A		
WT/DIMS	.11 lb. / 3.375" x 1.25" x 2.375"		
WARRANTY	Three Year Warranty		

LICENSE/UTILITY LIGHTS



LP95CBF Sealed Stud Mount License/Utility Light



LP95CBF

- Sonically sealed, waterproof
- Design includes both lead and ground wires with .180 female barrels

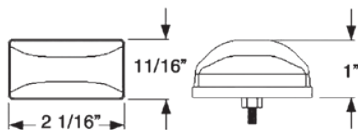

BULK P/N	POLYPACK P/N	DESCRIPTION	QTY
LICENSE/UTILITY LIGHTS			
LP95CBF	-	License/utility light	50

MATERIALS	Polycarbonate lens and housing, stainless steel base		
VOLT/AMP	12.8VDC - 0.2A		
WT/DIMS	.066 lb. / 2.063" x .688" x 1"		
WARRANTY	Three Year Warranty		

LP91 SERIES

Sealed License/Utility Light

- Sonically sealed, waterproof
- Multiple mounting and wiring options

BULK P/N	POLYPACK P/N	DESCRIPTION	QTY
LICENSE/UTILITY LIGHTS			
LP91CB	LP91CBP	License/utility light	50
LP26SKB	LP26SKBP	Kit: LP91CB, LP25SGGB, gasket, .180 male bullets on power and ground	50
LICENSE LIGHT BRACKET			
LP25SB	LP25SBP	Vertical bracket, black coated	100
ACCESSORIES			
A25GB	A25GBP	Gasket	100
A46PB	A46PBP	2-wire plug, 6" lead	100
A86PB	A86PBP	2-wire plug, 18" lead	100
A91LW	A91LWP	1-wire plug, 12" lead	100
A91BB	A91BBP	Black base, self grounding	100
A91BOB	A91BOBP	Black base, open back	100
A91CB	A91CBP	Chrome base, self grounding	100
A91OB	A91OBP	Chrome base, open back	100
A91GB	A91GBP	Grommet	100
LP25SB	LP25SBP	Black vertical bracket	100
LP25SGGB	LP25SGGBP	Grey vertical bracket	100
RETAIL			
LP91CS		License light, clam	12
MATERIALS	Polycarbonate lens and housing		
VOLT/AMP	12.8VDC - 0.2A		
WT/DIMS	.066 lb. / 2.5" x 1.1885" x 0.875"		
WARRANTY	Three Year Warranty		



LP91CB

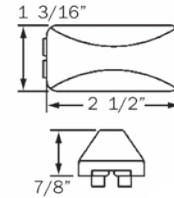

LP26SKB

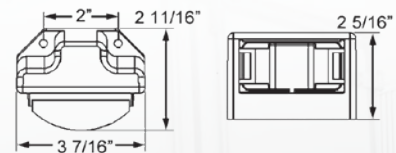

LICENSE/UTILITY LIGHTS



UL94 SERIES

Sealed Stud Mount License/Utility Light



UL94CB

- Sonically sealed, waterproof
- Polycarbonate housing, stainless steel base, clear lens
- Single wire design grounds through mounting hardware

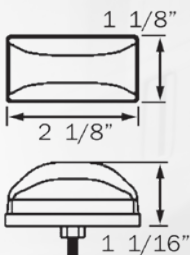

BULK P/N	POLYPACK P/N	DESCRIPTION	QTY
LICENSE/UTILITY LIGHT			
UL94CB	UL94CBP	License/utility light	50

MATERIALS	Polycarbonate lens and housing, stainless steel base
VOLT/AMP	12.8VDC - 0.2A
WT/DIMS	.088 lb. / 2.125" x 1.125" x 1.063"
WARRANTY	Three Year Warranty

UL53 SERIES 2" Sealed Utility Light

- Sonically sealed, waterproof
- Accepts standard two-pin PL-10 plug

BULK P/N	POLYPACK P/N	DESCRIPTION	QTY
UTILITY LIGHT			
UL53CB	UL53CBP	Utility light	100/50
ACCESSORIES			
A46PB	A46PBP	Straight plug, 6" lead	100
A86PB	A86PBP	Straight plug, 18" lead	100
A54GB	A54GBP	2" Flush mount grommet	100
A54GK	A54GKP	2" Kit: A54GB and A46PB	100
A55CB	A55CBP	2" Chrome trim ring	20
BK5557GB	BK5557GBP	Cam-on mounting bracket	50

MATERIALS	Polycarbonate lens and housing
VOLT/AMP	12.8VDC - 0.6A
WT/DIMS	.044 lb. / 2" x 2" x .688"
WARRANTY	Three Year Warranty

optronics



UL53CB

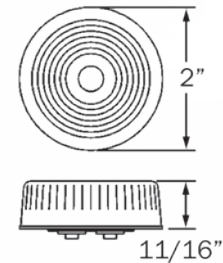

UTILITY/INTERIOR LIGHTS

UL56 SERIES 2.5" Sealed Utility Light

- Sonically sealed, waterproof
- Accepts standard two-pin PL-10 plug
- Flush mount design with flange sealed to light

BULK P/N	POLYPACK P/N	DESCRIPTION	QTY
UTILITY LIGHT			
UL56CB	UL56CBP	Utility light	100/50
ACCESSORIES			
A46PB	A46PBP	Straight plug, 6" lead	100
A86PB	A86PBP	Straight plug, 18" lead	100

MATERIALS	Polycarbonate lens and housing
VOLT/AMP	12.8VDC - 0.6A
WT/DIMS	.044 lb. / 3.438" x 3.438" x .0938"
WARRANTY	Three Year Warranty

optronics



UL56CB

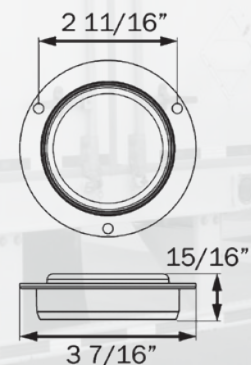

optronics



UL97 SERIES Sealed Utility Light Bar



UL97CPG

- Sonically sealed, waterproof
- Polycarbonate lens and housing, stainless steel base
- Single wire design grounds through mounting hardware
- Plug-n-go connector

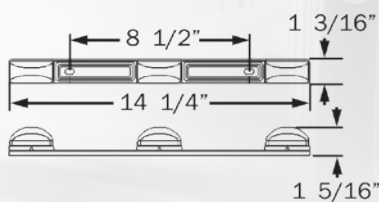

BULK P/N	POLYPACK P/N	DESCRIPTION	QTY
UTILITY LIGHT			
UL97CPG	UL97CPGP	Utility light bar	50

MATERIALS	Polycarbonate lens and housing, stainless steel base
VOLT/AMP	12.8VDC - 0.4A
WT/DIMS	.265 lb. / 14.25" x 1.188" x 1.313"
WARRANTY	Three Year Warranty

UTILITY/INTERIOR LIGHTS

IL21 SERIES

Interior Dome Light

- Surface mount dome light with or without on/off switch
- Mounts on 3-1/2" centers
- Includes both lead and ground wire
- Replaceable bulb (1156)

BULK P/N	POLYPACK P/N	DESCRIPTION	QTY
INTERIOR LIGHTS			
IL21CB	IL21CBP	Interior light with switch, two-wire	50
IL21CPG	-	Interior light with switch, single wire with .180 male bullet	50
RETAIL			
IL21CS		Interior dome light with switch, clam	12
IL21CS6		Interior dome light with switch, clam	6

MATERIALS	Polycarbonate lens, steel base plate
VOLT/AMP	12.8VDC - 2.4A
WT/DIMS	.309 lb. / 4.563" x 2.5" x 1.75"
WARRANTY	Three Year Warranty

optronics



IL21CB

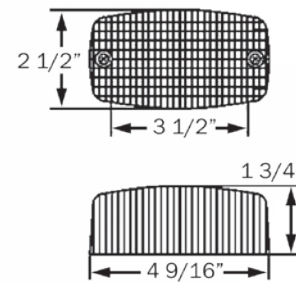

UTILITY/INTERIOR LIGHTS

IL31CS

Porch or Cabin Light

- Surface mount light with on/off switch
- Aluminum base, durable plastic lens
- Single wire design grounds through mounting hardware
- Replaceable bulb (1156)

BULK P/N	POLYPACK P/N	DESCRIPTION	QTY
RETAIL			
IL31CS		Porch/cabin light, clam	6

MATERIALS	Plastic lens, aluminum housing
VOLT/AMP	12.8VDC - 2.2A
WT/DIMS	.375 lb. / 5.125" x 5.125" x 1.813"
WARRANTY	Three Year Warranty

optronics



IL31CS

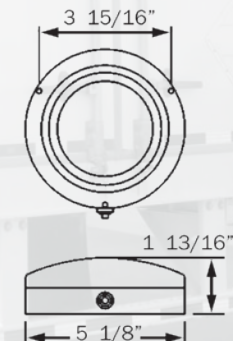



IL61 SERIES Dome Light with Switch



IL61CB

- Surface mount light with on/off switch
- Aluminum base, durable plastic lens
- Single wire design grounds through mounting hardware
- Replaceable bulb (1141)

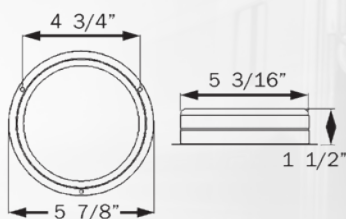

BULK P/N	POLYPACK P/N	DESCRIPTION	QTY
DOMELIGHT			
IL61CB	IL61CBP	Dome light	50

MATERIALS	Plastic lens, aluminum housing
VOLT/AMP	12.8VDC - 0.4A
WT/DIMS	.221 lb. / 5.875" x 5.875" x 1.5"
WARRANTY	Three Year Warranty

UTILITY/INTERIOR LIGHTS

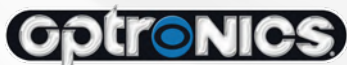

IL91 SERIES 6" Steel Dome Light



IL91CB

- Surface mount steel base, chrome plated
- Includes both lead and ground wires
- Replaceable bulb (1141)

BULK P/N	POLYPACK P/N	DESCRIPTION	QTY
DOMELIGHT			
IL91CB	IL91CBP	Dome light	50

MATERIALS	Polycarbonate lens, steel housing
VOLT/AMP	12.8VDC - 0.4A
WT/DIMS	.485 lb. / 6.438" x 6.438" x 1.75"
WARRANTY	Three Year Warranty

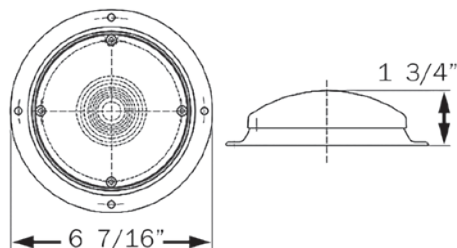

QH16CTS & QH36CTS 55W Halogen Area Lights

- Area lights with post mount bases
- 12V 35W H3 halogen bulb
- Include both lead and ground wires
- QH36CTS has multi-directional bracket that adjusts both horizontally and vertically and stainless steel hardware

BULK P/N	POLYPACK P/N	DESCRIPTION	QTY
AREA LIGHT			
QH16CTS	QH16CTSP	Post mount area light	50
QH36CTS	QH36CTSP	Multi-directional post mount area light with stainless steel hardware	50
RETAIL			
A700	12V 55W H3 quartz halogen bulb, clam		12
MATERIALS	Plastic housing, glass lens		
VOLT/AMP	12.8VDC - 4.5A		
WT/DIMS	0.663 lb. / 5.875" x 3" x 2.75"		
WARRANTY	Three Year Warranty		



QH16CTS



QH36CTS

HALOGEN LIGHTS

TL10 SERIES 5" Work Lights, Rubber Housings

- Utility/work/ag light with shock proof rubber housing
- #4411 sealed beam
- Include both lead and ground wires
- Steel bracket, 5/16" mounting post

BULK P/N	POLYPACK P/N	DESCRIPTION	QTY
WORK/UTILITY/AG LIGHTS			
TL10CB	TL10CBP	12V, 2-wire	25
TL11CPG	-	12V, self grounding, .180 male bullet	25
RETAIL			
TL10CS	12V Work/utility/ag light, clam		6
TL106CS	6V Work/utility/ag light, clam		6
TL10SS	12V Work/utility/ag light, stainless steel bracket, clam		6
TL12CS	12V Work/utility/ag light, recessed bulb, clam		6

MATERIALS	Rubber housing, glass lens, steel bracket
VOLT/AMP	12.8VDC - 2.8A
WT/DIMS	1.235 lbs. / 4.75" x 4.75" x 2.5"
WARRANTY	Three Year Warranty



TL10CB





TL35/46 SERIES 55W Rectangular Utility/Ag Lights

- Utility/ag light with heavy duty plastic housing
- 12V 55W H3 halogen bulb
- Include both lead and ground wires
- Adjustable, steel mounting bracket



TL35FS/TS



TL46FS/TS

BULK P/N	POLYPACK P/N	DESCRIPTION	QTY
UTILITY/AG LIGHTS			
TL35TB	-	3" x 5" lens, trapezoid beam	20
RETAIL			
TL35FS	3" x 5" lens, flood beam, box		3
TL35TS	3" x 5" lens, trapezoid beam, box		3
TL46FS	4" x 6" lens, flood beam, clam		3
TL46TS	4" x 6" lens, trapezoid beam, clam		3
A700	12V 55W H3 quartz halogen bulb, clam		12

MATERIALS	Plastic housing, glass lens, steel bracket
VOLT/AMP	12.8VDC - 4.5A
WT/DIMS	TL35: 1.5 lbs. / 6.5" x 4.375" x 3.75" TL46: 1.5 lbs. / 5.375" x 4.5" x 2.25"
WARRANTY	Three Year Warranty

HALOGEN LIGHTS



RB10A Magnet Mount Rotary Beacon

- 12V rotary beacons for magnet mount
- 10-ft coil cord with power plug
- Replaceable bulb



RB10A

BULK P/N	DESCRIPTION	QTY
RETAIL		
RB10A	Yellow rotary beacon, clam	6

MATERIALS	Acrylic lens
VOLT/AMP	12.8VDC - 1.45A
WT/DIMS	1.6 lb. / 4.75" x 4.75" x 5.25"
WARRANTY	Three Year Warranty

DL16 SERIES 55W Docking Lights

- Docking light with heavy duty plastic housing, glass lens
- 12V 55W H3 halogen bulb
- Includes both lead and ground wires with male bullets
- Stainless steel mounting bracket with rubber cover
- Kits include two lights, wiring, mounting hardware and switch



DL16CC



DL16WC

BULK P/N	POLYPACK P/N	DESCRIPTION	QTY
RETAIL			
DL16CC	Kit, black housing, clam		3
DL16WC	Kit, white housing, clam		3
A700	12V 55W H3 quartz halogen bulb, clam		12

MATERIALS	Plastic housing, glass lens, stainless steel bracket
VOLT/AMP	12.8VDC - 4.5A
WT/DIMS	0.663 lb. / 5.875" x 3" x 2.75"
WARRANTY	Three Year Warranty

HALOGEN LIGHTS

DL55 SERIES 55W Marine Flood Lights

- Flood light with heavy duty plastic housing, glass lens
- 12V 55W H3 halogen bulb
- Includes both lead and ground wires
- Stainless steel mounting bracket



DL55CS

BULK P/N	POLYPACK P/N	DESCRIPTION	QTY
RETAIL			
DL55CS	55W marine flood light, clam		6
A700	12V 55W H3 quartz halogen bulb, clam		12

MATERIALS	Plastic housing, glass lens, stainless steel bracket
VOLT/AMP	12.8VDC - 4.5A
WT/DIMS	1.333 lb. / 6.25" x 4.25" x 3"
WARRANTY	Three Year Warranty



RVSTL10/11 SERIES LED RV Combination Tail Lights

- Combination stop/turn/tail light for surface mount
- Low profile, round design
- Driver side light includes LED license plate illuminator and mounting bracket
- Hard wired, ground wire included



RVSTL10



RVSTL11

BULK P/N	POLYPACK P/N	DESCRIPTION	QTY
RED STOP/TURN/TAIL LIGHT - 6 DIODES			
RVSTL10	RVSTL10P	Passenger side	25
RVSTL11	RVSTL11P	Driver side, 2-LED license light	25
RETAIL			
RVSTL10K		Set: RVSTL10, RVSTL11, mounting hardware, clam	2

FMVSS	S2 T2 I6 A L
MATERIALS	Acrylic lens and plastic housing
VOLT/AMP	12.8VDC - Stop/Turn .117/Tail .053
WT/DIMS	RVSTL10: .44 lbs / 5.9" x 5.61" x 1.33" RVSTL11: .475 lbs / 8" x 7" x 1.33"
WARRANTY	Lifetime LED Warranty

RV COMBINATION
TAIL LIGHTS

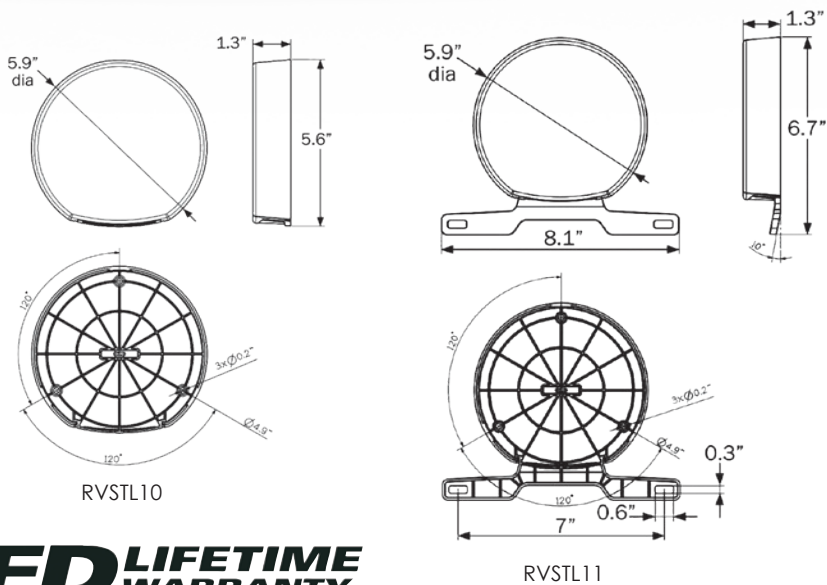

LED LIFETIME WARRANTY
NO BULBS TO REPLACE, EVER!

RVSTL20/21 SERIES LED RV Combination Tail Lights



- Combination stop/turn/tail light for surface mount
- Low profile, oblong arched design
- Driver side lights include LED license plate illuminator and mounting bracket
- Hard wired, ground wire included



RVSTL20



RVSTL21

BULK P/N	POLYPACK P/N	DESCRIPTION	QTY
RED STOP/TURN/TAIL LIGHT - 6 DIODES			
RVSTL20	RVSTL20P	Passenger side	25
RVSTL21	RVSTL21P	Driver side, with 2-LED license light	25
RETAIL			
RVSTL20K		Set: RVSTL20, RVSTL21, mounting hardware, clam	2

FMVSS	S2 T2 I6 A L
MATERIALS	Acrylic lens and plastic housing
VOLT/AMP	12.8VDC - 0.117A Stop/Turn, .053A Tail
WT/DIMS	RVSTL20: .418 lbs / 7.50" x 3.77" x 1.29" RVSTL21: .468 lbs / 7.5" x 5.02" x 1.29"
WARRANTY	Lifetime LED Warranty

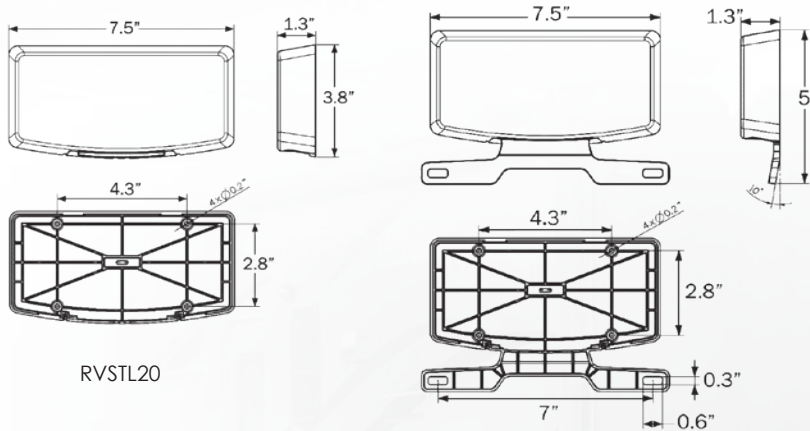

RVSTL20

RVSTL21

LED LIFETIME WARRANTY
NO BULBS TO REPLACE, EVER!

RV COMBINATION
TAIL LIGHTS



RVSTL60/61 SERIES

LED Low Profile RV Combination Tail Lights

- 9-LED combination stop/turn/tail light for surface mount
- Driver side lights include 3-LED license plate illuminator and mounting bracket
- Snap-on, replaceable lens
- Available with white or black base
- Hard wired, ground wire included

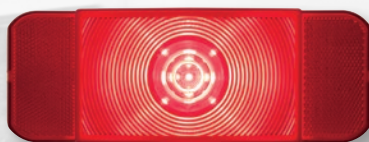

RVSTL60
RVSTLB60



RVSTL61

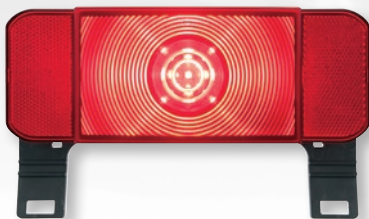

RVSTLB61

RV COMBINATION
TAIL LIGHTS

BULK P/N	POLYPACK P/N	DESCRIPTION	QTY
LED RV COMBINATION TAIL LIGHTS - 9 DIODES			

RVSTL60	RVSTL60P	Passenger side, white base	48
RVSTL61	RVSTL61P	Driver side, white base, 3-LED license light	48
RVSTLB60	RVSTLB60P	Passenger side, black base	48
RVSTLB61	RVSTLB61P	Driver side, black base, 3-LED license light	48

ACCESSORIES

RV60BK	RV60BKP	Wedge base, white	100
RV60BBK	RV60BBKP	Wedge base, black	100
AST60B	AST60BP	Replacement lens, passenger side	10
AST61B	AST61BP	Replacement lens, driver side	10

RETAIL

RVSTL60S	Passenger side, white base, clam	6
RVSTL61S	Driver side, white base, clam	6
RVSTLB60FS	Passenger side, black base, clam	6
RVSTLB61FS	Driver side, black base, clam	6



LED LIFETIME WARRANTY
NO BULBS TO REPLACE, EVER!

FMVSS	A S2 T2 I6
MATERIALS	Acrylic lens and plastic housing
VOLT/AMP	12.8VDC - .243A Stop/Turn, .046A Tail
WT/DIMS	RVSTL60: .419 lb. / 8.625" x 3.188" x 2.25" RVSTL61: .419 lb. / 8.625" x 5" x 2.25"
WARRANTY	Lifetime LED Warranty

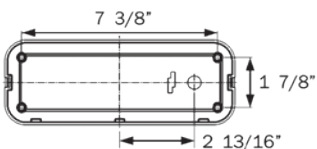
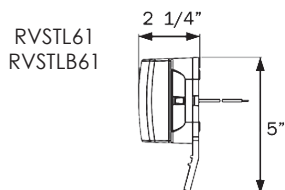
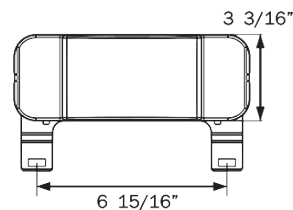
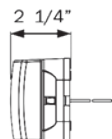
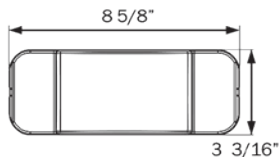
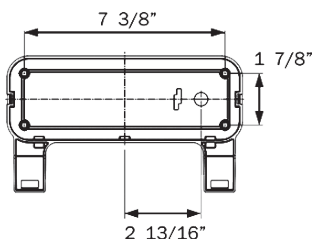

RVSTL60
RVSTLB60

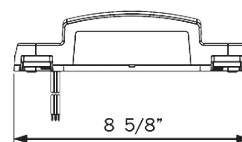

RVSTL0060/61 SERIES

ONE™ LED Series RV Combination Tail Lights



- ONE™ LED Combination stop/turn/tail light with built-in reflex
- Driver side lights include LED license plate illuminator and mounting bracket
- Surface mount design with snap-on lens
- Available with white or black base
- Hard wired, ground wire included

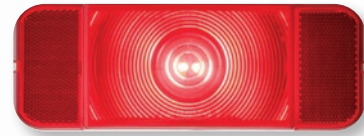

RVSTL0060

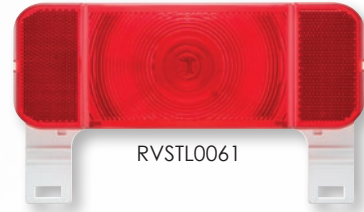

RVSTL0061



RVSTLB0060



RVSTLB0061

BULK P/N	POLYPACK P/N	DESCRIPTION	QTY
ONE™ LED RV COMBINATION TAIL LIGHTS			
RVSTL0060	RVSTL0060P	Passenger side, white base	48
RVSTL0061	RVSTL0061P	Driver side, white base	48
RVSTLB0060	RVSTLB0060P	Passenger side, black base	48
RVSTLB0061	RVSTLB0061P	Driver side, black base	48
ACCESSORIES			
RV60BK	RV60BKP	Wedge base, white	100
RV60BBK	RV66BBKP	Wedge base, black	100
RETAIL			
RVSTL0060RFK	Set: pair of tail lights, white base, clam	Retail Ready	2

FMVSS	A S2 T2 I6
MATERIALS	Acrylic lens and plastic housing
VOLT/AMP	RVSTL0060: 12.8VDC .34A Stop/Turn, .01A Tail RVSTL0061: 12.8VDC .43A Stop/Turn, .094A Tail
WT/DIMS	RVSTL0060 .456 lbs. / 8.688" x 3.188" x 2.25" RVSTL0061 .513 lbs. / 8.688" x 5" x 2.25"
WARRANTY	Lifetime LED Warranty

LED LIFETIME WARRANTY
NO BULBS TO REPLACE, EVER!

RV COMBINATION TAIL LIGHTS

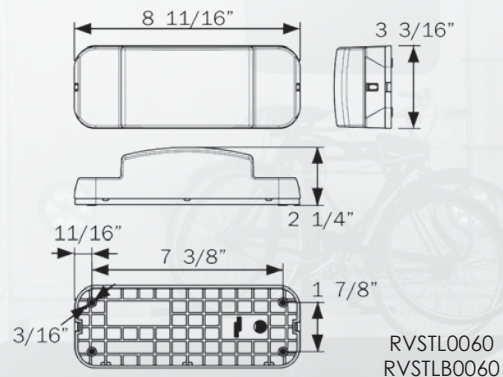
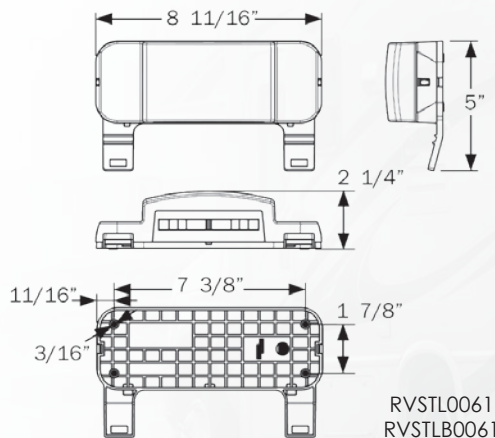



RVST60/61 SERIES

Low Profile RV Combination Tail Lights



RVST60
RVSTB60



RVST61



RVSTB61



RV60BK

- Combination stop/turn/tail light for surface mount
- Driver side lights include license plate illuminator and mounting bracket
- Snap-on lens and replaceable bulb
- Available with white or black base
- Hard wired, ground wire included

BULK P/N	POLYPACK P/N	DESCRIPTION	QTY
RV COMBINATION TAIL LIGHTS			
RVST60	RVST60P	Passenger side RV tail light, white base	48
RVST61	RVST61P	Driver side RV tail light, white base	48
RVSTB60	RVSTB60P	Passenger side RV tail light, black base	48
RVSTB61	RVSTB61P	Driver side RV tail light, black base	48
ACCESSORIES			
RV60BK	RV60BKP	Wedge base, white	100
RV60BBK	RV66BBKP	Wedge base, black	100
AST60B	AST60BP	Replacement lens, passenger side	10
AST61B	AST61BP	Replacement lens, driver side	10
A1157B	A1157BP	1157 replacement bulb	50
RETAIL			
RVST60S	Passenger side, white base, clam		6
RVST61S	Driver side, white base, clam		6

FMVSS	A S2 T2 I6
MATERIALS	Acrylic lens and plastic housing
VOLT/AMP	12.8VDC - 2.65A Stop, 2.10A Tail
WT/DIMS	RVST60: .419 lb. / 8.625" x 3.188" x 2.25" RVST61: .419 lb. / 8.625" x 5" x 2.25"
WARRANTY	Three Year Warranty

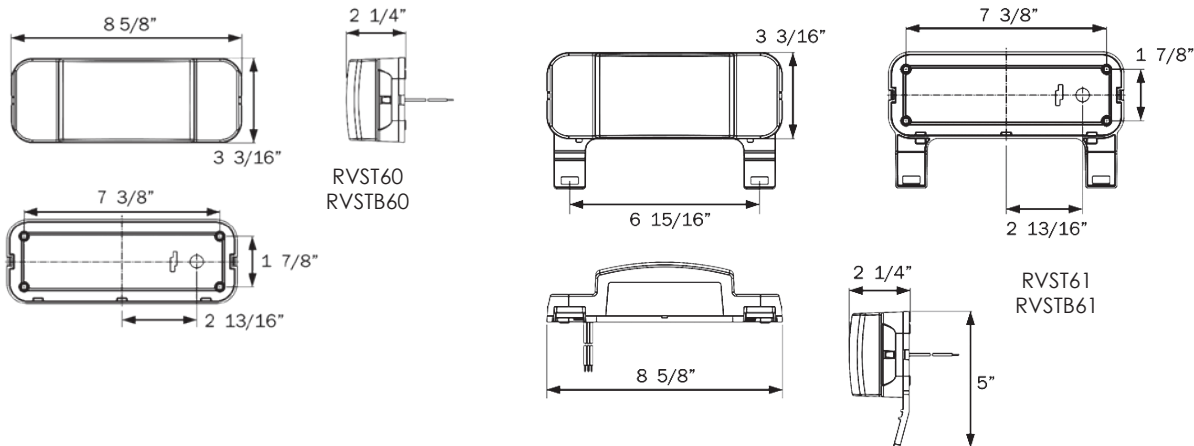

RV COMBINATION
TAIL LIGHTS

RVCST90 SERIES Streamline Sealed LED Lights



- Sonically sealed, waterproof
- Assemblies include two clear lens red stop/turn/tail lights and one clear lens yellow turn signal
- Hard wired with separate ground wire
- Durable corrosion proof housing with chrome finish

BULK P/N	POLYPACK P/N	DESCRIPTION	QTY
TAIL LIGHT ASSEMBLIES			
RVCST90BL		Left side, black housing; two clear lens red stop/tail lights, one clear lens yellow turn signal	2
RVCST90BR		Right side, black housing; two clear lens red stop/tail lights, one clear lens yellow turn signal	2

FMVSS	S T I
MATERIALS	Polycarbonate lens, plastic housing
VOLT/AMP	12.8V - Stop 1.15A/Tail 0.08A
WT/DIMS	2.0 lbs. / 12.875" x 21.875" x 1.75"
WARRANTY	Lifetime LED Warranty

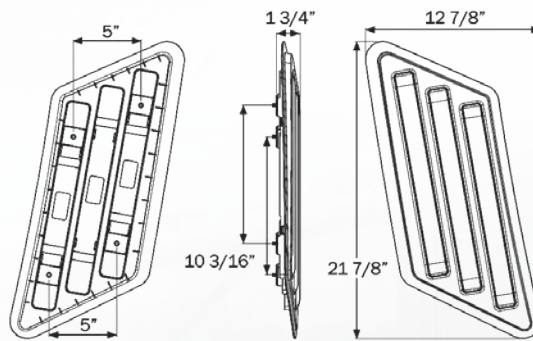

RVCST90BL



RVCST90BR

RV COMBINATION
TAIL LIGHTS

LED LIFETIME WARRANTY
NO BULBS TO REPLACE, EVER!



RVPLL11AB



RVPLL13CB

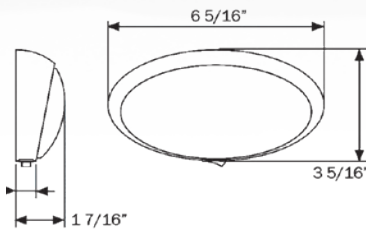
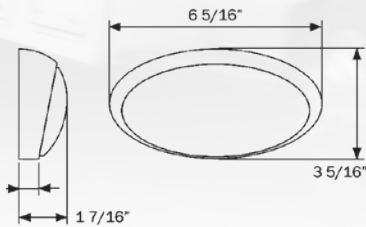

RVPLL11/13 SERIES LED Oval Porch/Utility Lights

- LED surface mount porch utility lights available with or without switch
- Black housing with snap-on lens and 16 SMD LEDs
- Available with yellow or clear lens
- Hard wired with separate ground wire

BULK P/N	POLYPACK P/N	DESCRIPTION	QTY
YELLOW PORCH LIGHTS - 16 DIODES			
RVPLL11AB	RVPLL11ABP	Black housing	50
RVPLL13AB	RVPLL13ABP	Black housing, switch	50
CLEAR UTILITY LIGHTS - 16 DIODES			
RVPLL11CB	RVPLL11CBP	Black housing	50
RVPLL13CB	RVPLL13CBP	Black housing, switch	50
RVPLL13CWB	RVPLL13CWBP	White housing, switch	50
RETAIL			
RVPLL11AFS	Yellow light, black housing, clam		12
RVPLL11CFB	Clear light, black housing, clam		12

CERTIFICATION

MATERIALS	Acrylic lens and plastic housing
VOLT/AMP	12.8VDC - Amber .295A, White .32A
WT/DIMS	0.5 lb / 6.375" x 3.312" x 1.437"
WARRANTY	Lifetime LED Warranty

LED LIFETIME WARRANTY
NO BULBS TO REPLACE, EVER!

RVPL1/3 SERIES

Rectangular Porch/Utility Lights

- Surface mount porch/cabin lights (CSA/UL listed)
- White housing with snap-on lens and replaceable bulb (1141)
- Available with yellow or clear lens
- Hard wired with separate ground wire

BULK P/N	POLYPACK P/N	DESCRIPTION	QTY
YELLOW PORCH LIGHTS			
RVPL1A	RVPL1AP	Yellow porch light, no switch	50
RVPL3A	RVPL3AP	Yellow porch light with switch	50
CLEAR UTILITY LIGHTS			
RVPL1C	RVPL1CP	Clear utility light, no switch	50
RVPL3C	RVPL3CP	Clear utility light with switch	50
ACCESSORIES			
APL1AB	APL1ABP	Yellow replacement lens	10
APL1CB	APL1CBP	Clear replacement lens	10
RETAIL			
RVPL3CFS	Clear utility light, clam		12

CERTIFICATION	CSA / UL
MATERIALS	Acrylic lens and plastic housing
VOLT/AMP	12.8VDC - 1.4A
WT/DIMS	.419 lb. / 6.375" x 3.5" x 2.094"
WARRANTY	Three Year Warranty

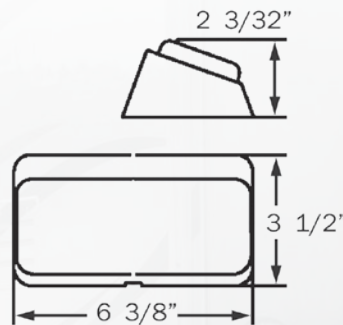

RVPL1A



RVPL3A



RVPL1C



RVPL3C

RV PORCH/CABIN & SECURITY LIGHTS



RVPL5/7 SERIES Oval Porch/Utility Lights

- Surface mount porch utility lights available with or without switch
- White or black housing with snap-on lens and replaceable bulb (1141)
- Available with yellow or clear lens
- Hard wired with separate ground wire



RVPL5A



RVPL5AB



RVPL7A



RVPL7AB



RVPL5CB



RVPL7C



RVPL7CB

BULK P/N	POLYPACK P/N	DESCRIPTION	QTY
YELLOW PORCH LIGHTS			
RVPL5A	RVPL5AP	Yellow porch light, white housing, no switch	50
RVPL5AB	RVPL5ABP	Yellow porch light, black housing, no switch	50
RVPL7A	RVPL7AP	Yellow porch light, white housing, with switch	50
RVPL7AB	RVPL7ABP	Yellow porch light, black housing, with switch	50
CLEAR UTILITY LIGHTS			
RVPL5CB	RVPL5CBP	Clear utility light, black housing, no switch	50
RVPL7C	RVPL7CP	Clear utility light, white housing, with switch	50
RVPL7CB	RVPL7CBP	Clear utility light, black housing, with switch	50
ACCESSORIES			
APL5AB	APL5ABP	Yellow replacement lens	10
APL5CB	APL5CBP	Clear replacement lens	10
RETAIL			
RVPL5AFS	Yellow porch light, white housing, clam		12
RVPL7CFS	Clear utility light, white housing, clam		12
RVPL7CBFS	Clear utility light, black housing, clam		12

CERTIFICATION	CSA / UL
MATERIALS	Acrylic lens and plastic housing
VOLT/AMP	12.8VDC - 1.4A
WT/DIMS	.265 lb. / 6.25" x 3.438" x 1.875"
WARRANTY	Three Year Warranty

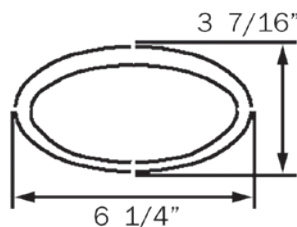
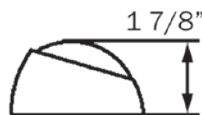

RVSL21/31 SERIES

Scare Lights

- Surface mount security lights with mounting gasket (CSA)
- Stainless steel or white housing with screw-on lens and replaceable bulb (1156)
- Hard wired with separate ground wire

BULK P/N	POLYPACK P/N	DESCRIPTION	QTY
CLEAR SECURITY LIGHTS			
RVSL21	RVSL21P	Scare light, stainless housing	25
RVSL31	RVSL31P	Scare light, white housing	25

CERTIFICATION	CSA
MATERIALS	Acrylic lens, metal housing
VOLT/AMP	12.8VDC - 1.4A
WT/DIMS	0.97 lb. / 8.656" x 8.656" x 1.969"
WARRANTY	Three Year Warranty



RVSL21



RVSL31

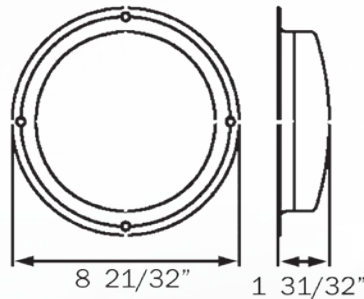

RV PORCH/CABIN
& SECURITY LIGHTS



RVILL39 LED Surface Mount Interior Ceiling Light

- Surface mount ceiling light with switch
- Effective lumen output 230 lm
- Replaceable white snap-on bezel
- Dual power: use with 12VDC and 24VDC systems
- 18-gauge, 6-inch lead and ground wire



RVILL39

BULK P/N	POLYPACK P/N	DESCRIPTION	QTY
INTERIOR CEILING LIGHTS - 9 DIODES			
RVILL39	RVILL39P	Interior light with switch	10

Raw lumen output: 280 lm
Effective lumen output: 230 lm

MATERIALS	Clear PMMA lens, ABS bezel
VOLT/AMP	12.8VDC - 0.25A
WT/DIMS	.325 lb. / 7.188" x 5.188" x 1.438"
WARRANTY	Lifetime LED Warranty

RV INTERIOR LIGHTS

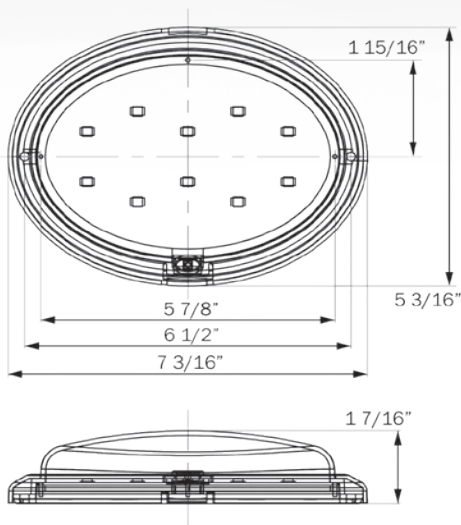

LED LIFETIME WARRANTY
NO BULBS TO REPLACE, EVER!

RVILL40 SERIES LED Surface Mount Interior Light



- Surface mount ceiling light with on/off switch
- Low profile design - only 1" thick
- Color temperature 4500K - bright white illumination
- Hard wired with separate ground wire
- Available in bulk, polypack and retail packaging



RVILL40

BULK P/N	POLYPACK P/N	DESCRIPTION	QTY
INTERIOR CEILING LIGHTS - 9 DIODES			
RVILL40	RVILL40P	Interior light, on/off switch, 2-wire	10
RETAIL			
RVILL40FS	Interior light, on/off switch, 2-wire, clam		12

Raw lumen output: 290 lm
Effective lumen output: 140 lm

MATERIALS	Plastic
VOLT/AMP	12.8VDC - 0.3A
WT/DIMS	.02 lb. / 6.3" x 4" x 1"
WARRANTY	Lifetime LED Warranty

LED LIFETIME WARRANTY
NO BULBS TO REPLACE, EVER!

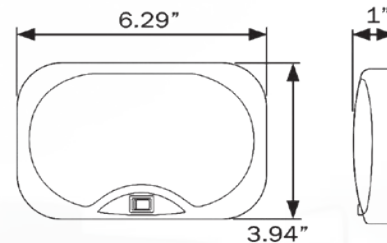

RV INTERIOR LIGHTS



RVILL33/34 SERIES LED Interior RV Lights

- Surface mount interior lights with switch (CSA)
- Single or double lights with snap-on lens
- LED technology – uses 90% less energy
- Hard wired with separate ground wire



RVILL33



RVILL34

BULK P/N	POLYPACK P/N	DESCRIPTION	QTY
LED INTERIOR LIGHTS			
RVILL33	RVILL33P	Single, on/off switch, 9 diodes	50
RVILL34	RVILL34P	Double, on/off switch, 18 diodes	25
RVILL33PB	RVILL33PBP	Single, on/off switch, .180 male bullet on power, ring terminal on ground	50
RETAIL			
RVILL33FS	Single, on/off switch, 9 diodes, clam		6
RVILL34FS	Double, on/off switch, 18 diodes, clam		6

RVILL33 lumen output (raw/effective): 460 lm / 407 lm
RVILL34 lumen output (raw/effective): 920 lm / 815 lm

CERTIFICATION	CSA		
MATERIALS	Polycarbonate lens and plastic housing		
VOLT/AMP	RVILL33:	12.8VDC - 0.3A	
	RVILL34:	12.8VDC - 0.6A	
WT/DIMS	RVILL33:	.794 lb. / 6.377" x 4.173" x 1.787"	
	RVILL34:	1.587 lb. / 10.283" x 4.173" x 1.787"	
WARRANTY	Lifetime LED Warranty		

RV INTERIOR LIGHTS

LED LIFETIME WARRANTY
 NO BULBS TO REPLACE, EVER!

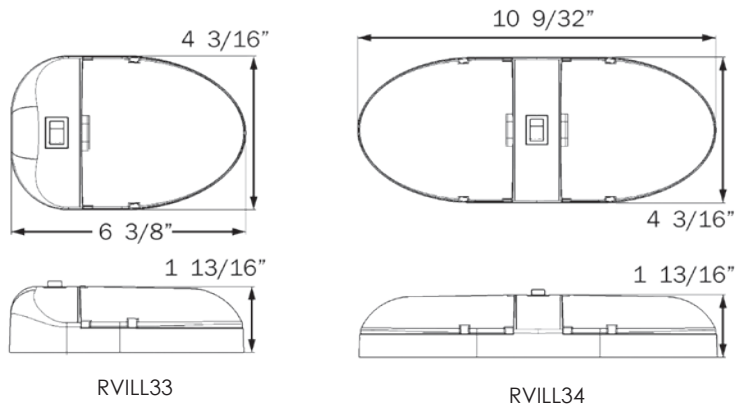

RVIL35

Interior RV Light

- Surface mount interior light with switch (CSA)
- Snap-on lens and replaceable bulb
- Hard wired with separate ground wire

BULK P/N	POLYPACK P/N	DESCRIPTION	QTY
INTERIOR RV LIGHTS			
RVIL35	RVIL35P	Single, on/off switch	50
ACCESSORIES			
ARVIL35B	ARVIL35BP	Replacement lens	10
A921B	-	921 replacement bulb	50

CERTIFICATION	CSA
MATERIALS	Polycarbonate lens and plastic housing
VOLT/AMP	12.8VDC - 1.3A
WT/DIMS	.794 lb. / 6.375" x 4.125" x 1.75"
WARRANTY	Three Year Warranty



RVIL35

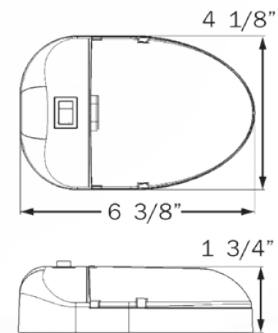

RVIL35

RV INTERIOR LIGHTS



RVIL21/22 SERIES RV Interior Lights

- Surface mount ceiling lights with switch (CSA)
- Single or double lights with snap-on lens and replaceable bulb
- Hard wired with separate ground wire



RVIL21



RVIL22

BULK P/N	POLYPACK P/N	DESCRIPTION	QTY
RV INTERIOR LIGHTS			
RVIL21	RVIL21P	Single, on/off switch	50
RVIL22	RVIL22P	Double, on/off switch	25
ACCESSORIES			
AIL21B	AIL21BP	Clear replacement lens	10
A921B	-	921 replacement bulb	50
RETAIL			
RVIL21S	Single, on/off switch, clam		6
RVIL22S	Double, on/off switch, clam		6

CERTIFICATION	CSA / UL
MATERIALS	Acrylic lens and plastic housing
VOLT/AMP	RVIL21: 12.8VDC - 0.5A RVIL22: 12.8VDC - 1.4A
WT/DIMS	RVIL21: .794 lb. / 7.078" x 4.25" x 1.969" RVIL22: 1.587 lb. / 12" x 4.25" x 1.844"
WARRANTY	Three Year Warranty

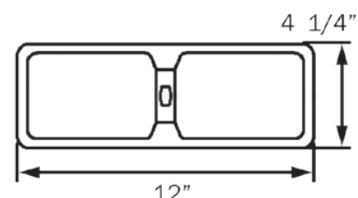
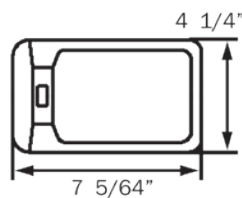
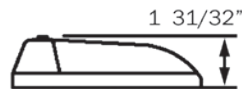

RVIL21

RVIL22

COMPACT COURTESY LIGHTS

- Select LED or Incandescent
- Choose from surface mount and flush mount lights
- Hard wired, include lead and ground

BULK P/N	POLYPACK P/N	DESCRIPTION	QTY
COURTESY LIGHTS			
16802LB	16802LBP	LED black hooded light	50
16802B	16802P	Black hooded light (bulb 194; .24A)	100
19102B	19102P	Flush mount light (bulb 194; .24A)	50

CERTIFICATION	CSA
MATERIALS	Plastic
VOLT	12.8VDC
WT/DIMS	16802B/LB: .2 lb. / 2.75" x 1.75" x 1.5" 19102B: .2 lb. / 4.5" x 1.25"
WARRANTY	Three Year Warranty/ Lifetime LED Warranty



16802B



19102B

CHROME COURTESY LIGHTS

- Hooded lights with chrome finish, white lens
- Hard wired, include lead and ground

BULK P/N	POLYPACK P/N	DESCRIPTION	QTY
COURTESY LIGHTS			
068NME	068NMEP	Snap-in light	50
068WMTE	068WMTEP	Light with stainless steel mounting plate	50

CERTIFICATION	UL
MATERIALS	Metal (068WMTE - stainless steel plate), polycarbonate lens
VOLT/AMP	12.8VDC - 0.59A (bulb 67, 12V 4CP)
WT/DIMS	068NME: .2 lb. / 1.5" x 1.5" x 2" 068WMTE: .2 lb. / 2.75" x 1.625" x 2"
WARRANTY	Three Year Warranty



068NME



068WMTE



WATERPROOF COURTESY LIGHT



24074B

- Submersible design with gaskets
- Hard wired, includes lead and ground

BULK P/N	POLYPACK P/N	DESCRIPTION	QTY
COURTESY LIGHT			
24074B	24074P	Rear mount light with nut	50

CERTIFICATION	CSA
MATERIALS	Plastic
VOLT/AMP	12.8VDC - 1.25A (bulb 194)
WT/DIMS	.2 lb. / 2" x 2" x 1.75"
WARRANTY	Three Year Warranty

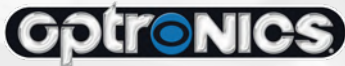

OVAL COURTESY LIGHTS



2407764B

- Semi-recessed with clear lens
- Hard wired, includes lead and ground



2407765B

BULK P/N	POLYPACK P/N	DESCRIPTION	QTY
COURTESY LIGHTS			
04440016B	0440016P	Charcoal finish	100
2407771C	2407771CP	Black finish, chrome reflector	50
04440013B	04440013P	Medium saddle finish	50
2407764B	2407764P	White finish	100
2407765B	2407765P	Dream white finish	50



2407771C

CERTIFICATION	CSA
MATERIALS	Plastic
VOLT/AMP	12.8VDC - .17A (bulb 161, wedge base)
WT/DIMS	.2 lb. / 4" x 2.625" x 1.25"
WARRANTY	Three Year Warranty



04440013B



04440016B

AURORA SERIES

Bullet Light

- Metal directional light with adjustable bracket and switch
- Surface mount with no exposed fasteners
- Hard wired, include lead and ground
- Bulb 922 wedge base incandescent

BULK P/N	POLYPACK P/N	DESCRIPTION	QTY
BULLET LIGHTS			
04010040B	04010040P	Brushed nickel, black switch	30

CERTIFICATION	CSA
MATERIALS	Metal housing
VOLT/AMP	12.8VDC - 0.98A (bulb 922 wedge base)
WT/DIMS	.5 lb. / 2.75" x 3.75" x 4.625"
WARRANTY	Three Year Warranty



04010040B

CO-PILOT LIGHTS

Halogen and Incandescent

- Map lights for sidewalls, drink trays and dashboards
- Switch is incorporated into light design
- Flexible 18" arm

BULK P/N	POLYPACK P/N	DESCRIPTION	QTY
CO-PILOT LIGHTS			
03001175B	03001175P	Halogen (5W bulb/0.35A)	10

CERTIFICATION	UL
MATERIALS	Metal, black finish
VOLT	12.8VDC
WT/DIMS	.6 lb. / 18"
WARRANTY	Three Year Warranty



03001175B

RV DIRECTIONAL LIGHTS



240047171LB & 24004TR71



240147171LB & 24014TR71

LED LIFETIME WARRANTY
NO BULBS TO REPLACE, EVER!

GALAXY LED SERIES

LED Directional Lights

- Recess mount lights with swivel globes and switches
- Removable snap-on trim ring, sold separately
- Hard wired, includes lead and ground

BULK P/N	POLYPACK P/N	DESCRIPTION	QTY
LED DIRECTIONAL LIGHTS			
240047171LB	-	LED Single fixture	50
240147171LB	-	LED Double fixture	20
24004TR71	24004TR71P	Trim ring for single fixture, black	50
24014TR71	24014TR71P	Trim ring for double fixture, black	50
CERTIFICATION	CSA		
MATERIALS	Plastic		
VOLT/AMP	Single: 12.8VDC - 0.020A Double: 12.8VDC - 0.054A		
WT/DIMS	Single: .15 lb. / 3.5" x 4.875" x 1.75" Double: .31 lb. / 3.5" x 9.625" x 1.75"		
WARRANTY	Lifetime LED Warranty		

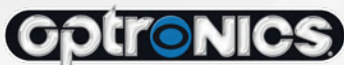

240047171B & 24004TR71



240147171B & 24014TR71

GALAXY SERIES

Directional Lights

- Recess mount lights with swivel globes and switches
- Removable snap-on trim ring, sold separately
- Hard wired, includes lead and ground

BULK P/N	POLYPACK P/N	DESCRIPTION	QTY
DIRECTIONAL LIGHTS			
240047171B	240047171P	Single fixture	50
240147171B	240147171P	Double fixture	20
24004002B	24004002BP	Single fixture with reflector & 5W bulb	50
06001022B	06001022P	Single fixture with reflector	50
24004TR71	24004TR71P	Trim ring for single fixture, black	50
24014TR71	24014TR71P	Trim ring for double fixture, black	50
CERTIFICATION	CSA		
MATERIALS	Plastic		
VOLT/AMP	Single: 12.8VDC - 0.35A (bulb 168 wedge base) Double: 12.8VDC - 0.70A (bulb 168 wedge base)		
WT/DIMS	Single: .24 lb. / 3.5" x 4.875" x 1.75" Double: .47 lb. / 3.5" x 9.625" x 1.75"		
WARRANTY	Three Year Warranty		

UNITEK LED SERIES LED Directional Lights

- Recess mount LED fixtures with multi-locking pivoting globes that activate lights
- Removable snap-on trim ring, sold separately
- Three-terminal hook-up for dome light application

BULK P/N	POLYPACK P/N	DESCRIPTION	QTY
LED DIRECTIONAL LIGHTS			
825LED	825LEDP	Single fixture, 9 diodes, black	50
826LED	826LEDP	Double fixture, 18 diodes, black	50
825TR02	825TR02P	Single trim ring, black	50
826TR02	826TR02P	Double trim ring, black	75
826TR12	826TR12P	Double trim ring, light gray	25
826TR90	826TR90P	Double trim ring, platinum silver	25

CERTIFICATION	UL
MATERIALS	Plastic
VOLT/AMP	12.8VDC - Single 0.35A , Double 0.70A
WT/DIMS	Single: .25 lb. / 4.125" x 3.5" x 1.5" Double: .48 lb. / 7" x 3.875" x 1.375"
WARRANTY	Lifetime LED Warranty



825LED & 825TR02



826LED & 826TR02

LED LIFETIME WARRANTY
NO BULBS TO REPLACE, EVER!

UNITEK SERIES Directional Light

- Recess mount fixture with multi-locking pivoting globes that activate lights
- Removable lenses allow easy bulb replacement
- Removable snap-on trim ring, sold separately
- Three-terminal hook-up for dome light application

BULK P/N	POLYPACK P/N	DESCRIPTION	QTY
DIRECTIONAL LIGHT			
826L	826LP	Double fixture, black	48
See complete listing of trim rings above			

CERTIFICATION	UL
MATERIALS	Plastic
VOLT/AMP	12.8VDC 0.70A (bulb 168 wedge base)
WT/DIMS	.48 lb. / 7" x 3.875" x 1.375"
WARRANTY	Three Year Warranty



826L & 826TR02

RV DIRECTIONAL LIGHTS



ULTRATEK SERIES Directional Lights



06001013B & 3802071BZL



06001014B & 3801071BZL

- Flush mount fixtures with pivoting globes that activate lights
- Removable snap-on trim ring, sold separately
- Removable lens for easy bulb replacement
- Three-terminal hook-up for dome light application

BULK P/N	POLYPACK P/N	DESCRIPTION	QTY
DIRECTIONAL LIGHTS			
06001013B	06001013P	Single fixture, black	120
06001014B	06001014P	Double fixture, black	120
3802071BZL	3802071BZLP	Single trim ring, black	30
3801071BZL	3801071BZLP	Double trim ring, black	30

CERTIFICATION	CSA / NRTL/C / ANSI/UL
MATERIALS	Plastic
VOLT/AMP	Single: 12.8VDC - 0.37A (bulb 590 xenon 4cp) Double: 12.8VDC - 0.74A (bulb 590 xenon 4cp)
WT/DIMS	Single: .27 lb. / 3.75" x 3.5" x 1.5" Double: .40 lb. / 5.875" x 3.5" x 1.5"
WARRANTY	Three Year Warranty



AUTOTEK SERIES Directional Lights



725022B



726022B

- Low profile aircraft-style lights with switch
- Removable grids allow easy bulb replacement
- Snap-on trim ring covers mounting screws
- Three-terminal hook-up for dome light application

BULK P/N	POLYPACK P/N	DESCRIPTION	QTY
DIRECTIONAL LIGHTS			
725022B	725022P	Single fixture, black	25
726022B	726022P	Double fixture, black	20

CERTIFICATION	CSA / UL
MATERIALS	Plastic
VOLT/AMP	Single: 12.8VDC - 0.69A (bulb 906 T5 wedge base) Double: 12.8VDC - 1.38A (bulb 906 T5 wedge base)
WT/DIMS	Single: .32 lb. / 4.625" x 3.5" x 2.25" Double: .52 lb. / 7.625" x 3.5" x 2.25"
WARRANTY	Three Year Warranty

EUROPA SERIES

Directional Lights

- Choose from single recess mount and single/double surface mount series with on/off switches
- Prismatic reflector globes for bright directional beams
- Easy bulb replacement (168 wedge base)

BULK P/N	POLYPACK P/N	DESCRIPTION	QTY
RECESS MOUNT			
06001072B	06001072P	Single fixture, black	20
SURFACE MOUNT			
06001026B	06001026P	Single fixture, black	20
06001015B	06001015P	Double fixture, black	20
06001061B	06001061P	Double fixture plus dome light, black	20
CERTIFICATION	UL / CSA		
MATERIALS	Plastic		
VOLT/AMP	Single: 12.8VDC - 0.35A (bulb 168 wedge base) Double: 12.8VDC - 0.70A (bulb 168 wedge base)		
WT/DIMS	06001072B/P: .18 lb. / 4.5" x 3.75" x 1.75" 06001026B/P: .16 lb. / 4.125" x 2.937" x 1.625" 06001015B/P: .28 lb. / 2.75" x 6.25" x 1.75" 06001061B/P: .46 lb. / 8.375" x 2.75" x 1.75"		
WARRANTY	Three Year Warranty		



06001072B



06001026B
06001015B
06001061B

EUROPA SERIES

Ultrabright Directional Lights

- High output for bright, directional reading light
- Easy bulb replacement (1003 bayonet base)
- Separate switches for each bulb

BULK P/N	POLYPACK P/N	DESCRIPTION	QTY
ULTRA BRIGHT SURFACE MOUNT			
06001048B	06001048P	Single fixture, black	20
06001037B	06001037P	Double fixture, black	20
CERTIFICATION	UL		
MATERIALS	Plastic		
VOLT/AMP	Single: 12.8VDC - 0.94A (bulb 1003 bayonet base) Double: 12.8VDC - 0.94A (bulb 1003 bayonet base)		
WT/DIMS	Single: .25 lb. / 4" x 2.875" x 2.5" Double: .47 lb. / 6.125" x 2.75" x 2.625"		
WARRANTY	Three Year Warranty		



06001048B



06001037B

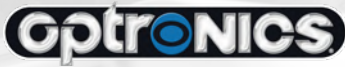

ODYSSEY SERIES Directional Light



0601B & 060102B

- Recess mount light with press on/off feature at lens
- Removable snap-on trim ring, sold separately
- Hard wired, includes lead and ground

BULK P/N	POLYPACK P/N	DESCRIPTION	QTY
DIRECTIONAL LIGHTS			
0601B	0601P	Light, black	200
060102B	060102P	Trim ring, black	50
CERTIFICATION	CSA / NRTL/C / ANSI/UL		
MATERIALS	Plastic		
VOLT	12.8VDC - 0.94A (bulb 906 T5 wedge base)		
WT/DIMS	.26 lb. / 3.125" x 5" x 2"		
WARRANTY	Three Year Warranty		



STARGAZER SERIES Directional Lights



06001001B & 06300004B

- Recess mount fixtures with multi-locking, pivoting globes that activate lights
- Removable snap-on trim ring, sold separately
- Removable lens for easy bulb replacement
- Three-terminal hook-up for dome light application

BULK P/N	POLYPACK P/N	DESCRIPTION	QTY
DIRECTIONAL LIGHTS			
06001001B	06001001P	Single fixture, black	50
06300004B	-	Single trim ring, black	50
CERTIFICATION	CSA / NRTL/C / ANSI/UL		
MATERIALS	Plastic		
VOLT/AMP	12.8VDC - 0.35A (bulb 168 wedge base)		
WT/DIMS	.25 lb. / 3.375" x 4" x 1.5"		
WARRANTY	Three Year Warranty		

CENTURA SERIES

- Simple design with aluminum base, acrylic lens and single or dual switch
- Slim design: only 2.5" wide and 1.13" thick
- Available in 5.5" and 12.5" lengths

BULK P/N	POLYPACK P/N	DESCRIPTION	QTY
SURFACE MOUNT			
105500SP	-	Single bulb, 5.5"	50
105520B	105520BP	Triple bulb, 12.5"	25

MATERIALS	Aluminum base, acrylic lens		
VOLT/AMP	5.5":	12.8VDC - 0.97A (bulb 211)	
	12.5":	12.8VDC - 2.91A (bulb 211-2)	
WT/DIMS	5.5":	.20 lb. / 5.75" x 2.5" x 1.25"	
	12.5":	.44 lb. / 12.75" x 2.5" x 1.25"	
WARRANTY	Three Year Warranty		



105500SP



105520B

SLIMLINE SERIES

- Contemporary design with switch
- Low profile: 4" wide and only 1.5" thick
- Available in two lengths

BULK P/N	POLYPACK P/N	DESCRIPTION	QTY
SURFACE MOUNT			
18543910B	-	Single bulb, 4", no switch, white	25
18543916B	18543916BP	Single bulb, 5.5", switch, white	100

MATERIALS	Plastic		
VOLT/AMP	12.8VDC - 1.0A (bulb 912)		
WT/DIMS	4":	.4 lb. / 4" x 4" x 1.5"	
	5.5":	.6 lb. / 5.5" x 4" x 1.5"	
WARRANTY	Three Year Warranty		



18543910B



18543916B



24113160B DOME LIGHT



24113160B

- Halogen dome light with switch for general illumination
- Designed for overhead or bulkhead surface mount
- White plastic construction with frosted lens

BULK P/N	POLYPACK P/N	DESCRIPTION	QTY
DOME LIGHT			
24113160B	24113160P	5.75" white dome light	30

CERTIFICATION	NRTL/C
MATERIALS	Plastic
VOLT/AMP	12.8VDC - 0.78A (bulb G4 bi-pin)
WT/DIMS	.4 lb. / 5.75" x 5.75" x 1.5"
WARRANTY	Three Year Warranty



357B DOME LIGHT



357B

- 8.5" semi-recess mount light with one halogen and one incandescent bulb
- Chrome plated housing, Lexan lens, replaceable bulbs

BULK P/N	POLYPACK P/N	DESCRIPTION	QTY
DOME LIGHT			
357B	357P	Dome light, chrome-plated	40

MATERIALS	Metal housing, Lexan lens
VOLT/AMP	12.8VDC - 2.79A (GH9 37.5W), 0.68A (906 T5 wedge)
WT/DIMS	1.25 lbs. / 8.75" x 8.75" x 1.875"
WARRANTY	Three Year Warranty

69000201B DOME LIGHT

- 6-3/8" surface mount light with gray base
- Two-wire, replaceable 1142 bulb

BULK P/N	POLYPACK P/N	DESCRIPTION	QTY
DOMELIGHT			
69000201B	69000201P	Dome light, gray base	40
VOLT/AMP	12.8VDC - 1.44A (bulb 1142)		
WT/DIMS	.75 lb. / 6.25" x 6.25" x 2"		
WARRANTY	Three Year Warranty		



69000201B

69000300B DOME LIGHT

- 5-3/4" surface mount light with red and white bulbs
- Dual switch, frosted lens, white housing

BULK P/N	POLYPACK P/N	DESCRIPTION	QTY
DOMELIGHT			
69000300B	69000300P	Dome light, red/white bulbs	20
VOLT/AMP	12.8VDC - 1.00A (bulb 912)		
WT/DIMS	.48 lb. / 5.75" x 5.75" x 1.5"		
WARRANTY	Three Year Warranty		



69000300B

193 SERIES DOME LIGHTS

- Semi-recessed design with domed clear lens
- Replaceable bulb (1003 bayonet)

BULK P/N	POLYPACK P/N	DESCRIPTION	QTY
DOMELIGHT			
193BSP	193BSPP	Dome light, black	10
193G	193P	Dome light, gray	10

MATERIALS	Steel housing, polycarbonate lens		
VOLT/AMP	12.8VDC - 0.94A (bulb 1003 bayonet)		
WT/DIMS	.25 lb. / 5.75" x 2.688" x 1.5"		
WARRANTY	Three Year Warranty		



193BSP



193G



RV MOUNTING ACCESSORIES



RV60BK



RV60BBK

- Wedge base mounting bezels for RV combination tail lights
- Constructed of heavy duty, corrosion proof plastic for durability

BULK P/N	POLYPACK P/N	DESCRIPTION	QTY
----------	--------------	-------------	-----

MOUNTING BASES

RV60BK	RV60BKP	Wedge base mounting bezel, white RVST60/61, RVSTL60/61, RVSTL0060/0061	100
RV60BBK	RV60BBKP	Wedge base mounting bezel, black RVSTB60/61, RVSTLB60/61, RVSTLB0060/0061	100

MATERIALS	Plastic
WT/DIMS	8.563" x 3.125" x 1.125"
WARRANTY	Three Year Warranty



WALL PLATES



BULK P/N	POLYPACK P/N	DESCRIPTION	QTY
----------	--------------	-------------	-----

WALL PLATES / ACCESSORIES

13000018B	13000018P	Standard 12V outlet, plastic	20
014BCRCW	014BCRCWP	Chrome 12V receptacle with cap	100
7850NFRC	7850NFRCP	Chrome 12V receptacle with cap & wires	250
RC	RCP	Rubber cap for 12V outlet	500

DOOR PULLS & SPRING LOADED HANDLES

- 11" door pulls with hinged end caps for easy installation
- Include steel reinforced mounting bases
- Spring loaded handle, may also be used as a clothes hanger; choose from three colors

BULK P/N	POLYPACK P/N	DESCRIPTION	QTY
DOOR PULLS			
01180071B	01180071P	Black	25
01180089B	01180089P	Fawn	25
01180090B	01180090BP	Platinum silver	25
SPRING LOADED HANDLES			
2500128B	2500128P	GM pewter	50
2500171B	2500171P	Black	50
2500189B	2500189P	Fawn	50

MATERIALS	Pulls: ABS, Handles: Steel base, ABS handle
WT/DIMS	Pulls: .31 lb. / 8.75" x 1.125" x 3" Handles: .18 lb. / 11" x 1.75" x 1"
WARRANTY	Three Year Warranty



01180071B
01180089B
01180090B



2500128B

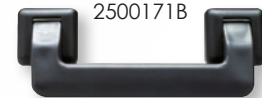

2500171B



2500189B

RV ACCESSORIES



ASH TRAYS



BULK P/N	POLYPACK P/N	DESCRIPTION	QTY
ASH TRAYS			
510001B	510001P	Drop-in ashtray	50
530002B	530002P	Round drop-in ashtray	40
500302B	500302P	Black lighter	25



BEVERAGE HOLDERS



09017101B

- Versatile beverage holder for cups, cans and mugs
- Two-tier design includes a handle recess for cups and mugs, and rubber flaps to secure cans and smaller cups
- Black finish on all



3202B

302B

1502B

BULK P/N	POLYPACK P/N	DESCRIPTION	QTY
CUP HOLDERS			
09017101B	09017101P	Dual purpose drop-in, handle cavity	50
3202B	3202P	3" two-tier drop-in	50
302B	302P	3" single tier drop-in	50
1502B	1502P	1.5" single tier drop-in	50
15202B	15202P	1.5" two-tier drop-in	50
2409171B	2409171BP	Adjustable, fold-down	100

REPLACEMENT BULBS RV LIGHTING

BULK P/N	POLYPACK P/N	DESCRIPTION	QTY
BULBS			
30000000B	-	12" fluorescent, cool white	1
30031010B	-	18" fluorescent, cool white, Philips	24
30655010B	-	10W halogen	1

RECTANGULAR REFLECTORS

- Select from multiple shapes, sizes and mounting methods; available in bulk, polypack and retail clams
- Acrylic construction; meet FMVSS "A" for reflex when properly applied

BULK P/N	POLYPACK P/N	DESCRIPTION	QTY
REFLECTORS			
RE10AB	RE10ABP	Rectangular, yellow, self adhesive	100
RE10RB	RE10RBP	Rectangular, red, self adhesive	100
RE11AB	RE11ABP	Oblong, yellow, self adhesive/screw mount	100
RE11RB	RE11RBP	Oblong, red, self adhesive/screw mount	100
RE15AB	RE15ABP	Thinline, yellow, adhesive/screw mount	100
RE15RB	RE15RBP	Thinline, red, adhesive/screw mount	100
RE52AB	RE52ABP	Rectangular, yellow, self adhesive	50
RE52RB	RE52RBP	Rectangular, red, self adhesive	50
RETAIL - CLAM			
RE10AK		Rectangular, yellow, self adhesive	12
RE10RK		Rectangular, red, self adhesive	12
RE10ARFK		(2) each yellow and red RE10, adhesive	12
RE12AK		Oblong, yellow, self adhesive/screw mount	12
RE12RK		Oblong, red, self adhesive/screw mount	12
RE12ARK		(2) each yellow and red RE12	12
RE15AK		Thinline, yellow, adhesive/screw mount	12
RE15RK		Thinline, red, adhesive/screw mount	12
RE15ARK		Thinline, red & yellow, adhesive/screw mount	12
RE52ARK		(2) each yellow and red RE52	12

FMVSS	A
MATERIALS	Acrylic
WARRANTY	Three Year Warranty

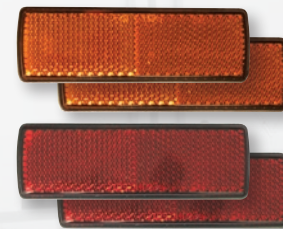
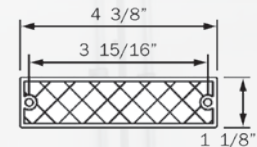
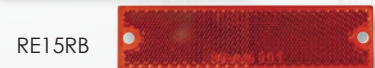
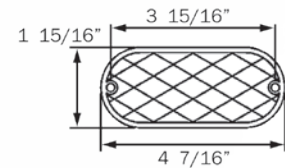
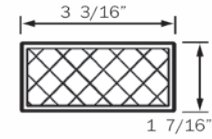
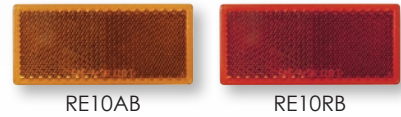

RE52ARK
4" W X 1.25" H X 0.75" D

ROUND & OVAL REFLECTORS

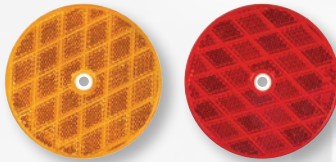

RE13AB

RE13RB

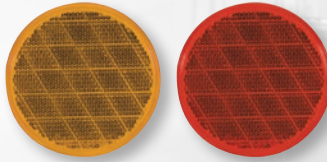
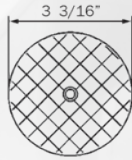

RE21AB

RE21RB

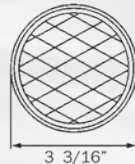

RE31AS

RE31RS

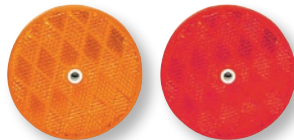
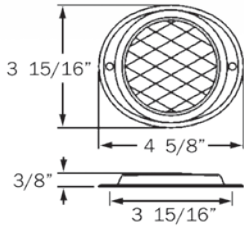

RE35AB

RE35RB

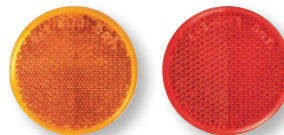
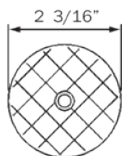

RE37AB

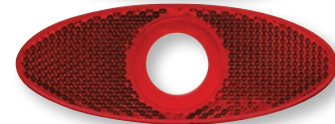
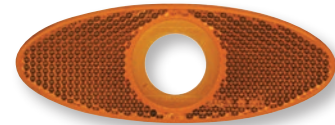
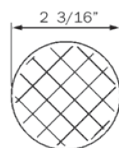

RE37RB

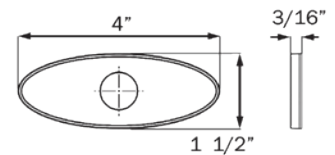

A11AXB / A11RXB



- Select from multiple shapes, sizes and mounting methods; available in bulk, polypack and retail clams
- Acrylic construction; meet FMVSS "A" for reflex when properly applied

BULK P/N	POLYPACK P/N	DESCRIPTION	QTY
REFLECTORS			
A11AXB	A11AXBP	Yellow reflector for 3/4" lights, self adhesive	100
A11RXB	A11RXBP	Red reflector for 3/4" lights, self adhesive	100
RE13AB	RE13ABP	3" round, yellow, center mount	50
RE13RB	RE13RBP	3" round, red, center mount	50
RE21AB	RE21ABP	3" round, yellow, self adhesive	50
RE21RB	RE21RBP	3" round, red, self adhesive	50
RE35AB	RE35ABP	2" round, yellow, center mount	100
RE35RB	RE35RBP	2" round, red, center mount	100
RE37AB	RE37ABP	2" round, yellow, self adhesive	100
RE37RB	RE37RBP	2" round, red, self adhesive	100
RETAIL - CLAM			
RE21AS		3" round, yellow, self adhesive	12
RE21RS		3" round, red, self adhesive	12
RE21ARK		3" round, red & yellow, self adhesive	12
RE31AS		3" armored aluminum, yellow, screw mount	12
RE31RS		3" armored aluminum, red, screw mount	12

FMVSS	A
MATERIALS	Acrylic
WARRANTY	Three Year Warranty

RT10 SERIES Rectangular Adhesive Tape Reflectors

- Oralite® V32 SAE reflectors are SAE J578 and J594 compliant
- Designed for rugged outdoor use on the sides and rear of trucks, trailers and equipment
- Meet FMVSS "A" for reflex when properly applied
- Reflector dimensions 3.5" x 2", supplied in rolls
- Select 100 or 500 reflectors per roll

BULK P/N	POLYPACK P/N	DESCRIPTION	QTY
SELF-ADHESIVE REFLECTORS			
RT10AB	-	Yellow 3.5"x2", roll of 100	100
RT10A1B	-	Yellow 3.5"x2", roll of 500	500
RT10RB	-	Red 3.5"x2", roll of 100	100
RT10R1B	-	Red 3.5"x2", roll of 500	500

FMVSS	A
MATERIAL	Polyester
WT/DIMS	.58 lbs / 167' x 2.50"
WARRANTY	Seven Year Warranty

ORALITE®

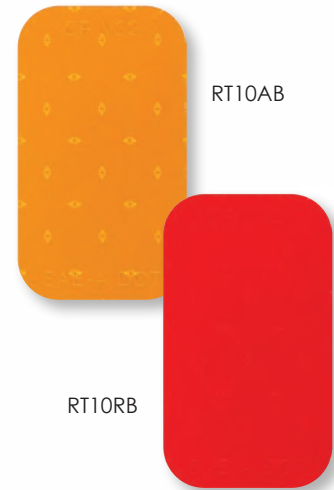

RT21 SERIES Round Adhesive Tape Reflectors

- Oralite® V32 SAE reflectors are SAE J578 and J594 compliant
- Designed for rugged outdoor use on the sides and rear of trucks, trailers and equipment
- Meet FMVSS "A" for reflex when properly applied
- 3" diameter, supplied in 26-ft x 4-in rolls
- 100 reflectors per roll

BULK P/N	POLYPACK P/N	DESCRIPTION	QTY
SELF-ADHESIVE REFLECTORS - 7 YEAR			
RT21AB	-	Yellow 3" round	100
RT21RB	-	Red 3" round	100

FMVSS	A
MATERIAL	Polyester
WT/DIMS	.55 lbs / 26' x 4"
WARRANTY	Seven Year Warranty

ORALITE®

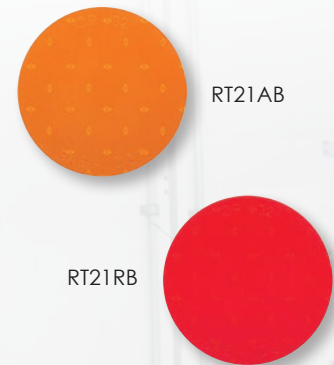

ORALITE[®]

VEHICLE CONSPICUITY TAPE

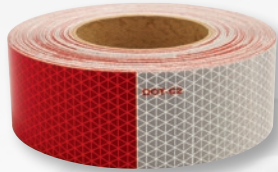

RTR150711B



RT150WBD



RE418T



RTR10150711CB



RTR10150WB



RTR03150711CB

- Alternating red/white pattern available in 11" red/7" white and 6" red/6" white patterns
- Solid white tape also available
- All tape is 2" wide, supplied in 150-ft rolls
- Choose from V92, V82 and V42 series tape
- Marked "DOT-C2" per NHTSA 9CFR571.108

BULK P/N	POLYPACK P/N	DESCRIPTION	QTY
----------	--------------	-------------	-----

V92 CONSPICUITY TAPE - 5 YEAR

RTR15066B	RTR15066BP	6" red/6" white, continuous	1
RTR15066PB	RTR15066PBP	6" red/6" white, perforated	1
RTR150711B	RTR150711BP	11" red/7" white, continuous	1
RTR150711PB	RTR150711PBP	11" red/7" white, perforated	1
RE10018T	-	100 18" strips, 11" red/7" white	1
RT150W12B	RT150W12BP	Solid white, 12" sections on roll	1
RT150WBD	RT150WBDP	Solid white, continuous	1

RETAIL

RE418T		4-strip kit, 11" red/7" white	12
RE18T		8-strip kit, 11" red/7" white	12
RE2018T		20-strip kit, 11" red/7" white	5
RE21T		21-ft roll, 11" red/7" white	12

BULK P/N	POLYPACK P/N	DESCRIPTION	QTY
----------	--------------	-------------	-----

V82 CONSPICUITY TAPE - 10 YEAR

RTR1015066CB	-	6" red/6" white, continuous	1
RTR10150711CB	-	11" red/7" white, continuous	1
RTR10150WB	-	Solid white, continuous	1

BULK P/N	POLYPACK P/N	DESCRIPTION	QTY
----------	--------------	-------------	-----

V42 CONSPICUITY TAPE - 3 YEAR

RTR03150711CB	-	11" red/7" white, continuous	1
RTR0315066CB	-	6" red/6" white, continuous	1

FMVSS	DOT-C2		
WARRANTY	V92:	Five Year Warranty	
	V82:	Ten Year Warranty	
	V42:	Three Year Warranty	

CONSPICUITY TAPE

SCHOOL BUS CONSPICUITY TAPE **ORALITE®**

- Yellow tape available in 1" and 2" widths
- All tape is supplied in 150-ft rolls
- Choose from V99 and V82 series tape
- Meets ASTM D4956-05 (Type V), FMVSS 131 & 217, CSA D250 requirements

BULK P/N	POLYPACK P/N	DESCRIPTION	QTY
V99 CONSPICUITY TAPE - 5 YEAR			
RT150Y1DB	RT150Y1DBP	1" yellow, diamond pattern	1
RT150Y2DB	RT150Y2DBP	2" yellow, diamond pattern	1

BULK P/N	POLYPACK P/N	DESCRIPTION	QTY
V82 CONSPICUITY TAPE - 10 YEAR			
RT150Y1B	RT150Y1BP	1" yellow	1
RT150Y2B	RT150Y2BP	2" yellow	1

FMVSS	ASTM D4956-05 (Type V), FMVSS 131 & 217, CSA D250		
WARRANTY	V99:	Five Year Warranty	
	V82:	Ten Year Warranty	



RT150Y2DB

RT150Y1DB



RT150Y2B

RT150Y1B

VEHICLE CONSPICUITY TAPE

- Conformable sheeting for emergency vehicles
- Supplied in 6" wide, 150-ft rolls
- Choose from fluorescent lime, red and orange (other colors available upon request)
- Use red/lime sheeting to meet fire apparatus regulation NFPA 1901

BULK P/N	POLYPACK P/N	DESCRIPTION	QTY
V98 CONFORMABLE SHEETING			
RTRE150RB	RTRE150RBP	6" red, diamond pattern	1
RTRE150GB	RTRE150GBP	6" lime, diamond pattern	1
RTRE150OB	RTRE150OBP	6" orange, diamond pattern	1

FMVSS	NFPA 1901		
WARRANTY	Red/Orange:	Five Year Warranty	
	Lime:	Three Year Warranty	

ORALITE®

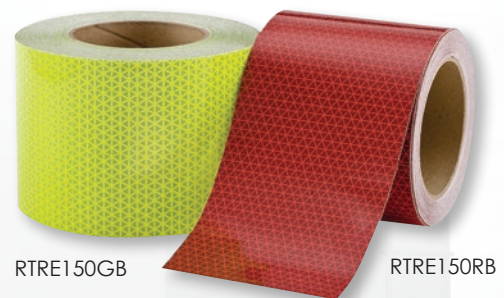

RTRE150GB

RTRE150RB

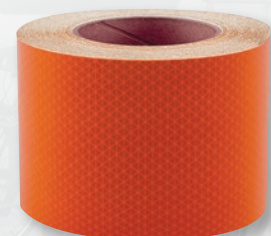

RTRE150OB

CONSPICUITY TAPE

HARNES PROTECTORS

Trailer Harness Plug Protectors

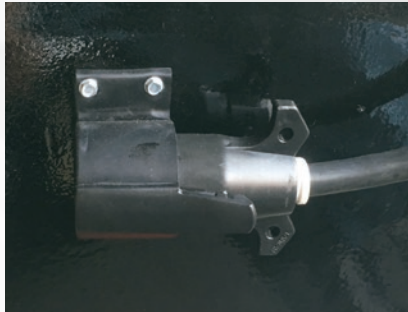

- Secure and protect trailer harness plugs from damage, corrosion and debris
- Helps maintain electrical system reliability
- Easy, surface mount installation
- Corrosion proof design

BULK P/N	POLYPACK P/N	DESCRIPTION	QTY
PLUG PROTECTORS			
ACP5B	ACP5BP	5-way flat harness plug protector	50
ACP7B	ACP7BP	7-way round harness plug protector	64
RETAIL			
ACP5S		4-way & 5-way flat plug protector, clam	10
ACP7S		7-way round plug protector, clam	5

MATERIAL	PVC
WT/DIMS	ACP5B: .025 lbs 1.48" x 1.24" x .45" ACP7B .162 lbs 3.17" x 2.93" x 2.2"
WARRANTY	Three Year Warranty

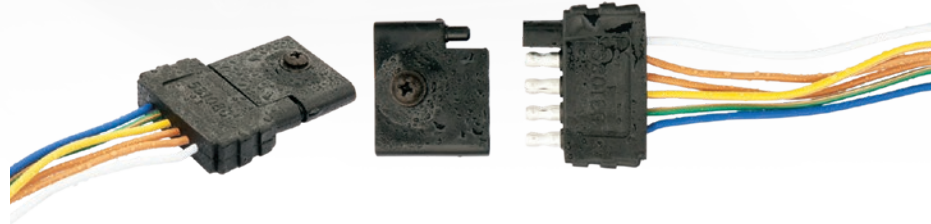

3/4" GROMMETS & BRACKETS

Grommets and Brackets for 3/4" Round Sealed Lights

- PVC grommets for flush mount of 3/4" round lights
- Snap-in mounting flange for secure installation
- Stainless steel trim ring covers grommet
- License plate light brackets for use with LPL12CB

BULK P/N	POLYPACK P/N	DESCRIPTION	QTY
GROMMETS & BRACKETS			
A10BB	A10BBP	Surface mount base, black	100
A10GB	A10GBP	Sealing grommet	100
A11GB	A11GBP	Standard grommet	100
A11G1B	A11G1BP	Grommet, EPDM, 45-55 durometer	100
A11GSDB	A11GSDBP	Grommet, softer durometer	100
A11DB	A11DBP	Adaptor cover 2" and 2.5" holes, accepts 3/4" lights	50
A12GB	A12GBP	Sealing grommet, for material thickness .070-.125"	100
A14GB	A14GBP	Sealing grommet, for material thickness .1250-.250"	100
A11PB	A11PBP	Snap-in mounting flange	100
REFLECTORS/TRIM RINGS			
A11AXB	A11AXBP	Yellow reflector, self adhesive	100
A11RXB	A11RXBP	Red reflector, self adhesive	100
A11SSB	A11SSBP	Stainless steel trim ring	120
A11CRB	A11CRBP	Chrome finish cover	120
LICENSE PLATE LIGHT BRACKETS/ACCESSORIES			
A11GLPB	A11GLPBP	License light bracket, gray	50
A11BLPB	A11BLPBP	License light bracket, black	50
A12B2LPB	A12B2LPBP	Vertical license light bracket	50
A12GLPB	A12GLPBP	Grommet for A12B2LPB bracket	50

P/N	MATERIALS	WT/DIMS
A10BB	ABS	.05 lb. / 3.25" x 1.063" x .938"
A10GB	PVC	.01 lb. / 1.313" x 1.313" x .875"
A11GB	PVC	.05 lb. / 1.083" x 1.083" x .456"
A11G1B	EPDM	.05 lb. / 1.083" x 1.083" x .456"
A11GSDB	PVC	.05 lb. / 1.083" x 1.083" x .456"
A11DB	ABS	.038 lb. / 3.563" x 3.563" x .375"
A12GB	PVC	.05 lb. / 1.094" x 1.094" x .465"
A14GB	PVC	.05 lb. / 1.094" x 1.094" x .465"
A11PB	Polycarbonate	.05 lb. / 1.156" x 1.156" x 0.75"
A11SSB	Stainless steel	.05 lb. / 1.313" x 1.313" x 0.125"
A11CRB	Chrome	.01 lb. / 1.1" x 1.1" x 0.1"
A11GLPB/BLPB	Polycarbonate	.08 lb. / 2.25" x 1.375" x 0.625"
A12GLPB	PVC	.12 lb. / 3.438" x 2.688" x 2.313"
A11AXB/RXB	Acrylic	.05 lb. / 4" x 1.5" x .188"



A10BB



A10GB



A11GB
A12GB
A14GB



A11DB



A11PB



A11SSB

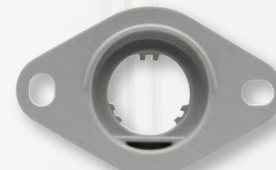

A11GLPB



A12B2LPB bracket shown with light and A12GLPB grommet

2" GROMMETS & ACCESSORIES

Grommets, Mounting Brackets and Trim Rings for 2" Round Lights

- PVC grommet for flush mount of 2" round lights provides shock mount to lengthen bulb life
- Choice of two surface mount brackets
- Trim rings for grommet or flange mount lights, screw mount

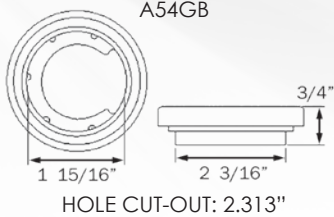

HOLE CUT-OUT: 2.313"

BULK P/N	POLYPACK P/N	DESCRIPTION	QTY
MOUNTING ACCESSORIES			
A53GB	A53GBP	Extra-flex flush mount grommet	100
A54GB	A54GBP	Flush mount grommet	100
A54GK	A54GKP	Kit: A54GB & A46PB PL-10 plug	100
A2CBGB	A2CBGBP	Closed back grommet	50
BK5557GB	BK5557GBP	Cam-on mounting bracket	50
A55CB	A55CBP	Chrome trim ring, grommet mount	20
A3TRSSB	A3TRSSBP	Stainless steel trim ring, flange mount	100
BK53BB	BK53BBP	Branch deflector bracket, gray	50
WIRING ACCESSORIES			
A46PB	A46PBP	Two-pin plug with 6" lead, #10 terminal on ground	50

P/N	MATERIALS	WT/DIMS
A53GB	PVC	.05 lb. / 3" x 3" x 1"
A54GB	PVC	.05 lb. / 2.625" x 2.625" x 0.75"
BK5557GB	ABS	.05 lb. / 4" x 2.125" x 1"
A55CB	ABS	.05 lb. / 3.25" x 3.25" x 0.438"
A3TRSSB	Stainless steel	.05 lb. / 3.063" x 3.063" x 0.125"
BK53BB	ABS	.05 lb. / 5.375" x 2.75"



A55CB



A3TRSSB



BK5557GB

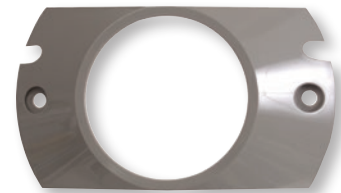

BK53BB

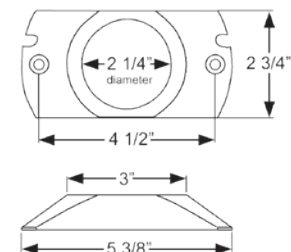
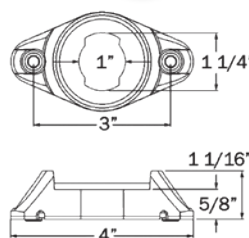
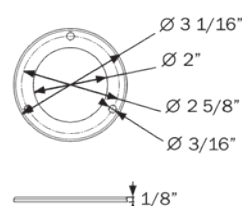
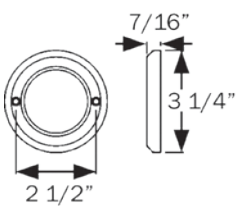

MOUNTING & WIRING ACCESSORIES

2.5" GROMMETS

Mounting Grommets for 2.5" Round Sealed Lights

- PVC grommets for flush mount of 2.5" round lights
- Grommet provides shock mount to lengthen bulb life

BULK P/N	POLYPACK P/N	DESCRIPTION	QTY
MOUNTING ACCESSORIES			
A55GB	A55GBP	Open back, flush mount, black	50
A55GK	A55GKP	Kit: A55GB & A46PB PL-10 plug	100
A56GB	A56GBP	Closed back, recess mount, black	100
A57GB	A57GBP	Open back, recess mount, black	50
A57GK	A57GKP	Kit: A57GB & A46PB PL-10 plug	100
A58GB	A58GBP	Angled grommet, black	100
WIRING ACCESSORIES			
A46PB	A46PBP	PL-10 plug with 6" lead, #10 terminal on ground	100

P/N	MATERIALS	WT/DIMS
A55GB/GWB	PVC	.132 lb. / 3.5" x 3.5" x .938"
A56GB	PVC	.132 lb. / 3.25" x 3.25" x 1.125"
A57GB	PVC	.11 lb. / 3.25" x 3.25" x 1.125"
A58GB	PVC	.132 lb. / 3.438" x 3.438" x 0.875"



A55GB

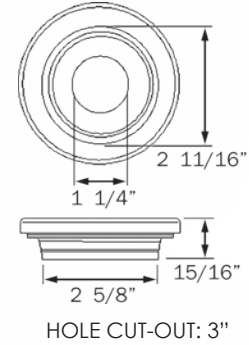

A56GB

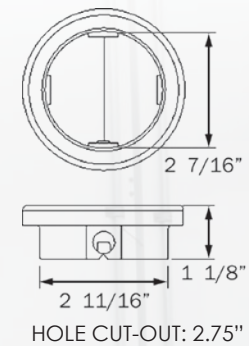

A57GB

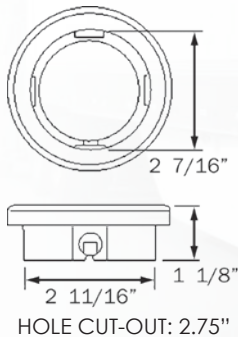

A58GB

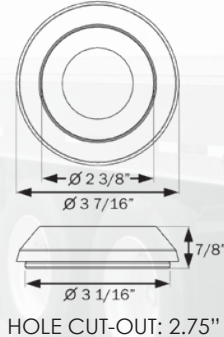

2.5" BRACKETS & TRIM RINGS

Mounting Brackets and Ornamental Trim Rings for 2.5" Round Sealed Lights

- Choice of three brackets for surface mount of 2.5" round sealed lights
- Trim rings for grommet or flange mount lights, screw mount



BK55BB

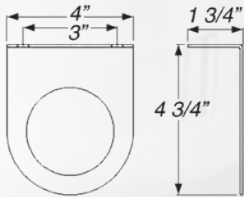

BK57BB

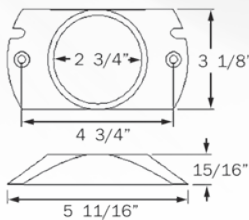

BULK P/N	POLYPACK P/N	DESCRIPTION	QTY
MOUNTING ACCESSORIES			
BK55BB	BK55BBP	Black steel bracket for use with grommet; no cut-out in trailer frame required	20
BK57BB	BK57BBP	Surface mount branch deflector bracket, gray plastic	50
BK5557GB	BK5557GBP	Cam-on mounting bracket with built-in branch deflector, suitable for use with PC rated lights	50
A25TRSSB	A25TRSSBP	Stainless steel trim ring, flange mount	50
A57CB	A57CBP	Chrome trim ring, grommet mount	20

P/N	MATERIALS	WT/DIMS
BK55BB	Steel	.375 lb. / 4" x 4.75" x 1.75"
BK57BB	Polycarbonate	.066 lb. / 5.688" x 3.125" x 0.938"
BK5557GB	Plastic	.066 lb. / 4" x 2.125" x 1"
A25TRSSB	Stainless steel	.04 lb. / 3.5" x 3.5" x 0.125"
A57CB	Plastic	.11 lb. / 4" x 4" x 0.415"



A25TRSSB

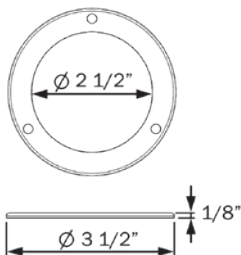

A57CB

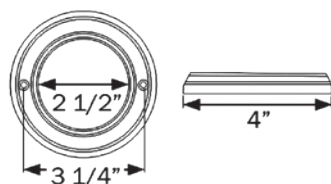

BK5557GB

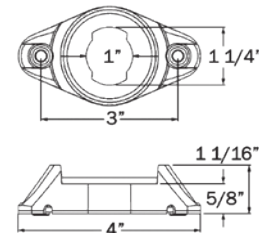

4" ROUND GROMMETS and BRACKETS

Mounting Grommets & Brackets for Sealed 4" Round Lights

- PVC grommets for flush mount of 45 series lights; grommet provides shock mount to lengthen life of light
- Mounting flanges for flush mount of 45 series lights; lights snap into flange
- Steel bracket mounts to trailer frame; no panel cutout required. Use with A45GB grommet. Durable powder coated finish.

BULK P/N	POLYPACK P/N	DESCRIPTION	QTY
GROMMETS			
A45GB	A45GBP	PVC grommet, flush mount	50
A46GB	A46GBP	Extra-flex PVC grommet, flush mount	50
BRACKETS			
A45BB	A45BBP	Black plastic mounting flange	100
A45SB	A45SBP	Stainless steel mounting flange	20
BK45BB	BK45BBP	Steel mounting bracket, powder coated	10

P/N	MATERIALS	WT/DIMS
A45GB	PVC	.176 lb. / 5.375" x 5.375" x 1.063"
A45BB	Plastic	.11 lb. / 5.5" x 5.5" x 1"
A45SB	Stainless steel	.19 lb. / 5.563" x 5.563" x 0.75"
A46GB	PVC	.05 lb. / 5.625" x 5.625" x 1.063"
BK45BB	Steel	.794 lb. / 6" x 5.813" x 1.375"



A45GB

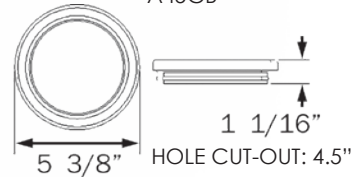

A45SB

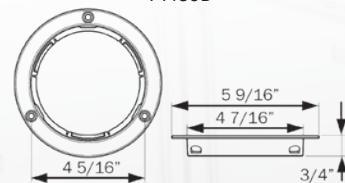

BK45BB

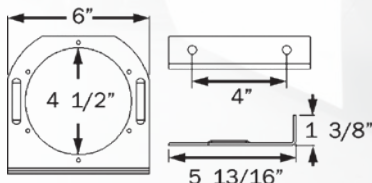

A46GB

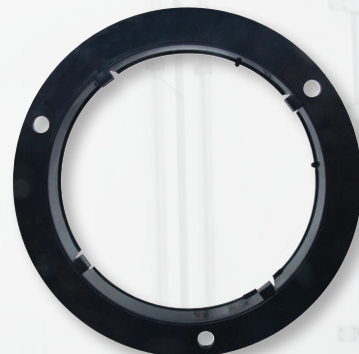
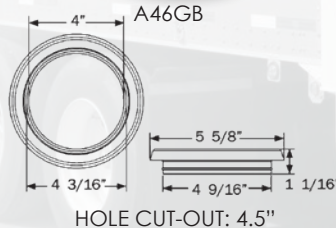

A45BB

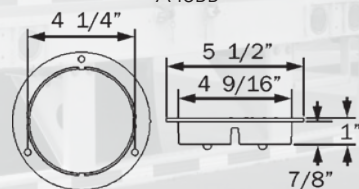

4" ROUND TRIM RINGS

Trim Rings for Sealed 4" Round Lights

- Stainless steel models fit flange mount lights
- Chrome-plated plastic model fits grommet mount lights
- Trim rings mount using screws



A5TRSSB

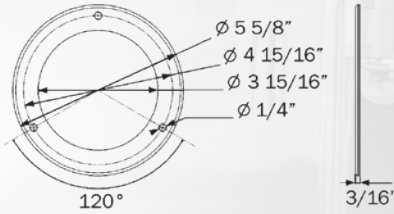

BULK P/N	POLYPACK P/N	DESCRIPTION	QTY
TRIM RINGS			
A5TRSSB	A5TRSSBP	Stainless steel trim ring for flange mount lights	100
A45CGB	A45CGBP	Chrome-plated plastic trim ring for grommet mount lights	20
A101TRSSB	A101TRSSBP	Stainless steel trim ring for STL/BUL101 flange mount lights	50



A45CGB

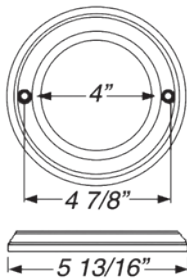

P/N	MATERIALS	WT/DIMS
A5TRSSB	Stainless steel	.132 lb. / 5.625" x 5.625" x 0.188"
A45CGB	Plastic	.132 lb. / 5.813" x 5.813" x 0.5"
A101TRSSB	Stainless steel	.132 lb. / 5.625" x 5.625" x 0.188"



A101TRSSB

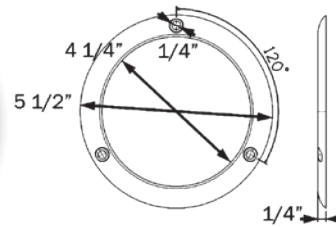

6" OVAL GROMMETS/BRACKETS

Mounting Grommets & Brackets for Sealed 6" Oval Lights

- PVC grommets for flush mount of 70 series lights; grommet provides shock mount to lengthen life of light
- Steel brackets mount to trailer frame; no panel cutout required. Use with A70GB grommet or recess flange mount lights.

BULK P/N	POLYPACK P/N	DESCRIPTION	QTY
GROMMETS			
A60GB	A60GBP	PVC grommet	50
A70GB	A70GBP	PVC grommet, flush mount	50
A70GBD	A70GBDP	PVC grommet	50
A80GB	A80GBP	PVC grommet, flush mount	50
BRACKETS			
A77S1B	A77S1BP	Steel mounting bracket, gray	50
BK70BB	BK70BBP	Steel mounting bracket, powder coated	10
BK70B	BK70BP	Steel mounting bracket, no coating	10

P/N	MATERIALS	WT/DIMS
A60GB	PVC	.132 lb. / 7.625"x3.375"x1.125"
A70GB	PVC	.132 lb. / 7.625" x 3.375" x 1.125"
A80GB	PVC	.132 lb. / 7.625"x3.375"x1.125"
A77S1B	Steel	.132 lb. / 8.25" x 5.75" x 1.375"
BK70BB	Steel	.728 lb. / 8.25" x 4" x 1.625"
BK70B	Steel	1 lb. / 8.25" x 4" x 1.625"



A70GB

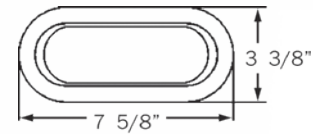

HOLE CUT-OUT: 6.85" x 2.5" (1.25" R)



BK70BB

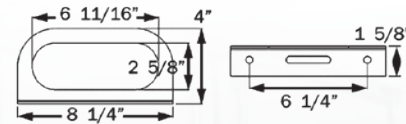

A77S1B

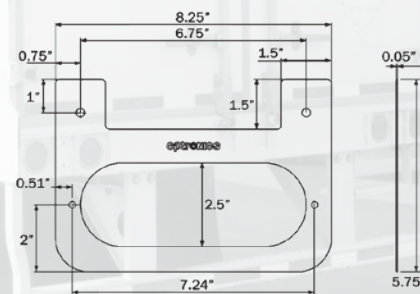

6" OVAL FLANGE COVERS

Trim Rings for 6" Oval Sealed Flange Mount Lights

- Choose from stainless steel, chrome-plated plastic and red reflex models
- A7TRSSB mounts to STL75AMFB flange using screws
- A78CB1 and A78RXB snap onto flange/surface mount lights
- A78RXB fulfills rear reflex function, eliminating the need for a separate reflector

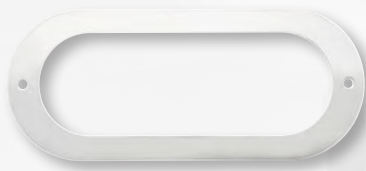

A7TRSSB

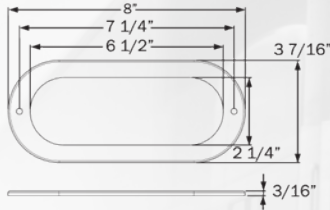

A78CB1

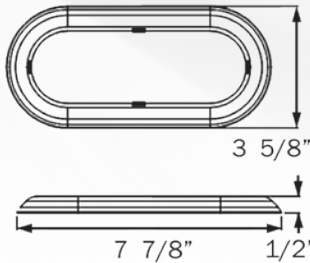

A78RXB

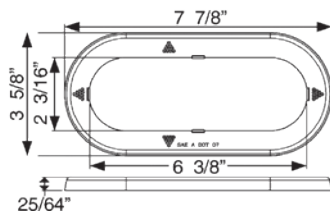

A111TRSSB

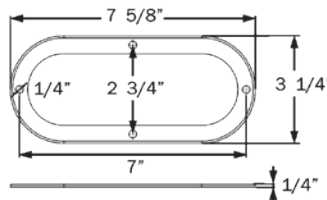

A178TRSSB

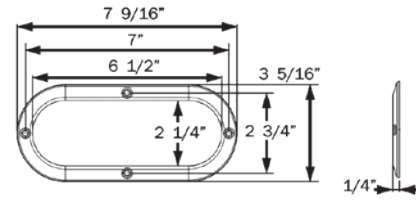

BULK P/N	POLYPACK P/N	DESCRIPTION	QTY
FLANGE COVERS			
A7TRSSB	A7TRSSBP	Stainless steel, screw mount (STL75AMFB)	100
A78CB1	A78CB1P	Chrome-plated plastic, snap-on	25
A78RXB	A78RXBP	Red reflex, snap-on	25
A78NCCB	A7NNBP	Paintable trim ring, snap-on	50
A78NCCBB	A7NCCBBP	Black trim ring, snap-on	50
A111TRSSB	A111TRSSBP	Stainless steel screw mount trim ring for STL/BUL111 flange mount lights	50
A178TRSSB	A178TRSSBP	Stainless steel screw mount trim ring for STL178 flange mount lights	50
A211CB1	A211CB1P	Chrome bezel, snap-on	25
A211NCCB	A211NCCBP	Paintable trim ring, snap-on	50
A211RXB	A211RXBP	Red reflex flange ring	25

P/N	MATERIALS	WT/DIMS
A7TRSSB	Stainless steel	.066 lb. / 8" x 3.438" x 0.188"
A78CB1	ABS Plastic	.066 lb. / 7.875" x 3.625" x 0.5"
A78RXB	Acrylic	.066 lb. / 7.875" x 3.625" x 0.391"
A78NCCB	Plastic	.100 lb. / 7.875" x 3.625" x 0.5"
A78NCCBB	Plastic	.100 lb. / 7.875" x 3.625" x 0.5"
A111TRSSB	Stainless steel	.066 lb. / 7.625" x 3.25" x 0.25"
A178TRSSB	Stainless steel	.066 lb. / 7.563" x 3.313" x 0.188"
A211CB1	Plastic	.066 lb. / 7.5" x 3.25" x .5"
A211NCCB	Plastic	.100 lb. / 7.875" x 3.625" x 0.5"
A211RXB	Plastic	.066 lb. / 7.875" x 3.625" x 0.5"

91 SERIES GROMMETS

Mounting Grommets for A91, AL90, AL191 and AL91 Series Lights

- PVC grommets for flush mount of 90/91 series lights
- A91G15B1 allows light to be mounted at 15 degrees

BULK P/N	POLYPACK P/N	DESCRIPTION	QTY
GROMMETS			
A91GB	A91GBP	Black grommet, flush mount	100
A91GOB	A91GOBP	Black open back grommet	100
A91G15B1	A91G15B1P	Black 15 degree angled grommet	100
A91GZB	-	Black vertical mount grommet	50
WIRING ACCESSORIES			
A46PB	A46PBP	Two-wire plug, standard PL-10 connector	100

P/N	MATERIALS	WT/DIMS
A91GB/GOB	PVC	.066 lb. / 3.313" x 1.938" x 0.5"
A91G15B1	PVC	.066 lb. / 3.313" x 1.938" x 1.313"



A91GB

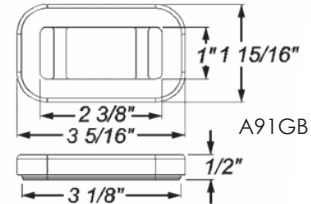

A91GB

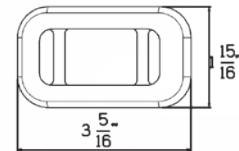
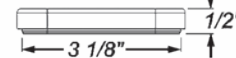

A91G15B1

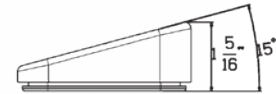

91 SERIES BRACKETS

Mounting Brackets for A91, AL90, AL191 and AL91 Series Lights

- Corrosion proof brackets for surface mount of 90/91 series lights
- Self grounding bases ground through mounting hardware and should be used with A91LW plug
- Open back bases should be used with A46PB two-wire plug

BULK P/N	POLYPACK P/N	DESCRIPTION	QTY
SURFACE MOUNT BRACKETS			
A91BB	A91BBP	Black base, self grounding	100
A91BS	-	A91BB, retail clam	12
A91BOB	A91BOBP	Black base, open back	100
A91CB	A91CBP	Chrome base, self grounding	100
A91OB	A91OBP	Chrome base, open back	100
A90CB	A90CBP	Chrome cover, snap-on	50
WIRING ACCESSORIES			
A91LW	A91LWP	Single wire plug, molded male bullet	100
A46PB	A46PBP	Two-wire plug, standard PL-10 connector	100

P/N	MATERIALS
All Brackets	Plastic



A91CB

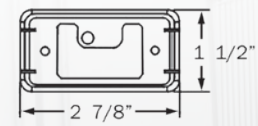

A91BB/CB

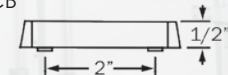

A91BOB

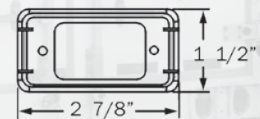

A91BOB/OB

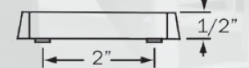

MC65/A67 SERIES BRACKETS

Mounting Brackets for MCL61 & MC/MCL65 Series Lights

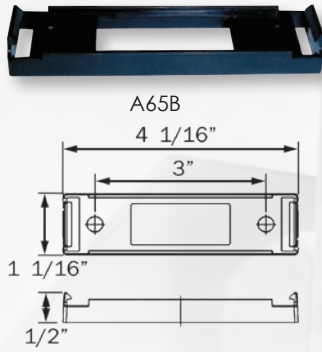

- Corrosion proof brackets for surface mount of 61/65 series lights
- Single wire design grounds through mounting hardware
- Two-wire design includes both lead and ground wires
- A67BB bracket for use in exterior (top) fender applications with MC65ARB, MCL61ARB and MCL65ARB

BULK P/N	POLYPACK P/N	DESCRIPTION	QTY
SURFACE MOUNT BRACKETS			
A65B	A65BP	Black bracket only	50
A65PB	A65PBP	Kit: A65B & A65P single wire plug	50
A65PS	-	A65PB, retail clam	12
A65PBPG	A65PBPGP	Kit: A65B & A65P single wire plug with .180 molded male bullet	50
A65TB	A65TBP	Black bracket only, thick base	50
A66PB	A66PBP	Kit: Gray bracket & A65P single wire plug	50
A67CB	A67CBP	Kit: Chrome bracket & A65P, 12" lead	50
A67CBPG	A67CBPGP	Kit: Chrome bracket & single wire plug with .180 molded male bullet, 18" lead	50
A67P10G	A67P10GP	Kit: Chrome bracket & single wire plug with .180 molded male bullet, 10" lead	100
A68PB	A68PBP	Kit: A65B & A68P two-wire plug	50
A68P1B	A68P1BP	Kit: Tall bracket, black, with A68P two-wire plug	50
A65PRXB	A65PRXBP	Kit: Black bracket with red reflector installed & single wire plug	50
SURFACE MOUNT FENDER BRACKETS			
A67BB	A67BBP	Black fender bracket with self grounding, single wire plug	50
WIRING ACCESSORIES			
A65P	A65PP	One-wire plug, grounds through mounting hardware	50
A68P	A68PP	Two-wire plug, includes lead and ground	50

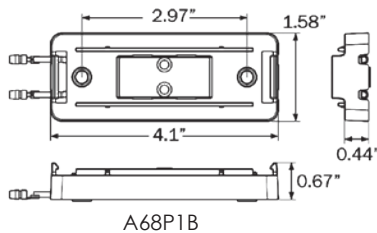

P/N	MATERIALS
All brackets	Plastic

LICENSE LIGHT BRACKETS

LP25SB surface mount bracket accepts LP91 and LPL91 series lights; mounting gasket sold separately

BULK P/N	POLYPACK P/N	DESCRIPTION	QTY
LICENSE LIGHT BRACKETS			
LP25SB	LP25SBP	Black bracket for LP/LPL91 lights	100
LP25SGGB	LP25SGGBP	Grey bracket for LP/LPL91 lights	100
A25GB	A25GBP	Gasket for LP25SB	100

P/N	MATERIALS	WT/DIMS
LP25SB/GGB	Polycarbonate	.066 lb. / 3.438" x 2.688" x 2.313"
A25GB		.010 lb. / 3.438" x 1.9" x 0.70"



LP25SB



LP25SGGB

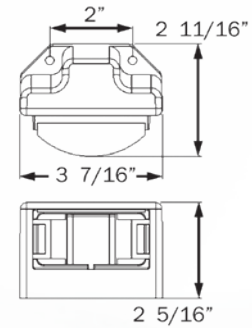

A25GB



MOUNTING & WIRING ACCESSORIES

LICENSE PLATE BRACKETS

- Select from heavy duty metal and corrosion proof plastic
- Accept stud mount license plate lights
- LP35BB license plate holder is design for mounting on flat surfaces



LP5SB

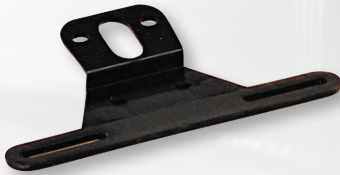
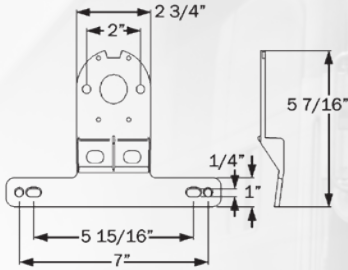

LP10SB

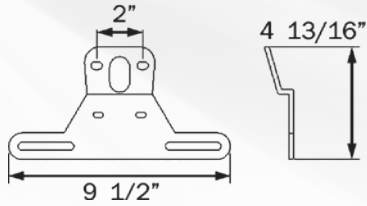

BK31BB
LP31SB

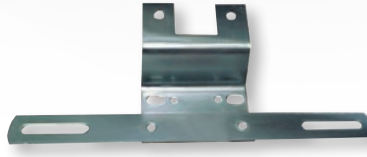
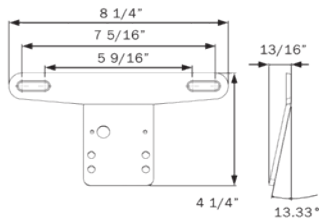

LP15SB

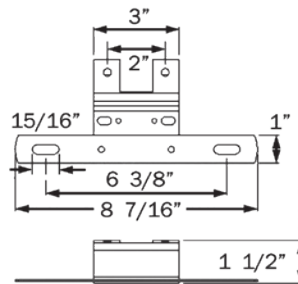

LP20SB

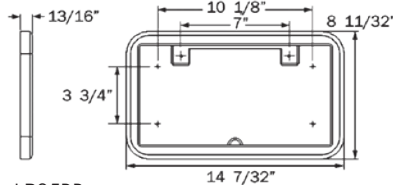
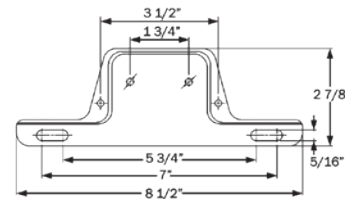

LP35BB

BULK P/N	POLYPACK P/N	DESCRIPTION	QTY
BRACKETS			
LP5SB	LP5SBP	Black heavy duty plastic	100
LP10SB	LP10SBP	Black heavy duty plastic	50
LP15SB	LP15SBP	Zinc plated steel	12
LP20SB	LP20SBP	Powder coated steel	25
LP31SB	LP31SBP	Black heavy duty plastic for low temps	50
LP35BB	LP35BBP	Black license plate holder	25
BK31BB	BK31BBP	Black heavy duty plastic	50
RETAIL			
LP10S		Black heavy duty plastic, clam	12
LP15S		Zinc plated steel, clam	12

P/N	MATERIALS	WT/DIMS
LP5SB	Plastic	.17 lb. / 8.25" x 4.25" x .813"
LP10SB	Plastic	.17 lb. / 9.5" x 4.813"
LP15SB	Steel	.397 lb. / 8.438" x 3.625" x 1.5"
LP20SB	Steel	.132 lb. / 8.5" x 2.875"
LP31SB	Plastic - low temp	.17 lb. / 8.25" x 4.25" x .813"
LP35BB	Plastic	.122 lb. / 14.5" x 8.25"
BK31BB	Plastic	.17 lb. / 8.25" x 4.25" x .813"

MOUNTING ACCESSORIES

Trim Rings and Bezels

BULK P/N	POLYPACK P/N	DESCRIPTION	QTY
TRIM RINGS/BEZELS			
00212317B	00212327P	M1 series chrome bezel (poly case qty: 20)	200
00212217B	00212227P	M3 series chrome bezel (poly case qty: 20)	500
00212117B	00212127P	M4 series chrome bezel (poly case qty: 20)	70
00212717B	00212727P	M5 series chrome bezel (poly case qty: 20)	500
060102B	060102P	Trim ring for Odyssey directional light, black	50
24004TR71	24004TR71P	Trim ring for Galaxy single fixture 240047171B and 240047171LB, black	50
24014TR71	24014TR71P	Trim ring for Galaxy double fixtures 240147171B and 240147171LB	50
825TR02	825TR02P	Single trim ring for Unitek directional lights 825L and 825LED, black	50
826TR02	826TR02P	Double trim ring for Unitek directional lights 826L and 826LED, black	75
826TR12	826TR12P	Double trim ring for Unitek directional lights 826L and 826LED, light grey	25
826TR90	826TR90P	Double trim ring for Unitek directional lights 826L and 826LED, platinum silver	25

P/N	MATERIALS	WT/DIMS
00212317B	Chrome	.047 lb. / 6.625" x 2.188" x .75"
00212217B	Chrome	.010 lb. / 3" x 2" x .7"
00212117B	Chrome	.010 lb. / 9" x 3.25" x .7"
00212717B	Chrome	.010 lb. / 4.188" x 1.5" x .7"
060102B	Chrome	.010 lb. / 5" x 3.125" x 1"
24004TR71	Plastic	.010 lb. / 3.875" x 5.25" x .75"
24014TR71	Plastic	.020 lb. / 4" x 10" x .25"
825TR02	Plastic	.010 lb. / 4.875" x 3.625" x 1"
826TR02/TR12/TR90	Plastic	.20 lb. / 7.25" x 3.875" x 1"



00212317B



00212217B



00212117B



00212717B



060102B



24004TR71



24014TR71



825TR02



826TR02



826TR12



826TR90

MOUNTING ACCESSORIES

Trim Rings and Bezels



3802071BZL



3801071BZL



0630004B



A0028CRB



A15CB/A15CGB



A06TR



A13C2B/A13C210B



A13B2B/A13B210B



A13NCC2B



A09BB



A09WB

BULK P/N	POLYPACK P/N	DESCRIPTION	QTY
BASES/BEZELS			
3802071BZL	3802071BZLP	Single trim ring for Ultratek directional light 06001013B, black	30
3801071BZL	3801071BZLP	Double trim ring for Ultratek directional light 06001014B, black	30
06300004B	06300004P	Single trim ring for Stargazer directional, black	150
A0028CRB	A0028CRBP	Chrome snap-on bezel fits MCL0028 and MCL0030 series	50
A06TR	A06TRP	White trim ring for ILL06/07	50
A09BB	A09BBP	UCL09 trim ring, black	50
A09CB	A09CBP	UCL09 trim ring, chrome	50
A09WB	A09WBP	UCL09 trim ring, white	50
A13B2B	A13B2BP	MCL/UCL13 base/bezel, black	100
A13B210B	A13B210BP	MCL/UCL13 base/bezel, matte black, fits #10 screw	100
A13C2B	A13C2BP	MCL/UCL13 base/bezel, chrome	100
A13C210B	A13C210BP	MCL/UCL13 base/bezel, chrome, fits #10 screw	100
A13NCC2B	A13NCC2BP	MCL/UCL13 base/bezel, unfinished	100
A15CB	A15CBP	MCL15 base/bezel, chrome	100
A15CGB	A15CGBP	MCL15 base/bezel, chrome with gasket	100

P/N	MATERIALS	WT/DIMS
3802071BZL	Plastic	.010 lb. / 3.875" x 3.625" x .1875"
3801071BZL	Plastic	.020 lb. / 6.125" x 3.625" x .1875"
06300004B	Plastic	.10 lb. / 3.625" x 4.375" x 1.25"
A0028CRB	Plastic	.010 lb. / 4" x 2" x .70"
A06TR	ABS	.06 lb. / 11" x 4" x .25"
A09BB/CB/WB	ABS	.06 lb. / 3.421" x 3.421" x .287"
A13B2B/B210B	ABS	.088 lb. / 3.236" x 1.791" x .43"
A13C2B/C210B	Plastic	.088 lb. / 3.236" x 1.791" x .43"
A13NCC2B	Plastic	.088 lb. / 3.25" x 1.791" x .43"
A15CB/CGB	ABS	.088 lb. / 3.938" x 1.374" x .5"

MOUNTING & WIRING ACCESSORIES

MOUNTING ACCESSORIES

Trim Rings, Bases and Bezels

BULK P/N	POLYPACK P/N	DESCRIPTION	QTY
TRIM RINGS/BEZELS			
A17CB	A17CBP	Chrome bezel for MCL17 series marker/clearance light	100
A19CB	A19CBP	Chrome bezel for MCL19 series marker/clearance light	100
A21CHB	A21CHBP	ILL21 bezel, chrome	25
A41CBB	A41CBBP	UCL41B bezel, black	50
A41CRB	A41CRBP	UCL41B bezel, chrome	50
A48CB	A48CBP	MCL48 & MCL73 bezel, chrome	50
A64BB	A64BBP	STL64/264 base/bezel, black	50
A64CRB	A64CRBP	STL64/264 base/bezel, chrome	50
A68SSB	A68SSB	Stainless steel snap-on trim ring for STL68RB	20
A69CB	A69CBP	STL69 & MCL70 base/bezel, chrome	10
A69NCCB	A69NCCBP	STL69 & MCL70 base/bezel, unfinished	50
A69RXC	A69RXCBP	STL69RRXB base/bezel, chrome	10

P/N	MATERIALS	WT/DIMS
A17CB	Plastic	.010 lb. / 4.188" x 1.375" x 0.625"
A19CB	Plastic	.020 lb. / 5.75" x 1.563" x .5"
A21CHB	ABS	.088 lb. / 6.313" x 6.313" x .563"
A41CBB/CRB	Plastic	.10 lb. / 8.7" x 2.95" x 1.59"
A48CB	ABS	.088 lb. / 6" x 2.25" x 1.125"
A64BB/CRB	Chrome	.20 lb. / 21.5" x 1.5" x 0.5"
A68SSB	SS	.088 lb / 10.125" x 3" x .375"
A69CB	ABS	.176 lb. / 16.313" x 1.625" x 0.813"
A69RXC	ABS	.176 lb. / 16.313" x 1.875" x 0.813"



A17CB



A19CB



A21CHB



A48CB



A41CBB



A41CRB



A68SSB



A64BB



A64CRB

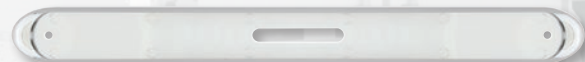

A69CB



A69RXC

MOUNTING ACCESSORIES

Trim Rings, Bases and Bezels



A70ECBB



A70ECCRB

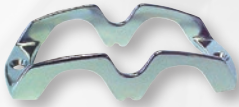

BK42CB



BK66DB



BK66D1B



A94VB

BULK P/N	POLYPACK P/N	DESCRIPTION	QTY
BASES/BEZELS			
A70ECBB	A70ECBBP	Black end cap for ILL70 series	100
A70ECCRB	A70ECCRBP	Chrome end cap for ILL70 series	100
A71CBAWN	A71CBAWNP	Chrome finish plastic base for ILL71CBAWN	10
A71CCBWAN	A71CCBWANP	Chrome finish plastic base/ bezel for ILL71CBAWN	10
A71C1BAWN	A71C1BAWNP	Chrome base for ILL71C1BAWN	25
A79CB	A79CBP	MCL78/88 and STL79/80/89/90 series base/bezel, chrome	10
A94VB	A94VP	Black steel visor for 7" warning lamps	25
BK42CB	BK42CBP	Steel mounting bracket, chrome plated	100
BK66DB	BK66DBP	Heavy duty armored base for MCL66 series lights; die cast metal	50
BK66D1B	BK66D1BP	Heavy duty armored base for MCL66 series lights; die cast metal, black finish	50

P/N	MATERIALS	WT/DIMS
A70ECBB/ECCRB	Plastic	.010 lb.
A71CBAWN	ABS	.176 lb. / 18" x 2" x 1"
A71CCBWAN	Plastic	.020 lb. / 18" x 2.125" x 1.063"
A71C1BAWN	Chrome	.10 lb. / 16.866" x 1.91" x .526"
A79CB	ABS	.176 lb. / 18.875" x 2" x 0.813"
A94VB	Steel	.81 lb. / 7.25" x 7.25" x 4"
BK42CB	Steel	.243 lb. / 5.438" x 2.375" x 1.125"
BK66DB	Metal	.132 lb. / 4.25" x 1.125" x 1.688"
BK66D1B	Metal	.132 lb. / 4.25" x 1.125" x 1.688"



A79CB



A71CCBWAN



A71C1BAWN

MOUNTING ACCESSORIES

Miscellaneous Mounting Grommets, Brackets & Accessories

- A33GB is PVC grommet for flush mount of 33/35 series lights; grommet provides shock mount to lengthen life of light
- A40SRB secures lens of ST series lights

BULK P/N	POLYPACK P/N	DESCRIPTION	QTY
GROMMET - ST/STL33 SERIES			
A33GB	A33GBP	PVC grommet, flush mount	50
LOCKING RING - MCL11 SERIES			
A11SRB	A11SRBP	Stainless steel locking ring for MCL11S series	100
RETENTION RING - ST40 SERIES			
A40SRB	A40SRBP	Snap ring for ST40 series lights	100
BRACKETS - UCL SERIES			
BK20BB	BK20BBP	Bracket kit, UCL series	25

P/N	MATERIALS	WT/DIMS
A33GB	PVC	.353 lb. / 6.25" x 4.125" x 1.625"
A11SRB	Steel	.05 lb. / 1.5" diameter x 0.125"
A40SRB	Metal	.066 lb. / 5.125" diameter x 0.125"
BK20BB	Aluminum	.75 lb.



A33GB

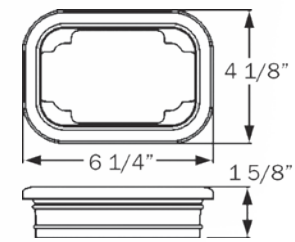

HOLE CUT-OUT: 5.453" x 3.578" (1" R)



A11SRB

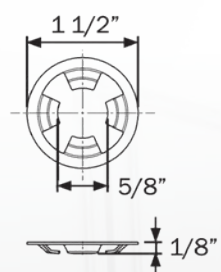

BK20BB



A40SRB

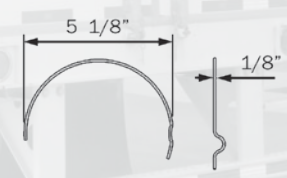

MOUNTING & WIRING ACCESSORIES

MOUNTING GASKETS

Closed Cell Foam Gaskets

Closed cell foam gaskets provide weather tight seal to mounting surface



A13G2B



A17GB



A66GB



A42GB



A90GB

BULK P/N	POLYPACK P/N	DESCRIPTION	QTY
FOAM GASKETS			
A13G2B	A13G2BP	MCL/UCL13 series, black	200
A15GB	A15GBP	MCL15 series, black	50
A17GB	A17GBP	MCL17 series, black	100
A32GB	A32GBP	MC32 series, white	500
A42GB	A42GBP	4" flange mount lights, black	100
A43FMBB	A43FMBBP	Gasket for STL43RBHX	50
A44GTB	A44GTBP	Thick, white	1000
A52GB	A52GBP	MCL52 series, black	100
A66GB	A66GB	MCL66 series, black	100
A69GB	A69GBP	MCL70/STL69 series, black	50
A73GB	A73GBP	STL73, non-adhesive, black	100
A76GB	A76GBP	Gasket for MCL76	100
A90GB	A90GBP	STL90, 5mm, black	50

REPLACEMENT LENSES

BULK P/N	POLYPACK P/N	DESCRIPTION	QTY	P/N	WT/DIMS
REPLACEMENT LENSES					
AL16RB	AL16RBP	Red tail light lens for STL16/17RB/RS and TLL16/160RK	50	AL16RB	.010 lb. / 8.063" x 2.875" x .25"
AL17RB	AL17RBP	Red side marker lens for STL16/17RB/RS and TLL16/160RK	50	AL17RB	.010 lb. / 2.813" x 2.875" x .25"
A2RB	A2RBP	Red side marker lens for ST2/3/4/5	25	A2RB	.020 lb. / 2.75" x 2" x 1.5"
A8RB	A8RBP	Red, tail light lens for ST2/3/4/5/6/7/8/9	50	A8RB	.010 lb. / 4.563" x 4.563" x .25"
A9RB	A9RBP	Red side marker lens for ST6/7/8/9	50	A9RB	.010 lb. / 2.75" x 2.125" x .25"
A10R1B	A10R1BP	Red lens for RVSTL10/11	25	A11AB	.010 lb. / 2." x 1" x .875"
A11AB	A11ABP	Yellow marker lens for MC11	50	A11RB	.010 lb. / 2." x 1" x .875"
A11RB	A11ABP	Red marker lens for MC11	50	A16RB	.020 lb. / 8.063" x 2.875" x .25"
A16RB	A16RBP	Set: Red tail light lens, side marker lens for ST16/17	50	A17RB	.010 lb. / 2.75" x 2.125" x .125"
A17RB	A17RBP	Red side marker lens for ST16/17	50	A24RB	.010 lb. / 4.313" x 4.313" x .5"
A24RB	A24RBP	Red lens for ST24/25	25	A0028AB	.010 lb. / 4" x 2" x .5"
A0028AB	A0028ABP	Yellow lens for MCL0028ABB	50	A0028RB	.010 lb. / 4" x 2" x .5"
A0028RB	A0028RBP	Red lens for MCL0028ABB	50	A31AB	.010 lb. / 4" x 2" x .75"
A31AB	A31ABP	Yellow lens for MC31	50	A31RB	.010 lb. / 4" x 2" x .75"
A31RB	A31RBP	Red lens for MC31	50	A32AB	.010 lb. / 4" x 2" x .5"
A32AB	A32ABP	Yellow lens for MC/MCL32	10	A32RB	.010 lb. / 4" x 2" x .5"
A32RB	A32RBP	Red lens for MC/MCL32	50	A35AEB	.010 lb. / 2.75" x 2" x .5"
A35AEB	A35AEBP	Yellow lens for MC35AEB	50	A36AB	.010 lb. / 2.75" x 2" x .125"
A35RB	A35RBP	Red lens for MC35	50	A36RB	.010 lb. / 2.75" x 2" x .125"
A36AB	A36ABP	Yellow lens for MC36	50	A37RB	.010 lb. / 3.25" x 2" x .125"
A36RB	A36RBP	Red lens for MC36	50	A38AB	.010 lb. / 4" x 2" x .875"
A37RB	A37RBP	Red side marker lens for ST36/37	50	A38RB	.010 lb. / 4" x 2" x .875"
A38AB	A38AB	Yellow lens for MC38	50	A39RB	.020 lb. / 7.75" x 3.25" x .5"
A38RB	A38RB	Red lens for MC38	50	A40RB	.010 lb. / 4.25" x 4.25" x .125"
A39RB	A39RBP	Red tail light lens for ST36/37	10	A41CB	.010 lb. / 4.25" x 4.25" x .125"
A40RB	A40RBP	Red lens for ST40	25	A42AB	.010 lb. / 4" x 2" x .75"
A41CB	A41CBP	Clear lens for BU41	25	A42RB	.010 lb. / 4" x 2" x .75"
A42AB	A42ABP	Yellow lens for MC42	10	A43RB	.010 lb. / 4.25" x 4.25" x .125"
A42RB	A42RBP	Red lens for MC42	10	A44AB	.010 lb. / 4" x 1.5" x .875"
A43RB	A43RBP	Red lens with reflex for ST42	25	A44A500B	.010 lb. / 4" x 1.5" x .875"
A44AB	A44ABP	Yellow lens for MC/MCL44	10	A44RB	.010 lb. / 4" x 1.5" x .875"
A44A500B	-	Yellow lens for MC/MCL44, 500-pack	500	A44R500B	.010 lb. / 4" x 1.5" x .875"
A44RB	A44RBP	Red lens for MC/MCL44	10	A52AB	.010 lb. / 4.313" x 4.313" x .5"
A44R500B	-	Red lens for MC/MCL44, 500-pack	500	A52RB	.010 lb. / 4.313" x 4.313" x .5"
A52AB	A52ABP	Yellow lens for ST52	25	A60RB	.020 lb. / 6.5" x 5.5" x .125"
A52RB	A52RBP	Yellow lens for ST52	25		
A60RB	A60RBP	Red tail light lens for ST60	25		

Continued on the next page →

REPLACEMENT LENSES REPLACEMENT LENSES

P/N	WT/DIMS	BULK P/N	POLYPACK P/N	DESCRIPTION	QTY
REPLACEMENT LENSES					
A66AB	.010 lb. / 4" x 2" x .875"	A66AB	A66ABP	Yellow lens for MC66	50
A66RB	.010 lb. / 4" x 2" x .875"	A66RB	A66RBP	Red lens for MC66	50
A68AB	.010 lb. / 3.5" x 1.125" x .875"	A68AB	A68ABP	Yellow lens for MC68	50
A68RB	.010 lb. / 3.5" x 1.125" x .875"	A68RB	A68RBP	Red lens for MC68	50
A90AB	.020 lb. / 7.125" x 7.125" x 2"	A90AB	A90ABP	Yellow lens for ST90AB	5
A90RB	.020 lb. / 7.125" x 7.125" x 2"	A90RB	A90RBP	Red lens for ST90AB	5
AIL21B	.010 lb. / 5.75" x 4" x 1.75"	AIL21B	AIL21BP	Clear lens for RVILL21/22	10
APL1AB	.010 lb. / 5.875" x 2.5" x .625"	AL9RB	AL9RBP	Red side marker lens for STL8/9	30
APL1CB	.010 lb. / 5.875" x 2.5" x .625"	APL1AB	APL1ABP	Yellow lens for RVPL1/3	10
APL5AB	.010 lb. / 5.5" x 2.75" x .75"	APL1CB	APL1CBP	Clear lens for RVPL1/3	10
APL5CB	.010 lb. / 5.5" x 2.75" x .75"	APL5AB	APL5ABP	Yellow lens for RVPL5/7	10
APL11AB	.010 lb. / 5.5" x 2.75" x .75"	APL5CB	APL5CBP	Clear lens for RVPL5/7	10
APL11CB	.010 lb. / 5.5" x 2.75" x .75"	APLL11AB	APLL11ABP	Yellow lens for RVPLL11AB and RVPLL13AB	200
ARVIL35B	.010 lb. / 4.5" x 4" x .875"	APLL11CB	APLL11CBP	Clear lens for RVPLL11AB and RVPLL13AB	200
AST60B	.020 lb. / 8.625" x 3.125" x 1.875"	ARVIL35B	ARVIL35BP	Clear lens for RVIL35/36	10
AST61B	.020 lb. / 8.625" x 3.125" x 1.875"	AST60B	AST60BP	Red tail passenger light lens for RVST60/61 and RVSTL0060/61	10
 RETAIL					
A8RK				Tail and side marker lens set, clam	12
A8R				Tail light lens, clam	12
A9R				Red side marker lens, clam	12
A16R				Lens set: tail light and side marker, clam	12
A20R				Red lens for ST20/21	12
A36R				Lens set: tail light and side marker, clam	12

SINGLE WIRE PLUG

Wiring/Molded Plug for Marker/Clearance & Utility Lights

- Molded male plug with lead wire
- For use with sealed marker/clearance and utility lights installed in self-grounding base

BULK P/N	POLYPACK P/N	DESCRIPTION	QTY
SINGLE WIRE PLUG			
A91LW	A91LWP	Single wire plug, 12", .156 male	100
A91LRW	A91LRWP	Single wire plug, 7", red, .180 male	500
A61EZPG	A61EZPGP	Single wire, 9" .180 male to .156 male	100
WT	0.044 lb.		



A91LW



A91LRW



A61EZPG

SINGLE & TWO-WIRE PLUGS

Wiring/Molded Plug for Thinline Marker/Clearance & Utility Lights

- Standard .156 male bullet on 6" lead wire
- Molded plug fits into surface mount bracket for MC/MCL/UL/UCL65 and MCL61 series lights
- Single wire plug grounds through mounting hardware
- Two-wire plug includes both lead and ground wire

BULK P/N	POLYPACK P/N	DESCRIPTION	QTY
MOLDED PLUGS FOR THINLINE LIGHTS			
A65P	A65PP	Single wire plug, 6"	50
A68P	A68PP	Two-wire plug, 6"	50
WT	Plugs weigh approximately 0.044 lb. each		



A65P



A68P



A42PMB

2-WIRE PIGTAILS

Wiring/Molded Plugs for Single Contact Sealed Lights

- Standard two terminal plug with male pins, bare lead wire and #10 ring terminal on ground wire
- For use with back-up and utility lights



A45CB

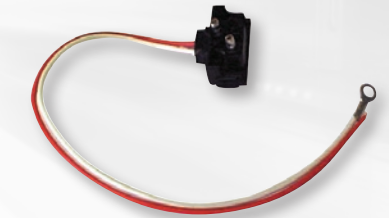

A49PB

BULK P/N	POLYPACK P/N	DESCRIPTION	QTY
TWO-WIRE PIGTAILS			
A42PMB	A42PMBP	Weathertight pigtail, 10"	100
A45CB	A45CBP	Straight pigtail, 10"	100
A49PB	A49PBP	Right angle pigtail, 10"	100
A49PBB	A49PBBP	Right angle pigtail, 6", no eyelet on ground	100
WT		All weigh approximately 0.044 lb. each	

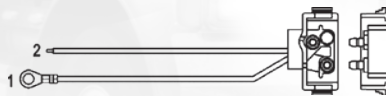

MOUNTING HARDWARE

Mounting Hardware for Vehicle Lighting



Hardware sets for mounting vehicle lights. Components packaged separately.

BULK P/N	POLYPACK P/N	DESCRIPTION	QTY
HARDWARE			
A830B	-	(1) each: 1/4" 20 flange lock nut, 1/4" flat washer, 1/4" split lock washer; stainless steel	100
A839B	-	(1) each: 1/4" 20 flange lock nut, 1/4" flat washer, 1/4" split lock washer; zinc plated	100
BK21BB	BK21BBP	Kit: 3-piece set of mounting brackets and hardware for UCL32CDTB	2
LP52HP	LP52HPP	Mounting hardware for license plate lights; includes two each bolts, washers and weld nuts	100

2-WIRE PIGTAILS

Wiring/Molded Plugs for Sealed Marker/Clearance & Utility Lights

- Pigtails feature standard PL-10 plug with male pins; bare lead wires and #8 ring terminal on ground wire unless noted in description
- For use with sealed marker/clearance and utility lights

BULK P/N	POLYPACK P/N	DESCRIPTION	QTY
TWO-WIRE PL-10 PLUGS			
A12PB	A12PBP	12" adaptor, .180 male bullets to .180 female barrels	100
AL42PB	AL42PBP	MCL42 weathertight pigtail	100
AL42PG	AL42PGP	MCL42 weathertight pigtail, .180 bullets	100
AL421PG	AL421PGP	MCL42 weathertight pigtail, .180 male bullet on power, eyelet on ground	100
A42PMB	A42PMBP	Weathertight pigtail, 10"	100
A46PB	A46PBP	Straight pigtail, 6"	100
A46PBB	A46PBBP	Straight pigtail, 6", no eyelet on ground	100
A46PPG	A46PPGP	Straight pigtail, 6", male plug on power	100
A46P135B	-	Straight pigtail, 135", no ring terminal on ground wire	100
A46P75B	-	Straight pigtail, 75", no ring terminal on ground wire	100
A46P36B	-	Straight pigtail, 36", no ring terminal on ground wire	100
A86PB	A86PBP	Straight pigtail, 18"	100
RETAIL			
A46PS		Straight pigtail, 6", clam	12
WT	All weigh approximately 0.044 lb. each		



AL42PB



A46PB



ID LIGHT BAR HARNESS

Wiring/Molded Plugs for 3-pc Sealed Identification Light Bars

- Standard two terminal plugs with male pins; 65" bare lead wire and #10 ring terminal on 19" ground wire
- For use with identification light bars featuring sealed lights

BULK P/N	POLYPACK P/N	DESCRIPTION	QTY
ID LIGHT BAR HARNESS			
A93PB	A93PBP	ID light bar harness	100
WT	0.4 lb.		



A93PB

3-WIRE PIGTAILS

Wiring/Molded Plugs for Double Contact Sealed Lights



A45PB

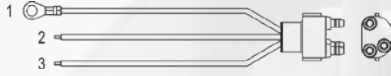

- A45PB & A47PB feature standard PL-3 plug with male pins, bare lead wires and #10 ring terminal on ground wire
- For use with stop/turn/tail, parking/turn and warning lights



A47PB

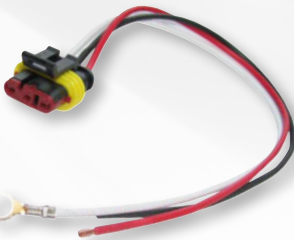

A45PMB

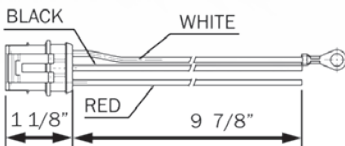

AL45PWTB



BULK P/N	POLYPACK P/N	DESCRIPTION	QTY
STANDARD PL-3			
A45PB	A45PBP	Straight pigtail, 10"	100
A47PB	A47PBP	Right angle pigtail, 10"	100
A47PBB	A47PBBP	Straight pigtail, 10", no eyelet on ground	100
WEATHERPROOF			
A45PMB	A45PMBP	Weathertight plug to bare wire, 10"	50
AL45PWTB	AL45PWTBP	Weathertight plug with female PL-3, 10"	50
AL145PWTB	AL145PWTBP	Weathertight plug, right angle PL-3, 10"	50
RETAIL			
A45PS		Straight pigtail, 6", clam	50
A47PS		Right angle pigtail, 10", clam	50

WT All weigh approximately 0.044 lb. each

TRUNK & TRAILER CONNECTORS

- A10TH5B tongue extension features 5-way flat plug with one female/four male pins on one end; on other end 5-way flat plug with one male/three female pins, female barrel on blue wire
- A4TC4WB and A6TC4WB trunk connectors feature 4-way flat plug with three female/one male pins
- A18TC replacement trailer connector has one female/ three male pins; A185TC has one female/four male pins
- A48TC replacement trunk connector has one male/three female pins



A48TC



A18TC

BULK P/N	POLYPACK P/N	DESCRIPTION	QTY
CONNECTORS			
A10TH5B	A10TH5BP	5-way harness tongue extension, 10-ft	50
A4TC4WB	A4TC4WBP	4-way to bare wire, 4-ft	100
A6TC4WB	A6TC4WBP	4-way to bare wire, 6-ft	50
A6TC5B	A6TC5BP	5-way to bare wire, 6-ft.	50
RETAIL			
A18TC		4-way trailer connector, 18", clam	12
A185TC		5-way trailer connector, 18", clam	12
A48TC		4-way trunk connector, 4-ft, clam	12

7-5 WAY ADAPTORS/PLUGS

BULK P/N	POLYPACK P/N	DESCRIPTION	QTY
7-WAY WIRING HARNESSES			
A7W6FTB	-	7-way molded plug with 6-ft. cable	5
A7W8FTB	-	7-way molded plug with 8-ft. cable	5
7-5 WAY ADAPTORS			
A57WB	A57WBP	5-flat to 7-round, 16" cable	25
A57CCB	A57CCBP	5-flat to 7-round , coil cord	30
A75TB	A75TBP	5-flat to 7-round, single piece	50
A7WCB	A7WCBP	7-way power plug, round	50
RETAIL			
A57WH		5-flat to 7-round, 16" cable, clam	6
A75TC		5-flat to 7-round, single piece, clam	12
A75TC6		5-flat to 7-round, single piece, clam	6



A57WB



A57CCB



A75TB



A7WCB

4-WAY WISHBONE STYLE WIRING HARNESSSES

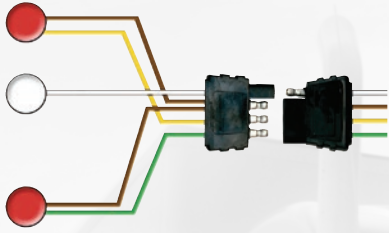

Split wishbone four-conductor harnesses

WIRE DESCRIPTIONS:
 WHITE - GROUND
 BROWN - TAIL LAMPS
 YELLOW - DRIVER SIDE STOP/TURN
 GREEN - PASSENGER SIDE STOP/TURN

BULK P/N	POLYPACK P/N	DESCRIPTION	QTY
4-WAY HARNESSSES			
A20WB	A20WBP	20-ft	50
A25WB	A25WBP	25-ft	50
A25R10WB	A25R10WBP	25-ft, #10 ring terminal on ground	50
A25W42B	A25W42BP	25-ft, 42" ground wire	50
A30WB	A30WBP	30-ft	50
A30W10B	A30W10BP	30-ft, 10-ft ground wire	50
A35WB	A35WBP	35-ft	25
A35R10WB	A35R10WBP	35-ft, #10 ring terminal on ground	25
A35W42B	A35W42BP	35-ft, 42" ground wire	50
A36WRB	A36WRBP	36-ft ribbon wiring harness	25
A40W42B	A40W42BP	40-ft with tubing, 42" ground wire	25
RETAIL			
A25WH		25-ft harness with 4-ft trunk connector, clam	6

5-WAY WISHBONE STYLE WIRING HARNESSSES

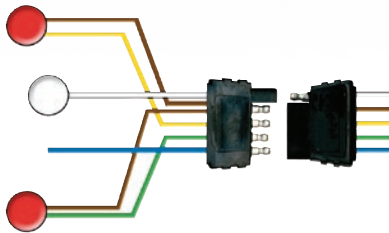

Split wishbone five-conductor harnesses have fifth wire for lights or brakes

WIRE DESCRIPTIONS:
 WHITE - GROUND
 BROWN - TAIL LAMPS
 YELLOW - DRIVER SIDE STOP/TURN
 GREEN - PASSENGER SIDE STOP/TURN
 BLUE - AUXILIARY USE

BULK P/N	POLYPACK P/N	DESCRIPTION	QTY
5-WAY HARNESSSES			
A25W5B	A25W5BP	25-ft, 30" ground, 5-ft blue wire	25
A30W5B	A30W5BP	30-ft, 30" ground, 5-ft blue wire	25
A30W5BLB	-	30-ft, 40" ground, 30-ft blue wire	25
A35W5B	A35W5BP	35-ft, 30" ground, 5-ft blue wire	25
A40W5B	A40W5BP	40-ft, 30" ground, 5-ft blue wire	25
RETAIL			
A255WH		25-ft harness with 4-ft trunk connector, clam	6

REPLACEMENT BULBS

BULK P/N	POLYPACK P/N	DESCRIPTION	QTY
BULBS			
A1157B	A1157BP	1157, 14V 26.9/8.3W, 1200/5000 hour rating	100
A194B	A194BP	194 wedge base, 14V 4CP, 2500 hour rating	100
RETAIL			
A400		Set, (1) each: 2057, 1157, 194, 168; clam	12
A700		12V 55W H3 quartz halogen, clam	12

ALEDRST Series LED Load Resistor

- Upgrade from incandescent turn signals to LED models for safer, cost-efficient lights
- Makes turn signal flash at proper flash rate
- 50W, 6 ohm in-line resistor

BULK P/N	POLYPACK P/N	DESCRIPTION	QTY
LOAD RESISTOR			
ALEDRST1B	ALEDRST1BP	LED load resistor with lead	50
ALEDRST2B	ALEDRST2BP	LED load resistor with lead and female PL-3 plug	50

VOLT/AMP	WARRANTY
12V / 50W	Three Year Warranty

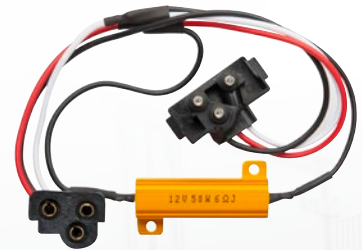
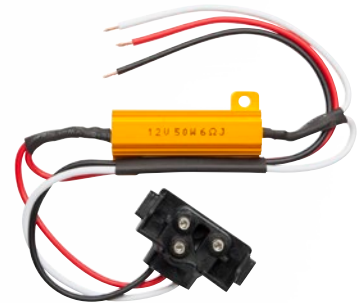

UCL90 SERIES CONNECTORS LED Strip Lighting Connectors

- Connects strips of lights without soldering
- Snap-on design is quick and easy to install
- For use with UCL90/91/92 series

BULK P/N	POLYPACK P/N	DESCRIPTION	QTY
BRACKETS			
A90PB	A90PBP	Snap-on connector with leads	20
A90P1B	A90P1BP	Snap-on connector	20

MATERIALS	Plastic
VOLT/AMP	12.8VDC
WT/DIMS	0.01 lbs. / 1" long
WARRANTY	Three Year Warranty





A0116AWGBLWSB



A011AWGBRGRSB



A011AWGBRSB



A0118AWGBRYLWSB

BULK WIRE

- Bulk wire on spools
- Select from 16AWG or 18AWG in assorted colors

BULK P/N	DESCRIPTION	QTY
BULK WIRE		
A0114AWG2BLWHSB	14AWG, White/Black, 2,500-ft. spool	1
A0114AWGBLKWHTB	14AWG, White/Black, 1,640-ft. spool	1
A0116AWGBLWSB	16AWG, Blue/White, 1,640-ft. spool	1
A0118AWGBRGRSB	18AWG Brown/Green, 1,640-ft. spool	1
A0118AWGBRSB	18AWG, Brown 2,985-ft. spool	1
A0118AWGBRYLWSB	18AWG, Brown/Yellow, 1,640-ft. spool	1
A0118AWGWHTSB	18AWG, White, 2,985-ft. spool	1
A0118AWGBRYLGRB	18AWG, Brown/Yellow/Green, 1,640-ft. spool	1
A0118AWGWHT5KSB	18AWG, White, 5,000-ft. spool	1
A0118AWGBR5KSB	18AWG, Brown 5,000-ft. spool	1
A0118AWGBRGR5KSB	18AWG Brown/Green, 5,000-ft. spool	1
A0118AWGRESB	18AWG, Red 5,000-ft. spool	1
A0118AWGBLSB	18AWG, Black 5,000-ft. spool	1
A0118AWGYESB	18AWG, Yellow 5,000-ft. spool	1
A0118AWGBRRE5KSB	18AWG Brown/Red, 5,000-ft. spool	1
A0118AWGGRSB	18AWG, Green, 5,000-ft. spool	1
A0118AWGRESB	18AWG, Red, 5,000-ft. spool	1



A0118AWGWHTSB



FLASHER

BULK P/N	POLYPACK P/N	DESCRIPTION	QTY
FLASHER			
ALEDFB	ALEDFBP	LED flasher with connectors	10
RETAIL			
ALEDFS		LED flasher with connections, clam	12

DOCUMENT HOLDER

- Twist-on cover with gasket protects documents from dirt and moisture while allowing convenient access
- Easy installation

BULK P/N	POLYPACK P/N	DESCRIPTION	QTY
DOCUMENT HOLDER			
DH55	DH55P	Document holder	10
ADH55B	ADH55BP	Replacement lid	50

P/N	MATERIALS	WT/DIMS
DH55	Polycarbonate	0.46 lb. / 5.5" x 5.5" x 2.125"



DH55



MOUNTING & WIRING ACCESSORIES

FMVSS LIGHTING REQUIREMENTS – TRAILERS

FEDERAL LIGHTING REGULATIONS FOR TRAILERS

IMPORTANT NOTE: Every lamp, reflex reflector, and conspicuity treatment must be permanently attached in the location specified below and must comply with all applicable requirements prescribed for it by FMVSS/CMVSS 108. The face of any device on the front/rear and sides should be, respectively perpendicular and parallel to the vehicle's centerline, unless it is photometrically certified at installation angle. No part of the vehicle shall prevent any device from meeting its prescribed requirements unless an auxiliary device meeting all prescribed requirements is installed. **IN CANADA:** Manufacturers and importers of vehicles must have the proper certification test records demonstrating compliance of lighting components with all prescribed requirements.



BASIC EQUIPMENT REQUIRED ON ALL TRAILERS

DESCRIPTION				MANDATORY REQUIREMENTS			
Area	Equipment	SAE Lens Coding	Functional Purpose	Quantity	Color	Location	Height mm (in.) from the ground
1	Tail Lamps	(T)	Indicate vehicle's presence and width	Minimum 2	Red	On the rear - symmetrical as far apart as practicable	380-1830 (15-72)
	Stop Lamps	(S)	Indicate braking	Minimum 2	Red	On the rear - symmetrical as far apart as practicable	380-1830 (15-72)
	Rear Turn Signal Lamps	(I)	Indicate direction of turn	Minimum 2	Red or Yellow	On the rear - symmetrical as far apart as practicable	380-2110 (15-83)
	Rear Reflex Reflectors	(A)	Indicate vehicle's presence and width	Minimum 2	Red	On the rear - symmetrical as far apart as practicable facing rearward	380-1530 (15-60)
2	License Plate Lamp(s)	(L)	Illuminates license plate	Minimum 1	White	On the rear - above or at the sides of license plate	No requirement
3	Rear Side Marker Lamps <small>*photometrically certified at installation angle</small>	(P2, PC* or P3, PC2*)	Front and rear side marker lamps / side reflex reflectors indicate vehicle's presence and length	Minimum 2	Red	Each side at rear as far back as practicable	380-1530 (15-60) no max. for veh. under 2032mm (80") wide
	Rear Side Reflex Reflectors	(A)		Minimum 2	Red	Each side at rear as far back as practicable facing sideward	380-1530 (15-60)
4	a Front Side Marker Lamps <small>*photometrically certified at installation angle</small>	(P2, PC* or P3, PC2*)	Front and rear side marker lamps / side reflex reflectors indicate vehicle's presence and length	Minimum 2	Yellow	Each side at front as far forward as practicable	380 (15) minimum
	b Front Side Reflex Reflectors	(A)		Minimum 2	Yellow	Each side at front as far forward as practicable facing sideward	380-1530 (15-60)

ADDITIONAL EQUIPMENT FOR TRAILERS EXCEEDING THE FOLLOWING PARAMETERS

Length 9.1m (30 ft.) or longer

DESCRIPTION				MANDATORY REQUIREMENTS			
Area	Equipment	SAE Lens Coding	Functional Purpose	Quantity	Color	Location	Height mm (in.) from the ground
5	a Intermediate Side Marker Lamps	(P2 or P3)	Indicate presence of a long vehicle	Minimum 2	Yellow	Each side near center facing sideward	380 (15) minimum
	b Intermediate Side Reflex Reflectors	(A)	Indicate presence of a long vehicle	Minimum 2	Yellow	Each side near center facing sideward	380-1530 (15-60)

Width 2032mm (80 in.) or wider

DESCRIPTION			MANDATORY REQUIREMENTS				
Area	Equipment	SAE Lens Coding	Functional Purpose	Quantity	Color	Location	Height
6	Rear Clearance Lamps <small>*photometrically certified at installation angle</small>	(P2, PC* or P3, PC2*)	Show vehicle's width MAY NOT be combined with tail lamps	Minimum 2	Red	At widest point - symmetrical on the rear or near the rear facing rearward	As high as practicable may be lower only if ID lamps are at the top
7	Rear Identification (ID) Lamps	(P2 or P3)	Indicate presence of a wide vehicle	Exactly 3	Red	On the rear - center horizontally spaced 150mm (6 in.) to 300mm (12 in.) apart facing rearward	At the top - may be lower if door header narrower than 25mm
8	Front Clearance Lamps <small>*photometrically certified at installation angle</small>	(P2, PC* or P3, PC2*)	Show vehicle's width	Minimum 2	Yellow	At widest point - symmetrical on the front or near the front facing forward	As high as practicable

Width 2032mm (80 in.) or wider AND GVWR 4536 kg (10,000 lb.) or more

DESCRIPTION		MANDATORY REQUIREMENTS					
Area	Conspicuity Treatment	DOT Coding	Quantity	Color	Location	Height	Options
9	Rear Upper Body Markings	DOT-C DOT-C2 DOT-C3 DOT-C4	Exactly 2 pairs of 300mm long strips	White	On the rear upper corners facing rearward	At the top	Reflex reflectors may not be required if they are replaced in their required location with conspicuity treatment. Optional in Canada: Rear lower body and side conspicuity treatment may also be solid white, solid yellow, or white and yellow.
10	Bumper Bar Marking		Continuous	Red/White	On the rear bumper bar's horizontal element full width - facing rearward	No requirement	
11	Rear Lower Body Marking		Continuous	Red/White (see options)	On the rear full width of the vehicle facing rearward	As horizontal as practicable and as close as practicable to the range of 375 to 1525mm from the ground	
12	Side Marking		(see location)	Red/White (see options)	Each side - facing sideward continuous, or evenly spaced over minimum of 50% of length starts and ends as close to the front and rear of the vehicle as practicable	As horizontal as practicable and as close as practicable to the range of 375 to 1525mm from the ground	

NOTE: The edge of red conspicuity tape shall not be closer than 75 mm to the edge of any amber lamp and the edge of white conspicuity tape shall not be closer than 75 mm to the edge of any lamp

FMVSS LIGHTING REQUIREMENTS – TRAILERS

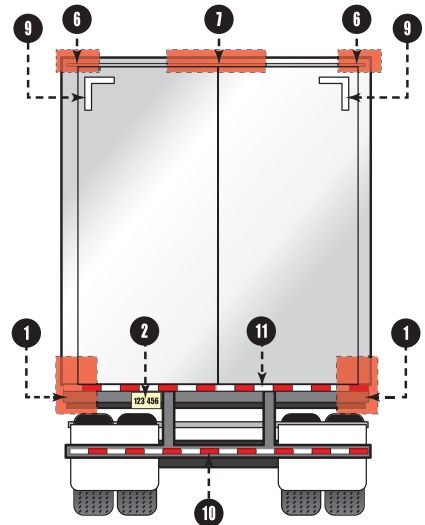
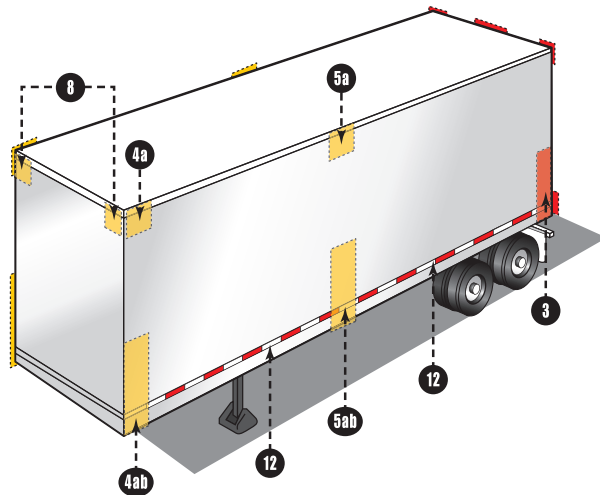
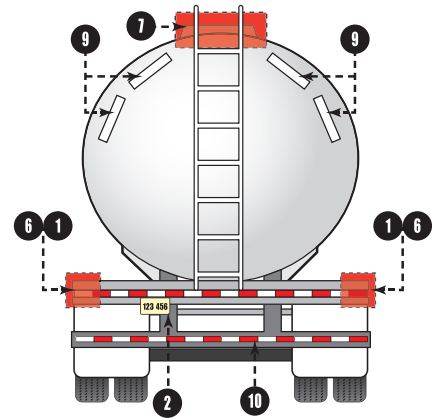
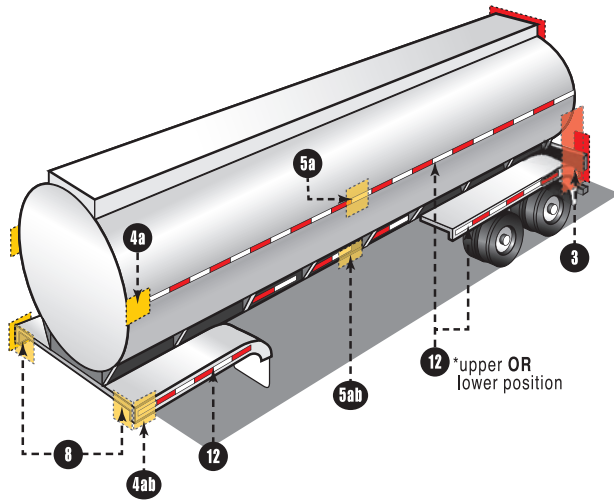
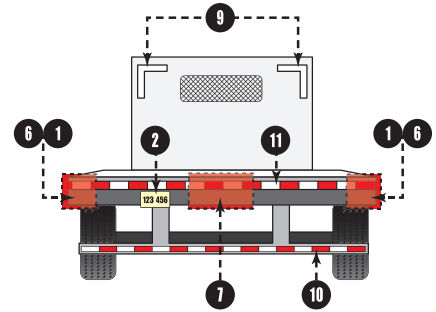
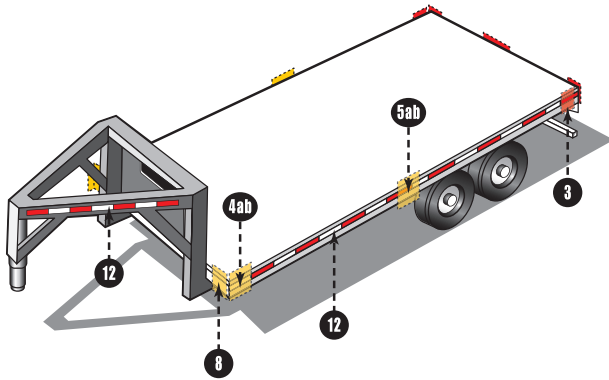
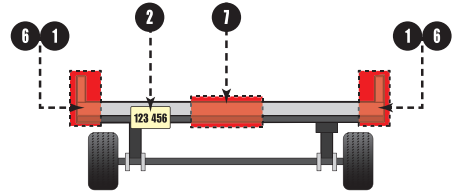
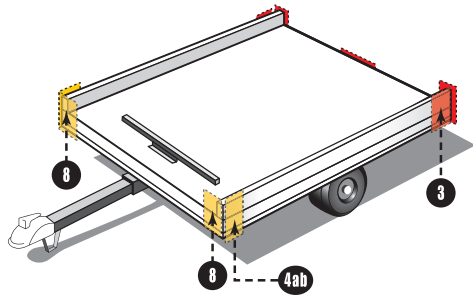

FMVSS LIGHTING REQUIREMENTS – TRAILERS

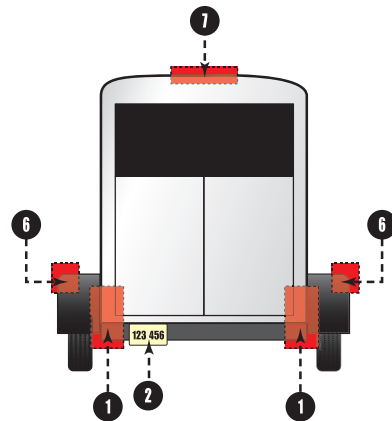
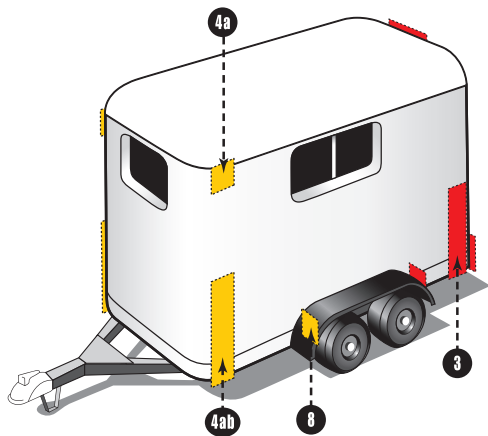
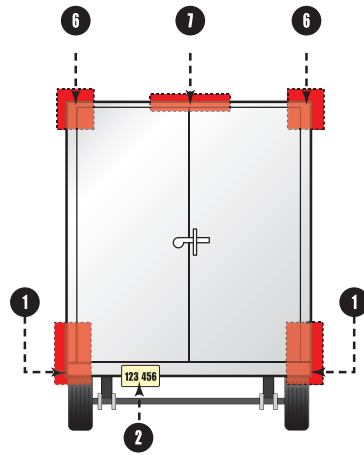
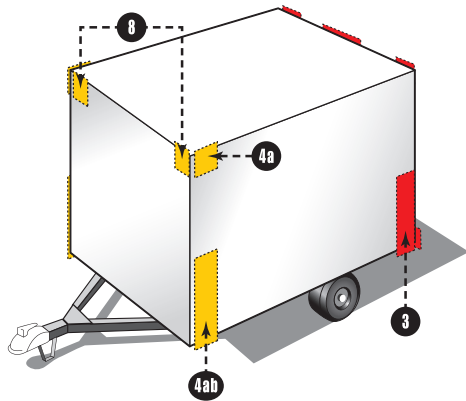
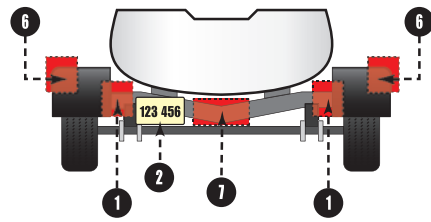
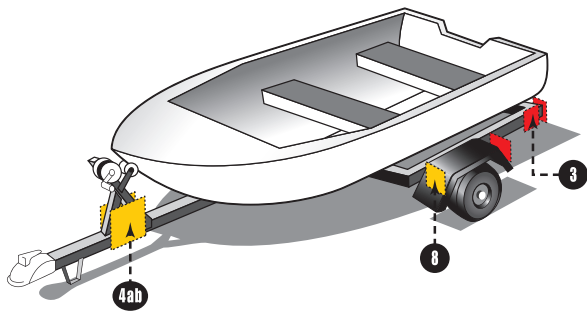
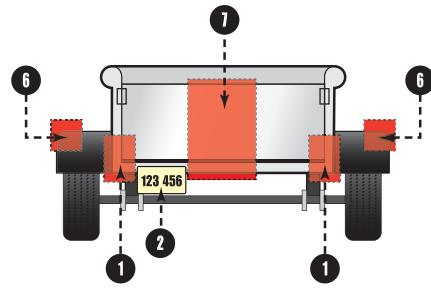
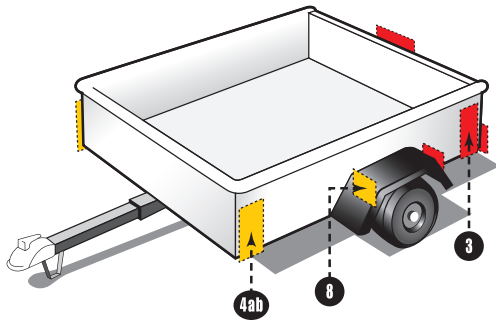

FMVSS LIGHTING REQUIREMENTS – TRUCKS/BUSES/MPV'S

FEDERAL LIGHTING REGULATIONS FOR TRUCKS, BUSES & MPVS

IMPORTANT NOTE: Every lamp, reflex reflector, and conspicuity treatment must be permanently attached in the location specified below and must comply with all applicable requirements prescribed for it by FMVSS/CMVSS 108. The face of any device on the front/rear and sides should be, respectively perpendicular and parallel to the vehicle's centerline, unless it is photo-metrically certified at installation angle. No part of the vehicle shall prevent any device from meeting its prescribed requirements unless an auxiliary device meeting all prescribed requirements is installed. **IN CANADA:** Manufacturers and importers of vehicles must have the proper certification test records demonstrating compliance of lighting components with all prescribed requirements.



BASIC EQUIPMENT REQUIRED ON ALL TRUCKS, BUSES & MPVS

DESCRIPTION				MANDATORY REQUIREMENTS			
Area	Equipment	SAE Lens Coding	Functional Purpose	Quantity	Color	Location	Height mm(in.) from the ground
1	Headlamps – Lower Beam <small>US requires "DOT" lettering on lens US & Canada - light source code required on lens</small>	(H, HR)	Forward road illumination	Minimum 2	White	On the front - symmetrical as far apart as practicable <small>If 4 lamp system - outboard or above upper beams</small>	560-1370 (22-54)
	Headlamps – Upper Beam <small>US requires "DOT" lettering on lens US & Canada - light source code required on lens</small>	(H, HR)	Forward road illumination	Minimum 2	White	On the front - symmetrical <small>If 4 lamp system - inboard or below lower beams</small>	560-1370 (22-54)
	Parking Lamps <small>Vehicles less than 2032mm wide</small>	(P)	Indicate parked vehicle	Minimum 2	White or Yellow	On the front - symmetrical as far apart as practicable	380-1830 (15-72)
	Daytime Running Lamps (DRL) <small>Canada - required / US - option US requires "DRL" lettering on lens if not headlamp</small>	(Y2)	Indicate in use vehicle	Minimum 2	White or Yellow	On the front - symmetrical as far apart as practicable	380 (15) min. <small>Max depends on type of DRL</small>
	Front Turn Signal/ Hazard Warning Lamps	(I)	Indicate direction of turn/ identify disabled vehicle	Minimum 2	Yellow	On the front - symmetrical as far apart as practicable	380-2110 (15-83)
2	Front Clearance Lamps <small>Vehicles 2032mm wide or wider *photometrically certified at installation angle</small>	(P2, PC* or P3, PC2*)	Show vehicle's width	Minimum 2	Yellow	At widest point - symmetrical on the front or near the front facing forward	As high as practicable
3	Front Identification Lamps (ID) <small>Vehicles 2032mm wide or wider</small>	(P2 or P3)	Indicate presence of a wide vehicle	Exactly 3	Yellow	On the front - center horizontally spaced 150mm (6 in.) to 300mm (12 in.) apart	As high as practicable or on top of the cab
4	a Front Side Marker Lamps <small>*photometrically certified at installation angle</small>	(P2, PC* or P3, PC2*)	Front and rear side marker lamps / side reflex reflector indicate vehicle's presence and length	Minimum 2	Yellow	Each side at front as far forward as practicable	380 (15) minimum
	b Front Side Reflex Reflectors	(A)		Minimum 2	Yellow	as far forward as practicable facing sideward	380-1530 (15-60)
5	a Rear Side Marker Lamps** <small>*photometrically certified at installation angle</small>	(P2, PC* or P3, PC2*)	Rear side marker lamps / side reflex reflector indicate vehicle's presence and length	Minimum 2	Red	Each side at rear as far back as practicable	380 (15) minimum
	b Rear Side Reflex Reflectors** <small>**not required on Truck Tractors</small>	(A)		Minimum 2	Red	Each side at rear as far back as practicable facing sideward	380-1530 (15-60)
6	Rear Clearance Lamps <small>Vehicles 2032mm wide or wider Not required on Truck Tractors *photometrically certified at installation angle</small>	(P2, PC* or P3, PC2*)	Show vehicle's width MAY NOT be combined with tail lamps	Minimum 2	Red	At widest point - symmetrical on the rear or near the rear facing rearward	As high as practicable may be lower only if rear ID lamps are at the top
7	Rear Identification (ID) Lamps <small>Vehicles 2032mm wide or wider Not required on Truck Tractors</small>	(P2 or P3)	Indicate presence of a wide vehicle	Exactly 3	Red	On the rear - center horizontally spaced 150mm (6 in.) to 300mm (12 in.) apart facing rearward	At the top - may be lower if door header narrower than 25mm
8	Tail Lamps	(T)	Indicate vehicle's presence and width	Minimum 2	Red	On the rear - symmetrical as far apart as practicable	380-1830 (15-72)
	Stop Lamps	(S)	Indicate braking	Minimum 2	Red	On the rear - symmetrical as far apart as practicable	380-1830 (15-72)
	Rear Turn Signal/ Hazard Warning Lamps	(I)	Indicate direction of turn/ identify disabled vehicle	Minimum 2	Red or Yellow	On the rear - symmetrical as far apart as practicable	380-2110 (15-83)
	Rear Reflex Reflectors	(A)	Show vehicle's presence and width	Minimum 2	Red	On the rear - symmetrical as far apart as practicable	380-1530 (15-60)
9	Backup Lamp	(R)	Illuminates ground behind the vehicle and alert road users	Minimum 1	White	Rear	No requirement
10	License Plate Lamp(s)	(L)	Illuminates license plate	Minimum 1	White	On the rear - above or at the sides of license plate	No requirement
11	Center High Mounted Stop Lamp <small>Vehicles less than 2032mm wide and 4536kg</small>	(U3)	Indicates braking	1	Red	On the rear - centerline of the vehicle	860 (34) minimum

ADDITIONAL EQUIPMENT FOR SPECIFIC VEHICLES VEHICLES 9.1m (30 ft.) LONG OR LONGER

DESCRIPTION				MANDATORY REQUIREMENTS			
Area	Equipment	SAE Lens Coding	Functional Purpose	Quantity	Color	Location	Height mm(in.) from the ground
12	a Intermediate Side Marker Lamps	(P2 or P3)	Indicate presence of a long vehicle	Minimum 2	Yellow	Each side near center	380 (15) minimum
	b Intermediate Side Reflex Reflectors	(A)	Indicate presence of a long vehicle	Minimum 2	Yellow	Each side near center facing sideward	380-1530 (15-60)

Truck Tractors

DESCRIPTION		MANDATORY REQUIREMENTS					
Area	Conspicuity Treatment	DOT Coding	Quantity	Color	Location	Height	Options
13	Rear Upper Body Markings	DOT-C DOT-C2 DOT-C3 DOT-C4	Exactly 2 pairs of 300mm long strips	White	Rear upper corners of cab facing rearward	As high as practicable excluding fairings	
14	Rear Marking		Exactly 2 sections of min. 600mm each	Red/White	Rear - facing rearward - on fenders, on mud flap brackets, or within 300mm below the top of mud flaps	As horizontal as practicable and not higher than 1525mm from the ground	If mud flaps not used - on the cab or frame mounted brackets

NOTE: The edge of red conspicuity tape shall not be closer than 75 mm to the edge of any amber lamp and the edge of white conspicuity tape shall not be closer than 75 mm to the edge of any lamp

For more information contact: Transport Canada: Motor Vehicle Safety Enforcement Branch
National Highway Traffic Safety Administration: Office of Safety Performance Standards

FMVSS LIGHTING REQUIREMENTS – TRUCKS/BUSES/MPV'S

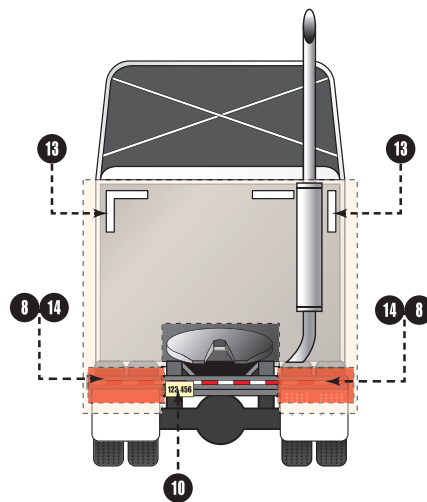
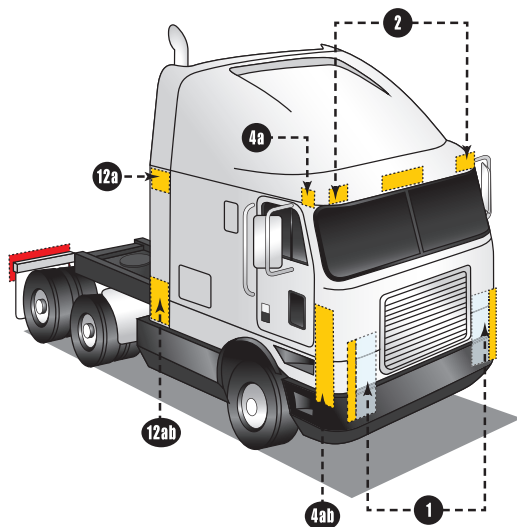
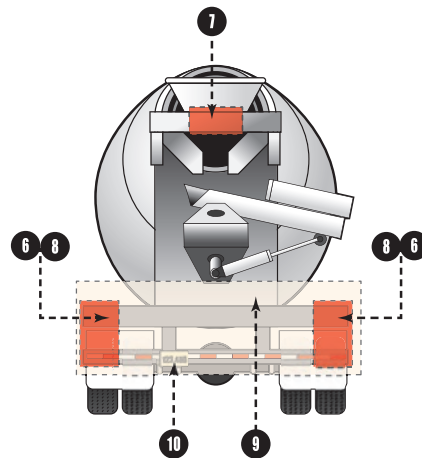
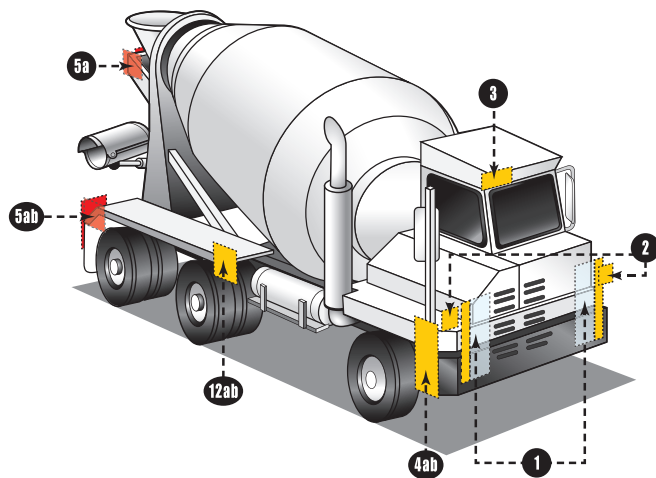
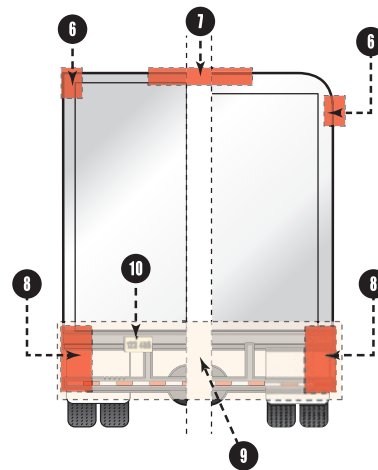
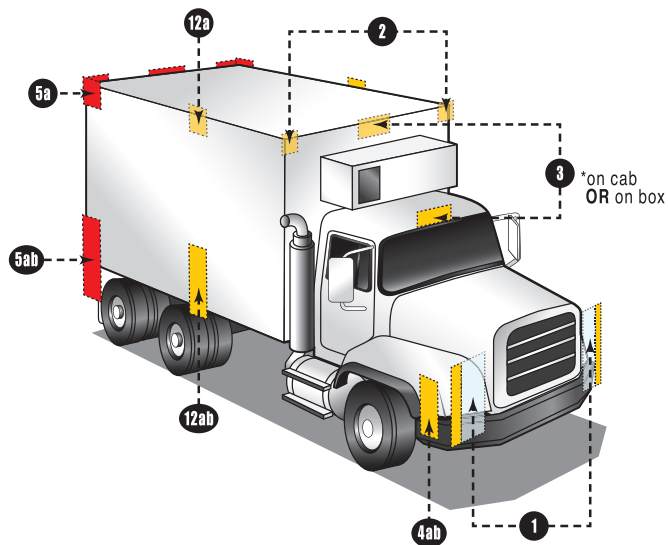

FMVSS LIGHTING REQUIREMENTS – TRUCKS/BUSES/MPV'S

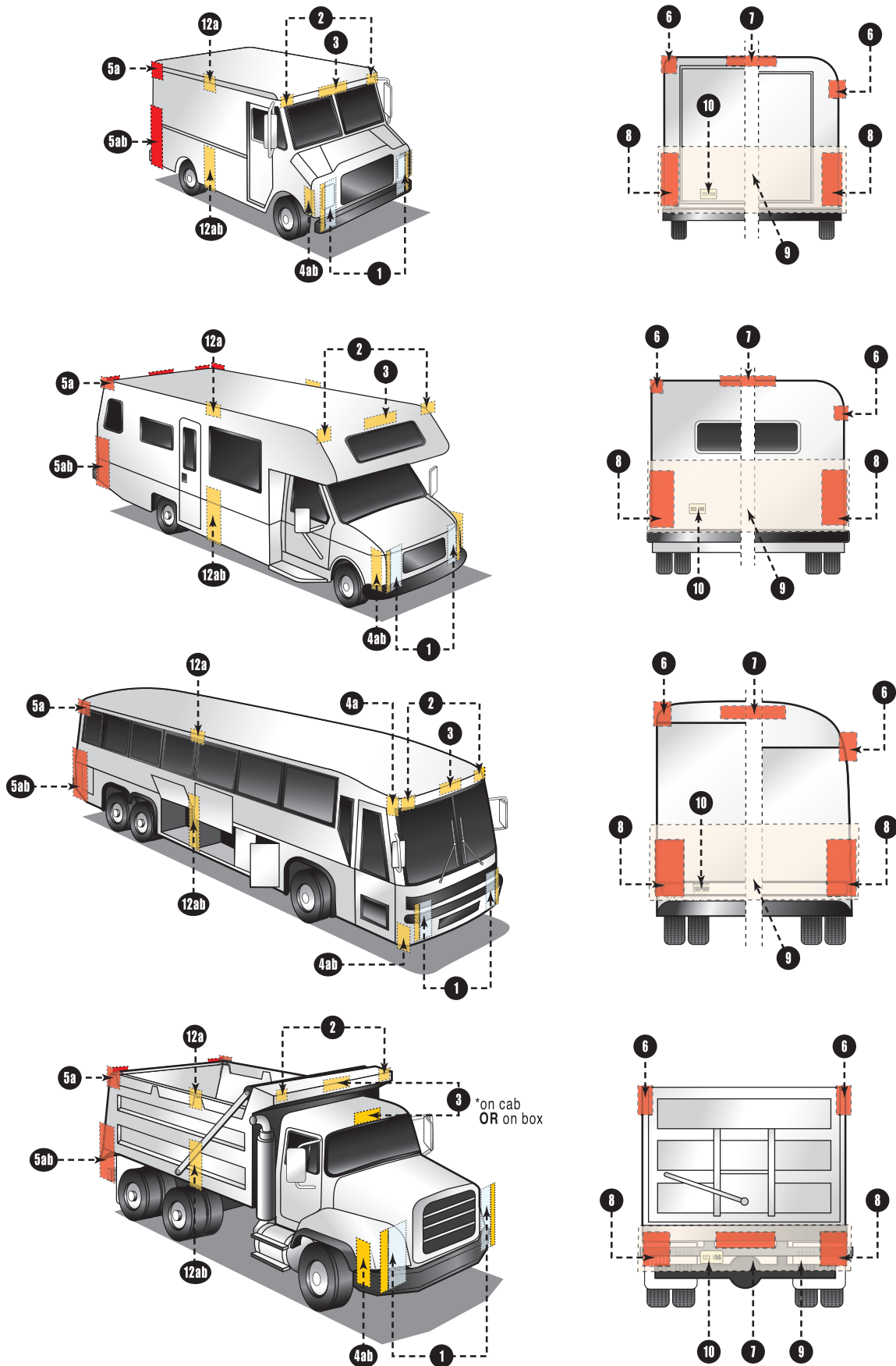

Truck & Trailer Regulation – FMVSS 108 (49CFR 571.108)

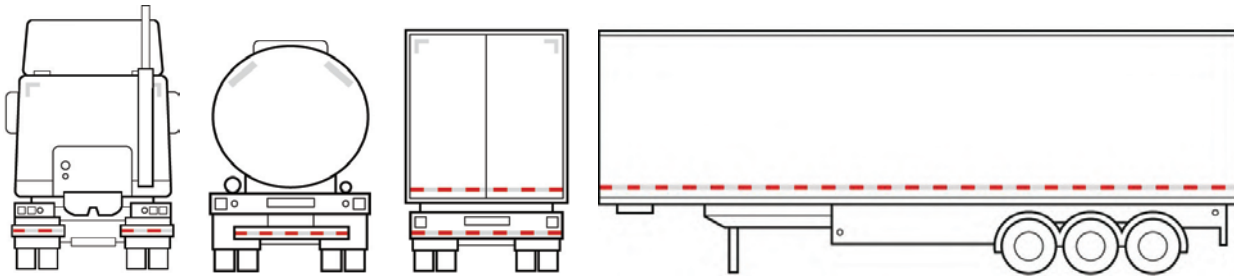

APPLICATION LOCATIONS:

Rear Upper Body

12" WHITE strips placed in the upper rear corners

Rear Lower Body

- 2" wide RED/WHITE tape placed on rear full width of vehicle
- 2" wide RED/WHITE tape minimum 24" length on fender, mudflap brackets or within 12" below the top of mudflaps

Side Marking

2" wide RED/WHITE tape placed on each side of trailer continuous or evenly spaced over 50% of the vehicle



School Bus Regulation – FMVSS 131 & 217

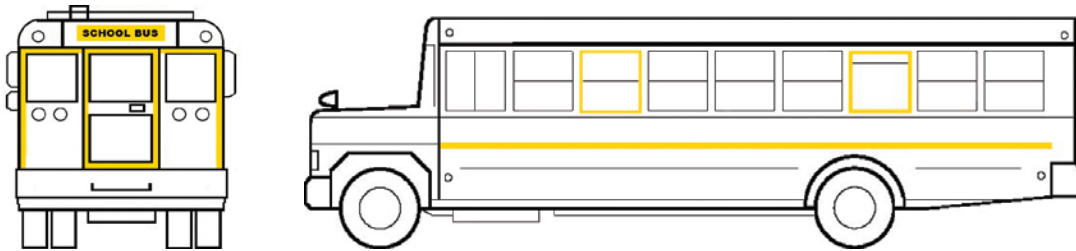

Each opening for a required emergency exit shall be outlined around its outside perimeter with a retroreflective tape with a minimum width of 1 inch and either red, white, or yellow in color, that when tested under the conditions specified in S6.1 of Standard No. 131 (49 CFR 571.131), meets the criteria specified.

APPLICATION LOCATIONS:

- 1" strips used to mark side emergency exit windows
- 1" strips used to mark back emergency exit windows



INDEX

00212104B	106	00212378B	104	068WMTE	309	193G	319
00212117B	341	00212386B	104	068WMTEP	309	193P	319
00212127P	341	00212700B	107	09017101B	322	24004002B	312
00212135P	106	00212701B	107	09017101P	322	240047171B	312
00212137P	106	00212702B	107	105500SP	317	240047171LB	312
00212155P	106	00212703B	107	105520B	317	240047171P	312
00212157P	106	00212704P	107	105520BP	317	24004TR71	312
00212207B	105	00212705P	107	11212207B	102	24004TR71P	312
00212209B	105	00212706P	107	11212209B	102	240147171B	312
00212213B	105	00212707P	107	11212235P	102	240147171LB	312
00212217B	341	00212708P	107	11212236P	102	240147171P	312
00212227P	341	00212709P	107	11212237P	102	24014TR71	312
00212233B	251	00212710P	107	11212238P	102	24014TR71P	312
00212233P	251	00212711P	107	11212255P	102	24074B	310
00212235P	105	00212712P	107	11212256P	102	24074P	310
00212236P	105	00212717B	341	11212257P	102	2407764B	310
00212237P	105	00212727P	341	11212258P	102	2407764P	310
00212238P	105	01180071B	321	11212276B	102	2407765B	310
00212239B	251	01180071P	321	11212278B	102	2407765P	310
00212239P	251	01180089B	321	11212307B	101	2407771C	310
00212251B	251	01180089P	321	11212309B	101	2407771CP	310
00212251P	251	01180090B	321	11212335P	101	2409171B	322
00212253B	251	01180090BP	321	11212336P	101	2409171BP	322
00212253P	251	014BCRCW	320	11212337P	101	24113160B	318
00212255P	105	014BCRCWP	320	11212338P	101	24113160P	318
00212256P	105	03001175B	311	11212355P	101	2500128B	321
00212257P	105	03001175P	311	11212356P	101	2500128P	321
00212258P	105	04010040B	311	11212357P	101	2500171B	321
00212263P	105	04010040P	311	11212358P	101	2500171P	321
00212276B	105	04440013B	310	11212376B	101	2500189B	321
00212278B	105	04440013P	310	11212378B	101	2500189P	321
00212307B	104	04440016B	310	11212700B	103	30000000B	322
00212309B	104	04440016P	310	11212700BB	103	30031010B	322
00212316B	104	06001001B	316	11212700BBP	103	302B	322
00212317B	341	06001001P	316	11212701B	103	302P	322
00212327P	341	06001013B	314	11212702B	103	30655010B	322
00212331B	250	06001013P	314	11212703B	103	3202B	322
00212331P	250	06001014B	314	11212704P	103	3202P	322
00212333B	250	06001014P	314	11212705P	103	357B	318
00212333P	250	06001015B	315	11212706P	103	357P	318
00212335P	104	06001015P	315	11212707P	103	3801071BZL	314
00212336P	104	06001022B	312	11212708P	103	3801071BZLP	314
00212337P	104	06001022P	312	11212709P	103	3802071BZL	314
00212338P	104	06001026B	315	11212710P	103	3802071BZLP	314
00212342B	250	06001026P	315	11212711P	103	500302B	322
00212342P	250	06001037B	315	13000018B	320	500302P	322
00212345P	104	06001037P	315	13000018P	320	510001B	322
00212346P	104	06001048B	315	1502B	322	510001P	322
00212347P	104	06001048P	315	1502P	322	530002B	322
00212351B	250	06001061B	315	15202B	322	530002P	322
00212351P	250	06001061P	315	15202P	322	69000201B	319
00212355P	104	06001072B	315	16802B	309	69000201P	319
00212356P	104	06001072P	315	16802LB	309	69000300B	319
00212357P	104	060102B	316	16802P	309	69000300P	319
00212358P	104	060102P	316	18543910B	317	725022B	314
00212362B	250	0601B	316	18543916B	317	725022P	314
00212362P	250	0601P	316	18543916BP	317	726022B	314
00212365P	104	06300004B	316	19102B	309	726022P	314
00212367P	104	06300004P	316	19102P	309	7850NFRC	320
00212368P	104	068NME	309	193BSP	319	7850NFRCP	320
00212376B	104	068NMEP	309	193BSPP	319	825LED	313

825TRO2.....	313	A11DBP.....	329	A20WBP.....	354	A36RB.....	347
825TRO2P.....	313	A11G1B.....	329	A211CB1.....	336	A36RBP.....	347
826L.....	313	A11G1BP.....	329	A211NCCB.....	336	A36WRB.....	354
826LED.....	313	A11GB.....	329	A211RXB.....	336	A36WRBP.....	354
826LEDP.....	313	A11GBP.....	329	A21AB.....	262	A37RB.....	347
826LP.....	313	A11GLPB.....	329	A21CHB.....	343	A37RBP.....	347
826TRO2.....	313	A11GLPBP.....	329	A21CHBP.....	343	A38AB.....	347
826TRO2P.....	313	A11GSDB.....	329	A21RB.....	262	A38ABP.....	347
826TR12.....	313	A11PB.....	329	A21RBP.....	262	A38RB.....	347
826TR12P.....	313	A11PBP.....	329	A24RB.....	347	A38RBP.....	347
826TR90.....	313	A11RB.....	347	A24RBP.....	347	A39RB.....	347
A0028AB.....	347	A11RBP.....	347	A255WH.....	354	A39RBP.....	347
A0028CRB.....	342	A11RXB.....	324	A25GB.....	339	A3TRSSB.....	330
A0028RB.....	347	A11RXBP.....	324	A25GBP.....	339	A3TRSSBP.....	330
A0114AWG2BLWHSB....	356	A11SRB.....	345	A25R10WB.....	354	A400.....	355
A0114AWGBLKWHTB....	356	A11SRBP.....	345	A25R10WBP.....	354	A40RB.....	347
A0116AWGBLWSB.....	356	A11SSB.....	329	A25TRSSB.....	332	A40RBP.....	347
A0118AWGBLSB.....	356	A11SSBP.....	329	A25TRSSBP.....	332	A40SRB.....	345
A0118AWGBR5KSB.....	356	A12B2LPB.....	329	A25W42B.....	354	A40SRBP.....	345
A0118AWGBRGR5KSB..	356	A12B2LPBP.....	329	A25W42BP.....	354	A40W42B.....	354
A0118AWGBRGR5KSB..	356	A12GB.....	329	A25W5B.....	354	A40W42BP.....	354
A0118AWGBRGR5KSB..	356	A12GBP.....	329	A25W5BP.....	354	A40W5B.....	354
A0118AWGBR5KSB.....	356	A12GLPB.....	329	A25WB.....	354	A40W5BP.....	354
A0118AWGBR5KSB.....	356	A12GLPBP.....	329	A25WBP.....	354	A41CB.....	347
A0118AWGBR5KSB.....	356	A12PB.....	351	A25WH.....	354	A41CBB.....	343
A0118AWGBR5KSB.....	356	A12PBP.....	351	A2CBGB.....	330	A41CBP.....	347
A0118AWGGR5KSB.....	356	A13B210B.....	342	A2RB.....	347	A41CRB.....	343
A0118AWGGR5KSB.....	356	A13B2B.....	342	A2RBP.....	347	A42AB.....	347
A0118AWGGR5KSB.....	356	A13B2BP.....	342	A30W10B.....	354	A42ABP.....	347
A0118AWGWHT5KSB....	356	A13C210B.....	342	A30W10BP.....	354	A42GB.....	346
A0118AWGWHT5KSB....	356	A13C210BP.....	342	A30W5B.....	354	A42GBP.....	346
A0118AWGWHT5KSB....	356	A13C2B.....	342	A30W5BLB.....	354	A42PMB.....	350
A0118AWGWHT5KSB....	356	A13C2BP.....	342	A30W5BP.....	354	A42PMBP.....	350
A06TR.....	342	A13G2B.....	346	A30WB.....	354	A42RB.....	347
A06TRP.....	342	A13G2BP.....	346	A30WBP.....	354	A42RBP.....	347
A09BB.....	342	A13NCC2B.....	342	A31AB.....	347	A43FMBB.....	346
A09BBP.....	342	A13NCC2BP.....	342	A31ABP.....	347	A43RB.....	347
A09CB.....	342	A14GB.....	329	A31RBP.....	347	A43RBP.....	347
A09CBP.....	342	A14GBP.....	329	A32AB.....	347	A44A500B.....	347
A09WB.....	342	A15CB.....	342	A32ABP.....	347	A44AB.....	347
A09WBP.....	342	A15CBP.....	342	A32ABP.....	347	A44ABP.....	347
A101TRSSB.....	334	A15CGB.....	342	A32GB.....	346	A44GTB.....	346
A101TRSSBP.....	334	A15GB.....	346	A32GBP.....	346	A44GTBP.....	346
A10BB.....	329	A15GBP.....	346	A32RB.....	347	A44R500B.....	347
A10BBP.....	329	A16R.....	348	A32RBP.....	347	A44RB.....	347
A10GB.....	329	A16RB.....	347	A33GB.....	345	A44RBP.....	347
A10GBP.....	329	A16RBP.....	347	A33GBP.....	345	A45BB.....	333
A10R1B.....	347	A178TRSSB.....	336	A35AEB.....	347	A45BBP.....	333
A10TH5B.....	353	A178TRSSBP.....	336	A35AEBP.....	347	A45CB.....	350
A10TH5BP.....	353	A17CB.....	343	A35R10WB.....	354	A45CBP.....	350
A111TRSSB.....	336	A17GB.....	346	A35R10WBP.....	354	A45CGB.....	334
A111TRSSBP.....	336	A17GBP.....	346	A35RB.....	347	A45CGBP.....	334
A1157B.....	355	A17RB.....	347	A35W42B.....	354	A45GB.....	333
A1157BP.....	355	A17RBP.....	347	A35W42BP.....	354	A45GBP.....	333
A11AB.....	347	A185TC.....	353	A35W5B.....	354	A45PB.....	352
A11ABP.....	347	A18TC.....	353	A35W5BP.....	354	A45PBP.....	352
A11AXB.....	324	A194B.....	355	A35WB.....	354	A45PMB.....	352
A11AXBP.....	324	A194BP.....	355	A35WBP.....	354	A45PMBP.....	352
A11BLPB.....	329	A19CB.....	343	A36AB.....	347	A45PS.....	352
A11BLPBP.....	329	A20R.....	348	A36ABP.....	347	A45SB.....	333
A11CRB.....	329	A20WB.....	354	A36R.....	348	A45SBP.....	333
A11CRBP.....	329						
A11DB.....	329						

INDEX

A46GB.....	333	A60GB.....	335	A70GBDP.....	335	A91GZB.....	337
A46GBP.....	333	A60GBP.....	335	A70GBP.....	335	A91GZBP.....	337
A46P135B.....	351	A60RB.....	347	A71C1BAWN.....	344	A91LRW.....	349
A46P36B.....	351	A60RBP.....	347	A71CBAWN.....	344	A91LRWP.....	349
A46P75B.....	351	A61EZPG.....	349	A71CBAWNP.....	344	A91LW.....	349
A46PB.....	351	A64BB.....	343	A71CCBWAN.....	344	A91LWP.....	349
A46PBB.....	351	A64BBP.....	343	A73GB.....	346	A91OB.....	337
A46PBBP.....	351	A64CRB.....	343	A73GBP.....	346	A91OBP.....	337
A46PBP.....	351	A65B.....	338	A75TB.....	353	A91RB.....	260
A46PPG.....	351	A65BP.....	338	A75TBP.....	353	A91RBP.....	260
A46PPGP.....	351	A65P.....	349	A75TC.....	353	A93PB.....	351
A46PS.....	351	A65PB.....	338	A75TC6.....	353	A93PBP.....	351
A47PB.....	352	A65PBP.....	338	A76GB.....	346	A94VB.....	344
A47PBB.....	352	A65PBPBPG.....	338	A77S1B.....	335	A94VBP.....	344
A47PBBP.....	352	A65PBPBPGP.....	338	A77S1BP.....	335	A9R.....	348
A47PBP.....	352	A65PRXB.....	338	A78CB1.....	336	A9RB.....	347
A47PS.....	352	A65PRXB.....	338	A78CB1P.....	336	A9RBP.....	347
A48CB.....	343	A65PS.....	338	A78NCCB.....	336	ACP5B.....	328
A48CBP.....	343	A65TB.....	338	A78NCCBB.....	336	ACP5BP.....	328
A48TC.....	353	A65TBP.....	338	A78RXB.....	336	ACP5S.....	328
A49PB.....	350	A66AB.....	348	A78RXBP.....	336	ACP7B.....	328
A49PBB.....	350	A66ABP.....	348	A79CB.....	344	ACP7BP.....	328
A49PBBP.....	350	A66GB.....	346	A79CBP.....	344	ACP7S.....	328
A49PBP.....	350	A66GBP.....	346	A7TRSSB.....	336	ADH55B.....	357
A4TC4WB.....	353	A66PB.....	338	A7TRSSBP.....	336	AIL21B.....	348
A4TC4WBP.....	353	A66PBP.....	338	A7W6FTB.....	353	AIL21BP.....	348
A52AB.....	347	A66RB.....	348	A7W8FTB.....	353	AL145PWTB.....	352
A52ABP.....	347	A66RBP.....	348	A7WCB.....	353	AL145PWTBP.....	352
A52GB.....	346	A67BB.....	338	A7WCBP.....	353	AL16RB.....	347
A52GBP.....	346	A67BBP.....	338	A80GB.....	335	AL16RBP.....	347
A52RB.....	347	A67CB.....	338	A830B.....	350	AL17RB.....	347
A52RBP.....	347	A67CBP.....	338	A839B.....	350	AL17RBP.....	347
A53GB.....	330	A67CBPG.....	338	A86PB.....	351	AL421PG.....	351
A53GBP.....	330	A67CBPGP.....	338	A86PBP.....	351	AL42PB.....	351
A54GB.....	330	A67P10G.....	338	A8R.....	348	AL42PBP.....	351
A54GBP.....	330	A67P10GP.....	338	A8RB.....	347	AL42PG.....	351
A54GK.....	330	A68AB.....	348	A8RBP.....	347	AL42PGP.....	351
A54GKP.....	330	A68ABP.....	348	A8RK.....	348	AL45PWTB.....	352
A55CB.....	330	A68P.....	349	A90AB.....	348	AL45PWTBP.....	352
A55CBP.....	330	A68P1B.....	338	A90ABP.....	348	AL82AB.....	131
A55GB.....	331	A68PB.....	338	A90CB.....	337	AL82ABP.....	131
A55GBP.....	331	A68PBP.....	338	A90GB.....	346	AL82RB.....	131
A55GK.....	331	A68RB.....	348	A90P1B.....	355	AL82RBP.....	131
A55GKP.....	331	A68RBP.....	348	A90PB.....	355	AL90AB.....	132
A56GB.....	331	A68SSB.....	343	A90RB.....	348	AL90ABP.....	132
A56GBP.....	331	A68SSBP.....	343	A90RBP.....	348	AL90AK.....	132
A57CB.....	332	A69CB.....	343	A91AB.....	260	AL90AS.....	132
A57CBP.....	332	A69CBP.....	343	A91ABP.....	260	AL90RB.....	132
A57CCB.....	353	A69GB.....	346	A91BB.....	337	AL90RBP.....	132
A57CCBP.....	353	A69GBP.....	346	A91BBP.....	337	AL90RCB.....	132
A57GB.....	331	A69NCCB.....	343	A91BOB.....	337	AL90RCBP.....	132
A57GBP.....	331	A69RXC.....	343	A91BOBP.....	337	AL90RK.....	132
A57GK.....	331	A69RXC.....	343	A91BS.....	337	AL90RS.....	132
A57GKP.....	331	A69RXC.....	343	A91CB.....	337	AL91A1224B.....	131
A57WB.....	353	A6TC4WB.....	353	A91CBP.....	337	AL91AB.....	131
A57WBP.....	353	A6TC4WBP.....	353	A91G15B1.....	337	AL91ABP.....	131
A57WH.....	353	A6TC5B.....	353	A91G15B1P.....	337	AL91CAB.....	131
A58GB.....	331	A700.....	355	A91GB.....	337	AL91CABP.....	131
A58GBP.....	331	A70ECBB.....	344	A91GBP.....	337	AL91RB.....	131
A5TRSSB.....	334	A70ECCRB.....	344	A91GOB.....	337	AL91RBP.....	131
A5TRSSBP.....	334	A70GB.....	335	A91GOBP.....	337	AL9RB.....	348
		A70GBD.....	335				

AL9RBP	348	BU33CRXLB	249	BUL12CB1FPG	86	BUL90CB	88
ALEDFB	356	BU33CRXLB	249	BUL12CB1FPGP	86	BUL90CBP	88
ALEDFBP	356	BU41CB	248	BUL12CBP	86	CB11AB	273
ALEDFS	356	BU41CBP	248	BUL12CFB	86	CB11AS	273
ALEDRST1B	355	BU44CB	249	BUL12CFBP	86	CB11AS6	273
ALEDRST1BP	355	BU44CBP	249	BUL12CKB	86	CB11WAB	273
ALEDRST2B	355	BU45CB	249	BUL12CKBP	86	CB11WABP	273
ALEDRST2BP	355	BU45CBP	249	BUL12CSB	86	CB15AK	273
APL1AB	348	BU49CB	249	BUL12CSBP	86	CB20AB	274
APL1ABP	348	BU49CBP	249	BUL13CB	179	CB20ABP	274
APL1CB	348	BU64CB	249	BUL13CBP	179	CB20AS	274
APL1CBP	348	BU64CBP	249	BUL22CB	85	CB22AB	274
APL5AB	348	BU70CB	249	BUL22CBP	85	CB22ABP	274
APL5ABP	348	BU70CBP	249	BUL23C24B	82	CB22AS	274
APL5CB	348	BU74CB	249	BUL23C24BP	82	CB22RB	274
APL5CBP	348	BU74CBP	249	BUL23CB	82	CB22RBP	274
APLL11AB	348	BUL002CB	87	BUL23CBP	82	CBL22AB	160
APLL11CB	348	BUL002CBP	87	BUL24CB	88	CBL22ABP	160
ARVIL35B	348	BUL002CM3B	87	BUL24CBP	88	CBL22AS	160
ARVIL35BP	348	BUL002CM3BP	87	BUL28CLPB	181	CBL22CAB	160
AST60B	348	BUL003C1224B	81	BUL28CLPBP	181	CBL22CABP	160
AST60BP	348	BUL003C1224BP	81	BUL35CB	88	CBL22RB	160
AST61B	348	BUL003CB	81	BUL35CBP	88	CBL22RBP	160
AST61BP	348	BUL003CBP	81	BUL43CB	179	DH55	357
BA44FNL	267	BUL003CKB	81	BUL43CBK	179	DH55P	357
BA44FNLP	267	BUL003CKBP	81	BUL43CBKP	179	DL16CC	293
BA44FNR	267	BUL06C1224B	80	BUL43CBP	179	DL16WC	293
BA44FNRP	267	BUL06C1224BP	80	BUL52CB	85	DL55CS	293
BA65ARLB	258	BUL06CB	80	BUL52CBP	85	DLL50CB	222
BA65ARLBP	258	BUL06CBP	80	BUL53CB	82	DLL50CBP	222
BA65ARRB	258	BUL06CFB	80	BUL53CBP	82	DLL50CC	222
BA65ARRBP	258	BUL06CFBP	80	BUL602CB	83	FTL42A1224B	14
BK20BB	345	BUL06CFMB	80	BUL602CBP	83	FTL42A1224BP	14
BK20BBP	345	BUL06CFMBP	80	BUL602CRB	83	FTL53ALCPG	14
BK21BB	350	BUL06CK1MB	80	BUL602CRBP	83	FTL53ALCPGP	14
BK31BB	340	BUL06CK1MBP	80	BUL603CB	77	HLL70HLB	2
BK31BBP	340	BUL06CKB	80	BUL603CBP	77	HLL70HLBP	2
BK42CB	344	BUL06CKBP	80	BUL603CRB	77	HLL70HLS	2
BK42CBP	344	BUL06CMB	80	BUL603CRBP	77	HLL78LB	4
BK45BB	333	BUL06CMBP	80	BUL69CB	180	HLL78LBP	4
BK45BBP	333	BUL101CB	78	BUL69CBMVCV2B	180	HLL78LS	4
BK53BB	330	BUL101CBP	78	BUL69CBMVCV2BP	180	HLL79HB	4
BK53BBP	330	BUL101CKB	78	BUL69CBP	180	HLL79HBP	4
BK5557GB	330	BUL101CKBP	78	BUL69CPG	180	HLL79HS	4
BK5557GBP	330	BUL10CB	85	BUL69CPGP	180	HLL88LB	5
BK55BB	332	BUL10CBP	85	BUL72CB	180	HLL88LBP	5
BK55BBP	332	BUL111CB	84	BUL72CBGK	180	HLL89HB	5
BK57BB	332	BUL111CBP	84	BUL72CBGKP	180	HLL89HBP	5
BK57BBP	332	BUL11CB	79	BUL72CBP	180	HLL90HLB	5
BK66D1B	344	BUL11CBP	79	BUL73CB	181	HLL90HLBP	5
BK66D1BP	344	BUL11CBX	79	BUL73CBP	181	HLL93HLB	3
BK66DB	344	BUL11CBXP	79	BUL74CBK	180	HLL93HLBP	3
BK66DBP	344	BUL11CKB	79	BUL74CBKP	180	HLL93HLS	3
BK70B	335	BUL11CKBP	79	BUL78C3MB	181	IL21CB	289
BK70BB	335	BUL11CM24B	79	BUL78C3MBP	181	IL21CBP	289
BK70BBP	335	BUL11CM24BP	79	BUL78CB	181	IL21CPG	289
BU11CS	248	BUL11CMB	79	BUL78CBP	181	IL21CS	289
BU33CB	249	BUL11CMBP	79	BUL78CEZB	181	IL21CS6	289
BU33CBP	249	BUL12C1224B	86	BUL78CEZBP	181	IL31CS	289
BU33CRX24LB	249	BUL12C1224BP	86	BUL90C24B	88	IL61CB	290
BU33CRX24LBP	249	BUL12CB	86	BUL90C24BP	88	IL61CBP	290

INDEX

IL91CB	290	ILL45CB	191	LP20SB	340	LPL12CB	171
IL91CBP	290	ILL45CBP	191	LP20SBP	340	LPL12CBP	171
ILL01RB	182	ILL46CB	192	LP21CB	278	LPL12CKF2B	171
ILL01RBP	182	ILL46CBP	192	LP21CBP	278	LPL12CKF2BP	171
ILL06COB	182	ILL48CB	192	LP21CS	278	LPL12CKM2B	171
ILL06COBP	182	ILL70ABBAWN	194	LP21CS6	278	LPL12CKM2BP	171
ILL07COB	182	ILL70ABBAWN	194	LP25SB	339	LPL12CKMB	171
ILL07COBP	182	ILL70C24B	193	LP25SBP	339	LPL12CKMBP	171
ILL08COB	183	ILL70C24BP	193	LP25SGGB	339	LPL12CPGB	171
ILL08COBP	183	ILL70CB	193	LP26SKB	285	LPL12CPGBP	171
ILL08COPG	183	ILL70CBAWN	194	LP26SKBP	285	LPL21CB	172
ILL08COPGP	183	ILL70CBAWNFS	194	LP31CB	279	LPL21CBP	172
ILL10CCB	183	ILL70CBAWN	194	LP31CBP	279	LPL26SKB	178
ILL10CCBP	183	ILL70CBAWN	194	LP31CPG	279	LPL26SKBP	178
ILL11CCB	184	ILL70CBBAWN	194	LP31CPGP	279	LPL31C1PG	172
ILL11CCBP	184	ILL70CBBAWN	194	LP31CS	279	LPL31CB	172
ILL124CPG	186	ILL70CBP	193	LP31CS	279	LPL31CBP	172
ILL124CPGP	186	ILL70CBSAWN	194	LP31SB	340	LPL31CEZB	172
ILL21CB	185	ILL70CBSAWN	194	LP31SBP	340	LPL31CEZBP	172
ILL21CBP	185	ILL70CCSAWN	194	LP35BB	340	LPL31CPG	172
ILL21CTPB	185	ILL70CCSAWN	194	LP35BBP	340	LPL31CPGP	172
ILL22C1224B	185	ILL70CCSAWN	194	LP41CB	280	LPL31CPG	172
ILL22C1224BP	185	ILL70CSB	193	LP41CBP	280	LPL31CS	172
ILL22CB	185	ILL70CSBP	193	LP41CS	280	LPL31CSB	172
ILL22CBB	185	ILL71C1BAWN	194	LP41CS6	280	LPL31CSBP	172
ILL22CBBP	185	ILL71CB	193	LP51CB	280	LPL41CB	173
ILL22CBP	185	ILL71CBAWN	194	LP51CBP	280	LPL41CBP	173
ILL22CFS	185	ILL71CBAWNFS	194	LP52CB	281	LPL42CBF	173
ILL22CHB	185	ILL71CBAWN	194	LP52CBP	281	LPL42CBFP	173
ILL22CHBP	185	ILL71CBANP	194	LP52HP	350	LPL43CB	173
ILL24CB	186	ILL71CBP	193	LP52HPP	350	LPL43CBP	173
ILL24CBP	186	ILL71CPG	193	LP54CB	281	LPL43CGBF	173
ILL24CPG	186	ILL71CPGP	193	LP54CBP	281	LPL43CGBFP	173
ILL28CMB	183	ILL71CSB	193	LP55CB	281	LPL55CB	173
ILL28CMBP	183	ILL71CSBP	193	LP55CBP	281	LPL55CBP	173
ILL28CMPG	183	ILL72CB	193	LP56CB	282	LPL55CKB	173
ILL28CMPGP	183	ILL72CBP	193	LP56CBP	282	LPL55CKBP	173
ILL29CB	187	ILL85CB	195	LP55SB	340	LPL55CPG	173
ILL29CBP	187	ILL85CBP	195	LP55SBP	340	LPL55CPGP	173
ILL29CFB	187	ILL86BCB	195	LP65CB	282	LPL56CB	173
ILL29CFBP	187	ILL86BCBP	195	LP65CBP	282	LPL56CBP	173
ILL30CBB	188	ILL86CB	195	LP65CS	282	LPL57CB	174
ILL30CBBP	188	ILL86CBP	195	LP71CB	283	LPL57CBP	174
ILL31CB	188	ILL87CB	196	LP71CBP	283	LPL57CKB	174
ILL31CBP	188	ILL87CBP	196	LP71CS	283	LPL57CKBP	174
ILL32CB	188	ILL91CB	196	LP81BB	283	LPL58CB	175
ILL32CBP	188	ILL91CBP	196	LP81BBP	283	LPL58CBP	175
ILL32CPG	188	ILL91CPG	196	LP81BPG	283	LPL59CB	175
ILL33CB	189	ILL91CPGP	196	LP81BPGP	283	LPL59CBP	175
ILL33CBP	189	LM315BB	197	LP81GB	283	LPL61C24B	176
ILL35CB	188	LM315BBP	197	LP91CB	285	LPL61C24BP	176
ILL35CBP	188	LM835CB	197	LP91CBP	285	LPL61C24PG	176
ILL36CB	189	LM835CBP	197	LP91CS	285	LPL65CB	176
ILL36CBP	189	LP10S	340	LP95CBF	284	LPL65CBB	176
ILL36CPG	189	LP10SB	340	LP97CB	284	LPL65CBBP	176
ILL36CPGP	189	LP10SBP	340	LP97CBP	284	LPL65CBP	176
ILL38CMB	190	LP11CB	278	LPB31CPG	279	LPL81CB	177
ILL38CMBP	190	LP11CBP	278	LPB31CPGP	279	LPL81CBP	177
ILL39CB	191	LP11CPG	278	LPL11CB	170	LPL82CB	177
ILL39CBP	191	LP11CPGP	278	LPL11CBP	170	LPL82CBB	177
ILL39RCB	191	LP11CS	278	LPL11CPG	170	LPL91CAB	178
		LP15S	340	LPL11CPGP	170	LPL91CABP	178
		LP15SB	340				
		LP15SBP	340				

LPL91CB.....	178	MC37ABP.....	265	MC56AB.....	256	MC82ABP.....	271
LPL91CBP.....	178	MC38AB.....	265	MC56ABP.....	256	MC82RB.....	271
LPL91CKALPB.....	178	MC38ABP.....	265	MC56RB.....	256	MC82RBP.....	271
LPL91CKALPBP.....	178	MC38RB.....	265	MC56RBP.....	256	MC90AS.....	260
LPL91CPG.....	178	MC38RBP.....	265	MC57AB.....	255	MC90RS.....	260
LPL91CPGP.....	178	MC42AB.....	266	MC57ABP.....	255	MC91AB.....	260
LPL91CS.....	178	MC42ABP.....	266	MC57AS.....	255	MC91ABP.....	260
LPLB31CPG.....	172	MC42AS.....	266	MC57RB.....	255	MC91AS.....	260
MC11AB.....	261	MC42RB.....	266	MC57RBP.....	255	MC91RS.....	260
MC11ABP.....	261	MC42RBP.....	266	MC57RS.....	255	MC92AB.....	260
MC11AK.....	261	MC42RS.....	266	MC58AS.....	268	MC92ABP.....	260
MC11AS.....	261	MC441WB.....	267	MC58RS.....	268	MC92AS.....	260
MC11RB.....	261	MC442WB.....	267	MC61ABKB.....	257	MC92RB.....	260
MC11RBP.....	261	MC44AB.....	267	MC61ABKBP.....	257	MC92RBP.....	260
MC11RS.....	261	MC44AB1.....	267	MC65AB.....	259	MC92RS.....	260
MC21AS.....	262	MC44AB1P.....	267	MC65ABP.....	259	MC93AB.....	275
MC21RS.....	262	MC44ABP.....	267	MC65ARB.....	258	MC93ABP.....	275
MC22AB.....	262	MC44AS.....	267	MC65ARBP.....	258	MC93R2PG.....	275
MC22ABP.....	262	MC44RB.....	267	MC65AS.....	259	MC93R2PGP.....	275
MC22RB.....	262	MC44RB1.....	267	MC65RB.....	259	MC93RB.....	275
MC22RBP.....	262	MC44RB1P.....	267	MC65RBP.....	259	MC93RBP.....	275
MC25AB.....	252	MC44RBP.....	267	MC65RS.....	259	MC93RK.....	275
MC25ABP.....	252	MC44RS.....	267	MC66AB.....	268	MC93RPG.....	275
MC27AB.....	252	MC48AB.....	266	MC66ABP.....	268	MC93RPGP.....	275
MC27ABP.....	252	MC48ABP.....	266	MC66AS.....	268	MC94RB.....	276
MC30AB.....	261	MC48APG.....	266	MC66HAB.....	268	MC94RBP.....	276
MC30ABP.....	261	MC48APGP.....	266	MC66HABP.....	268	MC95AB.....	272
MC31A15B2.....	263	MC48RB.....	266	MC66RB.....	268	MC95ABP.....	272
MC31AB.....	263	MC48RBP.....	266	MC66RBP.....	268	MC95APG.....	272
MC31ABP.....	263	MC48RPG.....	266	MC66RS.....	268	MC95AS.....	272
MC31AS.....	263	MC48RPGP.....	266	MC67AB.....	259	MC95AS.....	272
MC31R15B2.....	263	MC505ABSB.....	254	MC67ABP.....	259	MC95RB.....	272
MC31RB.....	263	MC505ABSBP.....	254	MC67AK.....	259	MC95RBP.....	272
MC31RBP.....	263	MC52AB.....	253	MC67ARB.....	258	MC95RS.....	272
MC31RS.....	263	MC52ABP.....	253	MC67ARBP.....	258	MC97R70PG.....	276
MC32AB.....	263	MC52AXB.....	253	MC67RB.....	259	MC97RB.....	276
MC32ABB.....	263	MC52AXBP.....	253	MC67RBP.....	259	MC97RBP.....	276
MC32ABBP.....	263	MC52RB.....	253	MC67RK.....	259	MC97RK.....	276
MC32ABP.....	263	MC52RBP.....	253	MC68AB.....	269	MC99AB.....	277
MC32ABS.....	263	MC52RXB.....	253	MC68ABP.....	269	MC99ABP.....	277
MC32AS.....	263	MC52RXBP.....	253	MC68AS.....	269	MC99AK.....	277
MC32RB.....	263	MC53AB.....	254	MC68RB.....	269	MC99RB.....	277
MC32RBB.....	263	MC53ABP.....	254	MC68RBP.....	269	MC99RBP.....	277
MC32RBBP.....	263	MC53ABSB.....	254	MC68RS.....	269	MC99RK.....	277
MC32RBP.....	263	MC53ABSBP.....	254	MC70AB.....	269	MCL002AXB.....	130
MC32RBS.....	263	MC53AKB.....	254	MC70ABP.....	269	MCL002RXB.....	130
MC32RS.....	263	MC53AKBP.....	254	MC70AS.....	269	MCL0030ABB.....	144
MC35AB.....	264	MC53AS.....	254	MC70RB.....	269	MCL0030RBB.....	144
MC35ABP.....	264	MC53RB.....	254	MC70RBP.....	269	MCL0032ABB.....	148
MC35AEB.....	264	MC53RBP.....	254	MC70RS.....	269	MCL0032ABBP.....	148
MC35AEBP.....	264	MC53RKB.....	254	MC71AS.....	270	MCL0032ABS.....	148
MC35AS.....	264	MC53RKBP.....	254	MC71RS.....	270	MCL0032RBB.....	148
MC36AB.....	264	MC53RS.....	254	MC76AB.....	270	MCL0032RBBP.....	148
MC36ABP.....	264	MC54AB.....	254	MC76ABP.....	270	MCL0032RBS.....	148
MC36AS.....	264	MC54ABP.....	254	MC77RB.....	275	MCL0039ABB.....	145
MC36AS6.....	264	MC54RB.....	254	MC77RBP.....	275	MCL0039ABBP.....	145
MC36RB.....	264	MC54RBP.....	254	MC81AB.....	271	MCL0039RBB.....	145
MC36RBP.....	264	MC55AB.....	255	MC81ABP.....	271	MCL0039RBBP.....	145
MC36RS.....	264	MC55ABP.....	255	MC81RB.....	271	MCL10AB.....	112
MC36RS6.....	264	MC55RB.....	255	MC81RBP.....	271	MCL10ABP.....	112
MC37AB.....	265	MC55RBP.....	255	MC82AB.....	271	MCL10ACK12JPG.....	112
						MCL10ACK3L12B.....	163

INDEX

MCL10ACKA12B.....	112	MCL111AKPGP.....	110	MCL11RPGP.....	114	MCL13CA2B.....	139
MCL10ACKA12PG.....	112	MCL111RB.....	110	MCL11SAB.....	108	MCL13CA2BP.....	139
MCL10ACKB.....	112	MCL111RBP.....	110	MCL11SABP.....	108	MCL13CA3B.....	139
MCL10ACKPG.....	112	MCL111RKB.....	110	MCL11SACKB.....	108	MCL13CA3BP.....	139
MCL10ACKPGP.....	112	MCL111RKBP.....	110	MCL11SACKBP.....	108	MCL13CR2B.....	139
MCL10AK1224B.....	112	MCL111RKPG.....	110	MCL11SAK1B.....	108	MCL13CR2BP.....	139
MCL10AK1224BP.....	112	MCL111RKPGP.....	110	MCL11SAK1BP.....	108	MCL13R21PG.....	139
MCL10AK12JPG.....	112	MCL112AKB.....	111	MCL11SAKB.....	108	MCL13R2B.....	139
MCL10AK1FPG.....	112	MCL112AKBP.....	111	MCL11SAKBP.....	108	MCL13R2BP.....	139
MCL10AKA10PG.....	112	MCL112RB.....	111	MCL11SRB.....	108	MCL13R2MB.....	139
MCL10AKA12B.....	112	MCL112RBP.....	111	MCL11SRBP.....	108	MCL13R2MBP.....	139
MCL10AKB.....	112	MCL112RKB.....	111	MCL11SRCKB.....	108	MCL13RS.....	139
MCL10AKBP.....	112	MCL112RKBP.....	111	MCL11SRCKBP.....	108	MCL13RTRS.....	139
MCL10AKL12B.....	112	MCL11A24KB.....	114	MCL11SRK1B.....	108	MCL14A12GB.....	140
MCL10AKL12PG.....	112	MCL11AB.....	114	MCL11SRK1BP.....	108	MCL14A12GBP.....	140
MCL10AKL12PGN.....	112	MCL11ABP.....	114	MCL11SRKB.....	108	MCL14AB.....	140
MCL10AKL18JPG.....	112	MCL11AHPG.....	114	MCL11SRKBP.....	108	MCL14ABF.....	140
MCL10CAK14B.....	112	MCL11AHPGP.....	114	MCL121AK9PVG.....	110	MCL14ABFP.....	140
MCL10CAK14BP.....	112	MCL11AK12B.....	114	MCL121AK9PVG.....	110	MCL14ABP.....	140
MCL10CRK14B.....	113	MCL11AK12PG.....	114	MCL121RK9PVG.....	110	MCL14AGB.....	140
MCL10CRK14BP.....	113	MCL11AKAB.....	114	MCL121RK9PVG.....	110	MCL14AGBP.....	140
MCL10RB.....	113	MCL11AKABP.....	114	MCL12AB.....	115	MCL14AGPB.....	140
MCL10RBP.....	113	MCL11AKB.....	114	MCL12ABP.....	115	MCL14AGPBP.....	140
MCL10RCK12JPG.....	113	MCL11AKBF.....	114	MCL12AK.....	115	MCL14CABF.....	140
MCL10RCK3L12B.....	163	MCL11AKBFP.....	114	MCL12AKB.....	115	MCL14CABFP.....	140
MCL10RCKA12B.....	113	MCL11AKBP.....	114	MCL12AKBP.....	115	MCL14CAGB.....	140
MCL10RCKA12PG.....	113	MCL11AKPRB.....	114	MCL12AKPG.....	115	MCL14CRBF.....	140
MCL10RCKB.....	113	MCL11AKPVB.....	114	MCL12ARLB.....	116	MCL14CRBFP.....	140
MCL10RCKPG.....	113	MCL11AKPVG.....	114	MCL12ARLBP.....	116	MCL14CRGB.....	140
MCL10RCKPGP.....	113	MCL11APG.....	114	MCL12ARRB.....	116	MCL14R2B.....	140
MCL10RK1224B.....	113	MCL11APGP.....	114	MCL12ARRBP.....	116	MCL14R2BP.....	140
MCL10RK1224BP.....	113	MCL11CAB.....	114	MCL12CA2RLB.....	116	MCL14RB.....	140
MCL10RK12JPG.....	113	MCL11CABP.....	114	MCL12CA2RRB.....	116	MCL14RBF.....	140
MCL10RK1FPG.....	113	MCL11CAKB.....	114	MCL12RB.....	115	MCL14RBF.....	140
MCL10RKA10PG.....	113	MCL11CAKBF.....	114	MCL12RBP.....	115	MCL14RBP.....	140
MCL10RKA12B.....	113	MCL11CAKBP.....	114	MCL12RK.....	115	MCL14RGB.....	140
MCL10RKB.....	113	MCL11CAKPG.....	114	MCL12RK3B.....	164	MCL14RGBP.....	140
MCL10RKB.....	113	MCL11CAKPGP.....	114	MCL12RK3BP.....	164	MCL14RPG.....	140
MCL10RKDTPG.....	113	MCL11CRB.....	114	MCL12RK3RMB.....	164	MCL14RPGP.....	140
MCL10RKDTPGP.....	113	MCL11CRBP.....	114	MCL12RKB.....	115	MCL155AB.....	118
MCL10RKL12B.....	113	MCL11CRKB.....	114	MCL12RKBP.....	115	MCL155ABP.....	118
MCL10RKL12PG.....	113	MCL11CRKBF.....	114	MCL12RKPG.....	115	MCL155RB.....	118
MCL10RKL12PGN.....	113	MCL11CRKBP.....	114	MCL131A210B.....	139	MCL155RBP.....	118
MCL10RKL18JPG.....	113	MCL11CRKPG.....	114	MCL131A2B.....	139	MCL157AB.....	125
MCL110AB.....	109	MCL11CRKPGP.....	114	MCL131A2BP.....	139	MCL157ABP.....	125
MCL110ABP.....	109	MCL11R24KB.....	114	MCL131AC210B.....	139	MCL157RB.....	125
MCL110AKB.....	109	MCL11RB.....	114	MCL131CA3B.....	139	MCL157RBP.....	125
MCL110AKBF.....	109	MCL11RBP.....	114	MCL131CR3B.....	139	MCL15AKPG.....	141
MCL110AKBFP.....	109	MCL11RHPG.....	114	MCL131R210B.....	139	MCL15AKPGP.....	141
MCL110AKBP.....	109	MCL11RHPPG.....	114	MCL131R2B.....	139	MCL15APG.....	141
MCL110RB.....	109	MCL11RK12B.....	114	MCL131R2BP.....	139	MCL15APGP.....	141
MCL110RBP.....	109	MCL11RK12PG.....	114	MCL131RC210B.....	139	MCL15RPG.....	141
MCL110RKB.....	109	MCL11RKAB.....	114	MCL13A21PG.....	139	MCL15RPGP.....	141
MCL110RKB.....	109	MCL11RKB.....	114	MCL13A2B.....	139	MCL15RPG.....	141
MCL110RKBFP.....	109	MCL11RKB.....	114	MCL13A2BP.....	139	MCL15RPGP.....	141
MCL110RKBFP.....	109	MCL11RKBFP.....	114	MCL13A2MB.....	139	MCL165AB.....	133
MCL110RKBFP.....	109	MCL11RKBFP.....	114	MCL13A2MBP.....	139	MCL165ABP.....	133
MCL110RKBFP.....	109	MCL11RKBFP.....	114	MCL13APG.....	139	MCL165RB.....	133
MCL110RKBFP.....	109	MCL11RKBFP.....	114	MCL13APGP.....	139	MCL165RBP.....	133
MCL111AB.....	110	MCL11RKBFP.....	114	MCL13AS.....	139	MCL17AB.....	143
MCL111ABP.....	110	MCL11RKP4G.....	114	MCL13ATRS.....	139	MCL17ABB.....	143
MCL111AKB.....	110	MCL11RKPVG.....	114				
MCL111AKBP.....	110	MCL11RKPVG.....	114				
MCL111AKPG.....	110	MCL11RPG.....	114				

MCL17ABP.....	143	MCL32RS.....	147	MCL527AMB.....	127	MCL57ACB.....	126
MCL17CAB.....	143	MCL35A32G.....	149	MCL527AS.....	127	MCL57ACBP.....	126
MCL17CABP.....	143	MCL35A32GP.....	149	MCL527RB.....	127	MCL57AK.....	126
MCL17CRB.....	143	MCL35AEB.....	149	MCL527RBP.....	127	MCL57R1224B.....	126
MCL17CRBP.....	143	MCL35AEBP.....	149	MCL527RFB.....	127	MCL57R1224BP.....	126
MCL17RB.....	143	MCL36AB.....	150	MCL527RFBP.....	127	MCL57RB.....	126
MCL17RBB.....	143	MCL36ABP.....	150	MCL527RK.....	127	MCL57RBP.....	126
MCL17RBP.....	143	MCL36AS.....	150	MCL527RK6.....	127	MCL57RCB.....	126
MCL180ARB.....	161	MCL36AS6.....	150	MCL527RMB.....	127	MCL57RCBP.....	126
MCL180ARB.....	161	MCL36RB.....	150	MCL527RS.....	127	MCL57RK.....	126
MCL180ARFK.....	161	MCL36RBP.....	150	MCL52AB.....	124	MCL57RKB.....	126
MCL181ARCRB.....	162	MCL40AB.....	151	MCL52ABP.....	124	MCL57RKBP.....	126
MCL181ARCRGB.....	162	MCL40ABP.....	151	MCL52AHXB.....	122	MCL58AB.....	128
MCL181ARCRL12B.....	162	MCL40APB.....	151	MCL52AHXBP.....	122	MCL58ABP.....	128
MCL19AB.....	143	MCL40APBP.....	151	MCL52AMB.....	124	MCL58ACB.....	128
MCL19ABP.....	143	MCL40AS.....	151	MCL52AMB.....	124	MCL58ACBP.....	128
MCL19CAB.....	143	MCL40RB.....	151	MCL52AMB.....	124	MCL58ACBP.....	128
MCL19CABP.....	143	MCL40RBP.....	151	MCL52RB.....	124	MCL58AMFB.....	128
MCL19CRB.....	143	MCL40RS.....	151	MCL52RBP.....	124	MCL58AMFBP.....	128
MCL19CRBP.....	143	MCL44AB.....	151	MCL52RMB.....	124	MCL58APMB.....	128
MCL19RB.....	143	MCL44AB1.....	151	MCL52RMBP.....	124	MCL58RB.....	128
MCL19RBP.....	143	MCL44AB1P.....	151	MCL54AB.....	124	MCL58RBP.....	128
MCL21AB.....	117	MCL44ABP.....	151	MCL54ABP.....	124	MCL58RMFB.....	128
MCL21ABP.....	117	MCL44RB.....	151	MCL54RB.....	124	MCL58RMFBP.....	128
MCL21AKRGVB.....	114	MCL44RB1.....	151	MCL54RBP.....	124	MCL58RPMB.....	128
MCL21AKRYVB.....	114	MCL44RB1P.....	151	MCL55A1224B.....	119	MCL59A1224B.....	129
MCL21RB.....	117	MCL44RBP.....	151	MCL55A1224BP.....	119	MCL59A1224BP.....	129
MCL21RBP.....	117	MCL45AB.....	152	MCL55AB.....	119	MCL59AB.....	129
MCL21RKPV4G.....	114	MCL45ABP.....	152	MCL55ABP.....	119	MCL59ABP.....	129
MCL21RKPVG.....	114	MCL45AS.....	152	MCL55ACB.....	119	MCL59R1224B.....	129
MCL22RK3B.....	164	MCL45RB.....	152	MCL55ACBP.....	119	MCL59R1224BP.....	129
MCL22RK4B.....	164	MCL45RBP.....	152	MCL55AK.....	119	MCL59RB.....	129
MCL22RK5B.....	164	MCL45RS.....	152	MCL55FRB.....	119	MCL59RBP.....	129
MCL23AB.....	117	MCL46AB.....	152	MCL55FRBP.....	119	MCL61AB.....	135
MCL23ABP.....	117	MCL46ABP.....	152	MCL55R1224B.....	119	MCL61ABP.....	135
MCL23RB.....	117	MCL46RB.....	152	MCL55R1224BP.....	119	MCL61AK.....	135
MCL23RBP.....	117	MCL46RBP.....	152	MCL55RB.....	119	MCL61AR26BK.....	137
MCL290APG.....	142	MCL48AB.....	154	MCL55RBP.....	119	MCL61AR26BKP.....	137
MCL290RPG.....	142	MCL48ABP.....	154	MCL55RCB.....	119	MCL61ARB.....	137
MCL299AB.....	142	MCL48ABP.....	154	MCL55RCBP.....	119	MCL61ARBP.....	137
MCL299ABP.....	142	MCL48AKB.....	154	MCL55RK.....	119	MCL61AS.....	135
MCL299RB.....	142	MCL48AKBP.....	154	MCL56AB.....	121	MCL61RB.....	135
MCL299RBP.....	142	MCL48CAB.....	154	MCL56ABP.....	121	MCL61RBP.....	135
MCL31AB.....	146	MCL48CABP.....	154	MCL56AFB.....	121	MCL61RK.....	135
MCL31ABP.....	146	MCL49AB.....	153	MCL56AFBP.....	121	MCL61RS.....	135
MCL31RB.....	146	MCL49ABP.....	153	MCL56AFMB.....	121	MCL63AB.....	136
MCL31RBP.....	146	MCL49RB.....	153	MCL56AK.....	121	MCL63ABP.....	136
MCL31RBP.....	146	MCL49RBP.....	153	MCL56AK6.....	121	MCL63CAB.....	136
MCL31RPG.....	146	MCL505ABSB.....	120	MCL56AS.....	121	MCL63CABP.....	136
MCL32AB.....	147	MCL505ABSBP.....	120	MCL56RB.....	121	MCL63CRB.....	136
MCL32ABB.....	147	MCL505GABSB.....	120	MCL56RBP.....	121	MCL63CRBP.....	136
MCL32ABB.....	147	MCL505GABSBP.....	120	MCL56RFB.....	121	MCL63RB.....	136
MCL32ABP.....	147	MCL50AB.....	123	MCL56RFBP.....	121	MCL63RBP.....	136
MCL32ABP.....	147	MCL50ABP.....	123	MCL56RFMB.....	121	MCL65A24B.....	134
MCL32ABS.....	147	MCL50RB.....	123	MCL56RK.....	121	MCL65A24BP.....	134
MCL32AS.....	147	MCL50RB.....	123	MCL56RK6.....	121	MCL65AB.....	134
MCL32ATB.....	147	MCL50RBP.....	123	MCL56RMB.....	121	MCL65ABP.....	134
MCL32ATBP.....	147	MCL527AB.....	127	MCL56RS.....	121	MCL65AKB.....	134
MCL32RB.....	147	MCL527ABP.....	127	MCL57A24B.....	126	MCL65ARB.....	137
MCL32RBB.....	147	MCL527AFB.....	127	MCL57A24BP.....	126	MCL65ARBP.....	137
MCL32RBBP.....	147	MCL527AFBP.....	127	MCL57AB.....	126	MCL65CAB.....	134
MCL32RBP.....	147	MCL527AK.....	127	MCL57ABP.....	126	MCL65CABP.....	134
MCL32RBP.....	147	MCL527AK6.....	127				

INDEX

MCL65CARB.....	137	MCL78RB	166	MCL98RBTKPG	165	RE31RS	324
MCL65CARBP.....	137	MCL78RBP	166	MCL98RK	165	RE35AB.....	324
MCL65CRB	134	MCL81AB.....	158	MCL98RL601B.....	165	RE35ABP.....	324
MCL65CRBP	134	MCL81ABP.....	158	MCL98RL60B.....	165	RE35RB	324
MCL65R24B	134	MCL81RB	158	MCL99AB.....	138	RE35RBP	324
MCL65R24BP	134	MCL81RBP	158	MCL99ABP.....	138	RE37AB.....	324
MCL65RB	134	MCL82AB.....	157	MCL99AC1B.....	138	RE37ABP.....	324
MCL65RBP	134	MCL82RB	157	MCL99AC1BP.....	138	RE37RB	324
MCL65RKB	134	MCL83RB	167	MCL99RB	138	RE37RBP	324
MCL66A24B.....	155	MCL83RBP	167	MCL99RBP	138	RE418T.....	326
MCL66A24BP.....	155	MCL83RK	167	MCL99RC1B	138	RE52AB.....	323
MCL66AB.....	155	MCL84RB	169	MCL99RC1BP	138	RE52ARK	323
MCL66ABP.....	155	MCL84RBP	169	QH16CTS.....	291	RE52RB	323
MCL66APG.....	155	MCL85AB.....	158	QH16CTSP.....	291	RT10A1B	325
MCL66APGP.....	155	MCL85ABP.....	158	QH36CTS.....	291	RT10AB	325
MCL66AS	155	MCL85AS	158	QH36CTSP.....	291	RT10R1B.....	325
MCL66CAB.....	155	MCL85RS.....	158	RB10A.....	292	RT10RB.....	325
MCL66CABP.....	155	MCL86AB.....	159	RBL10AS	93	RT150W12B	326
MCL66CRB	155	MCL86ABP.....	159	RBL10CA.....	92	RT150W12BP	326
MCL66CRBP	155	MCL86RB	159	RBL10CC.....	92	RT150WBD.....	326
MCL66R24B	155	MCL86RBP	159	RBL13AB.....	94	RT150WBDP	326
MCL66R24BP	155	MCL88RCB	166	RBL14AB.....	94	RT150Y1B.....	327
MCL66RB	155	MCL88RCBP	166	RC	320	RT150Y1BP	327
MCL66RBP	155	MCL90AS	131	RCP	320	RT150Y1DB.....	327
MCL66RPG	155	MCL90RS.....	131	RE10018T.....	326	RT150Y1DBP.....	327
MCL66RPGP.....	155	MCL914R1PG	168	RE10AB.....	323	RT150Y2B.....	327
MCL66RS.....	155	MCL91AB.....	131	RE10ABP.....	323	RT150Y2BP	327
MCL67AB.....	134	MCL91ABP.....	131	RE10AK.....	323	RT150Y2DB.....	327
MCL67ABP.....	134	MCL91AK.....	131	RE10ARFK.....	323	RT150Y2DBP.....	327
MCL67ARB.....	137	MCL91RB	131	RE10RB	323	RT21AB	325
MCL67ARBP.....	137	MCL91RBP	131	RE10RBP	323	RT21RB.....	325
MCL67RB	134	MCL91RK	131	RE10RK	323	RTR0315066CB.....	326
MCL67RBP	134	MCL922RB	164	RE11AB.....	323	RTR03150711CB.....	326
MCL70RB	166	MCL922RBP	164	RE11ABP.....	323	RTR03150711CBP	326
MCL70RBF2.....	166	MCL93RB	168	RE11RB	323	RTR1015066CB.....	326
MCL70RBF2P	166	MCL93RBP	168	RE11RBP	323	RTR10150711CB.....	326
MCL70RBP	166	MCL93RK	168	RE12AK.....	323	RTR10150WB	326
MCL70RCB	166	MCL93RPG	168	RE12ARK	323	RTR10150WBP	326
MCL70RCBP	166	MCL93RPGP	168	RE12RK	323	RTR15066B.....	326
MCL70RCGB	166	MCL95AB.....	159	RE13AB.....	324	RTR15066BP	326
MCL70RS.....	166	MCL95ABF.....	159	RE13ABP.....	324	RTR15066PB	326
MCL71RB	156	MCL95ABFP.....	159	RE13RB	324	RTR15066PBP	326
MCL71RBP	156	MCL95ABP.....	159	RE13RBP	324	RTR150711B.....	326
MCL73AB.....	154	MCL95AS	159	RE15AB.....	323	RTR150711BP	326
MCL73ABP.....	154	MCL95RB	159	RE15ABP.....	323	RTR150711PB	326
MCL73RB	154	MCL95RBF.....	159	RE15AK.....	323	RTR150711PBP	326
MCL73RBP	154	MCL95RBF	159	RE15ARK	323	RTRE150GB	327
MCL75AB.....	134	MCL95RBP	159	RE15RB	323	RTRE150GBP	327
MCL75ABP.....	134	MCL95RS.....	159	RE15RBP	323	RTRE150OB	327
MCL75RB	134	MCL964RB	167	RE15RK	323	RTRE150OBP	327
MCL75RBP	134	MCL96AB.....	131	RE18T.....	326	RTRE150RB	327
MCL76AB.....	156	MCL96ABP.....	131	RE2018T.....	326	RTRE150RBP	327
MCL76ABP.....	156	MCL96RB	131	RE21AB.....	324	RV60BBK.....	320
MCL76AS	156	MCL96RBP	131	RE21ABP.....	324	RV60BBKP	320
MCL76RB	156	MCL97RB	169	RE21ARK	324	RV60BK.....	320
MCL76RBP	156	MCL97RBP	169	RE21AS.....	324	RV60BKP	320
MCL76RS.....	156	MCL97RK	169	RE21RB	324	RVCST90BL.....	299
MCL77AB.....	134	MCL97RPG	169	RE21RBP	324	RVCST90BR	299
MCL77ABP.....	134	MCL97RPGP	169	RE21RS	324	RVIL21	308
MCL77RB	134	MCL98RB	165	RE21T.....	326	RVIL21P	308
MCL77RBP	134	MCL98RBP	165	RE31AS.....	324	RVIL21S.....	308

RVIL22	308	RVST61S	298	SLL72AB2	90	ST45RBP	230
RVIL22P	308	RVSTB60	298	SLL72AB2P	90	ST45RGB	230
RVIL22S	308	RVSTB60P	298	SLL72AKB1	90	ST45RGBP	230
RVIL35	307	RVSTB61	298	SLL72AKB1P	90	ST45RK	230
RVIL35P	307	RVSTB61P	298	SLL72AKB2	90	ST45RS	230
RVILL33	306	RVSTL0060	297	SLL72AKB2P	90	ST46RB	230
RVILL33FS	306	RVSTL0060P	297	SLL81ACB	100	ST46RBP	230
RVILL33P	306	RVSTL0060RFK	297	SLL81ACBP	100	ST47RB	231
RVILL33PB	306	RVSTL0061	297	SLL81CB	100	ST47RBP	231
RVILL34	306	RVSTL0061P	297	SLL81CBP	100	ST47RKB	231
RVILL34FS	306	RVSTL10	294	SLL93AB	91	ST47RKBP	231
RVILL34P	306	RVSTL10K	294	SLL93ABP	91	ST4RB	242
RVILL39	304	RVSTL10P	294	SLL93RB	91	ST4RBP	242
RVILL39P	304	RVSTL11	294	SLL93RBP	91	ST4RS	242
RVILL40	305	RVSTL11P	294	ST16RB	243	ST51RB	237
RVILL40FS	305	RVSTL20	295	ST16RBP	243	ST51RBP	237
RVILL40P	305	RVSTL20K	295	ST16RS	243	ST51RS	237
RVPL1A	301	RVSTL20P	295	ST17RB	243	ST52AA	237
RVPL1AP	301	RVSTL21	295	ST17RBP	243	ST52AAP	237
RVPL1C	301	RVSTL21P	295	ST17RS	243	ST52RA	237
RVPL1CP	301	RVSTL60	296	ST20RS	238	ST52RB	237
RVPL3A	301	RVSTL60P	296	ST21RS	238	ST52RBP	237
RVPL3AP	301	RVSTL60S	296	ST24RB	238	ST53AAB	237
RVPL3C	301	RVSTL61	296	ST24RBP	238	ST53AABP	237
RVPL3CFS	301	RVSTL61P	296	ST25RB	238	ST56RS	245
RVPL3CP	301	RVSTL61S	296	ST25RBP	238	ST57RS	245
RVPL5A	302	RVSTLB0060	297	ST26RPG	243	ST5RB	242
RVPL5AB	302	RVSTLB0060P	297	ST26RPGP	243	ST5RBP	242
RVPL5ABP	302	RVSTLB0061	297	ST27RPG	243	ST5RS	242
RVPL5AFS	302	RVSTLB0061P	297	ST27RPGP	243	ST60RB	246
RVPL5AP	302	RVSTLB60	296	ST2RB	241	ST60RBP	246
RVPL5CB	302	RVSTLB60FS	296	ST2RBP	241	ST60RS	246
RVPL5CBP	302	RVSTLB60P	296	ST2RHB	241	ST64RB	232
RVPL7A	302	RVSTLB61	296	ST31RS	246	ST64RBP	232
RVPL7AB	302	RVSTLB61FS	296	ST33AB	233	ST65RB	232
RVPL7ABP	302	RVSTLB61P	296	ST33ABP	233	ST65RBP	232
RVPL7AP	302	SLL15AC1B	95	ST33RB	233	ST6RB	240
RVPL7C	302	SLL15ACC2B	95	ST33RBP	233	ST6RBP	240
RVPL7CB	302	SLL15ARC3B	95	ST34RB	233	ST6RPG	240
RVPL7CBFS	302	SLL15C1B	95	ST34RBP	233	ST6RPGP	240
RVPL7CBP	302	SLL16C1B	96	ST36RPG	244	ST6RS	240
RVPL7CFS	302	SLL17AC1B	97	ST36RPGP	244	ST70AB	232
RVPL7CP	302	SLL17ACC2B	97	ST36RS	244	ST70ABP	232
RVPLL11AB	300	SLL17ARC3B	97	ST37RPG	244	ST70AS	232
RVPLL11ABP	300	SLL17C1B	97	ST37RPGP	244	ST70RB	232
RVPLL11AFS	300	SLL22ACB	98	ST37RS	244	ST70RBP	232
RVPLL11CB	300	SLL22ACBP	98	ST3RB	241	ST70RBTk	232
RVPLL11CFS	300	SLL43AB1	89	ST3RBP	241	ST70RBTkP	232
RVPLL13AB	300	SLL43AB1P	89	ST3RHB	241	ST70RK	232
RVPLL13CB	300	SLL43AB2	89	ST40RB	234	ST70RS	232
RVPLL13CBP	300	SLL43AB2P	89	ST40RBP	234	ST74AB	232
RVPLL13CWB	300	SLL43AKB1	89	ST40RS	234	ST74ABP	232
RVSL21	303	SLL43AKB1P	89	ST42RB	234	ST74RB	232
RVSL21P	303	SLL43AKB2	89	ST42RBP	234	ST74RBP	232
RVSL31	303	SLL43AKB2P	89	ST44AB	230	ST75AB	232
RVSL31P	303	SLL51ACB	99	ST44ABP	230	ST75ABP	232
RVST60	298	SLL51ACBP	99	ST44RB	230	ST75AS	232
RVST60P	298	SLL51CB	99	ST44RBP	230	ST77AB	232
RVST60S	298	SLL51CBP	99	ST45AB	230	ST77ABP	232
RVST61	298	SLL72AB1	90	ST45ABP	230	ST7RB	240
RVST61P	298	SLL72AB1P	90	ST45RB	230	ST7RBP	240

INDEX

ST7RPG.....	240	STL008RPG.....	65	STL116RBP.....	67	STL14RB.....	70
ST7RPGP.....	240	STL008RPGP.....	65	STL117RB.....	67	STL14RBP.....	70
ST7RS.....	240	STL008RS.....	65	STL117RBP.....	67	STL153ARDBB.....	54
ST8RB.....	239	STL009RB.....	65	STL1211RCFHFG.....	9	STL153ARDBBP.....	54
ST8RBP.....	239	STL009RBP.....	65	STL1211RCFHFGP.....	9	STL153ARPB.....	54
ST8RHB.....	239	STL009RPG.....	65	STL12AB.....	35	STL153ARPB.....	54
ST8RS.....	239	STL009RPGP.....	65	STL12ABP.....	35	STL15R1B.....	70
ST90AB.....	235	STL009RS.....	65	STL12R1224B.....	35	STL15R1BP.....	70
ST90ABP.....	235	STL101AB.....	16	STL12R1224BP.....	35	STL15RB.....	70
ST90RB.....	235	STL101ABP.....	16	STL12RB.....	35	STL15RBP.....	70
ST90RBP.....	235	STL101ACB.....	16	STL12RBP.....	35	STL161RB.....	58
ST92AB.....	236	STL101ACBP.....	16	STL12RCB.....	35	STL161RBP.....	58
ST92ABP.....	236	STL101R1224B.....	16	STL12RCBP.....	35	STL161RLB.....	58
ST92RB.....	236	STL101R1224BP.....	16	STL12RCKB.....	35	STL161RLBP.....	58
ST92RBP.....	236	STL101RB.....	16	STL12RCKBP.....	35	STL16NTRB.....	69
ST9RB.....	239	STL101RBP.....	16	STL12RK.....	35	STL16NTRBP.....	69
ST9RBP.....	239	STL101RCB.....	16	STL12RK2B.....	35	STL16RB.....	69
ST9RHB.....	239	STL101RCBP.....	16	STL12RK2BP.....	35	STL16RBP.....	69
ST9RS.....	239	STL101RCFB.....	17	STL12RK3B.....	35	STL16RS.....	69
STL0016RB.....	71	STL101RCFBP.....	17	STL12RK3BP.....	35	STL175AMFB.....	41
STL0016RBP.....	71	STL101RCFMB.....	17	STL12RK4B.....	35	STL175AMFBP.....	41
STL0016RP2G.....	71	STL101RCFMBP.....	17	STL12RK4BP.....	35	STL178RB.....	31
STL0016RP2GP.....	71	STL101RCMB.....	16	STL12RKB.....	35	STL178RBP.....	31
STL0016RS.....	71	STL101RCMBP.....	16	STL12RKB.....	35	STL178RCCFPB.....	31
STL0017RB.....	71	STL101RFB.....	17	STL12RLVB.....	35	STL178RCCFPBP.....	31
STL0017RBP.....	71	STL101RFBP.....	17	STL12RLVBP.....	35	STL178RFPB.....	31
STL0017RP2G.....	71	STL101RFMB.....	17	STL12RMB.....	35	STL178RFPBP.....	31
STL0017RP2GP.....	71	STL101RFMBP.....	17	STL12RMBP.....	35	STL178RK1B.....	31
STL0017RS.....	71	STL101RKB.....	16	STL12RS.....	35	STL178RK1BP.....	31
STL002AB.....	38	STL101RKB.....	16	STL13AB.....	21	STL179RB.....	48
STL002ABP.....	38	STL101RKB.....	16	STL13ABP.....	21	STL179RBP.....	48
STL002RB.....	38	STL101RMB.....	16	STL13R1224B.....	21	STL17NTRB.....	69
STL002RBP.....	38	STL101RMBP.....	16	STL13R1224BP.....	21	STL17NTRBP.....	69
STL002RFB.....	38	STL108RB.....	61	STL13RB.....	21	STL17RB.....	69
STL002RFBP.....	38	STL108RBP.....	61	STL13RBP.....	21	STL17RBP.....	69
STL002RK.....	38	STL109RB.....	61	STL13RFB.....	22	STL17RS.....	69
STL002RK2B.....	38	STL109RBP.....	61	STL13RFBP.....	22	STL190AB.....	56
STL002RK2BP.....	38	STL111AB.....	29	STL13RFHXB.....	22	STL190ABP.....	56
STL002RMB.....	38	STL111ABP.....	29	STL13RFHXB.....	22	STL190RB.....	56
STL002RMBP.....	38	STL111ACB.....	29	STL13RFMB.....	22	STL190RBP.....	56
STL002RS.....	38	STL111ACBP.....	29	STL13RFMBP.....	22	STL190RPG.....	56
STL003A1224B.....	24	STL111R1224B.....	29	STL13RFS.....	22	STL190RPGP.....	56
STL003A1224BP.....	24	STL111R1224BP.....	29	STL13RGB.....	21	STL201RFMB.....	6
STL003AB.....	24	STL111RB.....	29	STL13RGBP.....	21	STL201RFMBP.....	6
STL003ABP.....	24	STL111RBP.....	29	STL13RH1B.....	21	STL201XR1224B.....	7
STL003R1224B.....	24	STL111RCB.....	29	STL13RH1BP.....	21	STL201XR1224BP.....	7
STL003R1224BP.....	24	STL111RCBP.....	29	STL13RH3B.....	21	STL201XRB.....	7
STL003RB.....	24	STL111RCFB.....	30	STL13RH3BP.....	21	STL201XRB.....	7
STL003RBP.....	24	STL111RCFBP.....	30	STL13RHBB.....	21	STL201XRB.....	7
STL003RFB.....	24	STL111RCFMB.....	30	STL13RHBBP.....	21	STL201XRFHXB.....	8
STL003RFBP.....	24	STL111RCFMBP.....	30	STL13RK.....	21	STL201XRFHXB.....	8
STL003RFLB.....	24	STL111RCMB.....	29	STL13RKB.....	21	STL211XRB.....	10
STL003RFLBP.....	24	STL111RCMBP.....	29	STL13RKB.....	21	STL211XRB.....	10
STL003RFMB.....	24	STL111RFB.....	30	STL13RLVB.....	21	STL211XRCB.....	10
STL003RFMBP.....	24	STL111RFBP.....	30	STL13RLVBP.....	21	STL211XRCBP.....	10
STL003RK.....	24	STL111RFMB.....	30	STL13RMB.....	21	STL211XRFHB.....	11
STL003RMB.....	24	STL111RFMBP.....	30	STL13RMB10GK.....	21	STL211XRFHBP.....	11
STL003RMBP.....	24	STL111RHB.....	29	STL13RMB10GKP.....	21	STL211XRFHBP.....	11
STL003RS.....	24	STL111RHB.....	29	STL13RMBP.....	21	STL211XRFHBP.....	11
STL008RB.....	65	STL111RMB.....	29	STL13RS.....	21	STL22AB.....	39
STL008RBP.....	65	STL111RMBP.....	29	STL14R1B.....	70	STL22ABP.....	39
		STL116RB.....	67	STL14R1BP.....	70	STL22CCAB.....	39

STL22CCABP.....	39	STL38RB.....	62	STL543RB.....	26	STL69RRXB.....	47
STL22CCRB.....	39	STL38RBP.....	62	STL543RBP.....	26	STL69RRXBP.....	47
STL22CCRBP.....	39	STL39RB.....	62	STL55AB.....	27	STL69RRXBPG.....	47
STL22RB.....	39	STL39RBP.....	62	STL55ABP.....	27	STL69RRXBPGP.....	47
STL22RBH.....	39	STL3RB.....	64	STL55RB.....	27	STL69RRXCS.....	47
STL22RBHP.....	39	STL3RBP.....	64	STL55RBP.....	27	STL69RRXPG.....	47
STL22RBP.....	39	STL3RGB.....	64	STL55RFMB.....	27	STL69RRXPGP.....	47
STL22RCB.....	39	STL3RGBP.....	64	STL55RFMBP.....	27	STL69RS.....	47
STL22RCBP.....	39	STL412RB.....	37	STL55RMB.....	27	STL6RS.....	62
STL23A24B.....	25	STL412RBP.....	37	STL55RMBP.....	27	STL70AB.....	40
STL23A24BP.....	25	STL413RB.....	23	STL56RB.....	74	STL70ABP.....	40
STL23AB.....	25	STL413RBP.....	23	STL56RBP.....	74	STL70RB.....	40
STL23ABP.....	25	STL413RFHXB.....	23	STL572AB.....	40	STL70RBP.....	40
STL23CCRB.....	25	STL413RFHXP.....	23	STL572ABP.....	40	STL71AKMB.....	42
STL23CCRBP.....	25	STL413RMB.....	23	STL572RB.....	40	STL71AKMBP.....	42
STL23R24B.....	25	STL413RMBP.....	23	STL572RBP.....	40	STL71AMB.....	42
STL23R24BP.....	25	STL42AB.....	19	STL57RB.....	74	STL71AMB.....	42
STL23RB.....	25	STL42ABP.....	19	STL57RBP.....	74	STL72AB.....	33
STL23RBP.....	25	STL42AMB.....	19	STL59RB.....	51	STL72ABP.....	33
STL24AB.....	45	STL42AMB.....	19	STL59RBP.....	51	STL72AMB.....	33
STL24ABP.....	45	STL42RBP.....	19	STL59RCB.....	51	STL72AMB.....	33
STL24RB.....	45	STL42RBP.....	19	STL59RCBP.....	51	STL72CAB.....	33
STL24RBP.....	45	STL42RMB.....	19	STL602RB.....	28	STL72CABP.....	33
STL264RB.....	13	STL42RMBP.....	19	STL602RBP.....	28	STL72R1224B.....	33
STL264RBP.....	13	STL42RS.....	19	STL603RB.....	15	STL72R1224BP.....	33
STL264RCB.....	13	STL43A24B.....	18	STL603RBP.....	15	STL72RB.....	33
STL264RCBP.....	13	STL43A24BP.....	18	STL60RB.....	59	STL72RBP.....	33
STL26RB.....	72	STL43AB.....	18	STL60RBP.....	59	STL72RK.....	33
STL26RBP.....	72	STL43ABP.....	18	STL60RLB.....	59	STL72RKB.....	33
STL27RB.....	72	STL43ABX.....	20	STL60RLBP.....	59	STL72RKB.....	33
STL27RBP.....	72	STL43ABXP.....	20	STL616NTRB.....	68	STL72RKB.....	33
STL28RB.....	66	STL43ABXS.....	20	STL616NTRBP.....	68	STL72RMB.....	33
STL28RBP.....	66	STL43AKB.....	18	STL617NTRB.....	68	STL72RMB.....	33
STL29RB.....	66	STL43AKBP.....	18	STL617NTRBP.....	68	STL72RS.....	33
STL29RBP.....	66	STL43R24B.....	18	STL61RB.....	59	STL73RB.....	36
STL2RB.....	64	STL43R24BP.....	18	STL61RBP.....	59	STL73RBP.....	36
STL2RBP.....	64	STL43RB.....	18	STL61RLB.....	59	STL73RCB.....	36
STL2RGB.....	64	STL43RBHX.....	20	STL61RLBP.....	59	STL73RCBP.....	36
STL2RGBP.....	64	STL43RBHXP.....	20	STL63CRB.....	46	STL73REZB.....	36
STL33RB.....	44	STL43RBP.....	18	STL63CRBP.....	46	STL73REZBP.....	36
STL33RBP.....	44	STL43RBX.....	20	STL63RB.....	46	STL73RK.....	36
STL34RB.....	44	STL43RBXP.....	20	STL63RBP.....	46	STL73RKB.....	36
STL34RBP.....	44	STL43RBXS.....	20	STL64RB.....	52	STL73RKB.....	36
STL35AB.....	45	STL43RK.....	18	STL64RBP.....	52	STL74RBK.....	33
STL35ABP.....	45	STL43RKB.....	18	STL64RCB.....	52	STL74RBK.....	33
STL35ACB.....	45	STL43RKB.....	18	STL64RCBP.....	52	STL74RKB.....	33
STL35ACBP.....	45	STL43RKB.....	18	STL68RB.....	12	STL74RKB.....	33
STL35CCRB.....	45	STL43RMB.....	18	STL68RBP.....	12	STL75AB.....	43
STL35CCRBP.....	45	STL43RMBP.....	18	STL68RBP.....	12	STL75ABP.....	43
STL35RB.....	45	STL512RB.....	32	STL68RBP.....	12	STL75ABP.....	43
STL35RBP.....	45	STL512RBP.....	32	STL68RBP.....	12	STL75AMB.....	43
STL36RB.....	73	STL512RCB.....	32	STL69CRPG.....	47	STL75AMB.....	43
STL36RBP.....	73	STL512RCBP.....	32	STL69CRPGP.....	47	STL75AMFB.....	42
STL36RPG.....	73	STL52ARB.....	55	STL69R2PG.....	47	STL75AMFBP.....	42
STL36RPGP.....	73	STL52ARBP.....	55	STL69R2PGP.....	47	STL75AS.....	43
STL36RS.....	73	STL52ARS.....	55	STL69RB.....	47	STL76RB.....	50
STL37RB.....	73	STL53ARDB.....	55	STL69RBP.....	47	STL76RBP.....	50
STL37RBP.....	73	STL53ARDBP.....	55	STL69RCB.....	47	STL78AB.....	34
STL37RPG.....	73	STL53ARPB.....	55	STL69RCBP.....	47	STL78ABP.....	34
STL37RPGP.....	73	STL53ARPBP.....	55	STL69RK.....	47	STL78RB.....	34
STL37RPGP.....	73	STL53RCB.....	18	STL69RPG.....	47	STL78RBP.....	34
STL37RS.....	73	STL53RCBP.....	18	STL69RPGP.....	47	STL78REZB.....	34
						STL78REZBP.....	34

INDEX

STL78RK	34	TL12CS.....	291	TLL54TBP	217	UCL299CPG	209
STL78RLPB	34	TL14RK	240	TLL55FB.....	217	UCL299CPGP	209
STL78RLPBP	34	TL15RK	243	TLL55FBP	217	UCL32CDB	229
STL78RPG	34	TL16RK	243	TLL56FB.....	218	UCL41CB.....	201
STL78RPGP	34	TL21RK	247	TLL56FBP	218	UCL41CBP	201
STL79RB	49	TL22RK	247	TLL56RK	74	UCL50CB.....	202
STL79RBP	49	TL27BK	239	TLL57FB.....	218	UCL50CBP	202
STL79RPG	49	TL29BK	239	TLL57FBP	218	UCL55CB.....	202
STL79RPGP	49	TL35FS.....	292	TLL60FB.....	218	UCL55CBP	202
STL79RS.....	49	TL35TB.....	292	TLL60FBP	218	UCL59CB.....	203
STL7RS.....	62	TL35TS.....	292	TLL64FB.....	219	UCL60CB.....	204
STL80RB	49	TL36RK	244	TLL64FBP	219	UCL60CBP	204
STL80RBP	49	TL46FS.....	292	TLL70FB.....	219	UCL60CBPG	204
STL82RB	60	TL46TS.....	292	TLL70FBP	219	UCL60CSBB.....	204
STL82RBP	60	TL5RK	240	TLL71FB.....	220	UCL60CSBBP.....	204
STL82RCB	33	TL60RK	242	TLL71FBP	220	UCL60CSNB.....	204
STL82RCBP	33	TL8RK	239	TLL72FB.....	220	UCL60CSNB	204
STL83RB	60	TL9RK	240	TLL72FBP	220	UCL60CSWNB.....	204
STL83RBP	60	TLL0016RK	71	TLL73FB.....	221	UCL60CSWNB	204
STL87RCB	53	TLL002RK	38	TLL73FBP	221	UCL65CB.....	205
STL87RCBP	53	TLL008RK	65	TLL80FB.....	222	UCL65CBP	205
STL87RCPG	53	TLL112RK	29	TLL80FBP	222	UCL66GB	205
STL87RCPGP	53	TLL12RK	35	TLL90RK	62	UCL90BCB	206
STL88RC1PG	34	TLL144FSL	213	TLL9RK	62	UCL90CB.....	206
STL88RC1PGP	34	TLL149FB.....	211	UCL07CB.....	197	UCL91BCB	207
STL88RCB	34	TLL149FBP	211	UCL07CBP	197	UCL91BCKB	207
STL88RCBP	34	TLL150FSL	215	UCL09CB.....	198	UCL91CB.....	207
STL88RCBPG	34	TLL152FSL	216	UCL09CBB	198	UCL91CKB	207
STL88RCBPGP	34	TLL160RK	69	UCL09CBBP	198	UCL92BCB	207
STL88RCPG	34	TLL16RK	69	UCL09CBP	198	UCL92BCKB	207
STL88RCPGP	34	TLL170RK	67	UCL09RCB	198	UCL92CB.....	207
STL89RCB	49	TLL190RK	61	UCL09RCBP	198	UCL92CKB	207
STL89RCBP	49	TLL211XRTMK	10	UCL10BCKB	199	UL11BS.....	261
STL8R3B	63	TLL21RK	75	UCL10CK1B	199	UL53CB	287
STL8R3BP	63	TLL25FS.....	222	UCL10CKB	199	UL53CBP	287
STL8RB	63	TLL26RK	72	UCL10CKBP	199	UL56CB	287
STL8RBP	63	TLL28RK	66	UCL11CB.....	200	UL56CBP	287
STL8RGB	63	TLL29RK	66	UCL11CBP	200	UL94CB	286
STL8RGBP	63	TLL30FB.....	212	UCL11CKB	200	UL94CBP	286
STL90A24B.....	57	TLL30FBP.....	212	UCL11CKBP	200	UL97CPG	288
STL90A24BP.....	57	TLL31RK	76	UCL11CKPG	200	UL97CPGP	288
STL90AB.....	57	TLL36RK	73	UCL11CKPGP	200	ULL25CTB	209
STL90ABP.....	57	TLL44FB.....	213	UCL13C2PG	200	ULL25CTBP	209
STL90R24B	57	TLL44FBP	213	UCL13C2PGP	200	ULL25CTVRB.....	209
STL90R24BP	57	TLL45FB.....	213	UCL13CB2B	200	ULL25CTVRBP	209
STL90RB	57	TLL45FBP	213	UCL13CB2BP	200	ULL69APG.....	210
STL90RBP	57	TLL46CFB.....	214	UCL13CPG	200		
STL9R3B	63	TLL46CFBP	214	UCL13CPGP	200		
STL9R3BP	63	TLL46TB	214	UCL160CB.....	204		
STL9RB	63	TLL46TBP	214	UCL160CBP	204		
STL9RBP	63	TLL48FB.....	215	UCL178RFP2B	208		
STL9RGB	63	TLL48FBP	215	UCL178RFP2BP	208		
STL9RGBP	63	TLL50FB.....	215	UCL19CB.....	201		
TL106CS.....	291	TLL50FBP.....	215	UCL19CBP	201		
TL10CB	291	TLL51FB.....	216	UCL20CB.....	223		
TL10CBP	291	TLL51FBP	216	UCL21CB.....	224		
TL10CS.....	291	TLL51FRPG	216	UCL22CB.....	225		
TL10SS.....	291	TLL52FB.....	216	UCL23CB.....	226		
TL11CPG	291	TLL52FBP	216	UCL24CB.....	227		
TL11CPGP	291	TLL52FWB	216	UCL24CFB.....	227		
TL11RK	239	TLL54TB	217	UCL25CB.....	228		

4-INCH STOP, TURN, TAIL LAMPS



Base P/N	STL003RB	STL413RB	STL13RB	STL43RB	STL603RB	STL543RB
Also Available						
Brand	ONE LED LAMPS	FLEET COUNT	FLEET COUNT	GOPTRONICS LED	LIGHT GUIDE	HYPERX
LED Qty	1	4	7	10	12	12
Mounting	Recess Grommet Recess Flange	Recess Grommet Surface Mount Reflex Flange	Recess Grommet Recess Flange Surface Mount Reflex Flange	Recess Grommet Recess Flange Reflex Flange	Recess Grommet	Recess Grommet
Connections	 Locking PL3					
FMVSS	Red: S T I Yellow: 1 P White: (2) R	S2 T2 I6	Red: S T I Yellow: 16 P White: (2)R	Red: S T I P2 Yellow: 16 P White: (2)R	S2 T2 I6	S T I
Amp draw 12/24VDC	12.8VDC .007A Tail, .25A Stop	12.8VDC .008A Tail, .160A Stop	12.8VDC .033A Tail, .214A Stop	12.8VDC .027A Tail, .208A Stop 24VDC .014A Tail, .104A Stop	12.8VDC .114A Tail, .421A Stop	12.8VDC .043A Tail, .174A Stop
Tech Drawing						
Hole Cut-out	4.5"	4.5"	4.5"	4.5"	4.5"	4.5"
Retail						

Accessories

A45GB	BK45BB	A45PB	A47PB	A45PMB
Grommet, flush mount	Steel mounting bracket	Straight pigtail, 6"	Right angle pigtail, 10"	Weathertight plug to bare wire, 10"

LED LIFETIME WARRANTY

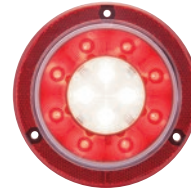

STL55RB	STL23RB	STL101RB	STL201XRB	STL201XRFHXB	STL201RFMB
21	12/16	21	20	20	24
Recess Grommet Recess Flange	Recess Grommet	Recess Grommet Recess Flange	Recess Grommet	Surface Mount Reflex Flange	Recess Flange
Red: S T I Yellow: I6 P	Red: S T I Yellow: I P	Red: S2 T2 I6 Yellow: I6 P White: (2)R	S2 T2 I6 (2)R	S2 T2 I6 (2)R A	S2 T2 I6 (2)R
12.8VDC .010A Tail, .280A Stop	12.8VDC .023A Tail, .181A Stop 24VDC .012A Tail, .091A Stop	12.8VDC .161A Tail, .361A Stop	12.8VDC / .240A Tail .265A Stop, .30A Back-Up	12.8VDC / .145A Tail .375A Stop, .30A Back-Up	12.8VDC / .139A Tail .324A Stop, .297A Back-Up
4.5"	4.5"	4.5"	4.5"	4.5"	4.5"



- Surface Mount Device
- Fewer connection points, fewer corrosion points
- Automated manufacturing increases production efficiency
- Thinner, more compact designs fit more applications



Better heat distribution



Increased durability

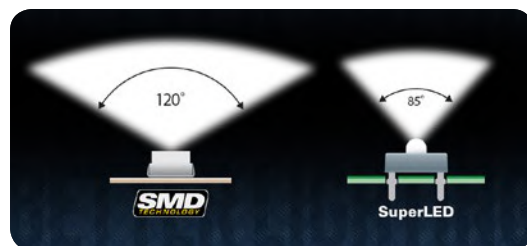

6-INCH STOP, TURN, TAIL LAMPS



Base P/N	STL002RB	STL412RB	STL12RB	STL72RB	STL512RB	STL572RB
Also Available				 Additional options available	 Clear lens, red LEDs	
Brand	ONE LED LAMPS	FLEET COUNT	FLEET COUNT	OptRONICS LED	HD500 SERIES	HYPERX
LED Qty	1	4	6	10	18	12
Mounting	Recess Grommet Surface Flange	Recess Grommet	Recess Grommet Surface Flange	Recess Grommet Surface Flange	Recess Grommet	Recess Grommet
Connections						
FMVSS	Red: S2 T2 I6 Yellow: I6 P White: (2) R	ST I	Red: S T I Yellow: I6 P White: (2) R	Red: S2 T2 I6 Yellow: I6 P White: (2) R	ST I	ST I
Amp draw 12/24VDC	12.8VDC .007A Tail, .25A Stop	12.8VDC .005A Tail, .14A Stop	12.8VDC .013A Tail, .161A Stop	12.8VDC .046A Tail, .243A Stop	12.8VDC .007A Tail, .174A Stop	12.8VDC .007A Tail, .174A Stop
Tech Drawing						
Hole Cut-out	6.85 x 2.5" (1.25" R)	6.85 x 2.5" (1.25" R)	6.85 x 2.5" (1.25" R)	6.85 x 2.5" (1.25" R)	6.85 x 2.5" (1.25" R)	6.85 x 2.5" (1.25" R)
Retail						

Accessories

A70GB	BK70BB	A45PB	A47PB	A45PMB
Grommet, flush mount	Steel bracket	Straight pigtail, 6"	Right angle pigtail, 10"	Weathertight plug to bare wire, 10"

LED LIFETIME WARRANTY

12V/24V					
STL22RB	STL602RB	STL111RB	STL70RB	STL1211RCFHPG	STL211XR
					Clear lens, red LEDs
12/16	22	22	48/56	22	16
Recess Grommet	Recess Grommet	Recess Grommet Recess Flange Surface Flange	Recess Grommet	Surface Flange	Recess Grommet Surface Flange
S T I	Red: S2 T2 I6 White: (2) R	Red: S2 T2 I6 Yellow: I6 P White: (2)R	Red: S T I P2 Yellow: I P2 P	S2 T2 I6 (2)R	S T I (2)R
12.8VDC .007A Tail, .187A Stop	12.8VDC .007A Tail, .187A Stop	12.8VDC / .268A Tail, .582A Stop, .386A Back-up	12.8VDC .054A Tail, .362A Stop	12.8VDC / .02A Tail, .375A Stop, .242A Back-Up	12.8VDC / .020A Tail, .375A Stop, .242A Back-up
6.85 x 2.5" (1.25" R)	6.85 x 2.5" (1.25" R)	6.85 x 2.5" (1.25" R)	6.85 x 2.5" (1.25" R)	7.52 x 3.25" (1.25" R)	6.85 x 2.5" (1.25" R)

SMD LED TECHNOLOGY



- Surface Mount Device
- Fewer connection points, fewer corrosion points
- Automated manufacturing increases production efficiency
- Thinner, more compact designs fit more applications









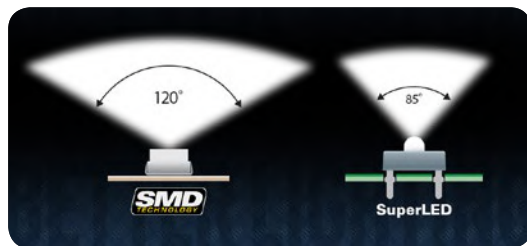

Better heat distribution



Increased durability



									
Raw Lumen	4800	4000	3200	2400	2160	2160	2160	2160	2160
Effective Lumen	3360	2800	2240	1680	1510	1492	1490	1490	1490
Bulk P/N	TLL70FB	TLL56FB	TLL64FB	TLL149FB	TLL55FB	TLL-46CFB	TLL71FB	TLL72FB	TLL73FB
LEDS	6 SMD	8 SMD	4 SMD	10 SMD	9 SMD	9 SMD	9 SMD	9 SMD	9 SMD
Beam	Flood	Flood	Flood	Flood	Flood	Flood	Flood	Flood	Flood
Lens	Poly-carbonate	Poly-carbonate	Poly-carbonate	Poly-carbonate	Poly-carbonate	Poly-carbonate	Poly-carbonate	Poly-carbonate	Poly-carbonate
Housing	Aluminum	Aluminum	Aluminum	Aluminum	Aluminum	Aluminum	Aluminum	Aluminum	Aluminum
Hardware	Stainless Steel	Stainless Steel	Stainless Steel	Stainless Steel	Stainless Steel	Stainless Steel	Stainless Steel	Stainless Steel	Stainless Steel
Weight	1.41 lbs.	3.53 lbs.	1.41 lbs.	.95 lbs.	1.35 lbs.	1.50 lbs.	1.41 lbs.	1.5 lbs.	1.61 lbs.
Dims	4.375"W 5.375"H 2.625"D	7.161"W 6.093"H 4.313"D	4.187"W 5.375"H 3.0"D	6.625"W 3.5"H 2.665"D	4.875"W 6.5"H 2.0"D	5.0"W 5.75"H 2.375"D	4.0"W 5.0"H 2.25"D	5.0"W 5.375"H 2.25"D	5.0"W 7.5"H 3.25"D
IP Rating	IP69K	IP69K	IP69K	IP69K	IP69K	IP69K	IP69K	IP69K	IP69K
Amp Draw 12.8VDC	2.8A	3.7A	2.9A	2.05A	1.5A	1.65A	1.43A	1.43A	1.43A
Amp Draw 24VDC	1.43A	2A	1.5A	.97A	.73A	1.0A	.66A	.66A	.66A

 - Wide Angle Beam

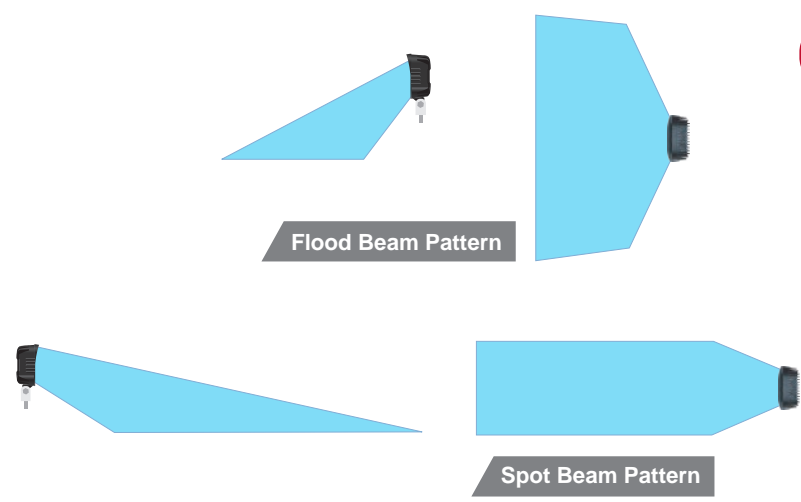

IP69K RATING

Highest designation available for water ingress testing, offering increased reliability and service life when subjected to severe environmental conditions or cleaning methods.