

MATRA[®]

DEAR CUSTOMERS AND FRIENDS,

1946 was the beginning of Metra Electronics in Brooklyn, NY, starting as a small TV sales and repair shop called Metro TV. Through contacts and friends at New York's Taxicab commission Metra's founder, who happened to be an engineer, was asked to help design brackets to be able to retrofit an AM radio into taxi cabs. That was the beginning of automotive aftermarket manufacturing for Metra 75 years ago.

The parts that were made back then are decidedly different than what we make today but the mission is still the same. We make the parts that are needed to be able to add aftermarket equipment to vehicles. We are proud to be able to continue that mission and we are proud that we will be able to for decades to come.

2020 was a very unprecedented year. The Covid pandemic had very unexpected influences on our business. We had to put in place new policies and procedures that would allow our facility to stay open so we could continue to produce products for a business that was having tremendous growth. Like everyone however, we had to cope with shipping delays, raw material shortages and pricing pressure. But through it all we persevered and now we can see the light at the end of the tunnel.

We still continue to provide more new products than anyone else in our industry. We have added many new dash kits, speaker adaptors and harnesses. We have added new items to our Axxess, Heise, Daytona Lights, Metra PowerSports, Raptor, T-spec and The Install Bay lines. We have also made improvements to our digital presence. We are updating websites and are in the process of improving all of our content. Online is an important form of communication to both our customers and our customer's customer. We understand that this is the channel people use the most to get their information about which choices to make when it comes to items they need and want. Therefore, we have made the necessary investments in order to support and improve our online presence.

Thank you so very much for your continued support of Metra Electronics. Obviously, none of us have been here for the entire 75 years of Metra's existence. But we do know and follow our history. We understand that the obligation Metra has to the mobile electronics and automotive accessory businesses is very important. And it is our responsibility to provide the best products and service necessary to make the installer's jobs easier and more profitable. Our commitment to that obligation is to continue to improve and strive to provide the best of the best for another 75 years.

Warmest Regards,

Bill Jones
President/CEO
Metra Electronics Corp.



THE INSTALLER'S CHOICE

CORPORATE MISSION

To enthusiastically and aggressively approach any opportunity to utilize our braintrusts, facilities, strategies, alliances and capital for the advancement of our employees and stakeholders.

There will be no limitations as we strive to create, innovate, manufacture and deliver high quality, good value products to not only satisfy but also astonish our customers.

By following our vision and attaining high levels of honesty and integrity, we will experience the joy of competition and winning.

FIND THE PARTS TO FIT YOUR VEHICLE



Download our Vehicle Fit Guide app for Android™ or iOS® or you can visit to search by product or by vehicle and obtain a product picture and instruction manual.

To find a product by part #, look it up in the Product Locator section of this catalog.

TABLE OF CONTENTS

- Turbo Kits®1-139**
- Multi-Kit Reference Guide.....140-143**
- Merchandise 144**
- Turbo Wires..... 145-172**
- Installer Works..... 173-186**
- AntennaWorks® 187-208**
- Product Locator..... 209-236**
- Terms and Conditions..... 237**



WARNING: This catalog does not advise whether a State of California Proposition 65 warning is required for a particular item of merchandise. To learn whether a particular item of merchandise requires a California Proposition 65 warnin. When a California Proposition 65 warning is present on Metra's website listing for the particular merchandise, or on the particular merchandise's packaging, a compliant California Proposition 65 warning is to be provided to the purchasing California consumer prior to the sale of the particular merchandise.

Turbo **Kit's**®

Metra's Turbo Kits are manufactured of OEM-quality ABS plastic and designed with exacting tolerances. Each matches the factory dash contours perfectly - with no gaps between the dash and the kit. From basic to custom installs, perfection starts here.

Turbo *Kit's*®



99-6000

CHRYSLER | PLYMOUTH | DODGE | JEEP
EAGLE **Multi-Kit** 1974-2003**

- Includes add-on corner support components that eliminate any flexing or rocking of the kit
- Molded under-radio CD jewel case pocket
- See Multi-Kit guide at the end of this section for applications



99-6229

CHRYSLER | PLYMOUTH | DODGE | JEEP
Multi-Kit 1974-2003**

- Includes easy-to-use instructions and hardware
- See Multi-Kit guide at the end of this section for applications



99-6500

CHRYSLER | PLYMOUTH | DODGE | JEEP | EAGLE
FORD | LINCOLN | MERCURY **Multi-Kit** 1974-2003**

- Includes alignment pins for fast, positive installation in Chrysler, Plymouth and Dodge vehicles
- See Multi-Kit guide at the end of this section for applications

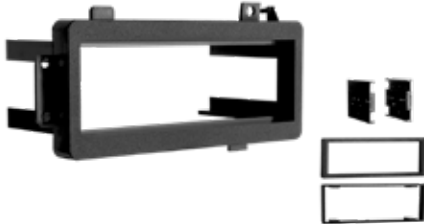

99-6501

CHRYSLER | PLYMOUTH | DODGE | JEEP | EAGLE |
FORD | LINCOLN | MERCURY **Multi-Kit** 1974-2003**

- Includes recessed Single-DIN opening with adjustable depth feature
- Designed to ISO mount radios with ISO trim ring
- Radio side support is provided by our patented "Side Arm Support System"™



99-6502

CHRYSLER **Cirrus** | DODGE **Stratus 1995-2000**
PLYMOUTH **Breeze 1996-1999**
CHRYSLER **Sebring Convertible 1996-2000**

- Includes recessed Single-DIN opening



99-6503

JEEP | CHRYSLER | PLYMOUTH | DODGE
Multi-Kit 1998-2010R**

- Special design accommodates Single-DIN radios
- Bolts directly to factory radio mounting locations
- See Multi-Kit guide at the end of this section for applications



99-6504

JEEP | CHRYSLER | PLYMOUTH | DODGE
Multi-Kit 1998-2010**

- Specially designed for ISO mount radios
- Comes with under-radio CD jewel case pocket
- See Multi-Kit guide at the end of this section for applications



99-6505

CHRYSLER | JEEP | DODGE | PLYMOUTH
Multi-Kit 1998-2009**

- Metra's patented snap-in ISO support system
- Recessed Single-DIN mount
- ISO trim ring
- See Multi-Kit guide at the end of this section for applications



95-6506B

CHRYSLER **Pacifica 2004-2008**

- Designed specifically for the installation of Double-DIN radios
- Painted scratch-resistant matte black



CHRYSLER + JEEP + DODGE + RAM + FIAT



99-6506

CHRYSLER **Pacifica** 2004-2008

- Holds either Single-DIN or ISO DIN units
- Metra's patented quick release snap-in ISO mounting system with ISO trim ring



99-6507

CHRYSLER | DODGE | JEEP **Multi-Kit**** 2004-2010

- Metra's patented quick release snap-in ISO mounting system with ISO trim ring
- Recessed Single-DIN mount with pocket
- See Multi-Kit guide at the end of this section for applications



99-6509

DODGE **Sprinter** 2003-2006

FREIGHTLINER **Sprinter** 2003-2006

- High-grade ABS plastic contoured and textured to compliment factory dash



99-6510



CHRYSLER | DODGE | JEEP **Multi-Kit**** 2004-2009

- Designed specifically to replace Chrysler navigation radios
- Includes parts for installation of Double-DIN radios
- Pocket included for Single-DIN installations
- See Multi-Kit guide at the end of this section for applications



95-6511



CHRYSLER | DODGE | JEEP **Multi-Kit**** 2007-UP*

- New design allows for better fit of standard Double-DIN radios and includes secondary parts for short-nosed radio faces
- For classic design, use 95-6511-17
- See Multi-Kit guide at the end of this section for applications



99-6511

CHRYSLER | DODGE | JEEP **Multi-Kit**** 2007-UP*

- Metra's patented quick release snap-in ISO mounting system with ISO trim ring
- Recessed Single-DIN opening
- See Multi-Kit guide at the end of this section for applications



99-6512



DODGE **Sprinter** 2007-2009

FREIGHTLINER **Sprinter** 2007-2018

MERCEDES-BENZ **Metris** 2016-UP*

MERCEDES-BENZ **Sprinter** 2010-2018

- Metra's patented quick release snap-in ISO mounting system with ISO trim ring
- Recessed Single-DIN opening
- Includes parts for installation of Double-DIN radios



95-6513B



JEEP **Grand Cherokee** 2011-2013

DODGE **Durango** 2011-2013

- For installation of Double-DIN use 95-6513B
- For installation of Single-DIN use 99-6513B
- Painted matte black to match factory color and finish



99-6513B



JEEP **Grand Cherokee** 2011-2013

DODGE **Durango** 2011-2013

- For installation of Double-DIN use 95-6513B
- For installation of Single-DIN use 99-6513B
- Painted matte black to match factory color and finish



Included interface retains factory 4.3" touch screen

Climate controls down low allow space for Double-DIN radio

99-6514B Turbo P D

DODGE Charger 2011-2014

- Designed with an included interface to retain the factory screen and place the aftermarket unit in the original climate control locations
- Backlit, rubber buttons to control climate functions or just control them from the factory touchscreen
- Interface also provides a video input to the factory 4.3" screen



99-6515B P

FIAT 500 2012-2015

- Designed specifically for the installation of Single-DIN aftermarket radios
- Painted scratch-resistant matte black to match factory color and finish



99-6515W P

FIAT 500 2012-2015

- Designed specifically for the installation of Single-DIN aftermarket radios
- Painted scratch-resistant matte white to match factory color and finish



99-6516B P D

CHRYSLER 300 2005-2007

- The larger panel is painted matte black and replaces the need for the OEM NAV panel
- The included 99-6510 mounting kit makes this an all-in-one solution



95-6517HG P D

DODGE Dart 2013-2016 (without factory 8.4" screen)

- Designed for Double-DIN installations
- Painted high gloss black to match the factory color and finish

Manufactured under one or more of the following U.S. Patents and pending applications #D725096



99-6517HG P

DODGE Dart 2013-2016 (without factory 8.4" screen)

- Pocket included for Single-DIN installations
- Painted high gloss black to match the factory color and finish

Manufactured under one or more of the following U.S. Patents and pending applications #D725096



95-6518B P D

CHRYSLER | JEEP | RAM Multi-Kit 2013-UP*** (without factory 8.4" screen)

- Double-DIN installations
- Painted scratch-resistant matte black
- See Multi-Kit guide at the end of this section for applications

Manufactured under one or more of the following U.S. Patents and pending applications #D770439



99-6518B P

CHRYSLER | JEEP | RAM Multi-Kit 2013-UP*** (without factory 8.4" screen)

- Pocket included for Single-DIN installations
- Painted scratch-resistant matte black
- See Multi-Kit guide at the end of this section for applications

Manufactured under one or more of the following U.S. Patents and pending applications #D770439

CHRYSLER + JEEP + DODGE + RAM + FIAT



99-6519B



DODGE Charger 2005-2007 (without factory NAV)
 • Painted matte black and replaces the need for the OEM NAV panel
 • Includes the 99-6510 mounting kit



99-6519S



DODGE Charger 2005-2007 (without factory NAV)
 • Painted silver and replaces the need for the OEM NAV panel
 • Includes the 99-6510 mounting kit

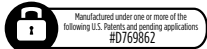

99-6519CF



DODGE Charger 2005-2007 (without factory NAV)
 • Finished in carbon fiber and replaces the need for OEM NAV panel
 • Includes the 99-6510 mounting kit



Integrated buttons and included interface retain most climate functions



Interface included!

99-6520B Turbo



DODGE Journey 2011-UP*
 • Includes interface to retain factory 4.3 inch screen
 • Intelligent design uses space in the center console
 • New backlit, rubber buttons to control climate functions or control from the factory touchscreen
 • Use 40-EU10 antenna adapter for a complete installation (sold separately)



95-6521B



FIAT 500L 2014-UP*
 • Designed for Double-DIN installations
 • Painted scratch-resistant matte black



99-6521B



FIAT 500L 2014-UP*
 • Pocket included for Single-DIN installations
 • Painted scratch-resistant matte black



95-6522B



DODGE Ram 1500 2002-2005
Ram 2500 | 3500 2003-2005
 • Designed for installation of Double-DIN radios
 • Custom redesigned factory dash piece with Double-DIN opening
 • No glue required
 • Use 70-6502 harness and 40-CR10 antenna adapter for a complete installation (sold separately)



95-6523



RAM Promaster (with 5" screen) 2014-UP*
 • Specific for Double-DIN installations
 • Custom texture to match factory finish

CHRYSLER + JEEP + DODGE + RAM + FIAT



99-6523 T

RAM Promaster (with 5" screen) **2014-UP***

- Pocket included for Single-DIN installations
- Custom texture to match factory finish



95-6524B P D

JEEP Liberty 2002-2007

- Painted scratch-resistant matte black
- Specific for Double-DIN installations
- This panel replaces the factory dash panel and provides space for a modern Double-DIN radio



99-6525B Turbo P D

CHRYSLER 300 2011-2014

- Included interface with new technology allows retention of most necessary functions of the factory touchscreen
- Parts included for Single-DIN or Double-DIN installations
- Painted black to match the factory color and finish



99-6525HG Turbo P D

CHRYSLER 300 2011-2014

- Included interface with new technology allows retention of most functions of the factory touchscreen
- Parts included for Single-DIN or Double-DIN installations
- Painted gloss black to match the factory color and finish



99-6526S Turbo P D

JEEP Cherokee Latitude Limited 2014-UP*

- The included interface retains climate control functions and displays status on the aftermarket radio screen
- Intended for installation of Double-DIN radios with a backup camera input
- Mechanically designed for a two-tone paint scheme to properly match the factory silver color



99-6526BZ Turbo P D

JEEP Cherokee Latitude Limited 2014-UP*

- The included interface retains climate control functions and displays status on the aftermarket radio screen
- Intended for installation of Double-DIN radios with a backup camera input
- Mechanically designed for a two-tone paint scheme to properly match the factory bronze color



99-6527B Turbo Touch P D

RAM Truck 2013-2017 (with 5" or 8" touchscreen)

- For ISO DIN with pocket and ISO DDIN radio provision
- Integrated 4.3 inch color touchscreen that displays the factory climate and personalization features
- Built-in AXSWC technology retains factory steering wheel controls
- Painted black to match the factory finish
- Antenna adapter included for a complete installation

CHRYSLER + JEEP + DODGE + RAM + FIAT



95-6528B



DODGE Ram 1500 2006-2008
Ram 2500 | 3500 2006-2009
Ram 2500 | 3500 Chassis Cab 2006-2010

- Custom design allows for Double-DIN installations with minimal dash modifications
- Painted scratch-resistant matte black



95-6531HG



RAM Promaster City 2015-UP*

- Designed specifically for the installation of ISO Double-DIN radios
- Two sets of brackets adapt and provide solid radio support
- High gloss black trim plate to match factory color and finish



99-6531HG



RAM Promaster City 2015-UP*

- Designed specifically for Single-DIN installations
- Two sets of brackets adapt and provide solid radio support
- High gloss black trim plate to match factory color and finish



95-6532B



JEEP Renegade 2015-UP*

- Designed specifically for the installation of ISO Double-DIN radios
- Painted scratch-resistant matte black



99-6532B



JEEP Renegade 2015-UP*

- Designed specifically for single ISO Single-DIN installations
- Painted scratch-resistant matte black



95-6533B



CHRYSLER PT Cruiser 2006-2010
DODGE Durango 2004-2007
JEEP Grand Cherokee 2005-2007

- Custom design allows for ISO Double-DIN installations
- Painted scratch-resistant matte black
- Included template to guide cutting factory dash panel



95-6534B



JEEP Patriot | Compass 2007-2008
DODGE Caliber 2007-2008 (without NAV)

- Custom design allows for ISO Double-DIN installations with minimal dash modifications
- Painted scratch-resistant matte black
- Included template to guide in cutting the factory dash panel



95-6535B



FIAT 500X 2016-UP*

- Radio is extended from the dash to avoid major sub-dash modifications
- Designed specifically for the installation of Double-DIN radios
- Painted scratch-resistant matte black



Quick access to Metra's parts, specs, products info and more! Download it **FREE**



Interface included!



99-6536S



JEEP Grand Cherokee 2014-2017

- Designed for ISO Single-DIN with pocket and ISO Double-DIN radio provision
- Touchscreen display for climate and personalization features
- Painted black with silver trim
- Axxess interface and harness included
- Antenna adapter included for a complete installation

MetraDealer.com
Register online today!

For more information please call your sales representative at 386-257-2956



Interface included!



99-6536BZ



JEEP Grand Cherokee 2014-2017

- Designed for ISO Single-DIN with pocket and ISO Double-DIN radio provision
- Touchscreen display for climate and personalization features
- Painted black with bronze trim
- Axxess interface and harness included
- Antenna adapter included for a complete installation



Interface included!



99-6537B



DODGE Durango 2014-2017

- For radio provision ISO Single-DIN with pocket and ISO Double-DIN
- HVAC interface, Axxess interface and wiring harness included
- Built-in AXSWC technology retains steering wheel controls
- Painted black to match factory finish
- Antenna adapter included for a complete installation

Included interface shows climate and menu info on the aftermarket radio screen



Interface included!



99-6538B



CHRYSLER 200 2015-2017 (excludes models with factory 3.0" screen)

- Included interface retains climate control functions and displays status information on aftermarket radio screen
- For installation of Single-DIN and Double-DIN radios
- Painted scratch-resistant matte black with silver trim
- Antenna adapter included for a complete installation



Manufactured under one or more of the following U.S. Patent and pending applications: #D8,269,20

95-6539



DODGE Caravan 2001-2007

CHRYSLER Town & Country 2001-2007

- Replacement of the factory center panel allows for a Double-DIN installation
- Blank plates and stickers included to accommodate multiple trim levels
- No custom work or cutting of the factory bezel required



CHRYSLER + JEEP + DODGE + RAM + FIAT



99-6540

DODGE Full-Size Van 1990-1997

- Professional Installer Series TurboKit includes vehicle specific trim panel and radio housing



95-6541



JEEP Wrangler 2003-2006

- Replacement of the factory center panel allows for a Double-DIN installation
- No custom work or cutting of the factory bezel required
- Textured for a clean factory appearance

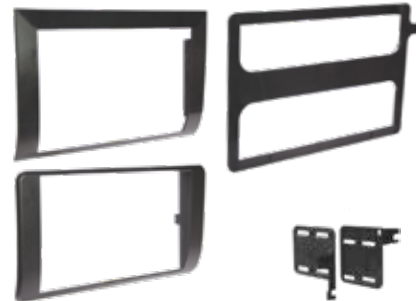

95-6542



DODGE Durango 1998-2000

Dakota 1997-2000

- Unique design allows Double-DIN installation in a tight spot
- Templates are included for factory dash modifications



99-6543HG



CHRYSLER Pacifica (Limited/Touring) 2017-2017

- Designed for Single-DIN with pocket and Double-DIN radio provision
- Touchscreen display for climate and personalization features
- Painted high gloss black with silver trim

Note: The 360 surround camera is not supported at this time



95-6545B



JEEP Compass Sport 2017.5-2018

- Designed specifically for the installation of Double-DIN radios
- Painted scratch-resistant matte black to match the factory color and finish



95-6544B



FIAT 500 | 500C | 500e 2016-2019

- Specifically designed for Double-DIN installations
- Painted scratch-resistant matte black to match the factory finish



99-6544B



FIAT 500 | 500C | 500e 2016-2019

- Includes a pocket for Single-DIN installations
- Painted scratch-resistant matte black to match the factory finish



99-6545B



JEEP Compass Sport 2017.5-2018

- Includes parts for the installation of Single-DIN radios
- Painted scratch-resistant matte black to match the factory color and finish

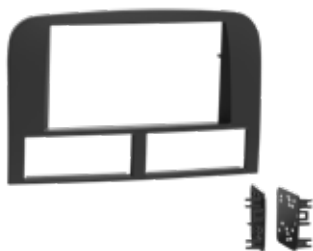

95-6546B



JEEP Grand Cherokee 1999-2004

- ISO Double-DIN radio provision
- Designed specifically for the installation of Double-DIN radios
- Complete radio panel for a factory look
- Painted scratch-resistant matte black



95-6547B



DODGE Dakota 2001-2004 | Durango 2001-2003

- ISO Double-DIN radio provision
- Designed for the installation of Double-DIN radios
- Includes a contoured Double-DIN trim as well as a template for easy modification to the factory panel



99-6548B



DODGE Charger | Magnum 2005-2007 (without NAV)

- ISO Single-DIN radio provision with pocket
- ISO Double-DIN radio provision
- Complete center panel for a factory look, no cutting required to the factory panel
- Painted scratch-resistant matte black



99-6548CF



DODGE Charger | Magnum 2005-2007

(without NAV)

- ISO Single-DIN radio provision with pocket
- ISO Double-DIN radio provision
- Complete center panel for a factory look, no cutting required to the factory panel
- Carbon fiber hydro dipped to match the factory finish

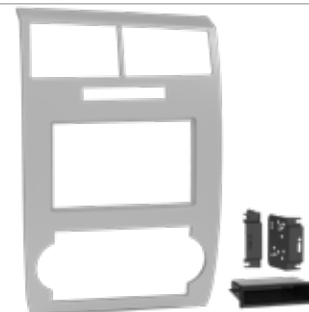

99-6548S



DODGE Charger | Magnum 2005-2007

(without NAV)

- ISO Single-DIN radio provision with pocket
- ISO Double-DIN radio provision
- Complete center panel for a factory look, no cutting required to the factory panel
- Painted silver match the factory finish



95-6549



JEEP Wrangler 1997-2002

- Metra's patented quick release, snap-in ISO mount system with custom trim ring
- Recessed DIN opening and removable oversized storage pocket with built-in radio supports
- Painted matte black to match OEM color and finish

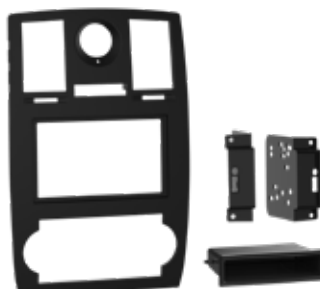

99-6550B



CHRYSLER 300 2005-2007

- Parts provided for the installation of ISO Single-DIN and Double-DIN radios
- Painted scratch-resistant matte black
- New design of factory panel with aftermarket Double-DIN radio opening



CHRYSLER + DODGE + FIAT + JEEP



95-6551



DODGE RAM 1998-2001

- Double-DIN specific mounting solution
- Custom textured to match the factory appearance
- Cutting template included to simplify the modification of the factory dash panel



DP-6551



DODGE RAM 1998-2001

- Double-DIN specific mounting solution
- Custom textured to match the factory appearance
- Cutting template included to simplify the modification of the factory dash panel



99-6552B



NEW TECH



DODGE Charger 2015-UP*

- An all new seven inch touchscreen with buttons will retain and control all climate and most vehicle customization functions normally lost when removing factory radio components
- Patent pending touchscreen design also retains the factory steering wheel functions and safety features including the backup camera
- Painted scratch-resistant matte black to match the factory appearance



99-6553B



NEW TECH



CHRYSLER 300 2015-UP*

- An all new seven inch touchscreen with buttons will retain and control all climate and most vehicle customization functions normally lost when removing factory radio components
- Patent pending touchscreen design also retains the factory steering wheel functions and safety features including the backup camera
- Painted scratch-resistant matte black to match the factory appearance



95-6554B



JEEP Cherokee 1997-2001

- ISO Double-DIN radio provision
- Complete panel for a factory look and feel
- Painted scratch-resistant matte black





95-6555B

COMPACT CHASSIS
TOP MOUNT **P**

DODGE **RAM** 1994-1997

- Designed for radios with an "L" shaped chassis design, with the radio chassis at the top of the screen, like Sony models XAV-AX100, XAV-AX1000, XAV-AX200, XAV-A500, and XAV-V10BT. Refer to the radio manufacturer for current models
- Painted scratch-resistant matte black
- Cutting template included to simplify modification



95-6556DK

P D

JEEP **Commander** 2006-2007

- ISO Double-DIN radio provision
- Complete panel for a factory look and feel
- Painted scratch-resistant matte black



95-6556G

P D

JEEP **COMMANDER** 2006-2007

- Designed for ISO Double-DIN installations
- Painted gray to match the factory dash panel

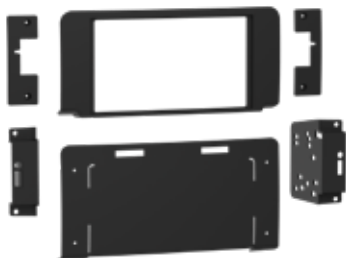

95-6557B

P D

DODGE **Dakota** 2005-2007

- ISO Double-DIN radio provision
- Painted scratch-resistant matte black
- Includes cutting template and a trim panel to cover the cut, providing a Double-DIN solution into the factory panel



InstallBay
INSTALLATION HARDWARE



CHRYSLER + JEEP + DODGE + FORD + LINCOLN

99-6700

CHRYSLER | PLYMOUTH | DODGE | JEEP EAGLE
FORD | LINCOLN | MERCURY **Multi-Kit** 1974-2003**

- Includes corner support components that eliminate the flexing or rocking of the kit that has been experienced with other kits on the market
- Radio side support is provided by our patented "Side Arm Support System™"
- See Multi-Kit guide or Application Chart of this catalog for applications

99-7000

PLYMOUTH | DODGE | EAGLE | MITSUBISHI
IMPORTS **Multi-Kit** 1985-1996**

- Allows pocket retention
- Includes snap-in center bar when replacing factory Double-DIN radio
- Provision allows installation of 1/4 or 1/2-DIN equalizer - Includes EQ side supports
- See Multi-Kit guide or Application Chart of this catalog for applications

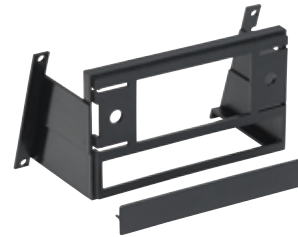
99-7006

EAGLE **Talon** | MITSUBISHI **Eclipse 1995-1999**

- Quick conversion from 2-shaft to DIN
- Allows installation of 1/4 or 1/2-DIN equalizer

FORD

86-5618

FORD **Radio Removal Tool 1987-2011**

- One pair of removal tools for removing factory Ford, Lincoln, Mazda, Mercury, GM and a variety of European factory radios 1987-up*

98-5999

FORD **Turbo Pocket**

- Trim ring blends the pocket to the dash for a factory look
- Holds three CD jewel cases

95-5000B

FORD **Thunderbird 2002-2005**

LINCOLN **LS 2000-2006**

- Designed for the installation of Double-DIN radios
- Painted black to match the OEM finish

95-5000S

FORD **Thunderbird 2002-2005**

LINCOLN **LS 2000-2006**

- Designed specifically for the installation of Double-DIN radios
- Painted silver to match the OEM finish

99-5000

FORD **Thunderbird 2002-2005**

LINCOLN **LS 2000-2006**

- Provides pocket with recessed mounting of a DIN radio or an ISO DIN radio using Metra's patented ISO quick-release brackets

95-5025

FORD **Mustang 1987-1993**

- Designed specifically for the installation of Double-DIN radios



99-5025

FORD **Mustang 1987-1993**

- Pocket included for Single-DIN installations
- See Multi-Kit guide or Application Chart of this catalog for applications



95-5026



FORD **Expedition 2003-2006**
Explorer 2002-2005 | **Mustang 2001-2004**
 LINCOLN **Aviator 2003-2005**
Navigator 2003-2006
 MERCURY **Mountaineer 2002-2005**

- Designed specifically for the installation of Double-DIN radios



99-5026

FORD **Mustang 2001-2004**
Explorer 2002-2005 | **Expedition 2003-2005**
 LINCOLN **Aviator 2003-2005**
Navigator 2003-2006
 MERCURY **Mountaineer 2002-2005**

- Provides pocket with recessed mounting of a DIN radio or ISO DIN radio



Trim pieces allow for a true Multi-Kit to fit two different dash openings

99-5027

FORD **Multi-Kit** 1995-2011**

- Unique design with two trim pieces allows the kit to cover more applications
- Oversized storage pocket molded to the main housing



Includes a textured trim

95-5028 / 99-5028



FORD **Expedition** | LINCOLN **Navigator 2003-2006** (with factory NAV)

- With factory navigation, all 2003 models are late production only and all Navigator models equipped without THX audio
- 95 - Double-DIN installations
- 99 - Pocket included for Single-DIN installations
- Use 70-1776 harness (excluding THX) for a complete installation (sold separately)



99-5200

MERCURY **Cougar 1999-2002**
 FORD **Focus 2000-2004**

- Single-DIN radio provision with pocket
- Molded pocket for a seamless look
- Includes radio support bracket
- For Double-DIN installations use 95-5806

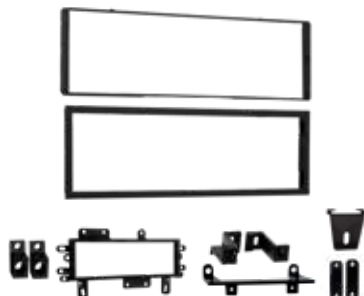

99-5510

FORD | LINCOLN | MERCURY
Multi-Kit 1982-2000**

- OEM-style rear support included



99-5512

FORD | LINCOLN | MERCURY | MAZDA
Snap-In Style Radio Replacement Multi-Kit 1989-2000**

- Combined with 88-00-9000, will fill OEM Double-DIN openings



99-5600

FORD | LINCOLN | MERCURY | MAZDA
Multi-Kit 1995-2011**

- Now without the old 1/2 DIN EQ opening
- New design with improved strength for support

FORD + LINCOLN + MERCURY



99-5700

FORD | LINCOLN | MERCURY | JEEP | EAGLE
AMC | MAZDA | NISSAN Multi-Kit** 1975-1996

- Fits all Single-DIN radios
- Bracket system allows recessed or flush mounting



95-5701



FORD F-Series Trucks | Bronco 1992-1996
F-250 | F-350 1997

- ISO Double-DIN radio provision
- Textured to match the factory finish
- Detailed instructions explain a small cut to the factory dash panel, and a trim panel covers the cut

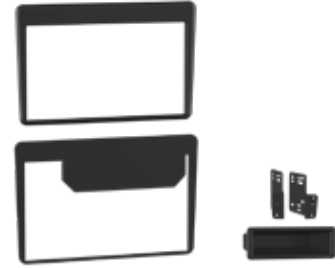

95-5702



FORD Aerostar 1992-1997

- Double-DIN specific mounting solution
- Custom textured to match the factory appearance
- Cutting template included to simplify the modification of the factory dash panel



95-5703



FORD Mustang 1994-2000

- Replacement dash panel for a Double-DIN specific mounting solution
- Painted scratch-resistant matte black

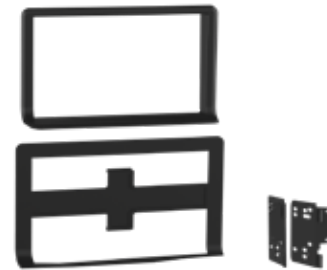

95-5704



FORD Econoline 1992-1996

- Double-DIN specific mounting solution
- Custom textured to match the factory appearance
- Cutting template included to simplify the modification of the factory dash panel

Electroluminescent light source duplicates OEM technology



Laser etched, LED backlit defroster switch for an OEM look

99-5715 Turbo

FORD Taurus | MERCURY Sable 1996-1999 (without electronic climate controls)

- Uses factory climate controls
- Includes rear window defroster switch & A/C control illumination
- Requires the 70-5715 harness
- Requires the 70-5716 harness for models 98-99

Electroluminescent light source duplicates OEM technology



Laser etched, LED backlit defroster switch for an OEM look

99-5715LD Turbo

FORD Taurus | MERCURY Sable 1996-1999 (without electronic climate controls)

- Uses factory climate controls
- Includes rear window defroster switch & A/C control illumination
- Comes with wire harness and antenna extension
- Requires the 70-5716 harness for models 98-99

Electroluminescent light source duplicates OEM technology



Laser etched, LED backlit defroster switch for an OEM look

99-5715LDS Turbo

FORD Taurus | MERCURY Sable 1996-1999 (without electronic climate controls)

- Uses factory climate controls
- Includes rear window defroster switch and A/C control illumination
- Comes complete with wire harness and antenna extension to run to trunk

Electroluminescent light source duplicates OEM technology



Laser etched, LED backlit defroster switch for an OEM look

99-5716 | 99-5717 Turbo

FORD Taurus | MERCURY Sable 2000-2007 (without electronic A/C)

- Uses factory climate controls
- Use factory spring clips to allow kit to snap into the dash
- 99-5717 includes airbag indicator light for 2004-2007 models
- Comes complete with wire harness and antenna extension to run to trunk

FORD + LINCOLN + MERCURY



99-5718 | 99-5719 *Turbo* P D

FORD **Taurus** | MERCURY **Sable 2000-2007** (without electronic A/C)

- Double-DIN radio provision
- Integrated climate controls
- Backlit soft touch rubber buttons with laser etched climate icons
- Includes airbag indicator light
- **99-5719** includes airbag indicator light for 2004-2007 models
- LCD display to show status
- ISO stacked radio provision
- Painted a scratch-resistant matte black finish
- All harnesses and antenna adapters included

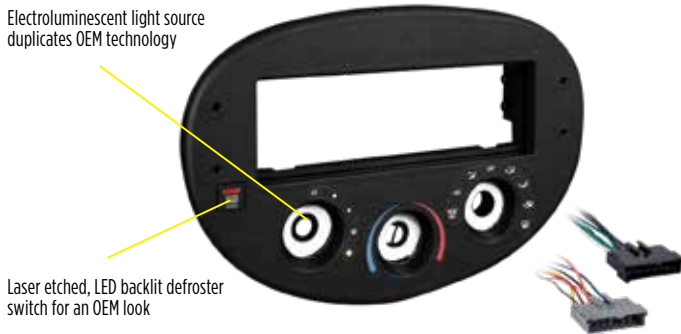

99-5720 *Turbo*

FORD **Escort** | MERCURY **Tracer ZX2 1997-2003**

- Fits the Escort's radio opening perfectly and all functions are pre-wired for an easy plug-in installation
- Includes nighttime illumination and rear window defroster switch
- Utilizes the factory climate control switches
- The power and 4-speakers harness is included with the kit (2003 models also require the 70-5720)



99-5722 *Turbo Touch* P D

FORD **Taurus 2010-2012** (excluding NAV equip. models)

- Includes features for dual zone climate equipped cars
- For installation of both Double-DIN and Single-DIN radios
- Retains all factory climate control functions with soft touch buttons and LCD display
- ISO stacked radio provision
- Retains heated seats and compass if equipped
- Built-in AXSWC technology retains factory steering wheel controls
- Painted charcoal to match the OEM finish



99-5800

FORD **F-150 Truck** | **Expedition 1997-1998**

- Built-in pocket
- Can be installed with the pocket on the top or on the bottom
- The kit will mount a recessed Single-DIN radio so that no modification to the dash is needed



99-5801

FORD **F-150 Truck** | **Expedition** (without pocket) **1997-1998**

- Accommodates Single-DIN radios with a recessed opening
- Fits contour of dash with no gaps
- The kit will mount a recessed Single-DIN radio so that no modification to the dash is needed



Reinforced sides for better stability during shipping

99-5802

FORD | LINCOLN | MERCURY | MAZDA

Multi-Kit 1995-2011**

- Now with reinforced sidewalls for better stability during shipping
- Designed with support ribs to provide a stronger DIN opening and pocket
- OEM-style rear-support included



99-5804

FORD | LINCOLN | MAZDA | MERCURY **Truck Multi-Kit** 1995-2009**

- Designed for DIN-mount radios
- Pocket holds one CD jewel case



95-5806



FORD **Focus 2000-2001**
MERCURY **Cougar 1999**

Cougar (without 6-disc radio) **2000-2002**

- Designed specifically for the installation of Double-DIN radios



99-5806

FORD **Focus 2000-2004** | MERCURY **Cougar 1999** | **Cougar** (without 6-disc radio) **2000-2002**

- Metra's patented quick release snap-in ISO mounting system with ISO trim ring
- Recessed DIN Radio Provision



99-5807



FORD | MERCURY **Multi-Kit** 2004-2010**

- Metra's patented quick release snap-in ISO mounting system with ISO trim ring
- Recessed DIN mount
- Double-DIN trim plate and brackets



99-5808

FORD | MERCURY **Multi-Kit** 2004-2007**

- Metra's patented quick release snap-in ISO mounting system with ISO trim ring
- Recessed DIN mount

Knowledge is Power

Advance your skills in the field of Custom Installation!



FORD + LINCOLN + MERCURY



95-5809



LINCOLN Continental 1998-2002

- Specifically designed for the installation of aftermarket Double-DIN radios
- Compliments the existing 99-5809 for Single-DIN installations



99-5809

LINCOLN Continental 1998-2002

- Recessed DIN opening
- Metra's patented quick release snap-in ISO mounting system with ISO trim ring
- Contoured to match factory dash



95-5810



LINCOLN Town Car 2003-2011

- Designed specifically for the installation of Double-DIN radios



99-5810

LINCOLN Town Car 2003-2011

- Recessed DIN opening
- Metra's patented snap-in ISO Support System



95-5812



FORD | LINCOLN | MERCURY Multi-Kit
2004-2014**

- Designed specifically for the installation of Double-DIN radios



99-5812

FORD | LINCOLN | MERCURY Multi-Kit
2004-2015**

- Metra's patented quick release, snap-in ISO mount system with custom trim ring
- Recessed DIN opening



99-5813

**LINCOLN Navigator 2007-2014
MKX 2007-2010 | MKZ 2007-2009
Zephyr 2006**

- For models not equipped with navigation
- Metra's patented quick release snap-in ISO mounting system with ISO trim ring
- Recessed DIN opening



99-5814



**FORD Escape 2008-2012
MAZDA Tribute 2008-2011
MERCURY Mariner 2008-2011**

- Metra's patented quick release snap-in ISO mounting system with ISO trim ring
- Painted black to match OEM color and finish
- Includes parts for installation of one Double-DIN or two Single-DIN radios

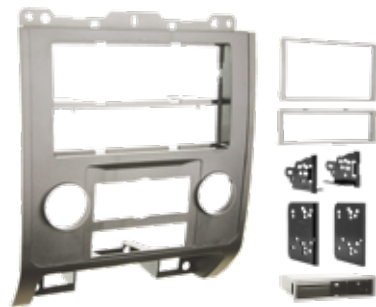

99-5814S



**FORD Escape 2008-2012
MAZDA Tribute 2008-2011
MERCURY Mariner 2008-2011**

- Metra's patented quick release snap-in ISO mounting system with ISO trim ring
- Painted silver to match OEM color and finish
- Also includes parts for installation of one Double-DIN or two Single-DIN radios



99-5816



FORD Focus 2008-2011

- Custom design allows retention of the factory air vents in their original location
- Metra's patented quick release snap-in ISO mounting system with ISO trim ring
- Contoured and painted silver to match factory dash



95-5817



FORD | LINCOLN | MERCURY | MAZDA

Multi-Kit** 1995-2011

- Designed specifically for the installation of Double-DIN radios or two Single-DIN radios
- High-grade ABS plastic - contoured and textured to compliment factory dash

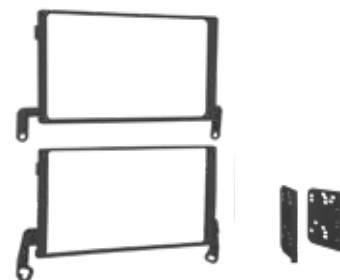

95-5818



FORD | LINCOLN Truck Multi-Kit**

F-150 | Expedition | Navigator
Blackwood 1997-2010

- High-grade ABS plastic - contoured and textured to compliment factory dash
- Painted to match OEM color and finish



95-5819



FORD F-150 2009-2014 (XL models with no options)

- High-grade ABS plastic, contoured and textured to compliment factory dash
- All necessary hardware to install an aftermarket radio



99-5819

FORD F-150 2009-2014 (XL models with no options)

- High-grade ABS plastic, contoured and textured to compliment factory dash
- All necessary hardware to install an aftermarket radio

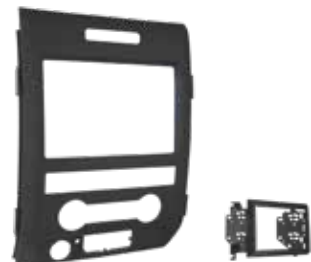

95-5820B



FORD F-150 2009-2014 (excluding base and NAV models & 2013-2014 models without color screen)

- All necessary hardware to install an aftermarket radio
- Painted matte black to match factory finish



99-5820B



FORD F-150 2009-2014 (excluding base and NAV models & 2013-2014 models without color screen)

- All necessary hardware to install an aftermarket radio
- Now painted matte black to match factory finish



95-5820CB



FORD F-150 King Ranch (without NAV) 2011-2012

- Cocobolo finish to match King Ranch models



99-5820CB



FORD F-150 King Ranch (without NAV) 2011-2012

- Cocobolo finish to match King Ranch models

FORD + LINCOLN + MERCURY

95-5820DW

FORD F-150 Lariat (excluding base and NAV models) **2011-2012**

- Drape Walnut finish to match Lariat models

99-5820DW

FORD F-150 Lariat (excluding base and NAV models) **2011-2012**

- Drape Walnut finish to match Lariat models

95-5820HG

FORD F-150 Select Models (without NAV) **2009-2012**

- Designed specifically for Double-DIN installations
- High gloss black finish in response to customer demand
- Perfect for 2011-12 Limited and FX models or an improvement to others from 2009-2012

99-5820HG

FORD F-150 Select Models (without NAV) **2009-2012**

- Pocket included for Single-DIN installations
- High gloss black finish in response to customer demand
- Perfect for 2011-12 Limited and FX models or an improvement to others from 2009-2012

95-5820SS

FORD F-150 Harley-Davidson **2011-2012**
(without NAV)

- Painted smoked satin to match factory Harley-Davidson Edition models

99-5820SS

FORD F-150 Harley-Davidson **2011-2012**
(without NAV)

- Painted smoked satin to match factory Harley-Davidson Edition models

99-5821B

FORD Fusion **2010-2012**
MERCURY Milan **2010-2011**

- For both DIN and Double-DIN
- Painted matte black to match dash

99-5821BL

FORD Fusion **2010-2012**
MERCURY Milan **2010-2011**

- For both DIN and Double-DIN
- Painted matte blue to match dash

99-5821R

FORD Fusion **2010-2012**
MERCURY Milan **2010-2011**

- For both DIN and Double-DIN
- Painted matte red to match dash



99-5821S



FORD **Fusion** 2010-2012
 MERCURY **Milan** 2010-2011
 • For both DIN and Double-DIN
 • Painted matte silver to match dash



95-5822B



FORD **F-150** (without NAV) 2009-2010
 • Double-DIN radio provision
 • Painted a scratch-resistant matte black
 • Specifically for non-NAV models that have the driver info switches in the factory panel



99-5822B



FORD **F-150** (without NAV) 2009-2010
 • Painted a scratch-resistant matte black
 • Specifically for non-NAV models that have the driver info switches in the factory panel



95-5822MM



FORD **F-150 Lariat** (without NAV) 2009-2010
 • Milano Maple



95-5822CM



FORD **F-150 King Ranch** (without NAV) 2009-2010
 • Curly Maple



99-5822MM



FORD **F-150 Lariat** (without NAV) 2009-2010
 • Milano Maple



95-5822CM



FORD **F-150 King Ranch** (without NAV) 2009-2010
 • Curly Maple



95-5822AS



F-150 **Platinum** (without NAV) 2009-2010
 • Ash Satin



99-5822AS



F-150 **Platinum** (without NAV) 2009-2010
 • Ash Satin

FORD



99-5824CH



FORD **Transit Connect** (without NAV) **2010-2012**
International Multi-Kit 2005-UP***

- For installation of Double-DIN and DIN radios
- Painted charcoal to match factory

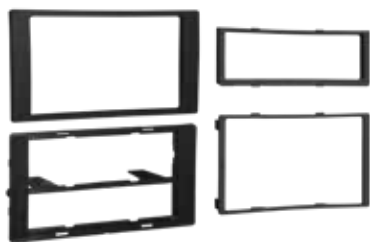

99-5824B



FORD **Transit Connect** (without NAV) **2010-2012**
International Multi-Kit 2005-UP***

- For installation of Double-DIN and DIN radios
- Painted matte black to match factory



99-5824S



FORD **Transit Connect** (without NAV) **2010-2012**
International Multi-Kit 2005-UP***

- For installation of Double-DIN and DIN radios
- Painted silver to match factory



Factory vents snap in and retain functions with control panel



99-5825B *Turbo*



FORD **Fiesta Kit 2011-2019** (models without MyFord Touch®)

- Designed for single ISO-DIN mount aftermarket radios
- Unique backlit, rubber buttons retain the factory hazard button, lock/unlock and controls of the driver information center
- Painted matte black to match factory finish



Factory vents snap in and retain functions with control panel



99-5825S *Turbo*



FORD **Fiesta Kit 2011-2019** (models without MyFord Touch®)

- Designed for single ISO-DIN mount aftermarket radios
- Unique backlit, rubber buttons retain the factory hazard button, lock/unlock and controls of the driver information center
- Painted silver to match factory finish

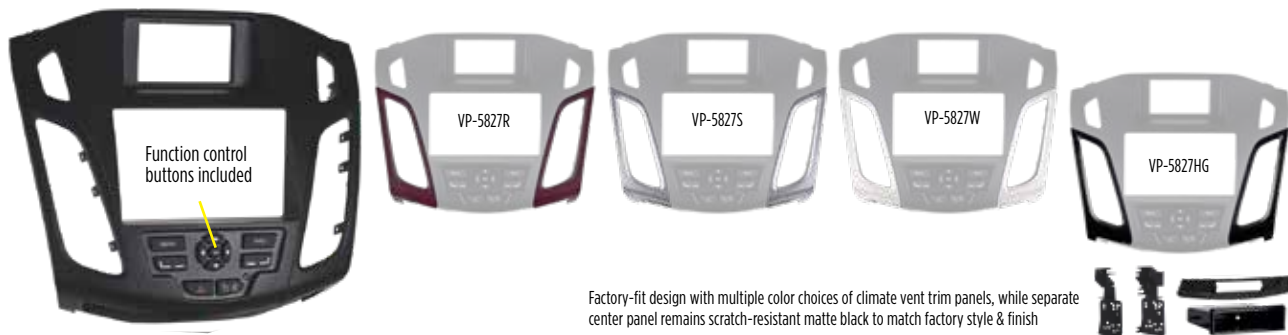

Factory-fit design with multiple color choices of climate vent trim panels, while separate center panel remains scratch-resistant matte black to match factory style & finish

99-5827B *Turbo*



FORD **Focus 2012-2014** (not for models equipped with MyFord Touch®)

- Designed for the installation of both DIN and Double-DIN aftermarket radios
- Unique backlit, rubber buttons retain the vehicle's hazard button, lock/unlock and controls of the Driver Information Center
- Center panel remains scratch-resistant matte black to match factory

VP-5827 Vent Trim Panels

- Sold in a variety of colors as accessories to the 99-5827B & 99-5843B

VP-5827R - Matte Red Vent Panels

VP-5827S - Silver Vent Panels

VP-5827W - White Vent Panels

VP-5827HG - High Gloss Black Vent Panels



99-5831B



FORD **Transit-Connect 2014-2018** (with factory 4.2" screen)

- Designed for installation of both ISO DIN and ISO Double-DIN radios
- Painted scratch-resistant matte black

- Retains factory display screen and switches
- Integrated passenger airbag indicator



99-5831G



FORD **Transit-Connect 2014-2018** (with factory 4.2" screen)

- Designed for installation of both ISO DIN and ISO Double-DIN radios
- Painted gray and black two-tone to match the factory appearance

- Retains factory display screen and switches
- Integrated passenger airbag indicator

FORD



Provisions to retain the factory hazard switch and passenger airbag indicator

99-5832G



FORD **Transit 2015-2019** (with AM/FM only radio)

- Designed for the installation of DIN or Double-DIN radios
- Replacement panel at the top of the dash provides room for Double-DIN without compromising the factory dash
- Provisions to retain the factory hazard switch and passenger airbag indicator



Integrated with a hazard button and passenger airbag indicator

99-5833B



FORD **Escape 2013-2018** (with factory 4.2" screen)

Escape S-Trim 2019-UP*

- Designed for the installation of DIN or Double-DIN radios
- Integrated with a hazard button and passenger airbag indicator
- Radio bracket design allows for minimal sub dash modification



All trim level factory switches retained

Passenger airbag indicator icon included

99-5834CH



FORD **F-150** (excluding 2018-up models with 8" touchscreen SYNC radio) **2015-UP***

- Designed for ISO DIN with pocket and ISO Double-DIN radio provision
- Painted charcoal to match the factory finish
- Touchscreen display for climate and personalization features
- Built-in AXSWC technology retains factory steering wheel controls



Includes an airbag light blank panel for models without a passenger airbag indicator

99-5835G



FORD **Transit 2015-2019** (without NAV, with AM/FM/CD radio)

- ISO DIN radio provision with pocket
- ISO Double-DIN radio provision
- Complete radio panel for a factory look
- Includes an airbag light blank panel for models without a passenger airbag indicator
- Radio trim panel is painted gray to match the factory finish

Two included trim panels allow the aftermarket radio to be mounted in top or bottom locations

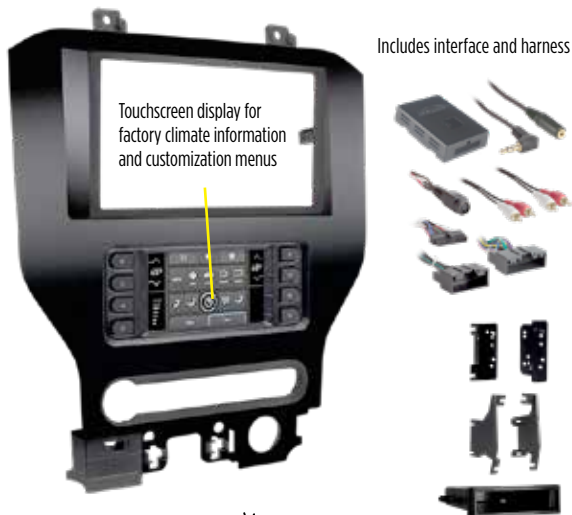

99-5838CH *TurboTouch* **P D**

- FORD Mustang 2015-UP*** (with factory 4.2" screen)
- Designed for ISO DIN with pocket and ISO Double-DIN radio provision
 - Touchscreen display for factory climate information and driver customization menus
 - Built-in AXSWC technology retains most factory steering wheel controls
 - Painted charcoal to match factory finish
 - Axxess interface and harness included
 - Antenna adapter included for a complete installation



99-5839CH *TurboTouch* **P D**

- FORD Mustang 2010-2014**
- Designed for ISO DIN with pocket and ISO Double-DIN radio provision
 - Touchscreen display for factory climate information and driver customization menus
 - Painted charcoal to match factory finish
 - Axxess interface and harness included
 - Antenna adapter included for a complete installation



99-5840CH *TurboTouch* **P D**

- FORD Mustang 2015-UP*** (With factory 8" screen)
- Designed for ISO DIN with pocket and ISO Double-DIN radio provision
 - Touchscreen display for factory climate information and customization menus
 - Built-in AXSWC technology retains factory steering wheel controls
 - Painted charcoal to match factory finish
 - Axxess interface and harness included
 - Antenna adapter included for a complete installation



99-5841B *TurboTouch* **P D**

- FORD Fusion 2013-2017**
- Designed for ISO DIN with pocket and ISO Double-DIN radio provision
 - Touchscreen display for factory climate information and customization menus
 - Painted black to match factory finish
 - Axxess interface and harness included
 - Antenna adapter included for a complete installation

Manufactured under one or more of the following U.S. Patents and pending applications: #D831021

FORD



Integrated 4.3 inch touchscreen and user interface provide factory HVAC control and personalization setting controls

99-5842B



FORD Flex 2008-2012

- Integrated 4.3 inch touchscreen and user interface provide factory HVAC control and personalization setting controls
- Built-in AXSWC technology retains most factory steering wheel control functionality
- Smart interface technology automatically detects the vehicle and the vehicle's features
- Retention of factory safety features including backup cameras and sensors as well as vehicle information
- Also available in tan (99-5842T)



Integrated 4.3 inch touchscreen and user interface provide factory HVAC control and personalization setting controls

99-5842T



FORD Flex 2008-2012

- Integrated 4.3 inch touchscreen and user interface provide factory HVAC control and personalization setting controls
- Built-in AXSWC technology retains most factory steering wheel control functionality
- Smart interface technology automatically detects the vehicle and the vehicle's features
- Retention of factory safety features including backup cameras and sensors as well as vehicle information
- Also available in black (99-5842B)



Function control buttons included

99-5843B



FORD Focus 2015-2018 (with factory 4.2" screen)

- Designed for the installation of both Single-DIN and Double-DIN radios
- Includes Axxess interface and wiring
- Painted scratch-resistant matte black

VP-5827 Vent Trim Panels

- Sold in a variety of colors as accessories to the 99-5843B

VP-5827R - Matte Red Vent Panels

VP-5827S - Silver Vent Panels

VP-5827W - White Vent Panels

VP-5827HG - High Gloss Black Vent Panels



95-5844S | 95-5845S



LINCOLN Navigator 2007-2014 (4X2 models without NAV)

- Designed specifically for the installation of Double-DIN radios
- Painted silver to match the factory finish



99-5846B



FORD F-150 2013-2014 (with factory 4.2" screen)

- Integrated 4.3" touchscreen and buttons retain and control most climate and vehicle customization functions normally lost when removing factory radio
- Patent pending touchscreen design also retains the factory safety features including the backup camera
- Retains steering wheel functionality - no need to purchase and install a separate steering wheel control interface!
- 8 backlit buttons with over 250 customizable color options
- Parts included for installation of Single-DIN and Double-DIN radios
- Allows for installation of the radio or touchscreen in upper or lower kit area
- Integrated hazard button and passenger airbag indicator
- Painted to match the factory finish



Integrated 4.3" touchscreen and buttons retain and control most climate and vehicle customization functions normally lost when removing factory radio

99-5847CH



FORD Explorer 2011-2015 (with factory 4.2" screen)

- Integrated 4.3" touchscreen and buttons retain and control most climate and vehicle customization functions normally lost when removing factory radio
- Patent pending touchscreen design also retains the factory safety features including the backup camera
- Integrated hazard button and passenger airbag indicator
- Retains steering wheel functionality - no need to purchase and install a separate steering wheel control interface!
- 8 backlit buttons with over 250 customizable color options
- Parts included for installation of Single-DIN and Double-DIN radios
- Painted to match the factory finish



Integrated 4.3" touchscreen and buttons retain and control most climate and vehicle customization functions normally lost when removing factory radio

99-5848CH



FORD Edge 2011-2014 (with 4.2" screen, excluding SEL trim)

- Integrated 4.3" touchscreen and buttons retain and control most climate and vehicle customization functions normally lost when removing factory radio
- Patent pending touchscreen design also retains the factory safety features including the backup camera
- Retains steering wheel functionality - no need to purchase and install a separate steering wheel control interface!
- 8 backlit buttons with over 250 customizable color options
- Parts included for installation of Single-DIN and Double-DIN radios
- Integrated hazard button and passenger airbag indicator
- Painted to match the factory finish



Factory style hard buttons with laser etched graphics to retain and control most climate functions normally lost when removing factory radio

99-5849CH



FORD F-150* 2015-2017 250/350/450 XL (with CD) XLT 2017

(with single-zone, manual climate controls)

- Factory-style hard buttons with laser etched graphics to retain and control most climate functions normally lost when removing factory radio
- Easy to use rotary knobs with LCD status displays for temp and fan speed
- Retains steering wheel functionality - no need to purchase and install a separate steering wheel control interface!
- Parts included for installation of Single-DIN and Double-DIN radios
- Integrated hazard button and passenger airbag indicator
- Painted to match the factory finish

FORD



95-5850B



FORD F-250 | 350 | 450 | 550 **2017-UP*** (without 4.2" color screen, XL models not equipped with CD player)

- Designed specifically for the installation of double-DIN radios
- Painted matte black to match the factory color and finish



99-5850B



FORD F-250 | 350 | 450 | 550 **2017-UP*** (without 4.2" color screen, XL models not equipped with CD player)

- Includes parts for the installation of Single-DIN radios
- Painted matte black to match the factory color and finish



Integrated 4.3" touchscreen and buttons retain and control most climate and vehicle customization functions normally lost when removing factory radio

99-5851CH



FORD **Edge 2015-2017 | Edge 2018-UP*** (without amp)

- Integrated 4.3" touchscreen and buttons retain and control most climate and vehicle customization functions normally lost when removing factory radio
- Patent pending touchscreen design also retains the factory safety features including the backup camera
- 8 backlit buttons with over 250 customizable color options
- Parts included for installation of Single-DIN and Double-DIN radios
- Retains steering wheel functionality - no need to purchase and install a separate steering wheel control interface!
- Unique design with multiple panels allows for installation of the radio or touch screen in upper or lower area of the kit
- Painted to match the factory finish
- Integrated hazard button and passenger airbag indicator



Retains and controls most climate functions normally lost when removing factory radio

Rotary knobs with LCD status displays

Painted to match the factory finish

99-5852CH



FORD **Explorer 2011-2015** (with single-zone climate controls)

- Factory-style hard buttons with laser etched graphics to retain and control most climate functions normally lost when removing factory radio
- Easy to use rotary knobs with LCD status display for temp and fan speed
- Parts included for installation of Single-DIN and Double-DIN radios
- Retains steering wheel functionality - no need to purchase and install a separate steering wheel control interface!
- Integrated hazard button and passenger airbag indicator
- Painted to match the factory finish



95-5853CH



- FORD Mustang 2010-2014** (with single-zone climate controls)
- Factory-style hard buttons with laser etched graphics to retain and control most climate functions normally lost when removing factory radio
 - Easy to use rotary knobs with LCD status display for temp and fan speed
 - Parts included for installation of Single-DIN and Double-DIN radios
 - Retains steering wheel functionality - no need to purchase and install a separate steering wheel control interface!
 - Integrated hazard button and passenger airbag indicator
 - Painted to match the factory finish



99-5854B



- FORD Fusion 2015-2019** (with single-zone climate controls)
- Factory-style hard buttons with laser etched graphics to retain and control most climate functions normally lost when removing factory radio
 - Easy to use rotary knobs with LCD status display for temp and fan speed
 - Parts included for installation of Single-DIN and Double-DIN radios
 - Retains steering wheel functionality - no need to purchase and install a separate steering wheel control interface!
 - Integrated hazard button and passenger airbag indicator
 - Painted to match the factory finish



99-5855CH



- FORD Edge 2011-2014** (with single-zone climate controls)
- Factory style hard buttons with laser etched graphics to retain and control most climate functions normally lost when removing factory radio
 - Easy to use rotary knobs with LCD status display for temp and fan speed
 - Parts included for installation of Single-DIN and Double-DIN radios
 - Retains steering wheel functionality - no need to purchase and install a separate steering wheel control interface!
 - Integrated hazard button and passenger airbag indicator
 - Painted to match the factory finish



99-5856B



- FORD Transit 2014-2018** (with no factory display)
- Parts included for both ISO Single-DIN (with pocket) and ISO Double-DIN installations
 - Painted scratch-resistant matte black to match the factory finish
 - Includes passenger airbag indicator

FORD

**99-5857B**

FORD Ranger 2019-UP* (with factory 4.2" screen)

- Parts included for both ISO Single-DIN and ISO Double-DIN installations
- Includes parts that allow the retention of the factory climate control panel, passenger airbag indicator and hazard button
- Painted scratch-resistant matte black to match the factory appearance



Touchscreen display for climate, audio interfacing and personalization features

99-5858CH

FORD Explorer 2011-2015 (with factory 8" screen)

- Parts included for both ISO Single-DIN and ISO Double-DIN installations
- Touchscreen display for climate, audio interfacing and personalization features
- Included interface for climate and steering wheel functions
- Painted charcoal to match the factory finish

**DP-5859**

FORD Full Size Trucks and SUVs 1997-2004

- Select Ford F-Series, Expedition, and Navigator
- Custom textured replacement dash panel to accommodate Double-DIN radios
- Multiple trim panels and brackets to cover multiple trim levels and vehicle options

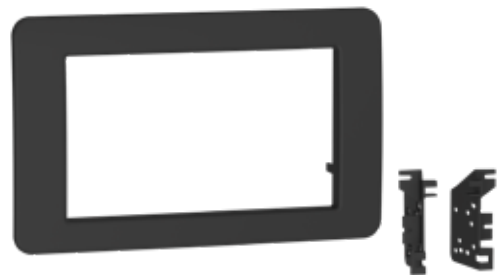
**95-5860**

FORD E Series Cutaway 2021

- Textured trim panel designed to cover minor dash modifications
- Double-DIN brackets provide stable mounting points

Metra®

THE INSTALLER'S CHOICE

AT YOUR FINGERTIPS

SUBSCRIBE TODAY!

- New Products
- Instruction Videos
- Interviews with industry professionals

GENERAL MOTORS



95-2001



GM | BUICK | CADILLAC | CHEVROLET | GMC
OLDSMOBILE | PONTIAC | ISUZU **Multi-Kit****

1994-2012 (oversize GM radio)

- Designed specifically for the installation of Double-DIN radios



99-2001

GM | BUICK | CADILLAC | CHEVROLET | GMC
OLDSMOBILE | PONTIAC | ISUZU **Multi-Kit****

1994-2012 (oversize GM radio)

- Pocket included for Single-DIN installations
- See Multi-Kit guide or Application Chart of this catalog for applications



99-2002

CADILLAC **Eldorado** | **Seville** **1992-1995**
(console shift only)

- Designed for DIN mount radios
- Does not fit floor shift models



99-2003



GM **Multi-Kit**** **1990-2012**

- Provides pocket with recessed mounting an ISO Single-DIN radio using Metra patented ISO quick release brackets
- DIN head unit provisions with pocket
- ISO Single-DIN head unit provisions with pocket
- Double-DIN head unit provision

Manufactured under one or more of the following U.S. Patents and pending applications: #D505672



95-2004



CADILLAC **DeVille** **1996-1999** | **Catera**
1997-2001 (column shift only)

- Designed specifically for the installation of Double-DIN radios

Manufactured under one or more of the following U.S. Patents and pending applications: #D639287



99-2004

CADILLAC **DeVille** **1996-1999** | **Catera**
1997-2001 (column shift only)

- Recessed DIN radio opening
- ISO mount radio compatible using snap-in ISO radio mounts



95-2005B



CADILLAC **Eldorado** **1996-2002**
Seville **1996-2004** | **DeVille** **2000-2005**
DeVille Concours **1996-1999**
(console shift only)

- Designed specifically for the installation of Double-DIN radios
- Painted matte black



99-2005

CADILLAC **Eldorado** **1996-2002**
Seville **1996-2004** | **DeVille** **2000-2005**
DeVille Concours **1996-1999** (console shift only)

- Metra's patented quick release snap-in ISO mounting system with ISO trim ring
- Oversized under-radio pocket
- Recessed DIN mount

Manufactured under one or more of the following U.S. Patents and pending applications: #D517061



99-2006



CADILLAC **CTS** **2003-2007** | **SRX** **2004-2006**

- Interchangeable design allows recessed DIN opening to be above or below the pocket
- Metra's patented quick release snap-in ISO mounting system with ISO trim ring
- Painted matte black to match OEM color and finish
- Designed for Single-DIN and Double-DIN installations



99-2006G



CADILLAC CTS 2003-2007 | SRX 2004-2006

- Painted to match gray OEM color and finish
- Same features as 99-2006



99-2007



CADILLAC Escalade 2007-2014

- (including ESV & EXT)
- Large trim panel and ISO mounting system provide space in dash where depth is limited
 - Removable oversized storage pocket
 - Includes parts for installation of Double-DIN radios
 - Painted matte black to match factory finish



99-2008



CADILLAC DTS 2006-2011 | SRX 2007-2009

- Metra's patented quick release snap-in ISO mounting system with ISO trim ring
- Includes parts for installation of Double-DIN radios
- Painted charcoal to match OEM color and finish

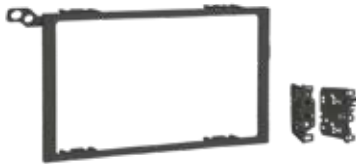

95-2009



GM | SUZUKI Multi-Kit** 1990-2012

- Metra's patented quick release snap-in ISO mounting system with ISO trim ring
- Allows the installation of a Double-DIN radio or two Single-DIN radios



99-2009

GM | SUZUKI Multi-Kit** 1990-2012

- Provides pocket with recessed mounting of a Single-DIN radio or an ISO Single-DIN radio using Metra's patented ISO quick release brackets



99-2010



CADILLAC STS 2005-2011

- Metra's patented quick release snap-in ISO mounting system with ISO trim ring
- Also includes parts for installation of a Double-DIN radio
- Painted matte black to match OEM color and finish



99-2011



GM Multi-Kit** 1992-2004

- This design of the most popular GM multi-kit combines Single-DIN and Double-DIN provisions into one kit
- Double-DIN opening is revised for newer aftermarket radios



99-2020

BUICK Regal 1988-1994

- Professional Installer Series TurboKit suited to aftermarket applications
- Quick conversion from 2-shaft to DIN
- Also available: GM radio replacement pocket to use when removing OEM radio and installing radio in center dash part number 88-00-2020, and 70-1855 tuner bypass harness



88-00-2020

BUICK Regal Cassette Pocket 1988-1994

- OEM radio replacement pocket
- Includes ribs to hold cassette boxes
- For a complete installation combine with 99-2020

GENERAL MOTORS



99-2021



BUICK Lacrosse 2005-2009

- Metra's patented quick release snap-in ISO mounting system with ISO trim ring
- Includes parts for installing a Double-DIN radio



No cutting of dash

99-2022B Turbo



BUICK Regal 2011-2012 (for models without push button start and monochrome display screen)

- Painted scratch-resistant matte black to match the factory color and finish
- Parts included to relocate the climate controls, allowing for Double-DIN without dash modifications
- Included interface retains factory Driver Information Center screen



No cutting of dash

99-2022BR Turbo



BUICK Regal 2011-2012 (for models without push button start and monochrome display screen)

- Painted scratch-resistant matte brown to match the factory color and finish
- Parts included to relocate the climate controls, allowing for Double-DIN without dash modifications
- Included interface retains factory Driver Information Center screen



No cutting of dash

99-2023B Turbo



BUICK Regal 2011-2012 (for models with push button start and monochrome display screen)

- Painted scratch-resistant matte black to match the factory color and finish
- Relocate the climate controls, allowing for Double-DIN without dash modifications
- Included interface retains factory Driver Information Center screen
- Designed with mounting location for push button start



No cutting of dash

99-2023BR Turbo



BUICK Regal 2011-2012 (for models with push button start and monochrome display screen)

- Painted scratch-resistant matte brown to match the factory color and finish
- Relocate the climate controls, allowing for Double-DIN without dash modifications
- Included interface retains factory Driver Information Center screen
- Designed with mounting location for push button start



95-3000



GM Trucks & SUVs 1988-1994

- Specifically designed for Double-DIN installations
- Multiple textures combined to match factory appearance
- For GM full size trucks and SUVs
- Also available, replacement pocket 88-00-3301 and harness with antenna adapter 70-1855



99-3000

CHEVROLET | GMC Full Size Truck 1988-1994

- Automotive-grade ABS plastic provides factory finish
- Utilizes factory air vents and clips
- Snap-in quick release ISO mount brackets
- Also available, replacement pocket 88-00-3301 and harness with antenna adapter 70-1855



99-3000B



CHEVROLET | GMC Full Size Truck 1988-1994

- Automotive-grade ABS plastic provides factory finish
- Utilizes factory air vents and clips
- Snap-in quick release ISO mount brackets
- Painted to match blue OEM color and finish
- Also available, replacement pocket 88-00-3301 and harness with antenna adapter 70-1855



99-3000G



CHEVROLET | GMC Full Size Truck 1988-1994

- Automotive-grade ABS plastic provides factory finish
- Utilizes factory air vents and clips
- Snap-in quick release ISO mount brackets
- Painted to match gray OEM color and finish
- Also available, replacement pocket 88-00-3301 and harness with antenna adapter 70-1855



99-3000R



CHEVROLET | GMC Full Size Truck 1988-1994

- Automotive-grade ABS plastic provides factory finish
- Utilizes factory air vents and clips
- Snap-in quick release ISO mount brackets
- Painted to match red OEM color and finish
- Also available, replacement pocket 88-00-3301 and harness with antenna adapter 70-1855



99-3000BG



CHEVROLET | GMC Full Size Truck 1988-1994

- Automotive-grade ABS plastic provides factory finish
- Utilizes factory air vents and clips
- Snap-in quick release ISO mount brackets
- Painted to match beige OEM color and finish
- Also available, replacement pocket 88-00-3301 and harness with antenna adapter 70-1855



99-3000BR



CHEVROLET | GMC Full Size Truck 1988-1994

- Automotive-grade ABS plastic provides factory finish
- Utilizes factory air vents and clips
- Snap-in quick release ISO mount brackets
- Painted to match brown OEM color and finish
- Also available, replacement pocket 88-00-3301 and harness with antenna adapter 70-1855



Double-DIN radio opening without cutting the factory panel!



DP-3002GY

• Gray



DP-3002SHL

• Shale



DP-3002PWT

• Pewter



DP-3002TB

• Black

DP-3002B



GM Trucks 1999-2002

- Large panel replaces the factory dash panel and provides the space for a modern Double-DIN radio
- No custom fabrication work is required
- Painted scratch-resistant matte black and offered in multiple other colors



88-00-3301

CHEVROLET | GMC Full Size Truck Pocket 1988-1994

- OEM radio replacement pocket
- Includes ribs to hold CD jewel cases
- To be used with 95-3000, 99-3000 or 99-3001

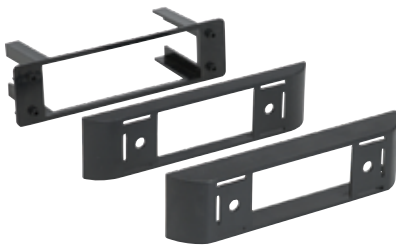

99-3001

CHEVROLET | GMC Full Size Truck 1988-1994

- To be used with factory dash panel
- Fits over factory pocket
- Factory pocket must be removed for installation
- Also available, replacement pocket 88-00-3301 and harness with antenna adapter 70-1855



99-3002

CADILLAC | CHEVROLET | GMC Truck Multi-Kit** 1995-2005

- Includes a recessed DIN opening
- Specially designed for ISO mount radio with ISO trim ring



GENERAL MOTORS



DP-3003 D

GM Truck | SUV 1995-2002

- Large panel replaces the factory dash panel and provides the space for a modern Double-DIN radio
- No custom fabrication work is required
- Two custom textures provide a factory look and feel



95-3003G P T D

GM Truck | SUV 1995-2002

- A cover trim plate for fitting Double-DIN into the factory dash panel
- Cutting of the factory dash is required
- Textured and painted to match the factory finish

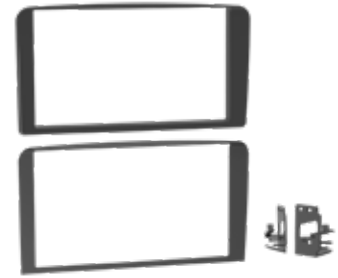

95-3004 P T D

CADILLAC Escalade 2002

- A cover trim plate for fitting Double-DIN into the factory dash panel
- Cutting of the factory dash is required
- Textured and painted to match the factory finish

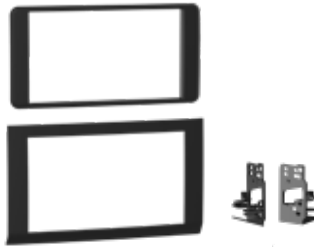

95-3005 D

CHEVROLET Astro 1996-2005
GMC Safari 1996-2005

- Double-DIN specific mounting solution
- Custom textured to match the factory appearance
- Cutting template included to simplify modifying the factory dash panel



95-3009 D

CHEVROLET Camaro 1993-1996
PONTIAC Firebird 1993-2002

- Designed specifically for the installation of Double-DIN radios
- Minor sub-dash modifications with detailed directions for an easy install
- Replacement panel with factory matched texture creates the space for Double-DIN



99-3009

CHEVROLET Camaro 1993-1996
PONTIAC Firebird 1993-2002

- Recessed for DIN applications
- Fills in gap on right side opening



Manufactured under one or more of the following U.S. Patents and pending applications: #D904390



99-3010S-LC *Turbo* P D

CHEVROLET Camaro 2010-2015

- For installation of Single-DIN or Double-DIN radios
- The large sweeping panel is designed with a factory look and painted silver to match the OEM finish
- The blue LED illuminated climate control display and soft touch buttons are designed to retain full functionality of the Camaro's climate system
- The kit's control layout also retains heated seats, hazard lights and lock and unlock controls
- Includes an "essentials only" interface to supply data to the Metra-built climate controls, supply switched ignition accessory R.A.P. to the aftermarket radio and retain all vehicle warning chimes (including backup sensor chimes)
- All software is flash updateable to adapt to changes

Essentials only interface included for the budget install



99-3010S *Turbo* P D

CHEVROLET Camaro 2010-2015

- Designed for installation of Single-DIN or Double-DIN radios
- Designed with a factory look and painted silver to match the OEM finish
- The blue LED illuminated climate control display and soft touch buttons are designed to retain full functionality of the Camaro's climate system
- The kit's control layout also retains heated seats, hazard lights and lock and unlock controls
- The included interface will also retain all audio and Onstar system functions
- All software is flash updateable to adapt to changes



Manufactured under one or more of the following U.S. Patents and pending applications: #D639794



99-3011S



CHEVROLET **Cruze 2011-2015**
Cruze Limited 2016

- Parts included for DIN and Double-DIN installations
- Painted silver to match the factory finish
- Retains functions of factory air vents
- To retain the OEM display, use GMOS-044 for monochrome displays, GMOS-045 for color displays



99-3012G Turbo



CHEVROLET **Sonic 2012-2016**

- For installation of DIN and Double-DIN radios
- Interface included retains ONSTAR, all warning chimes, factory Bluetooth® and factory personalization with an optional LCD



99-3012G-LC Turbo



CHEVROLET **Sonic 2012-2016**

- For installation of DIN and Double-DIN radios
- Includes an “essentials only” interface to supply switched ignition accessory R.A.P. to the aftermarket radio and retain all vehicles warning chimes (including backup sensor chimes)



99-3014G



CHEVROLET **Silverado | GMC Sierra 2014-2019**

- Parts included for installation of DIN and Double-DIN radios
- Painted gunmetal metallic to match the factory color and finish



99-3015G



CHEVROLET **Tahoe | Suburban**
GMC Yukon 2015-UP*

- Designed for the installation of Single-DIN and Double-DIN radios
- Painted to match the factory color and finish



95-3016G



CHEVROLET **Colorado | GMC Canyon 2015-UP***

- Specifically designed for Double-DIN installations
- Painted to match the factory color and finish
- Custom design retains the factory climate controls in their original location

Manufactured under one or more of the following U.S. Patents and pending applications: #D756988

Manufactured under one or more of the following U.S. Patents and pending applications: #D789349

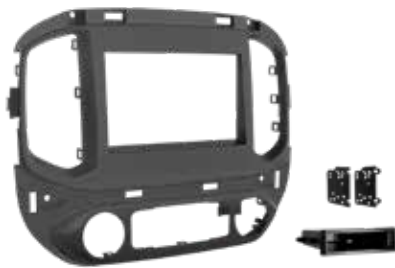

99-3016G



CHEVROLET **Colorado | GMC Canyon 2015-UP***

- Pocket is included for Single-DIN installations
- Painted to match the factory color and finish
- Custom design retains the factory climate controls in their original location

Manufactured under one or more of the following U.S. Patents and pending applications: #D789349



99-3017B



CHEVROLET **Trax 2015-2016**

- Designed specifically for Double-DIN installations
- Painted scratch-resistant matte black to match the factory color and finish
- Custom design retains the factory climate vents in their original location



95-3017B



CHEVROLET **Trax 2015-2016**

- Pocket is included for Single-DIN installations
- Painted scratch-resistant matte black
- Retains the factory climate vents in their original location

Manufactured under one or more of the following U.S. Patents and pending applications: #D807871

GENERAL MOTORS



99-3018HG



CADILLAC CTS 2008-2014

- Designed for both Single-DIN and Double-DIN installations
- Painted gloss black to match factory color and appearance
- Included interface retains all factory climate control functions
- Parts included to cover both NAV and non-NAV equipped vehicles



Manufactured under one or more of the following U.S. Patents and pending applications #D835018



99-3018S



CADILLAC CTS 2008-2014

- Designed for both Single-DIN and Double-DIN installations
- Painted silver to match the factory color and appearance
- An included interface retains all factory climate control functions
- Parts included to cover both NAV and non-NAV equipped vehicles



95-3019B



CHEVROLET **Malibu 2016-UP***

- Specifically designed for Double-DIN installations
- Painted scratch-resistant matte black
- Built with a sub-bracket for a solid mount to the vehicle



99-3019B



CHEVROLET **Malibu 2016-UP***

- Pocket included for Single-DIN installations
- Painted scratch-resistant matte black
- Built with a sub-bracket for a solid mount to the vehicle



95-3020HG



CHEVROLET **Cruze | Cruze Hatchback 2016-2019**

- Specifically designed for Double-DIN installations
- Painted high gloss black



99-3020HG



CHEVROLET **Cruze | Cruze Hatchback 2016-2019**

- Pocket included for Single-DIN installations
- Painted high gloss black



95-3020B



CHEVROLET **Cruze | Cruze Hatchback 2016-2019**

- Specifically designed for Double-DIN installations
- Painted scratch-resistant matte black



99-3020B



CHEVROLET **Cruze | Cruze Hatchback 2016-2019**

- Pocket included for Single-DIN installations
- Painted scratch-resistant matte black



DP-3021B



CHEVROLET **Corvette 1997-2004**

- A large kit that replaces the factory dash panel to accommodate Double-DIN installations
- No custom work or cutting of the factory bezel required
- Painted scratch-resistant matte black



95-3022B



CHEVROLET **Equinox 2018-UP***

- Specifically designed for Double-DIN installations
- Painted scratch-resistant matte black to match the factory finish



99-3022B



CHEVROLET **Equinox 2018-UP***

- Includes a pocket for Single-DIN installations
- Painted scratch-resistant matte black to match the factory finish

GENERAL MOTORS

**95-3023HG****CHEVROLET Trax 2017-UP***

- Designed for the installation of Double-DIN radios
- Painted gloss black to match the factory color and finish

**99-3023HG****CHEVROLET Trax 2017-UP***

- Includes parts for the installation of Single-DIN radios
- Painted gloss black to match the factory color and finish

**99-3024B****CHEVROLET Impala 2014-2020**

- Parts included for the installation of both Single-DIN and Double-DIN radios
- Painted scratch-resistant matte black to match the factory finish

**95-3025B****BUICK Encore 2013-2016**

- Specifically designed for Double-DIN installations
- Painted to match the factory finish

**95-3027****GM Small Trucks & SUVs 1998-2002**

- ISO Double-DIN radio provision
- Designed specifically for the installation of Double-DIN radios
- Includes a contoured Double-DIN trim for a clean factory look

**99-3028S****CHEVROLET Camaro 2010-2015**

- Parts included for both ISO Single-DIN (with pocket) and ISO Double-DIN installations
- Painted silver to match the factory finish
- Retains the factory climate knobs for a factory look and feel
- Includes an Axxess interface, wiring harness, and antenna adapter

**99-3030B****CADILLAC XLR 2004-2009**

- Parts included for both ISO Single-DIN (with pocket) and ISO Double-DIN installations
- Complete center dash panel painted matte black for a factory look
- Includes an Axxess interface, wiring harness, AXSWC, and antenna adapter for a complete installation

**95-3031B****GM CAPTIVA SPORT 2014-2015 (with NAV)**

- ISO Double-DIN radio provision
- Painted scratch-resistant matte black to match the factory finish

**99-3031B****GM CAPTIVA SPORT 2014-2015 (with NAV)**

- ISO Single-DIN radio provision with pocket
- Painted scratch-resistant matte black to match the factory finish



99-3033

CHEVROLET **Impala** | **Caprice** 1985-1990

- Replaces 99-3032
- Metra's patented Snap-In ISO Support System
- Recessed Single-DIN mount



99-3042

CHEVROLET **S-10 and S-15 Pickup** 1986-1993

CHEVROLET **Blazer** | GMC **Jimmy** 1986-1994

CHEVROLET **Camaro** 1982-1992

SATURN **All Models** 1991-1994

PONTIAC **Firebird** 1982-1992

- Single-DIN head unit provision
- Attractive 1" rounded extension



Quick access to Metra's parts, specs, products info and more!

Download it **FREE**



99-3043

CHEVROLET **S-10 and T-10 Pickup** 1994-1997

CHEVROLET **Blazer** | GMC **Jimmy** 1995-1997

ISUZU **Hombre** 1996-1997

OLDSMOBILE **Bravada** 1996-1997

- Specially designed for ISO mount radio with ISO trim ring
- Unique design retains factory pocket and adds strength to kit



99-3043G

CHEVROLET **S-10 and T-10 Pickup** 1994-1997

GMC **Sonoma** 1994-1997

CHEVROLET **Blazer** | GMC **Jimmy** 1995-1997

ISUZU **Hombre** 1996-1997

OLDSMOBILE **Bravada** 1996-1997

- Painted to match factory gray finish
- Same features as 99-3043



99-3045

CHEVROLET **S-10 and T-10 Pickup** 1994-1997

GMC **Sonoma** 1994-1997

CHEVROLET **Blazer** | GMC **Jimmy** 1995-1997

ISUZU **Hombre** 1996-1997

OLDSMOBILE **Bravada** 1996-1997

- Now designed for installation of Single-DIN and Double-DIN aftermarket radios
- Large storage pocket for Single-DIN installations



99-3045G

CHEVROLET **S-10 and T-10 Pickup** 1994-1997

GMC **Sonoma** 1994-1997

CHEVROLET **Blazer** | GMC **Jimmy** 1995-1997

ISUZU **Hombre** 1996-1997

OLDSMOBILE **Bravada** 1996-1997

- Now designed for installation of Single-DIN and Double-DIN aftermarket radios
- Large storage pocket for Single-DIN installations
- Painted to match factory gray color and finish



99-3051

CHEVROLET **Corvette** 1990-1996

- Mounts an ISO mount radio with included pocket
- Accepts a Double-DIN radio also



87-99-3052

CHEVROLET | GMC **Truck** 1973-1991

- 2-shaft or Single-DIN
- Adds structural support to dash when installing a Single-DIN radio

GENERAL MOTORS



99-3100

SATURN All Models 1995-1999

- Includes a recessed Single-DIN Opening
- Rear support legs provide added stability



95-3105

SATURN All Models 1995-1999

- Double-DIN radio provision



99-3105

SATURN All Models 1995-1999

- Pocket holds two CD jewel cases
- Designed for Single-DIN mount radios
- Easy-to-use instructions



95-3107G



SATURN Astra 2008-2009

- Designed specifically for the installation of Double-DIN radios
- Painted to match gray OEM color and finish



99-3107G



SATURN Astra 2008-2009

- Metra's patented quick release snap-in ISO mounting system with ISO trim ring
- Recessed Single-DIN opening
- Painted to match gray OEM color and finish



95-3107S



SATURN Astra 2008-2009

- Designed specifically for the installation of Double-DIN radios
- Painted to match silver OEM color and finish



99-3107S



SATURN Astra 2008-2009

- Metra's patented quick release snap-in ISO mounting system with ISO trim ring
- Recessed Single-DIN opening
- Painted to match silver OEM color and finish



99-3108



SATURN Multi-Kit** 2000-2005

- Designed for installation of Single-DIN and Double-DIN aftermarket radios
- Double-DIN opening is revised for newer aftermarket radios
- See Multi-Kit guide of this catalog for applications



99-3300

CHEVROLET | OLDSMOBILE | PONTIAC Multi-Kit** 1994-2004

- See Multi-Kit guide or Application Chart of this catalog for applications



99-3301

GM Multi-Kit** 1995-2012

- Specially designed for ISO mount radios
- Pocket holds two CD jewel cases
- See Multi-Kit guide of this catalog for applications



88-00-3302

GM Truck & SUV Replacement Pocket 1995-2001

- Equipped from the factory, 1995-2001 GM trucks and SUVs have a cassette player or single CD player located separately from the factory radio
- For a complete installation, combine with 99-3002 dash kit

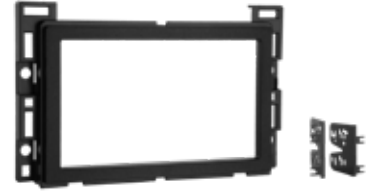

95-3302



CHEVROLET Multi-Kit** 2005-2012

- Designed specifically for the installation of Double-DIN radios
- Painted black to match OEM finish
- See Multi-Kit guide of this catalog for applications

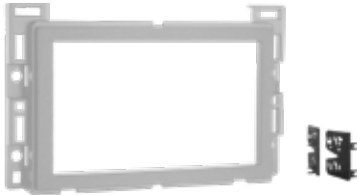

95-3302S



CHEVROLET Multi-Kit** 2005-2012

- Designed specifically for the installation of Double-DIN radios
- Painted silver to match OEM finish
- See Multi-Kit guide of this catalog for applications



99-3302



GM Multi-Kit** 2005-2012

- Designed for Single-DIN installations with pocket
- Painted black to match OEM finish
- See Multi-Kit guide of this catalog for applications



99-3302S



CHEVROLET Multi-Kit** 2005-2012

- Designed for Single-DIN installations with pocket
- Painted silver to match OEM finish
- See Multi-Kit guide of this catalog for applications

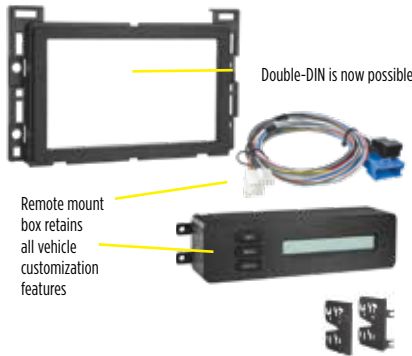

95-3303B Turbo



CHEVROLET Malibu | Cobalt | PONTIAC G6 2004-2008

- A new remote mountable interface module allows for Double-DIN radio installation while still retaining ONSTAR, R.A.P. and control of the factory driver customization menus
- Painted scratch-resistant matte black



99-3303B Turbo



CHEVROLET Malibu | Cobalt | PONTIAC G6 2004-2008

- Retains ONSTAR, RAP and control of the factory driver customization menus
- Painted scratch-resistant matte black



95-3304



CHEVROLET Corvette | Uplander PONTIAC Montana SV6 | SATURN Relay BUICK Terraza | HUMMER H3 2005-2013

- Designed specifically for the installation of Double-DIN radios
- Painted matte black to match factory finish

GENERAL MOTORS



99-3304

P

CHEVROLET **Corvette** | Uplander
PONTIAC **Montana SV6** | SATURN **Relay**
BUICK **Terraza** | HUMMER **H3 2005-2013**

- Metra's patented quick release snap-in ISO mounting system with ISO trim ring
- Recessed Single-DIN mount
- Painted matte black to match factory finish



95-3305

P

D

GM **Multi-Kit** 2006-UP***

- Designed specifically for the installation of Double-DIN radios
- Painted matte black to match factory finish



99-3305

P

GM **Multi-Kit** 2006-UP***

- Metra's patented quick release snap-in ISO mounting system with ISO trim ring
- Recessed Single-DIN opening
- Storage pocket with built-in radio supports below the radio opening
- Painted matte black to match factory finish



95-3306

T

D

CHEVROLET **Aveo 2007-2011**
PONTIAC **G3 2009-2010**

- Designed specifically for the installation of Double-DIN radios
- Textured for a clean factory appearance



99-3306

D

CHEVROLET **Aveo 2007-2011**
PONTIAC **G3 2009-2010**

- Metra's patented quick release snap-in ISO mounting system with ISO trim ring
- Removable oversized storage pocket with built-in radio supports
- Includes parts for installation of Double-DIN radios or two Single-DIN radios



99-3307G Turbo

P

D

CHEVROLET **Equinox 2010-2015** | GMC **Terrain 2010-2014** (with monochrome display)

- Use 99-3308G for color display models
- Unique design for a complex vehicle, places the radio in the factory disc location
- Parts included for both Single-DIN and Double-DIN installations
- Painted gray to match the factory finish



99-3308G Turbo

P

D

CHEVROLET **Equinox** | GM **Terrain 2013-2017** (with color display)

- Parts included for Double-DIN installations
- The included interface retains the factory color display screen and all harnessing for radio installation
- Painted gray to match the factory finish



99-3309B Turbo

P

D

CHEVROLET **Spark 2013-2015**

- For installation of Single-DIN and Double-DIN radios
- Included interface retains factory OnStar®, Bluetooth®, all warning chimes, provides a 12 volt accessory power, VSS, parking brake and reverse signals
- Painted scratch-resistant matte black



99-3309B-LC Turbo

P

D

CHEVROLET **Spark 2013-2015**

- For installation of Single-DIN and Double-DIN radios
- Included "essentials only" interface retains all warning chimes and provides 12 volt accessory power
- Painted scratch-resistant matte black



95-3310B



CHEVROLET **Traverse 2013-2017** | GMC **Acadia 2013-2016** | GMC **Acadia Limited 2017**
 BUICK **Enclave 2013-2017**

- Designed for Double-DIN installations
- Painted scratch-resistant matte black



99-3310B



CHEVROLET **Traverse 2013-2017** | GMC **Acadia 2013-2016** | **Acadia Limited 2017**
 BUICK **Enclave 2013-2017**

- Pocket included for Single-DIN installations
- Painted scratch-resistant matte black



89-30-3310



PONTIAC **Sunbird 1989-1994**

Custom Trim Plate

- Mounts aftermarket radio in factory cassette location
- Can also be used in other applications that require a cover for a large hole like RVs



99-3311B



CHEVROLET **Camaro 1997-2002**

- A replacement for the factory dash panel now allows for a Double-DIN installation in a popular application
- Available in scratch-resistant matte black



95-3312G



PONTIAC **Firebird 1993-2002**

- Designed for Double-DIN installations
- Painted to match the factory color and finish



95-3314G



CHEVROLET **Malibu 2013-2015**

Malibu Limited 2016 (with manual climate controls)

- Specific for Double-DIN installations
- Painted to match the factory color and finish
- Multiple interfaces available for vehicle integration are sold separately



99-3314G



CHEVROLET **Malibu 2013-2015**

Malibu Limited 2016 (with manual climate controls)

- Pocket included for Single-DIN installations
- Painted to match the factory color and finish
- Multiple interfaces available for vehicle integration are sold separately



95-3318B



CHEVROLET **Malibu 2013-2015**

Malibu Limited 2016 (with auto climate controls)

- Designed for installation of ISO Double-DIN radios with an AV input
- Retains the factory personalization menu, climate controls status, and OnStar
- Pre-wired AXSWC harness (AXSWC sold separately)
- Painted scratch-resistant matte black



99-3320

PONTIAC **Grand Am 1996-2000**

Sunfire 1995-1999 | **Grand Prix 1994-2003**

Bonneville 1994-1999 | **Firebird/Trans Am 1993-2002**

- Includes easy-to-use instructions and all necessary hardware

GENERAL MOTORS

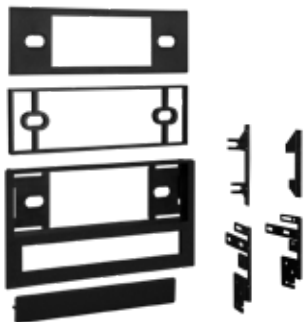

99-3400

CHEVROLET | GEO | ISUZU | HONDA

Multi-Kit 1985-1995**

- Professional Installer Series TurboKit offers quick conversion from 2-shaft to DIN
- Allows for installation of 1/4" or 1/2" DIN equalizer

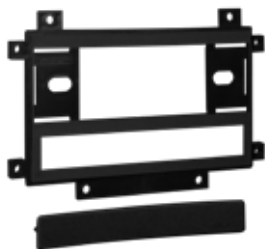

99-3410

CHEVROLET **Tracker 1998-2004**

GEO **Metro** | SUZUKI **Swift 1993-1994**

GEO **Tracker** | SUZUKI **Sidekick 1993-1998**

Grand Vitar 1992-2002 | **XL7 2001-2002**

Aerio 2002 | **Esteem 1995-2003**

- Professional Installer Series TurboKit offers quick conversion from 2-shaft to DIN

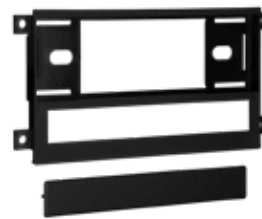

99-3411

GEO **Metro** | SUZUKI **Swift 1995-2001**

- Professional Installer Series TurboKit offers quick conversion from 2-shaft to DIN
- Includes a recessed DIN opening
- Allows installation of 1/4" or 1/2" DIN equalizer



99-3412

GEO **Prizm 1993-1997**

- Professional Installer Series TurboKit offers quick conversion from 2-shaft to DIN



99-3413

CHEVROLET **Prizm** | TOYOTA **Corolla 1998-2002**

- Retains factory cup holder



95-3527



PONTIAC **Grand Prix 2004-2008**

- Designed specifically for the installation of Double-DIN radios



99-3527

PONTIAC **Grand Prix 2004-2008**

- Holds either DIN or ISO DIN units
- Metra's patented quick release snap-in ISO mounting system with ISO trim ring

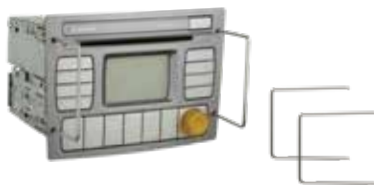

86-3528

PONTIAC **GTO Radio Removal Tool**



95-3528G



PONTIAC **GTO 2004-2006**

- Designed specifically for the installation of Double-DIN radios
- Painted gray to match factory finish
- Also available in painted matte black 95-3528B



95-3528B



PONTIAC **GTO 2004-2006**

- Designed specifically for the installation of Double-DIN radios
- Painted matte black to match factory finish



99-3528

PONTIAC **GTO 2004-2006**

- Recessed Single-DIN opening
- Oversized under-radio storage pocket



99-3900

CHEVROLET | OLDSMOBILE | PONTIAC

Multi-Kit 1994-2004**

- Exclusive for EQ applications only
- Easy conversion from 2-shaft to Single-DIN opening



99-4000

GM Premium Multi-Kit with Pocket**

BUICK | CADILLAC | CHEVROLET | GMC OLDSMOBILE | PONTIAC | SATURN **1982-2005**

- Special design accommodates Single-DIN, Single-DIN pullout and removable face Single-DIN radios
- Comes with under radio CD jewel case pocket
- Unique design with rounded edges



89-99-4002

GM Component Parts

- 1" trim plate (use with 87-09-4012 or 87-09-4544)



87-09-4012

GM Metal Basket

- Use with left-over trim plates from 99-4012, or use with: 89-99-4000, 89-99-4001, 89-99-4002



99-4012

GM Premium Pullout Multi-Kit with Flat, 1/2" & 1" Extensions**

BUICK | CADILLAC | CHEVROLET | GMC OLDSMOBILE | PONTIAC | SATURN **1982-2005**

- Comes complete with three ABS plastic faceplates: flat, 1/2" and 1" extension which snap onto the metal basket



99-4500

GM Multi-Kit 1/2" Extension**

BUICK | CADILLAC | CHEVROLET | GMC OLDSMOBILE | PONTIAC | SATURN **1982-2005**

- Professional Installer Series TurboKit
- Round edges finish off the face design
- Designed to use original equipment factory brackets or the 02-4544 bracket kit (optional)



99-4544

GM Premium Multi-Kit with EQ Option and Mounting Brackets** BUICK | CADILLAC CHEVROLET | GMC | OLDSMOBILE | PONTIAC SATURN **1982-2005**

- Professional Installer Series Kit
- Comes with four ABS plastic face plates: Flat, 1/2" extension, 1/2" with EQ opening and 1" extension which snap onto the plastic housing

GENERAL MOTORS



99-4545

GM Premium Multi-Kit with EQ Option**
 BUICK | CADILLAC | CHEVROLET | GMC
 OLDSMOBILE | PONTIAC | SATURN **1982-2005**

- Comes complete with four ABS plastic face plates: Flat, 1/2" extension, 1/2" with EQ opening and 1" extension which snap onto the plastic housing
- Designed to use original equipment factory brackets or the optional 02-4544 bracket kit for times when OEM brackets are missing



99-4644

GM Premium Multi-Kit with Mounting Brackets**
 BUICK | CADILLAC | CHEVROLET | GMC
 OLDSMOBILE | PONTIAC | SATURN **1982-2005**

- Comes with three different mounting faceplate depths: flat, 1/2" and 1"
- Can ISO mount a radio at any three faceplate depths
- Comes with rear support
- Designed to use original equipment factory brackets or the 02-4544 bracket kit that is included for times when OEM brackets are missing



99-4700

GM Multi-Kit** BUICK | CADILLAC | CHEVROLET
 GMC | OLDSMOBILE | PONTIAC | SATURN **1982-2005**

- Bracket system design allows to telescope in and out in any increment; not restricted to 1/8" steps
- Designed to use original equipment factory brackets or the optional 02-4544 bracket kit for times when OEM brackets are missing



HARLEY-DAVIDSON®

One piece molded design for solid installation



Rubber gasket to fight vibration and moisture

99-9600

HARLEY-DAVIDSON Touring (FL models with fairing) **1998-2013**

- One-piece design molded in ASA plastic offers durable support
- Rubber trim gasket to fight moisture and vibration
- The new harness is included and is pre-wired for the AXCESS AXSWC to retain handlebar controls
- Also check out Metra's new speaker adapters for these same models
- Also available with included handlebar control interface and antenna adapter as the 99-9613



95-9700WR



HARLEY-DAVIDSON Touring FLH 2014-UP* | Touring FLT 2015-UP*

- Includes data interface accessory power and provides data for factory security system
- Designed for "L" shaped Double-DIN radios
- Handlebar control interface and antenna adapter are included
- Updated to include water-resistant interface box
- Molded in ASA plastic to offer durable support
- Threaded brass inserts to hold upper metal tray





Data interface & harnesses included

Includes LCD screen retains oil pressure and EITMS info

99-9700WR

HARLEY-DAVIDSON Touring FLH 2014-UP* | Touring FLT 2015-UP*

- Includes data interface accessory power and provides data for factory security system
- Includes LCD screen that retains oil pressure and EITMS info
- Designed for Single-DIN radio installations and molded in ASA plastic
- Updated to include water-resistant interface box
- Threaded brass inserts to hold upper metal tray

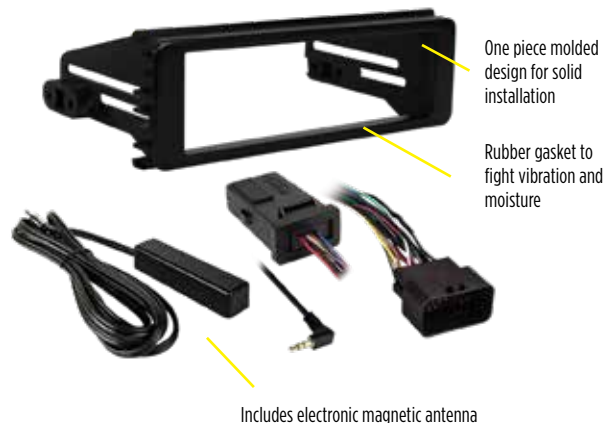

One piece molded design for solid installation

Rubber gasket to fight vibration and moisture

Includes electronic magnetic antenna

99-9713WR

HARLEY-DAVIDSON Touring 1996-2013

(FLH and FLT models with fairing)

- Handlebar audio control retention interface keeps the factory installed audio handlebar controls active when installing an aftermarket radio
- Includes electronic magnetic antenna that can be installed in the fairing so the factory rear mounted antenna mast can be removed
- Water-resistant AXSWC included
- Molded in ASA plastic to offer durable support
- Also check out Metra's new speaker adapters for these same models



Includes European factory antenna

Includes LCD screen Retains oil pressure and EITMS info

Data interface & harnesses included

Includes electronic magnetic antenna

99-9714WR

HARLEY-DAVIDSON Touring FLH 2014-UP* | Touring FLT 2015-UP*

- Handlebar control interface allows the handlebar audio controls to continue working with an aftermarket radio
- LCD info screen provides information about personalization settings
- Includes an electronic antenna that can be installed in the fairing so the factory rear mounted antenna mast can be removed
- Updated water-resistant interface box & AXSWC



99-9800

HARLEY-DAVIDSON Touring (FL models with fairing) 1998-2013

- Hinged, transparent, weather resistant cover
- Strong magnets and a rubber gasket keep the cover tight and in place when closed
- ISO Single-DIN radio provision
- One piece design molded in ASA plastic
- Rubber trim gasket to fight moisture and vibration
- Be sure to purchase the 70-9800 wire harness for a complete installation

HARLEY-DAVIDSON® + POLARIS



95-HDIF

HARLEY-DAVIDSON Touring (with batwing fairing) **1998-2013**

- Designed to allow for the installation of a new style aftermarket Double-DIN large face radio
- Comes with radio mounting kit
- Accommodates aftermarket speakers only, 6.5" to 6.75"
- Made from durable ABS plastic and comes painted black
- Non-painted also available for custom installations (95-HDIF-NP)



Manufactured under one or more of the following U.S. Patents and pending applications: #D891308



95-HDIF2

HARLEY-DAVIDSON Touring (FLT models with Double-DIN radio) **1998-2013**

- Designed to allow for the installation of a new style aftermarket Double-DIN large face radio
- Three sets of speaker plates are included: 6.5", 6"x 9" and a blank so you can add the speaker of your choice
- Retains all original gauges
- Non-painted also available for custom installations (95-HDIF-NP)
- Made from durable ABS plastic and comes painted gloss black

POLARIS

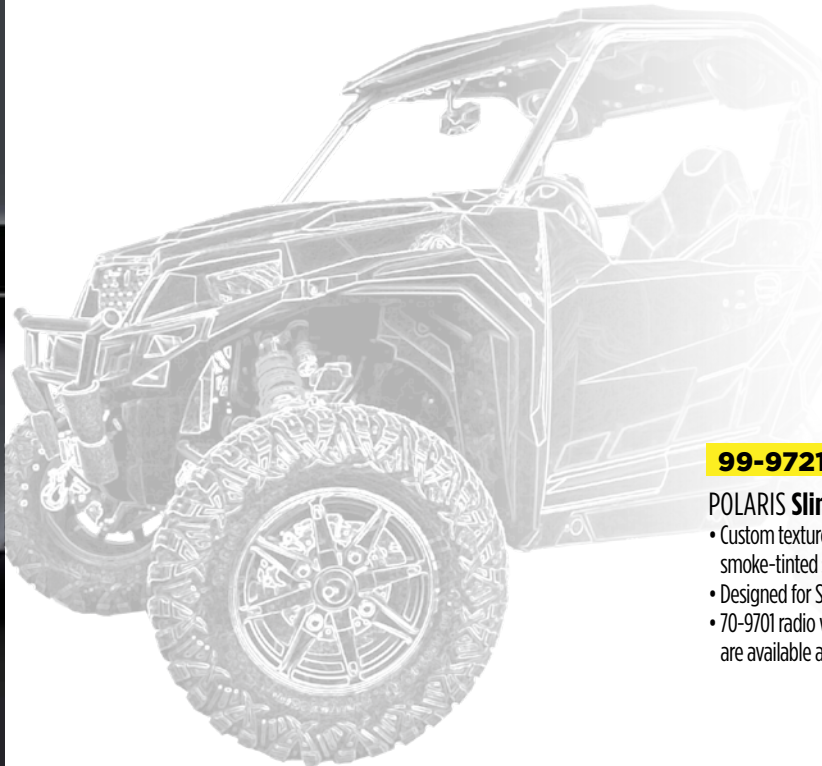

99-9721



POLARIS Slingshot 2015-UP*

- Custom textured trim to match the factory finish with a built-in, retractable, smoke-tinted splash guard
- Designed for Single-DIN with pocket and Double-DIN installations
- 70-9701 radio wire harness, 72-9701 and 72-9702 speaker harness solutions are available and sold separately



MPS-GEN01

POLARIS **General 1000 2016-UP***

- Mounting of ISO Double-DIN radios
- Custom texture
- Replaces OE pocket or cover plate



MPS-GEN02

POLARIS **General 1000 2016-UP***

- Universal blank plate for gauge mount radios
- Custom texture



MPS-RZR01

POLARIS **RZR 900/1000 2014-UP***

- ISO Double-DIN radio provision
- Replaces pocket/cover-plate
- Textured to match factory finish

HONDA



95-7801



HONDA | ACURA **Multi-Kit** 1990-2006**

- Designed specifically for Double-DIN installations
- Rear support bracket is included
- See Multi-Kit guide or Application Chart of this catalog for applications



95-7802CH



HONDA **CR-V 2012-2016**

- Designed specifically for Double-DIN installations
- Painted a charcoal finish to match the factory color and finish



99-7802CH



HONDA **CR-V 2012-2016**

- Pocket included for Single-DIN installations
- Painted a charcoal finish to match the factory color and finish



99-7803G Turbo



HONDA **Accord 2003-2007**

- Design allows for Double-DIN installs
- Electronics integrate with manual, auto and dual zone climate systems
- Painted and textured to match the factory color & finish

Pocket Accessory 88-00-7803 (sold separately)

- Designed as a replacement for the factory Honda pocket when using Metra's 99-7803G installation kit



99-7804B Turbo



HONDA **Accord LX 2013-2017 | EX 2013-2015**

- Designed for both single or Double-DIN installations
- Built and painted as two separate pieces to match the factory color and appearance
- Included interface retains the factory screen and retains control of factory customization menus (lighting, locks, trip info, etc.)

HONDA + ACURA



Interface keeps factory LCD screen alive and retains all vehicle customization menus

99-7804HG Turbo P D

HONDA **Accord LX 2013-2017** | **EX 2013-2015**

- Designed for both Single or Double-DIN installations
- Built and painted as two separate pieces to match the factory color and appearance
- Included interface retains the factory screen and retains control of factory customization menus (lighting, locks, trip info, etc.)



95-7805CH P D

ACURA **TSX 2009-2014** (without NAV)

- Designed specifically for Double-DIN installations
- Painted scratch-resistant, custom colored black
- Use 70-1729 harness and 40-HD10 antenna adapter for a complete installation (sold separately)



99-7805CH P

ACURA **TSX 2009-2014**

- Pocket included for Single-DIN installations
- Painted scratch-resistant, custom colored black
- Use 70-1729 harness and 40-HD10 antenna adapter for a complete installation (sold separately)



99-7806B P D

ACURA **RL 1996-2003** (without factory NAV)

- Parts included for installation of DIN or Double-DIN radios
- Two different trim panels included for an extended year range in one kit
- Trim panels are painted a custom black to match the factory color and finish
- Use 70-1725 harness and antenna adapter is required for a complete installation (sold separately)



95-7807 P D

HONDA **Accord | Crosstour 2008-2012** (with NAV)

- Designed specifically for Double-DIN installations
- Painted to match the factory color and finish

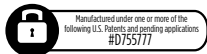

99-7807 P

HONDA **Accord | Crosstour 2008-2012** (with NAV)

- Pocket included for Single-DIN installations
- Painted to match the factory color and finish

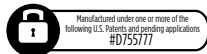

95-7807T P D

HONDA **Accord | Crosstour 2008-2012** (with NAV)

- Designed specifically for Double-DIN installations
- Painted to match the factory color and finish

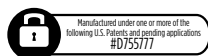

99-7807T P

HONDA **Accord | Crosstour 2008-2012** (with NAV)

- Pocket included for Single-DIN installations
- Painted to match the factory color and finish



99-7808B P D

ACURA **TL 2009-2014**

- Parts included for DIN or Double-DIN installations
- Painted scratch-resistant matte black
- Built to integrate the factory climate controls into the new radio replacement panel



Buttons and LCD retain all climate systems including Dual-Zone equipped cars



99-7809B *Turbo*



ACURA TSX 2004-2008

- Design allows for Double-DIN or Single-DIN installations
- Electronics integrate with the auto/dual-zone climate system

- Painted and textured to match the factory color and finish



95-7810B



HONDA HRV 2016-UP*

- Designed specifically for the installation of ISO Double-DIN radios
- Retains the factory vents in their original location
- Painted scratch-resistant matte black



99-7810B



HONDA HRV 2016-UP*

- Designed specifically for ISO Single-DIN installations
- Retains the factory vents in their original location
- Painted scratch-resistant matte black



95-7811B



HONDA Pilot 2016-UP* | Passport 2019-UP* | Ridgeline 2017-UP*

- (select 2019 NAV models not applicable)
- Designed specifically for the installation of ISO Double-DIN radios
 - Painted matte black with silver trim around vent



99-7811B



HONDA Pilot 2016-UP* | Passport 2019-UP* | Ridgeline 2017-UP*

- (select 2019 NAV models not applicable)
- Designed specifically for ISO Single-DIN installations
 - Painted black with silver trim around vent
 - Includes a pocket



95-7811HG



HONDA Pilot 2016-UP* | Passport 2019-UP* | Ridgeline 2017-UP*

- (select 2019 NAV models not applicable)
- Designed specifically for the installation of ISO Double-DIN radios
 - Painted gloss black with silver trim around vent



99-7811HG



HONDA Pilot 2016-UP* | Passport 2019-UP* | Ridgeline 2017-UP*

- (select 2019 NAV models not applicable)
- Designed specifically for ISO Single-DIN installations
 - Painted gloss black with silver trim around vent
 - Includes a pocket



95-7812B



HONDA Civic LX/LX Sport 2016-UP*

- Designed specifically for the installation of Double-DIN radios
- Painted scratch-resistant matte black

HONDA + ACURA



99-7812B

HONDA Civic LX/LX Sport 2016-UP*

- Includes a storage pocket for Single-DIN installations
- Painted scratch-resistant matte black



99-7814

HONDA | ACURA Multi-Kit* 1988-2006

- Parts included for the installation of both Single-DIN and Double-DIN radios
- Covers a large range of the most popular Acura and Honda applications on the road today
- Textured for a clean factory appearance



95-7815B

ACURA TL 2004-2008

- Specifically designed for Double-DIN installations
- Painted scratch-resistant matte black
- Use the 70-1721 wire harness and 40-HD10 antenna adapter (07-08 only) to complete the installation



99-7815B

ACURA TL 2004-2008

- Pocket included for Single-DIN installations
- Painted scratch-resistant matte black
- Use the 70-1721 wire harness and 40-HD10 antenna adapter (07-08 only) to complete the installation



99-7816G

HONDA Civic 2006-2011

- Double-DIN trim plate and brackets
- Allows for the retention of factory climate controls, air vents, hazard button and passenger airbag light in their original location
- High-grade ABS plastic painted charcoal gray to match factory color as well as contoured and textured to compliment factory dash



99-7816T

HONDA Civic 2006-2011

- Double-DIN trim plate and brackets
- Allows retention of factory climate controls, air vents, hazard button and passenger airbag light in their original location
- High-grade ABS plastic painted taupe to match factory color as well as contoured and textured to compliment factory dash



95-7817HG

HONDA CRV 2017-UP* (LX models only)

- Designed specifically for the installation of Double-DIN radios
- Painted high gloss black to match factory finish.



99-7817HG

HONDA CRV 2017-UP* (LX models only)

- Pocket included for the installation of Single-DIN radios
- Painted high gloss black to match factory finish.



99-7819

HONDA PILOT 2006-2008 (with factory NAV)

- Designed for the installation of both Single-DIN and Double-DIN radios
- Textured ABS for durability with a factory appearance



95-7820B



ACURA MDX 2007-2013

- ISO Double-DIN radio provision
- Complete lower center panel for a clean look
- Will work with both NAV and non-NAV models
- Painted scratch-resistant matte black



99-7820B



ACURA MDX 2007-2013

- ISO Single-DIN radio provision with pocket
- Complete lower center panel for a clean look
- Will work with both NAV and non-NAV models
- Painted scratch-resistant matte black



99-7821B



HONDA Civic 2016-UP*

- Parts included for both ISO Single-DIN and ISO Double-DIN installations
- Touchscreen display for climate, audio interfacing and personalization features
- Included interface for climate and steering wheel functions
- Painted scratch-resistant matte black to match factory finish



99-7860



HONDA Civic SI 2002-2005 (for US models only)

- Will accommodate a full recessed Single-DIN unit with a pocket
- Fits an ISO mount radio with a pocket
- Mounts a Double-DIN unit



95-7861



HONDA Pilot 2003-2008

- Designed specifically for the installation of Double-DIN radios
- For models without factory NAV



99-7861

HONDA Pilot 2003-2008

- Metra's patented quick release snap-in ISO mounting system with ISO trim ring
- For models without factory NAV



95-7862



HONDA Accord 2003-2007

- A Double-DIN option to compliment the existing 99-7862 for Single-DIN
- Special harness included for lower dash mounting and keeping the factory radio in place
- Will work in NAV models



99-7862

HONDA Accord 2003-2007

- Mounts aftermarket radio in console pocket location
- Comes complete with harness that will provide all the connections to install an aftermarket unit using factory speaker, power and ground wires
- Will work in NAV models

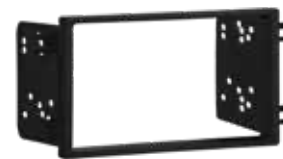
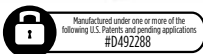

95-7863



HONDA Element 2003-2011

- Double-DIN specific
- Fits all Element trim levels

HONDA + ACURA



99-7863

HONDA Element 2003-2011

- Holds either Single-DIN or ISO Single-DIN units
- Metra's patented quick release snap-in ISO mounting system with ISO trim ring



95-7866B



ACURA MDX 2001-2006

- Painted matte black to match factory finish
- Designed specifically for the installation of Double-DIN radios



99-7866

ACURA MDX 2001-2006

- Holds either Single-DIN or ISO Single-DIN units
- Metra's patented quick release snap-in ISO mounting system with ISO trim ring



95-7867



ACURA RSX 2002-2006

- Designed specifically for the installation of Double-DIN radios
- Has provision for factory hazard button



99-7867

ACURA RSX 2002-2006

- Designed specifically for a Single-DIN installation with pocket
- Metra's patented quick release snap-in ISO mounting system with ISO trim ring
- Has provision for factory hazard button



95-7868B



ACURA CL 2001-2003 | TL 1999-2003

- Painted matte black to match factory finish
- Designed specifically for the installation of Double-DIN radios



99-7868

ACURA CL 2001-2003 | TL 1999-2003

- Holds either Single-DIN or ISO Single-DIN units
- Metra's patented quick release snap-in ISO mounting system with ISO trim ring



99-7869



HONDA Odyssey 2005-2010

- Metra's patented quick release snap-in ISO mounting system with ISO trim ring
- Recessed DIN opening
- Storage pocket with built-in radio supports below the radio opening



95-7870G



HONDA Ridgeline 2005-2014

- Designed specifically for the installation of Double-DIN radios
- Painted dark gray to match factory color and finish



95-7870T



HONDA Ridgeline 2005-2014

- Designed specifically for the installation of Double-DIN radios
- Painted taupe to match factory color and finish



99-7870G



HONDA Ridgeline 2005-2014

- Metra's patented quick release snap-in ISO mounting system with ISO trim ring
- Recessed Single-DIN opening
- Painted dark gray to match factory color and finish



99-7870T



HONDA Ridgeline 2005-2014

- Metra's patented quick release snap-in ISO mounting system with ISO trim ring
- Recessed Single-DIN opening
- Painted taupe to match factory color and finish



99-7872



HONDA Fit 2007-2008

- Custom design allows retention of factory climate controls in their original position and passenger airbag light
- Metra's patented quick release snap-in ISO mounting system with ISO trim ring
- Painted matte black



99-7873



HONDA CRV 2007-2011

- Metra's patented quick release snap-in ISO mounting system with ISO trim ring
- Includes parts for installation of Double-DIN radios or two Single-DIN radios



99-7874



HONDA Accord 2008-2012 (without factory NAV or dual zone climate controls)

- Custom design allows retention of factory climate controls, air vents, hazard button and passenger airbag light in their original location
- Painted matte black to match factory color and texture
- Metra's patented quick release snap-in ISO mounting system with ISO trim ring
- Use the 95-7807 or 99-7807 series for NAV equipped cars



99-7874T



HONDA Accord 2008-2012 (without factory NAV or dual zone climate controls)

- Custom design allows retention of factory climate controls, air vents, hazard button and passenger airbag light in their original location
- Painted taupe to match factory color and texture
- Metra's patented quick release snap-in ISO mounting system with ISO trim ring
- Use the 95-7807 or 99-7807 series for NAV equipped cars



99-7875



HONDA Accord 2008-2012 (without NAV with dual zone climate controls)

- Custom design allows retention of factory climate controls, air vents, hazard button and passenger airbag light in their original location
- Painted matte black to match factory color and texture
- Metra's patented quick release snap-in ISO mounting system with ISO trim ring
- Use the 95-7807 or 99-7807 series for NAV equipped cars



99-7875T



HONDA Accord 2008-2012 (without NAV with dual zone climate controls)

- Custom design allows retention of factory climate controls, air vents, hazard button and passenger airbag light in their original location
- Painted taupe to match the factory color
- Metra's patented quick release snap-in ISO mounting system with ISO trim ring
- Use the 95-7807 or 99-7807 series for NAV equipped cars

**99-7876****HONDA Pilot 2009-2011**

- ISO DIN mount with a storage pocket

**95-7877S****HONDA Fit 2009-2013**

- A new part revised from the existing 99-7877, but now specifically for Double-DIN installations
- Painted silver to match factory finish
- Use 70-1729 harness and 40-HD10 antenna adapter for a complete installation (sold separately)

**99-7877S****HONDA Fit 2009-2013**

- Designed specifically for Single-DIN installations
- Painted silver to match the factory finish
- Use 70-1729 harness and 40-HD10 antenna adapter for a complete installation (sold separately)

**95-7877B****HONDA Fit 2009-2013**

- A new part revised from the existing 99-7877, but now specifically for Double-DIN installations
- Painted scratch-resistant matte black
- Use 70-1729 harness and 40-HD10 antenna adapter for a complete installation (sold separately)

**99-7877B****HONDA Fit 2009-2013**

- Designed specifically for Single-DIN installations
- Painted scratch-resistant matte black
- Use 70-1729 harness and 40-HD10 antenna adapter for a complete installation (sold separately)

**99-7878B****HONDA Insight 2010-2014**

- Designed for Single-DIN and Double-DIN installations
- Painted matte black to match factory finish

**95-7879****HONDA CRZ 2011-2016**

- Custom molded, textured and painted to match the factory finish
- Retains factory hazard button and passenger airbag light
- Designed specifically for the installation of Double-DIN radios

**99-7879****HONDA CRZ 2011-2016**

- Designed specifically for a Single-DIN installation with pocket
- Retains factory hazard button and passenger airbag light
- Includes a storage pocket for Single-DIN installations

**99-7880B****HONDA Odyssey 2011-2013 (without NAV)**

- Painted scratch-resistant matte black to match the factory color and finish
- Utilizes factory brackets for radio support
- Oversized storage pocket included



95-7881G



HONDA Civic 2012-2012

- Designed specifically for the installation of Double-DIN radios
- Painted gray to match factory color and finish



99-7881G



HONDA Civic 2012-2012

- Includes a storage pocket for Single-DIN Installations
- Painted gray to match factory color and finish



95-7882B



HONDA Civic 2013-2015

- Double-DIN installations
- Painted scratch-resistant matte black



99-7882B



HONDA Civic 2013-2015

- Pocket included for Single-DIN installations
- Painted scratch-resistant matte black



95-7883HG



HONDA Fit 2015-UP*

- Specifically designed for Double-DIN installations
- Built-in location for the factory hazard switch and airbag indicator
- Painted high gloss black



99-7883HG



HONDA Fit 2015-UP*

- Pocket included for Single-DIN installations
- Built-in location for the factory hazard switch and airbag indicator
- Painted high gloss black

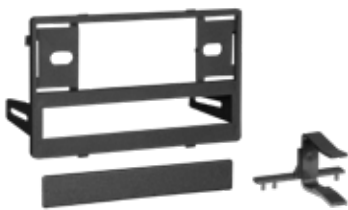

99-7888

**HONDA Accord 1990-1993 | Odyssey 1995-1998
Prelude 1988-1991 | ACURA TL 1996-1998
Vigor 1992-1994 | Integra & Legend 1990-2001
ISUZU Oasis 1996-1998**

- Professional Installer Series TurboKit offers quick conversion from 2-shaft to Single-DIN
- Includes 1/4" or 1/2" DIN equalizer provision with side supports
- Factory-style rear support bracket

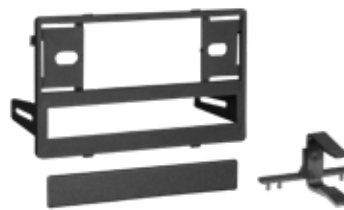

99-7889

HONDA Prelude 1992-1996

- Professional Installer Series TurboKit offers quick conversion from 2-shaft to Single-DIN
- Includes 1/4" or 1/2" DIN equalizer provision with side supports
- Factory-style rear support bracket



99-7890

**HONDA Accord 1990-1997 | Odyssey 1995-1998
ACURA CL 1997-1999 | TL 1996-1998
Vigor 1991-1996 | Integra & Legend
1990-2001 | ISUZU Oasis 1996-1998**

- Includes 1/4" or 1/2" DIN equalizer provision with side supports
- Factory-style rear support bracket

HONDA + ACURA



99-7891

HONDA Civic Custom Kit 1996-1998
 • Accommodates Single-DIN and 2-shaft radios
 • Retains the factory pocket



99-7892

HONDA Accord 1990-1997 | Odyssey 1995-1998
ACURA CL 1997-1999 | TL 1996-1998
Vigor 1991-1996 | Integra & Legend 1990-2001
ISUZU Oasis 1996-1998
 • Accommodates DIN, ISO DIN and 2-shaft radios
 • Comes complete with built-in pocket that holds two CD jewel cases



99-7893

HONDA CRV | Prelude 1997-2001
 • Pocket holds two CD jewel cases
 • Easy conversion from 2-shaft to Single-DIN

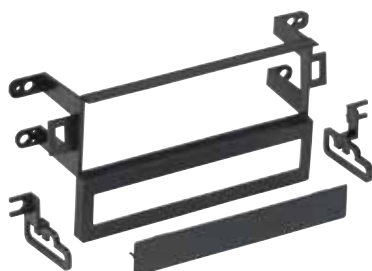

99-7894

HONDA Accord 1998-2002
 • Includes recessed Single-DIN opening with the option to retain the factory pocket
 • Allows the installation of a 1/4" or 1/2" DIN equalizer
 • Includes EQ / factory pocket retention supports
 • Equalizer trim plate included for times when no EQ is installed



95-7895

HONDA Accord 1998-2002
 • Designed specifically for the installation of Double-DIN radios



99-7895

HONDA Accord 1998-2002 (with pocket)
 • Pocket holds three CD jewel cases



99-7896

HONDA Civic 1999-2000
 • Professional Installer Series TurboKit offers quick conversion from 2-shaft to Single-DIN
 • Pocket holds two CD jewel cases



99-7897

HONDA Civic | Civic Hybrid 2001-2005
 • Matches the factory dash contour perfectly
 • Allows the installation of ISO Single-DIN or Single-DIN mount radios

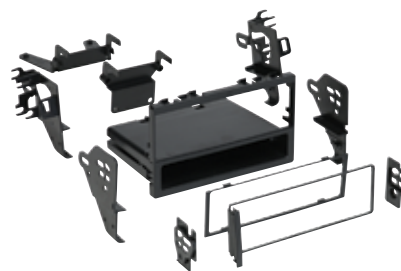

99-7898

HONDA | ACURA Multi-Kit 1988-2006**
 • Provides pocket with mounting of a Single-DIN radio or an ISO Single-DIN radio
 • Includes rear support bracket





95-7899



HONDA **Civic 2001-2005**

(Excludes Si & 2005 SE Models)

- Allows for two stacked ISO Single-DIN radios or a Double-DIN radio using the factory brackets



99-7899

HONDA **Civic 2001-2005**

(Excludes Si & 2005 SE Models)

- For ISO DIN and DIN mount radios

HYUNDAI+KIA



95-1003



KIA **Sephia 1995-2001 | Sportage 1995-2002**

Rio 2001 | Spectra 2000-2001

- Designed specifically for the installation of Double-DIN radios

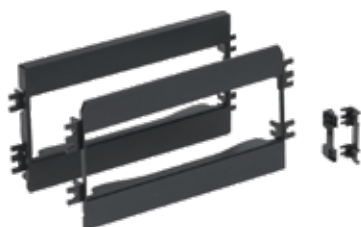

99-1003

KIA **Sephia 1995-2001 | Sportage 1995-2002**
Rio 2001 | Spectra 2000-2001

- Designed specifically for the installation of Single-DIN radios
- Includes multiple faceplates

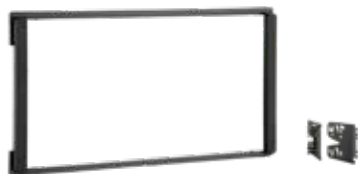

95-1005



KIA **Sedona 2002-2005 | Spectra 2000-2006**
Rio 2002-2005 | Sorrento LX (excluding sport packages) **2003-2006**

- Designed specifically for the installation of Double-DIN radios



99-1005

KIA **Sedona 2002-2005 | Spectra 2002-2004**

- Provides pocket with recessed mounting of a DIN radio or an ISO DIN radio using Metra's patented ISO Quick-Release Brackets
- Comprehensive instruction manual
- All necessary hardware included for easy installation



95-1006



KIA **Sorento EX | LX Sport 2003-2006**

- Designed specifically for the installation of ISO Double-DIN radios
- Fills a specific application gap where no product was previously available



99-1006

KIA **Sorento EX 2003-2006**

LX (with sport package) **2004-2006**

- Recessed Single-DIN radio opening ISO mount radio compatible using snap-in ISO radio mounts
- Comes complete with built-in under-radio pocket



99-1007

KIA **Rio 2002-2005**

- Recessed Single-DIN radio opening
- ISO mount radio compatible using snap-in ISO radio mounts
- Comes complete with built-in under-radio pocket

**99-1008**

KIA Sorento LX 2003-2006

Spectra 2004-2006

- Recessed DIN radio opening
- ISO mount radio compatible using Snap-In ISO radio mounts
- Comes complete with built-in under-radio pocket

**99-7301**

HYUNDAI Multi-Kit** 1986-2005

- Professional Installer Series TurboKit offers quick conversion from 2-shaft to Single-DIN

**99-7308**

HYUNDAI Accent 1995-2005

Elantra 1996-2000 | Sonata 1995-1998

Tiburon 1997-2001

- Professional Installer Series TurboKit

**95-7309**

HYUNDAI Elantra 1996-2000

Sonata 1995-2001 | Tiburon 1997-2001

Santa Fe 2001-2006

- Designed specifically for the installation of Double-DIN radios

**99-7309**

HYUNDAI Elantra 1996-2000

Sonata 1995-2001 | Tiburon 1997-2001

Santa Fe 2001-2006

- Professional Installer Series TurboKit designed for Hyundai models with 4" dash openings
- For DIN mount radio applications
- Pocket holds CD jewel cases

**99-7310**

HYUNDAI Accent 2000-2001

- Professional Installer Series TurboKit fits ISO Single-DIN radios

**99-7312**

HYUNDAI Tiburon 1997-2001

- Professional Installer Series TurboKit for ISO mount applications only
- Contoured to match factory dashboard

**95-7313**

HYUNDAI Elantra 2001-2006

Sonata 2002-2005 | Tiburon 2003-2008

KIA Optima 2001-2006

- Designed specifically for the installation of Double-DIN radios

**99-7313**

HYUNDAI Elantra 2001-2006

Sonata 2002-2005 | Tiburon 2003-2008

KIA Optima 2001-2006

- Professional Installer Series TurboKit for Single-DIN mount radio applications only
- Integrally designed pocket holds CD jewel cases

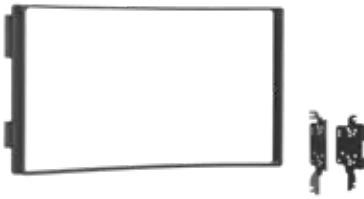

95-7315



HYUNDAI Tucson 2005-2009

- Designed specifically for the installation of Double-DIN radios



99-7315

HYUNDAI Tucson 2005-2009

- Recessed Single-DIN opening
- Metra's patented snap-in ISO support system
- Comes with oversized under-radio storage pocket



99-7316

HYUNDAI XG 300 2001 | XG 350 2002-2005

- Metra's patented quick release snap-in ISO mounting system with ISO trim ring
- Recessed Single-DIN opening



99-7317

KIA Sportage 2005-2010

- Recessed Single-DIN opening
- Storage pocket with built-in radio supports



95-7318

KIA Spectra 2005-2006

- Designed specifically for the installation of Double-DIN radios



99-7318

KIA Spectra 2005-2006

- Metra's patented quick release snap-in ISO mounting system with ISO trim ring
- Storage pocket with built-in radio supports below the radio opening
- High-grade ABS plastic contoured and textured to compliment factory dash



95-7319



KIA Amanti 2004-2006

- Designed for the installation of Double-DIN radios to compliment the existing 99-7319 kit



99-7319

KIA Amanti 2004-2006

- Metra's patented quick release snap-in ISO mounting system with ISO trim ring
- Storage pocket with built-in radio supports below the radio opening



95-7320



HYUNDAI Sonata 2006-2008

- Includes parts for installation of Double-DIN radios



99-7320

HYUNDAI **Sonata 2006-2008**

- Designed specifically for a Single-DIN head unit
- Includes built-in storage pocket

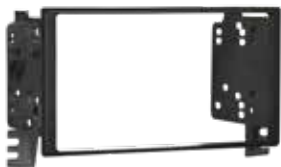

95-7321

HYUNDAI **Accent** | KIA **Rio 2006-2011**

- Designed specifically for the installation of Double-DIN radios



99-7321

HYUNDAI **Accent** | KIA **Rio 2006-2011**

- Metra's patented quick release snap-in ISO mounting system with ISO trim ring
- Storage pocket with built-in radio supports below the radio opening



95-7322

T D

HYUNDAI **Azera 2006-2011** (for US models only)

- Includes parts for installation of Double-DIN radios
- Contoured and textured to match factory dash



99-7322

HYUNDAI **Azera 2006-2011** (US models only)

- Metra's patented quick release snap-in ISO mounting system with ISO trim ring
- Recessed Single-DIN opening



95-7323

D

HYUNDAI **Entourage 2007-2008**

KIA **Sedona 2006-2014**

- Designed for installation of Double-DIN radios



99-7323

HYUNDAI **Entourage 2007-2008**
KIA **Sedona 2006-2014**

- Metra's patented quick release snap-in ISO mounting system with ISO trim ring
- Built-in oversized storage pocket with built-in radio supports
- Recessed Single-DIN opening



95-7324

D

KIA **Optima 2006-2010**

- Designed for installation of Double-DIN or two Single-DIN radios



99-7324

KIA **Optima 2006-2010**

- Built-in oversized storage pocket with built-in radio supports
- Metra's patented quick release snap-in ISO mounting system with ISO trim ring
- Recessed Single-DIN opening

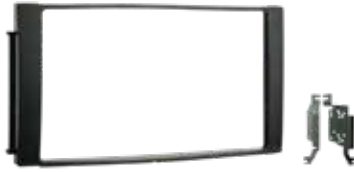

95-7325B



HYUNDAI Santa Fe 2007-2012

(excludes 2008-2012 NAV models)

- High-grade ABS contoured to match factory dash
- Includes parts for installation of Double-DIN radios
- 95-7325S available in silver



99-7325B

HYUNDAI Santa Fe 2007-2012

(excludes 2008-2012 NAV models)

- Metra's patented quick release snap-in ISO mounting system with ISO trim ring
- 99-7325S available in silver



95-7326



HYUNDAI Elantra 2007-2010 (U.S. models only)

- Includes parts for installation of Double-DIN radios



99-7326

HYUNDAI Elantra 2007-2010 (U.S. models only)

- Metra's patented, quick release snap-in, ISO mount system with custom trim ring
- Built-in oversized storage pocket with built-in radio supports
- Recessed Single-DIN opening

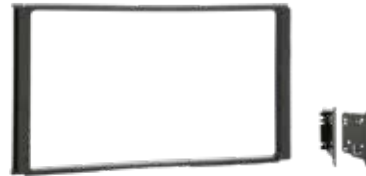

95-7328



KIA Sorrento 2007-2009

- Designed for installation of Double-DIN
- Contoured and textured to match factory dash



99-7328

KIA Sorrento 2007-2009

- Built-in oversized storage pocket with built-in radio supports
- Metra's patented quick release snap-in ISO mounting system with ISO trim ring
- Recessed Single-DIN opening



95-7329



KIA Rondo 2007-2010

- Designed for installation of Double-DIN radios
- Contoured and textured to match factory dash



99-7329

KIA Rondo 2007-2010

- Built-in oversized storage pocket with built-in radio supports
- Metra's patented quick release snap-in ISO mounting system with ISO trim ring
- Recessed DIN opening



95-7330



KIA Spectra | Spectra5 2007-2009

- Designed for installation of Double-DIN radios



99-7330

KIA Spectra | Spectra5 2007-2009

- Built-in oversized storage pocket with built-in radio supports
- Metra's patented quick release snap-in ISO mounting system with ISO trim ring



95-7331



KIA Amanti 2007-2009

- Designed for installation of Double-DIN radios



99-7331

KIA Amanti 2007-2009

- Built-in oversized storage pocket with built-in radio supports
- Metra's patented quick release snap-in ISO mounting system with ISO trim ring



95-7332



HYUNDAI Elantra 2007-2010

(for factory radio delete option)

- Includes parts for installation of Double-DIN radios



99-7332

HYUNDAI Elantra 2007-2010

(for factory radio delete option)

- Metra's patented quick release snap-in ISO mounting system with ISO trim ring
- Built-in oversized storage pocket with radio supports



95-7333



HYUNDAI Sonata 2009-2010

- Designed specifically for the installation of Double-DIN radios
- Painted to match bronze OEM color and finish



99-7333



HYUNDAI Sonata 2009-2010

- Metra's patented quick release snap-in ISO mounting system with ISO trim ring
- Recessed Single-DIN opening
- Painted to match bronze OEM color and finish



99-7334



KIA Borrego 2009-2010

- Metra's patented quick release snap-in ISO mounting system with ISO trim ring
- Designed for both Single-DIN and Double-DIN installations



99-7335S



HYUNDAI Veracruz Limited 2007-2012

(automatic climate control only)

- Painted silver to match factory dash
- Designed for both Single-DIN and Double-DIN radios



95-7336S



HYUNDAI Genesis Coupe 2010-2011
(without NAV)

- For use with automatic climate control
- Designed for Double-DIN radio installations
- Painted silver to match factory dash
- Also available in black 95-7336B



99-7336S



HYUNDAI Genesis Coupe 2010-2011
(without NAV)

- For use with automatic climate control
- Designed for Double-DIN radio installations
- Painted silver to match factory dash



95-7337B



KIA Soul 2010-2011

- Painted a scratch-resistant matte black to match factory dash
- Double-DIN radio provision



99-7337B



KIA Soul 2010-2011

- Painted a scratch-resistant matte black to match factory dash
- ISO Single-DIN radio provision



99-7338B



KIA Forte 2010-2013

- For installation of Double-DIN and Single-DIN radios
- Painted matte black to match factory color and finish

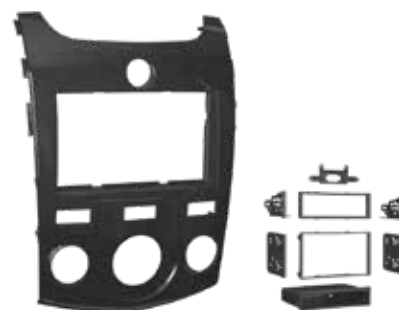

99-7338HG



KIA Forte 2010-2013

- For installation of Double-DIN and Single-DIN radios
- Painted high gloss black to match factory color and finish



99-7338S



KIA Forte 2010-2013

- For installation of Double-DIN and Single-DIN radios
- Painted silver to match factory color and finish



95-7339B



HYUNDAI Genesis Coupe 2010-2012

- For use with manual climate control
- Painted black to match factory dash
- Designed for Double-DIN radio installations



99-7339B



HYUNDAI Genesis Coupe 2010-2012

- Designed for ISO Single-DIN installations with included pocket
- Painted black to match factory dash
- ISO Single-DIN radio provision

HYUNDAI+KIA

**95-7339S**HYUNDAI **Genesis Coupe 2010-2012**

- Designed for Double-DIN radio installations
- For use with manual climate control
- Painted silver to match factory dash

**99-7339S**HYUNDAI **Genesis Coupe 2010-2012**

- For use with manual climate control
- Painted silver to match factory dash
- Designed for ISO Single-DIN radio installations with included pocket

**95-7340B**KIA **Sorento 2011-2013**

- For installation of Single-DIN radios use 99-7340B
- Painted matte black to match OEM color and finish

**99-7340B**KIA **Sorento 2011-2013**

- For installation of Double-DIN radios use 95-7340B
- Painted matte black to match OEM color and finish

**99-7341B**HYUNDAI **Tucson 2014-2015**

- (without 4.3" radio screen)
- Parts included for Double-DIN and Single-DIN radio installations
- Painted matte black to match factory finish

**99-7342**HYUNDAI **Sonata 2011** (excluding Limited models)**Sonata 2012-2014** (without NAV)

- For models equipped with manual climate controls
- Parts included for Single-DIN and Double-DIN installations
- Large panel is painted three different colors to match the factory finish

**99-7343**HYUNDAI **Sonata 2011** (limited without OE NAV)

- For models equipped with auto climate controls
- Parts included for Single-DIN and Double-DIN installations
- Large panel is painted three different colors to match factory

**95-7344CH**KIA **Sportage 2011-2016**

- Included brackets support the Double-DIN radio while the radio panel snaps over to trim
- Provision to retain the factory passenger airbag light
- Painted charcoal to match factory

**99-7344CH**KIA **Sportage 2011-2016**

- Brackets and an oversized storage pocket compliment the Single-DIN radio's installation
- Provision to retain the factory passenger airbag light
- Painted charcoal to match factory



95-7344G



KIA Sportage 2011-2016

- Included brackets support the Double-DIN radio while the radio panel snaps over to trim
- Provision to retain the factory passenger airbag light
- Painted gray to match the factory color



99-7344G



KIA Sportage 2011-2016

- Brackets and an oversized storage pocket compliment the Single-DIN radio installation
- Provision to retain the factory passenger airbag light
- Painted gray to match the factory color



95-7345B



KIA Optima 2011-2013

- Specifically designed for installation of Double-DIN radios
- Painted scratch-resistant matte black to match the factory color and finish



99-7345B



KIA Optima 2011-2013

- Oversized storage pocket included
- Painted scratch-resistant matte black to match the factory color and finish



99-7346B



HYUNDAI Elantra 2011-2013

- Designed for the installation of Single-DIN and Double-DIN radios
- Painted scratch-resistant matte black to match factory color and finish



99-7347B



HYUNDAI Accent 2012-2017

- Designed for the installation of ISO Single-DIN or Double-DIN radios
- Painted scratch-resistant matte black to match factory color and finish
- Radio Delete models use kit 99-7348B



99-7348B



HYUNDAI Accent 2012-2013 (without factory radio)

- Designed specifically for vehicles without factory radios
- For the installation of ISO Single-DIN or Double-DIN radios
- Pocket included for installation of ISO Single-DIN radios



95-7349B



KIA Soul 2012-2013 (without NAV)

- Designed specifically for Double-DIN installations
- Painted scratch-resistant matte black to match the factory color and finish



99-7349B



KIA Soul 2012-2013 (without NAV)

- Pocket included for Single-DIN installations
- Painted scratch-resistant matte black to match the factory color and finish

 Manufactured under one or more of the following U.S. Patents and pending applications #D716791

**95-7350B**HYUNDAI **Veloster 2012-2017**

- Designed specifically for Double-DIN installations
- Painted scratch-resistant matte black to match the factory color and finish

**99-7350B**HYUNDAI **Veloster 2012-2017**

- Pocket included for Single-DIN installations
- Painted scratch-resistant matte black to match the factory color and finish

**95-7352B**HYUNDAI **Genesis Coupe 2013-2016**

- (without navigation)
- Designed specifically for Double-DIN installations
- Painted scratch-resistant matte black to match the factory color and finish

**99-7352B**HYUNDAI **Genesis Coupe 2013-2016**

- (without navigation)
- Pocket included for Single-DIN installations
- Painted scratch-resistant matte black to match the factory color and finish

**99-7353CH**KIA **Rio 2012-2015**

- Designed specifically for Double-DIN installations
- Engineered to retain factory components and switches like hazard, push to start, climate vents and airbag indicators
- Painted scratch-resistant charcoal to match the factory color and finish

**99-7353CH**KIA **Rio 2012-2015**

- Pocket included for Single-DIN installations
- Engineered to retain factory components and switches like hazard, push to start, climate vents and airbag indicators
- Painted scratch-resistant charcoal to match the factory color and finish

**95-7354B**HYUNDAI **Santa Fe 2013-2016**

- (without navigation)
- Designed specifically for Double-DIN installations
- Painted scratch-resistant matte black to match the factory color and finish

**99-7354B**HYUNDAI **Santa Fe 2013-2016**

- (without navigation)
- Pocket included for Single-DIN installations
- Painted scratch-resistant matte black to match the factory color and finish

**95-7355B**KIA **Sorento 2014-2015** (without navigation)

- Double-DIN installations
- Painted scratch-resistant matte black



99-7355B



- KIA Sorento 2014-2015** (without navigation)
- Pocket included for Single-DIN installations
 - Painted scratch-resistant matte black



95-7356B



- KIA Forte 2014-2018***
- Double-DIN installations
 - Painted scratch-resistant matte black



99-7356B



- KIA Forte 2014-2018***
- Pocket included for Single-DIN installations
 - Painted scratch-resistant matte black

Manufactured under one or more of the following U.S. Patents and pending applications #D725095



95-7357HG



- HYUNDAI Elantra GT 2013-2017** (without NAV)
- Double-DIN installations
 - Painted high gloss black
 - Use 70-7304 harness for a complete installation (sold separately)



99-7357HG



- HYUNDAI Elantra GT 2013-2017** (without NAV)
- Pocket included for Single-DIN installations
 - Painted high gloss black
 - Use 70-7304 harness for a complete installation (sold separately)



99-7358



- HYUNDAI | KIA Multi-Kit** 1996-2010** (excluding OE NAV models)
- Parts included for installation of both Single-DIN and Double-DIN radios
 - Multiple trim-plates and bracket provide a large number of vehicle applications



95-7359B



- KIA Optima 2014-2015** (without NAV)
- Specific for Double-DIN installations
 - Painted to match the factory color and finish
 - Use 70-7304 or AX-HYKIA-SWC harness for a complete installation (sold separately)

Manufactured under one or more of the following U.S. Patents and pending applications #D757708



99-7359B



- KIA Optima 2014-2015** (without NAV)
- Pocket included for Single-DIN installations
 - Painted to match the factory color and finish
 - Use 70-7304 or AX-HYKIA-SWC harness for a complete installation (sold separately)

Manufactured under one or more of the following U.S. Patents and pending applications #D757708



95-7360B



- KIA Soul 2014-2019** (excluding models with OE NAV and/or auto climate)
- Specific for Double-DIN installations
 - Painted to match the factory color and finish

HYUNDAI+KIA



99-7360B



KIA Soul 2014-2019
(excluding models with OE NAV and/or auto climate)

- Pocket included for Single-DIN installations
- Painted to match the factory color and finish



95-7361S



HYUNDAI Santa Fe 2010-2012 (with factory NAV)

- Specifically designed for Double-DIN installations
- Painted to match the factory color and finish



95-7362B



HYUNDAI Elantra 2014-2016

- Specific for Double-DIN installations
- Painted to match the factory color and finish



99-7362B



HYUNDAI Elantra 2014-2016

- Pocket included for Single-DIN installations
- Painted to match the factory color and finish



DP-7363B



HYUNDAI Sonata 2015-2017 | Sonata Hybrid 2016-2017

- One of the largest radio replacement kits available... ever!
- Parts included for Single-DIN or Double-DIN installations
- Painted a custom scratch-resistant matte black



95-7364B



HYUNDAI Tucson 2014-2016
(with 4.3" OE screen or NAV)

- Painted scratch-resistant matte black
- Specific for Double-DIN installations



99-7364B



HYUNDAI Tucson 2014-2016
(with 4.3" OE screen or NAV)

- Painted scratch-resistant matte black
- Pocket included for Single-DIN installations



95-7365B



KIA Sedona 2015-UP* (without NAV)

- Specifically designed for Double-DIN installations
- Painted scratch-resistant matte black



99-7365B



KIA Sedona 2015-UP* (without NAV)

- Packaged with a pocket for Single-DIN installation
- Painted scratch-resistant matte black



95-7366B



- KIA **Sorento 2016** (without NAV)
Sorento 2017-2018 (without NAV, with touchscreen)
Sorento 2019-UP* (all trims)
- Designed specifically for the installation of ISO Double-DIN radios
 - Painted scratch-resistant matte black



99-7366B



- KIA **Sorento 2016** (without NAV)
Sorento 2017-2018 (without NAV, with touchscreen)
Sorento 2019-UP* (all trims)
- Designed specifically for single ISO DIN installations
 - Painted scratch-resistant matte black



99-7367B



- KIA **Rio 2016-2017**
- Specific for models with factory push to start
 - Provisions for retaking the factory clock or storage pocket
 - Designed for installation of both Single-DIN and Double-DIN radios
 - Painted scratch-resistant matte black



99-7367HG



- KIA **Rio 2016-2017**
- Specific for models with factory push to start
 - Provisions for retaining the factory clock or storage pocket
 - Designed for installation of both Single-DIN and Double-DIN radios
 - Painted gloss black



99-7368B



- KIA **Rio 2016-2017** (without push to start)
- Designed for installation of both Single-DIN and Double-DIN radios
 - Painted scratch-resistant matte black



99-7368HG



- KIA **Rio 2016-2017** (without push to start)
- Designed for installation of both Single-DIN and Double-DIN radios
 - Painted gloss black



95-7369B



- HYUNDAI **Tucson 2016-2018**
- Designed specifically for the installation of Double-DIN radios
 - Molded vent icons retain factory look
 - Painted scratch-resistant matte black



99-7369B



- HYUNDAI **Tucson 2016-2018**
- Includes a storage pocket for Single-DIN installations
 - Molded vent icons retain factory look
 - Painted scratch-resistant matte black



99-7370B



- KIA **Picanto 2015-UP***
- Parts included for Single-DIN or Double-DIN installations
 - Painted scratch-resistant matte black

 Manufactured under one or more of the following U.S. Patents and pending applications #D789350



95-7376B

P D

HYUNDAI **Elantra 2017-2018**

- Specifically designed for Double-DIN installations
- Painted scratch-resistant matte black

Manufactured under one or more of the following U.S. Patents and pending applications: #D826921



99-7376B

P

HYUNDAI **Elantra 2017-2018**

- Specifically designed for Single-DIN installations
- Painted scratch-resistant matte black

Manufactured under one or more of the following U.S. Patents and pending applications: #D831023



95-7377B

P D

KIA **Optima 2016** (without OE NAV) | **Optima 2017-2018** (with 5" screen)

- Specifically designed for Double-DIN installations
- Painted scratch-resistant matte black

Manufactured under one or more of the following U.S. Patents and pending applications: #D831022



99-7377B

P

KIA **Optima 2016** (without OE NAV) | **Optima 2017-2018** (with 5" screen)

- Pocket included for Single-DIN installations
- Painted scratch-resistant matte black

Manufactured under one or more of the following U.S. Patents and pending applications: #D837782



95-7378B

P D

KIA **Sportage LX 2017-2018** (with 5" screen)

- Specifically designed for Double-DIN installations
- Painted scratch-resistant matte black



99-7378B

P

KIA **Sportage LX 2017-2018** (with 5" screen)

- Includes a pocket for Single-DIN installations
- Painted scratch-resistant matte black



99-7379HG

N P D

HYUNDAI **Elantra GT 2013-2015** (with NAV)

- Pocket included for Single-DIN installations
- Painted high gloss black to match factory finish



99-7380HG

N P D

HYUNDAI **Elantra GT 2016-2017** (with NAV)

- Pocket included for Single-DIN installations
- Painted high gloss black to match factory finish



99-7381

N P D

HYUNDAI **Santa Fe 2008-2009** (with NAV)

- Parts included for the installation of both Single-DIN and Double-DIN radios



Integrated electronics with laser-etched graphics retain climate control display features

99-7382HG *Turbo* **N P D**

KIA Niro 2017-2019 (without NAV)

- Parts included for the installation of both Single-DIN and Double-DIN radios
- Integrated electronics with laser-etched graphics retain climate control display features
- Painted to match the factory finish



95-7383 **N P D**

HYUNDAI Sonata 2018-2019

- Designed specifically for the installation of Double-DIN radios
- Painted to match the factory color and finish



99-7383 **N P**

HYUNDAI Sonata 2018-2019

- Includes parts for the installation of Single-DIN radios
- Painted to match the factory color and finish



Includes climate display for fan speed, mode, and temp, which was displayed on the factory radio

99-7384B *Turbo* **P D**

KIA Optima 2017-UP* (without NAV, with display radio) *Display radio is an Android Auto/Apple CarPlay radio

- Designed for both ISO Single-DIN (with pocket) and ISO Double-DIN installations
- Includes climate display for fan speed, mode, and temp, which was displayed on the factory radio
- Includes an AXSWC, AX-CAM6V, antenna adapter, and wiring harness for a complete installation
- Painted scratch-resistant matte black



HYUNDAI+KIA



Includes climate display for fan speed, mode, and temp, which was displayed on the factory radio

99-7385B



HYUNDAI **Santa Fe Sport 2017-2018** (without NAV)

- Designed for both ISO Single-DIN (with pocket) and ISO Double-DIN installations
- Includes climate display for fan speed, mode, and temp, which was displayed on the factory radio
- Includes an AXSWC, AX-CAM6V, and wiring harness for a complete installation
- Painted scratch-resistant matte black



Includes climate display for fan speed, mode, and temp, which was displayed on the factory radio

99-7386B



HYUNDAI **Santa Fe Sport 2013-2018** (with NAV)
(with factory navigation and auto climate controls)

- Designed for both ISO Single-DIN (with pocket) and ISO Double-DIN installations
- Includes climate display for fan speed, mode, and temp, which was displayed on the factory radio
- Includes an Axxess interface and wiring harnesses
- For factory amplified systems
- Includes an AX-CAM6V and antenna adapter
- Painted high gloss black



Includes climate display for fan speed, mode, and temp, which was displayed on the factory radio

99-7387HG



KIA **Soul 2017-2019** (without factory NAV or auto climate controls)

- Designed for both ISO Single-DIN (with pocket) and ISO Double-DIN installations
- Includes climate display for fan speed, mode, and temp, which was displayed on the factory radio
- Includes an AXSWC, AX-CAM6V, antenna adapter, and wiring harness for a complete installation
- Painted high gloss black



Includes climate display for fan speed, mode, and temp, which was displayed on the factory radio

99-7388HG



KIA **Soul 2014-2019** (with factory NAV)

- Parts included for the installation of both Single-DIN and Double-DIN radios
- Integrated electronics with laser etched graphics retain the factory climate control display features. Includes AXSWC to retain the factory steering wheel controls. Retains factory backup camera if equipped
- A gloss black housing with matte black controls to match the factory finish



Retains and controls most climate functions normally lost when removing factory radio

99-7389B



- KIA Sportage 2017-2019** (non-NAV display radio)
- Parts included for the installation of both Single-DIN and Double-DIN radios
 - Integrated electronics with laser etched graphics retain the factory climate control display features. Includes AXSWC to retain the factory steering wheel controls. Retains factory backup camera if equipped
 - Painted scratch-resistant matte black



Retains and controls most climate functions normally lost when removing factory radio

99-7390B



- KIA Sportage** (with NAV) **2017-2018**
- Designed for both ISO Single-DIN (with pocket) and ISO Double-DIN installations
 - Includes an AX-CAM6V, antenna adapter, and wiring harness for a complete installation

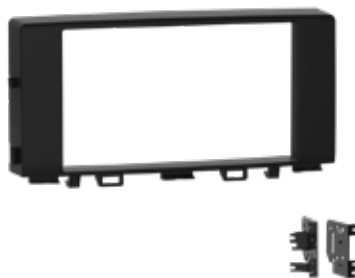

95-7391B



- KIA RIO 2018-UP***
- ISO Double-DIN radio provision
 - Painted scratch-resistant matte black



99-7391B



- KIA RIO 2018-UP***
- ISO Single-DIN provision with an included pocket
 - Painted scratch-resistant matte black



99-7392B



- HYUNDAI Kona 2018-UP***
- Designed for use with ISO Double-DIN radio with "L" shaped design, with the radio chassis at the bottom of the screen. As of this writing, only the Alpine INE-W967HD (discontinued, replaced by INE-W977HD), iLX-107, and iLX-207 have this design
 - Most Single-DIN radios can be installed using this kit
 - Painted scratch-resistant matte black



HYUNDAI + KIA + MAZDA



95-7393B



HYUNDAI Accent 2018-UP*

- Specific for Double-DIN installations
- Painted scratch-resistant matte black



99-7393B



HYUNDAI Accent 2018-UP*

- Specific for Single-DIN installations with a pocket
- Painted scratch-resistant matte black

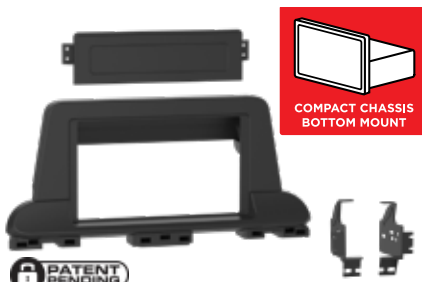

99-7394B



KIA Forte 2019-UP*

- Designed for most any Single-DIN radio
- Special design for ISO Double-DIN radio with an "L" shaped chassis design, with the radio chassis at the bottom of the screen
- Specifically Alpine INE-W967HD, INE-W977HD, iLX-107, and iLX-207 (refer to radio manufacturer for current models)
- Special brackets included for Pioneer modular radios, DMH-C2550NEX and DMH-C2500NEX (refer to radio manufacturer for current models)
- Painted scratch-resistant matte black

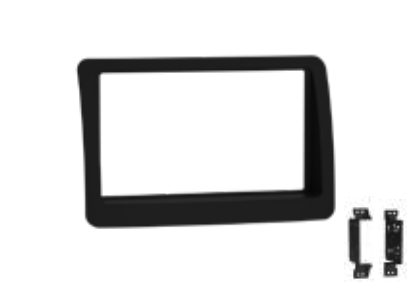

99-7395B



HYUNDAI Elantra Touring 2009-2012

- Parts included for both ISO Single-DIN and ISO Double-DIN installations
- Cutting template included to simplify modifying the factory dash panel
- Painted scratch-resistant matte black to match the factory finish

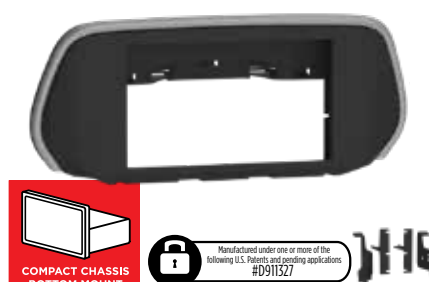

99-7396



HYUNDAI Santa Fe 2019-UP*

- Designed for most Single-DIN radios and a special design for ISO Double-DIN radios with an "L" shaped chassis design with the radio chassis at the bottom of the screen. Specifically Alpine INE-W967HD, INE-W977HD, iLX-107, and iLX-207 (refer to radio manufacturer for current models)
- Special brackets included for Pioneer modular radios DMH-C2550NEX and DMH-C2500NEX (refer to radio manufacturer for current models)
- Painted scratch-resistant matte black with a silver trim

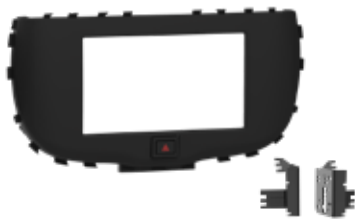

99-7397B



KIA Soul 2020-UP*

- Integrated circuit board + laser etched graphics on molded "hard button" to retain factory hazard functionality
- Includes radio harnessing and interfacing to retain factory steering wheel controls and factory backup camera
- Painted scratch-resistant matte black to match factory appearance
- Parts included for the installation of both Single-DIN and Double-DIN radios



95-7398



HYUNDAI Venue 2020-UP*

- ISO Double-DIN radio provision
- Most full-sized Double-DIN radios require minor sub-dash modifications
- Shallow mount radios will not require any modifications
- Housing is painted scratch-resistant matte black with separate molded vent trims being bright silver to match the factory appearance



MAZDA

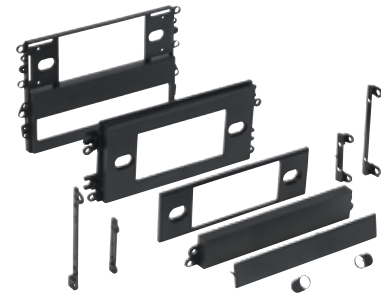

99-7500

MAZDA Multi-Kit 1986-1997** (dash bezel mount)

- Offers quick conversion from 2-shaft to Single-DIN
- Allows installation of 1/4" or 1/2" DIN equalizer

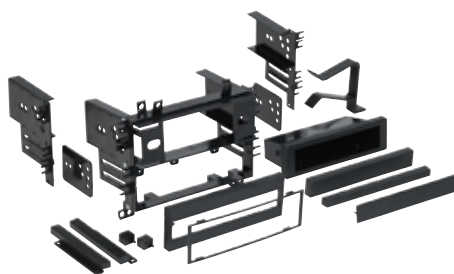

99-7501

- MAZDA Multi-Kit** 1984-1997** (sub-dash mount)
- Offers quick conversion from 2-shaft to Single-DIN
 - Specially designed for ISO mount radios with ISO trim ring
 - OEM-style pocket included
 - Allows installation of 1/4" or 1/2" DIN equalizer



95-7502B



- MAZDA MPV 2000-2006**
- Designed specifically for Double-DIN installations
 - Painted matte black to match the factory finish



99-7502

- MAZDA MPV 2000-2006**
- Recessed Single-DIN radio opening
 - ISO mount radio compatible using snap-in ISO radio mounts
 - Comes complete with built-in under radio pocket



95-7504



- MAZDA 3 2004-2009**
- Display replacement pocket included
 - Designed specifically for installation of Double-DIN radios



99-7504

- MAZDA 3 2004-2009**
- Factory display replacement pocket included
 - ISO mounts with Metra's patented quick-release brackets include a custom trim plate



99-7505



- MAZDA Multi-Kit** 1995-2006**
- Recessed Single-DIN opening with pocket
 - Double-DIN and/or two ISO mount radio trim included
 - Contoured to match factory dash



99-7506



- MAZDA MX-5 Miata 2006-2008**
- Designed specifically for Single-DIN & Double-DIN
 - Metra's patented quick release snap-in ISO mounting system with ISO trim ring
 - Allows retention of factory climate controls in their original location
 - Painted matte black



99-7508



- MAZDA CX-7 2007-2009**
- Metra's patented quick release snap-in ISO mounting system with ISO trim ring
 - Removable oversized storage pocket with built-in radio supports Single-DIN and Double-DIN



99-7509



- MAZDA 5 2006-2010** (excluding OE NAV models)
- Designed for either Single-DIN or Double-DIN installations
 - Metra's patented quick release snap-in ISO mounting system with ISO trim ring
 - Painted silver, contoured and textured to compliment factory dash

MAZDA



- Includes interface
- Retains functionality of factory HVAC controls and upper display
- Put your own text on the display

95-7510 *Turbo*



MAZDA RX-8 2004-2008

- Designed specifically for installation of Double-DIN radios
- ISO mounts with Metra's patented Quick-Release brackets include a custom trim plate
- Custom design allows retention of factory hazard button in its original location
- Contoured and textured to match factory dash
- Painted to match matte black factory color and texture
- Comprehensive instruction manual including step-by-step disassembly and assembly
- Now works with auto climate control models



- Includes interface
- Retains functionality of factory HVAC controls and upper display
- Put your own text on the display

99-7510 *Turbo*



MAZDA RX-8 2004-2008

- Designed specifically for the installation of a Single-DIN radio with included storage pocket
- ISO mounts with Metra's patented Quick-Release brackets include a custom trim plate
- Custom design allows retention of factory hazard button in its original location
- Provides a recessed Single-DIN mount with a molded pocket
- Contoured and textured to match factory dash
- Painted to match matte black factory color and texture
- Comprehensive instruction manual including step-by-step disassembly and assembly
- Now works with auto climate control models



- Includes interface
- Retains functionality of factory HVAC controls and upper display
- Put your own text on the display

95-7510HG *Turbo*



MAZDA RX-8 2004-2008

- Designed specifically for installation of Double-DIN radios or two Single-DIN radios
- ISO mounts with Metra's patented Quick-Release brackets include a custom trim plate
- Contoured and textured to match factory dash
- Custom design allows retention of factory hazard button in its original location
- Painted to match high gloss black factory color and texture
- Comprehensive instruction manual including step-by-step disassembly and assembly
- Now works with auto climate control models



- Includes interface
- Retains functionality of factory HVAC controls and upper display
- Put your own text on the display

99-7510HG *Turbo*



MAZDA RX-8 2004-2008

- Designed specifically for the installation of a Single-DIN radio
- ISO mounts with Metra's patented quick-release brackets include a custom trim plate
- Custom design allows retention of factory hazard button in its original location
- Provides a recessed Single-DIN mount with a molded pocket
- Contoured and textured to match factory dash
- Painted to match high gloss black factory color and texture
- Comprehensive instruction manual including step-by-step disassembly and assembly
- Now works with auto climate control models



99-7511S



MAZDA 6 2009-2013

- Includes parts for Single-DIN and Double-DIN installations
- Contoured and textured to match factory dash
- Painted silver to match OEM factory finish



99-7514B



MAZDA 3 2010-2013

- For both Single-DIN and Double-DIN installations
- Painted matte black to match dash
- Available in high gloss black as 99-7514HG



99-7515B



MAZDA RX-8 2009-2011

- For both Single-DIN and Double-DIN installations
- Painted matte black to match factory dash



99-7515HG



MAZDA RX-8 2009-2011

- For both Single-DIN and Double-DIN installations
- Painted high gloss to match factory dash



99-7516B



MAZDA CX-9 2007-2015

- Designed for both Single-DIN and Double-DIN installations
- Painted a scratch-resistant matte black to match factory dash



99-7517S



MAZDA BT-50 2006-2010 (not North American)

- Designed for Single-DIN or Double-DIN radio installations
- Retains factory climate controls
- Painted silver to match factory finish



99-7518B



MAZDA 2 2007-2014

- For both Single-DIN and Double-DIN installations
- Painted matte black to match factory finish



99-7519B



MAZDA MX-5 Miata 2009-2015

International Multi-Kit 2007-UP*

- Double-DIN and Single-DIN radio provision
- Painted matte black to match factory finish



99-7520B



MAZDA CX-7 2010-2012

- Double-DIN and Single-DIN radio provision
- Painted matte black to match factory finish

MAZDA



95-7521B



MAZDA 5 2012-2015

- Specifically designed for installation of Double-DIN radios
- Painted scratch-resistant matte black to match the factory color and finish



99-7521B



MAZDA 5 2012-2015

- Oversized storage pocket included for Single-DIN radio installations
- Painted scratch-resistant matte black to match the factory color and finish



95-7522B



MAZDA CX-5 2013-2016

CX-5 Sport 2016 6 2014-2015

- Designed specifically for Double-DIN installations
- Painted scratch-resistant matte black to match the factory color and finish



99-7522B



MAZDA CX-5 2013-2015 | CX-5 Sport 2016 6 2014-2015

- Pocket included for Single-DIN installations
- Painted scratch-resistant matte black to match the factory color and finish

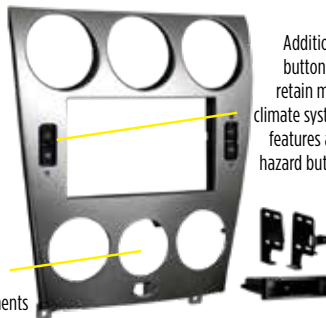

Retains factory climate components

Additional buttons to retain most climate system features and hazard button

99-7523S Turbo



MAZDA 6 2003-2005

- Electronics and soft touch buttons now allow for Double-DIN installs
- Compatible with manual and auto climate systems
- Painted silver to match the factory color and finish

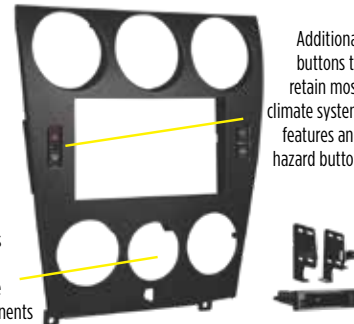

Retains factory climate components

Additional buttons to retain most climate system features and hazard button

99-7524B Turbo



MAZDA 6 2006-2008

- Electronics and soft touch buttons now allow for Double-DIN installs
- Compatible with manual and auto climate systems
- Painted black to match the factory color and finish



99-7525S



MAZDA 5 2008-2010 (with NAV)

- Designed for the installation of both Single-DIN and Double-DIN radios
- Painted silver to match the factory finish



95-7526B



MAZDA 3 2014-2018

- Designed to be used with an ISO Double-DIN radio with an "L" shaped chassis design, with the radio chassis at the bottom of the screen
- Painted black to match the factory finish



99-7526B



MAZDA 3 2014-2018

- For the installation of Single-DIN radios
- Painted black to match the factory finish



Manufactured under one or more of the following U.S. Patents and/or pending applications: #D873769



Manufactured under one or more of the following U.S. Patents and/or pending applications: #D873091



99-7527S



MAZDA 5 2006-2007 (with NAV)

- Designed for the installation of both Single-DIN and Double-DIN radios
- Painted silver to match the factory finish



98-7599

MAZDA TurboPocket

- Trim ring blends the pocket to the dash

MITSUBISHI

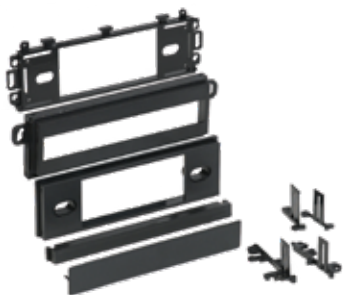

99-7000

PLYMOUTH | DODGE | EAGLE
MITSUBISHI Imports 1985-1996

- Allows pocket retention
- Includes snap-in center bar when replacing factory Double-DIN radio
- Provision allows installation of 1/4 or 1/2 DIN equalizer - Includes EQ side supports

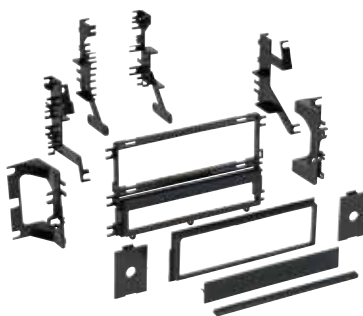

99-7001

MITSUBISHI Multi-Kit** 1990-2005

- Comes with 1/2 DIN EQ provision



99-7006

MITSUBISHI Eclipse | EAGLE Talon
1995-1999

- Quick conversion from 2-shaft to Single-DIN



99-7007

MITSUBISHI Eclipse 2000-2005
Montero Sport 2000-2004

- Recessed Single-DIN opening
- Mounts through the dash for a custom flush look



99-7008

MITSUBISHI Outlander 2003-2006

- Recessed Single-DIN radio opening
- Metra's patented quick release snap-in ISO mounting system with ISO trim ring
- Comes complete with built-in under radio pocket



99-7009

MITSUBISHI Endeavor 2004-2011

- Metra's patented quick release snap-in ISO mounting system with ISO trim ring
- Recessed Single-DIN mount
- Replaces factory pocket below radio



MITSUBISHI



99-7010



MITSUBISHI Eclipse 2006-2012

- Designed for Single-DIN and Double-DIN installations with included removeable oversized storage pocket with built-in radio supports
- Metra's patented quick release snap-in ISO mounting system with ISO trim ring
- Allows retention of factory climate controls in their original location



Texture with color matched paint to match factory finish

99-7011



MITSUBISHI Lancer 2008-2017

- Designed for Single-DIN and Double-DIN installations with included removeable oversized storage pocket with built-in radio supports
- Metra's patented quick release snap-in ISO mounting system with ISO trim ring
- Allows retention of factory climate controls in their original location



99-7012



MITSUBISHI Galant 2004-2012

- (with auto climate controls)
- Parts provided for Single-DIN and Double-DIN installations
 - Metra's patented quick release snap-in ISO mounting system with ISO trim ring
 - Retains factory hazard button, passenger seatbelt and passenger airbag status lights in their original location



Textured with color matched paint to match factory finish

99-7013TB



MITSUBISHI Outlander 2007-2013

- Designed for ISO Single-DIN installations with pocket or Double-DIN installations without pocket
- OEM matched texture with paint

Circuit board included



99-7014B



MITSUBISHI Outlander Sport 2011-2013

- Retains factory hazard button and passenger airbag light
- Parts included for Single-DIN and Double-DIN installations
- Painted matte black to match the factory finish
- Also works with ASX internationally
- Available painted gloss black 99-7014HG



95-7015CHG



MITSUBISHI Outlander 2014-UP*

- Designed for Double-DIN installations
- Painted a custom high gloss charcoal
- Use a 70-7005 or MITO-03 harness (sold separately) for a complete installation





99-7015CHG



MITSUBISHI Outlander 2014-UP*

- Pocket included for Single-DIN installations
- Painted a custom high gloss charcoal
- Use a 70-7005 or MITO-03 harness (sold separately) for a complete installation



95-7016GHG



MITSUBISHI Mirage 2014-2017 | Mirage G4 2017 (without OE NAV)

- Specifically designed for Double-DIN installations
- Built to match the factory color and finish



99-7016GHG



MITSUBISHI Mirage 2014-2017 (without NAV)
Mirage G4 2017 (without 7" touchscreen)

- Pocket included for Single-DIN installations
- Built to match the factory color and finish



95-7017B



MITSUBISHI Lancer 2002-2007

- Designed specifically for Double-DIN radio installations with included brackets and a panel to relocate the factory climate control
- Painted scratch-resistant matte black



95-7018CHG



MITSUBISHI Outlander Sport 2014-2019

- Designed specifically for Double-DIN installations
- Painted scratch-resistant charcoal high gloss to match the factory color and appearance



99-7018CHG



MITSUBISHI Outlander Sport 2014-2019

- A pocket is included for Single-DIN installations
- Painted scratch-resistant charcoal high gloss to match the factory color and appearance



95-7018B



MITSUBISHI Outlander Sport 2014-2019

- Designed specifically for Double-DIN installations
- Painted scratch-resistant matte black to match the factory color and appearance



99-7018B



MITSUBISHI Outlander Sport 2014-2019

- A pocket is included for Single-DIN installations
- Painted scratch-resistant matte black to match the factory color and appearance

MITSUBISHI+INFINITI

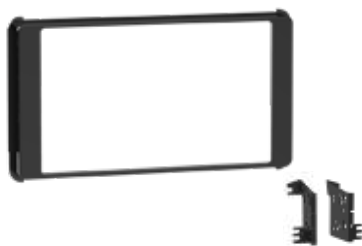

95-7019

MITSUBISHI **Mirage** | **Mirage G4 2018-2020**

- ISO Double-DIN radio provision
- High polished processing gives a gloss plastic to match the look of both the aftermarket radio and factory finish



99-7019

MITSUBISHI **Mirage** | **Mirage G4 2018-2020**

- ISO Single-DIN radio provision with a pocket
- High polished processing gives a gloss plastic to match the look of both the aftermarket radio and factory finish



95-7020

MITSUBISHI **Eclipse Cross ES 2018-2020**

- ISO Double-DIN radio provision
- High polished processing gives a gloss plastic to match the look of both the aftermarket radio and factory finish



99-7020

MITSUBISHI **Eclipse Cross ES 2018-2020**

- ISO Single-DIN radio provision with a pocket
- High polished processing gives a gloss plastic to match the look of both the aftermarket radio and factory finish



98-8999

MITSUBISHI | SUBARU | VOLKSWAGEN

Under-Radio Pocket 1991-2008

- Allows a Single-DIN or ISO mount radio installation in a Double-DIN opening
- Fits under radio and matches factory opening perfectly



Quick access to Metra's parts, specs, products info and more! Download it **FREE**

INFINITI

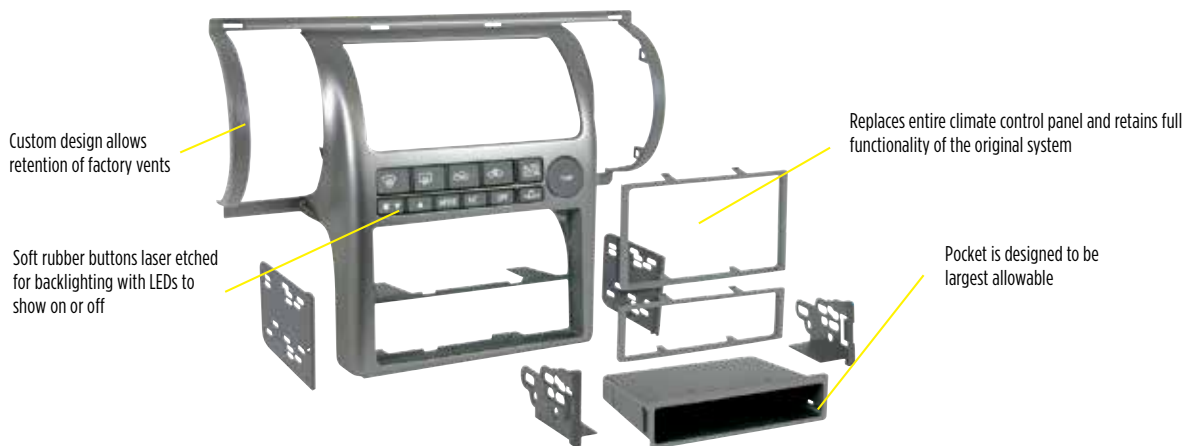

Custom design allows retention of factory vents

Soft rubber buttons laser etched for backlighting with LEDs to show on or off

Replaces entire climate control panel and retains full functionality of the original system

Pocket is designed to be largest allowable

99-7604 Turbo



INFINITI **G35 2003-2004** (without NAV)

- Replaces entire climate control panel
- Retains full functionality of the HVAC system
- Custom design allows retention of the factory air vents in their original location
- Recessed DIN opening
- Metra's patented quick release snap-in ISO mounting system with ISO trim ring
- Double-DIN radio trim included

- Contoured to match factory dash
- Comes with oversized storage pocket
- High-grade ABS plastic
- Comprehensive instruction manual
- All necessary hardware included for easy installation
- Painted silver to match OEM color and finish



N **P** **D**
NEW PAINTED TEXTURED DOUBLE-DIN

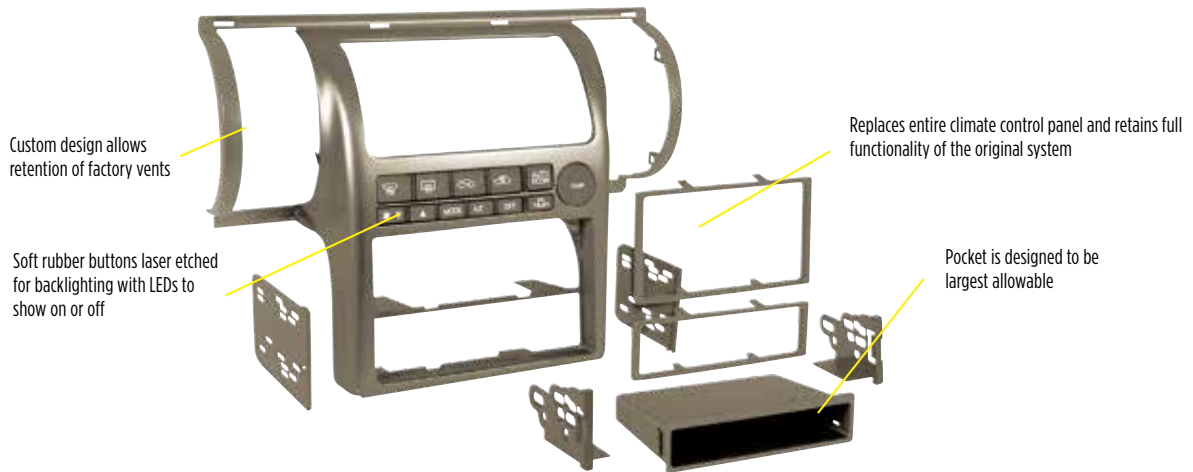

99-7604T *Turbo*



INFINITI G35 2003-2004 (without NAV)

- Replaces entire climate control panel
- Retains full functionality of the HVAC system
- Custom design allows retention of the factory air vents in their original location
- Recessed DIN opening
- Metra's patented quick release snap-in ISO mounting system with ISO trim ring
- Double-DIN radio trim included
- Contoured to match factory dash
- Comes with oversized storage pocket
- High-grade ABS plastic
- Comprehensive instruction manual
- All necessary hardware included for easy installation
- Painted tan to match OEM color and finish

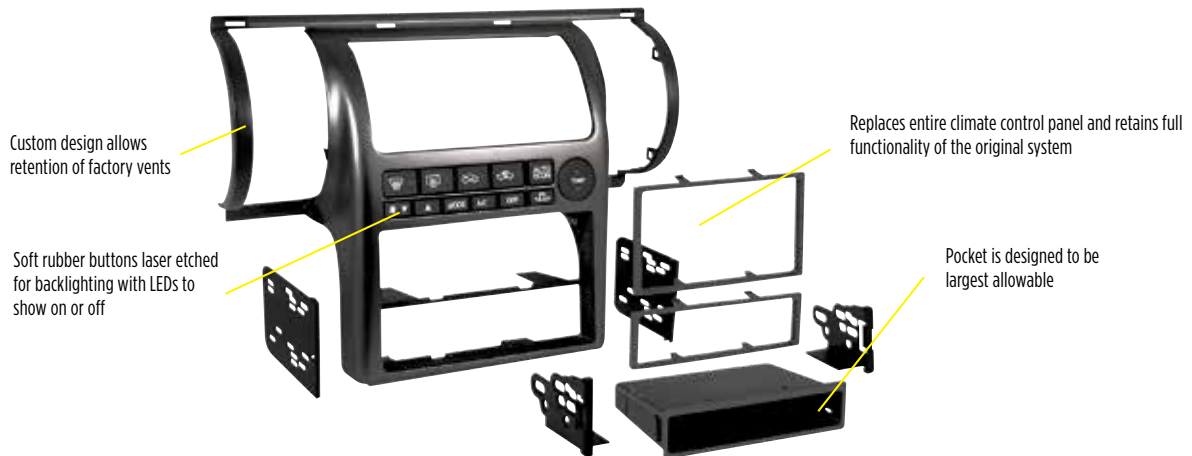

99-7604B *Turbo*



INFINITI G35 2003-2004 (without NAV)

- Replaces entire climate control panel
- Retains full functionality of the HVAC system
- Custom design allows retention of the factory air vents in their original location
- Recessed DIN opening
- Metra's patented quick release snap-in ISO mounting system with ISO trim ring
- Double-DIN radio trim included
- Contoured to match factory dash
- Comes with oversized storage pocket
- High-grade ABS plastic
- Comprehensive instruction manual
- All necessary hardware included for easy installation
- Painted black to match OEM color and finish

INFINITI

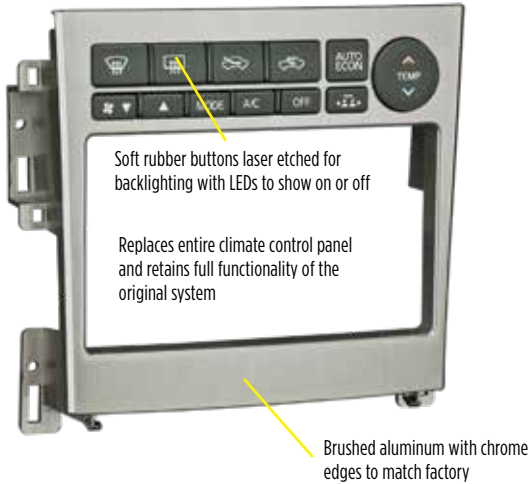

95-7605A Turbo  

INFINITI **G35 Sedan 2005-2006** | **G35 Coupe 2005-2007** (without NAV)

- Now with a brushed aluminum finish to match factory finish
- Replaces entire climate control panel
- Retains full functionality of the HVAC system
- Recessed DIN opening
- ISO mount only
- Double-DIN radio trim included
- High-grade ABS plastic
- Comprehensive instruction manual
- All necessary hardware included for easy installation
- Also available in silver, 95-7605



99-7605A Turbo 

INFINITI **G35 Sedan 2005-2006** | **G35 Coupe 2005-2007** (without NAV)

- Now with a brushed aluminum finish to match factory finish
- Replaces entire climate control panel
- Retains full functionality of the HVAC system
- Custom design allows retention of the factory air vents in their original location
- Recessed DIN opening
- ISO mount only
- Comes with oversized storage pocket
- High-grade ABS plastic
- Comprehensive instruction manual
- All necessary hardware included for easy installation
- Also available in silver, 95-7605



99-7609G  

INFINITI **I30 2000-2001** | **I35 2002-2004**

- Double-DIN radio provision with included pocket for Single-DIN installations
- ISO stacked radio provision
- Painted gray to match factory dash



99-7625B Turbo  

INFINITI **G25 Sedan 2011-2012** | **G35 Sedan 2007-2008**
G37 Sedan 2008-2013 (without NAV, with auto climate controls)

- Included interface with new technology
- Pocket included for Single-DIN installations
- Painted scratch-resistant matte black

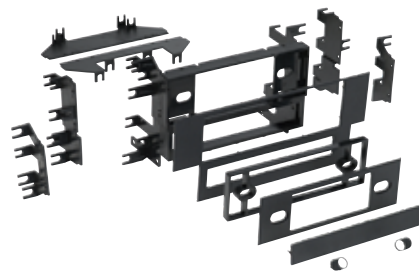

99-7401

NISSAN Multi-Kit 1984-1997**

- Professional Installer Series TurboKit offers quick conversion from 2-shaft to Single-DIN
- Allows the installation of 1/2 DIN equalizer



99-7402

NISSAN 350Z 2003-2005

- For Single-DIN and Double-DIN radios
- Metra's patented quick release snap-in ISO mounting system with ISO trim ring



99-7403

NISSAN Pathfinder 2003-2004 (LE models)

- INFINITI QX4 2001-2003 (non-NAV)**
- Provides pocket with recessed mounting of a Single-DIN radio or an ISO DIN radio using Metra's patented ISO Quick-Release bracket



99-7404

NISSAN Maxima 2004-2006

- ISO mount only
- Retains factory A/C controls and pocket
- Painted silver and contoured to match factory dashboard color and texture



95-7404S

NISSAN Maxima 2004-2006

- Double-DIN radio provision
- ISO mount only
- Painted silver and contoured to match factory dashboard color and texture



95-7405

NISSAN Titan 2004-2015 (S Trim)

- (without dual zone climate controls)
- Designed specifically for Double-DIN radios
 - Does not require the factory brackets



99-7405

NISSAN Titan 2004-2015 (S Trim)

- (without dual zone climate controls)
- Comes with oversized under-radio storage pocket
 - Snap-in support system with trim plate

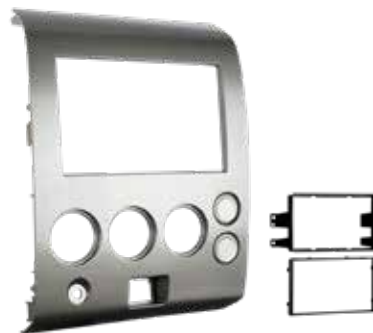

95-7406

NISSAN Armada 2004-2005 | Titan 2004-2007

- (without dual zone climate controls and factory NAV)
- Double-DIN specific
 - Painted and contoured to match factory dash



99-7406

NISSAN Armada 2004-2005 | Titan 2004-2007

- (without dual zone climate controls and factory NAV)
- Metra's patented Snap-In ISO Support System
 - Recessed Single-DIN opening
 - Painted and contoured to match factory dash

NISSAN



99-7409

NISSAN Maxima | 240SX 1995-1999

- Quick conversion from 2-shaft to Single-DIN
- Designed to mount precisely to the OEM radio mounting positions
- Allows the installation of 1/2 DIN equalizer
- High-grade ABS plastic



99-7410

NISSAN Sentra | 200SX 1995-1999

- Quick conversion from 2-shaft to Single-DIN
- Allows the installation of 1/2 DIN equalizer

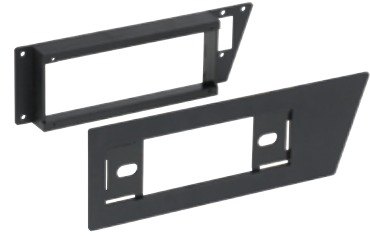

99-7411

NISSAN 300ZX 1984-1989

- Professional Installer Series TurboKit offers quick conversion from 2-shaft to Single-DIN
- Mounting trim plate accommodates power antenna switch

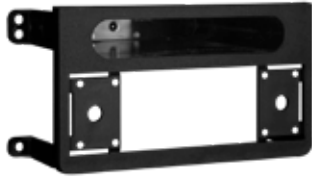

99-7412

NISSAN Quest | MERCURY Villager 1993-1998

- Easy conversion from 2-shaft to Single-DIN
- Pocket holds two CD jewel cases



99-7413

NISSAN Altima 1993-2001

- Recessed for Single-DIN applications
- Equalizer trim plate included for times when no EQ is installed



99-7414

NISSAN Sentra 2000-2006

- Accommodates ISO Single-DIN radios
- Contoured to match factory dashboard

Color matched paint to match factory finish



99-7414G



NISSAN Sentra 2000-2006

- Accommodates ISO Single-DIN radios
- Contoured to match factory dashboard



99-7415

MERCURY Villager 1999-2002

- NISSAN Quest 1999-2003
- Recessed for Single-DIN mount applications
 - Accommodates two CD jewel cases in pocket

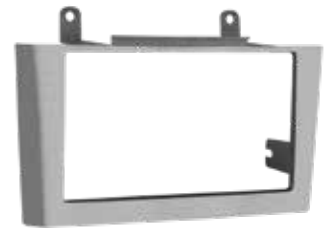

95-7416G



NISSAN Maxima 2000-2003 (equipped with

- Bose or Comfort and Convenience Packages)
- Double-DIN radio provision
 - Painted gray to match factory dash



99-7416

NISSAN **Maxima 2000-2003** (equipped with Bose or Comfort and Convenience Packages)

- Recessed for Single-DIN mount applications
- Accommodates two CD jewel cases in pocket



95-7417

NISSAN **Multi-Kit** 1993-2004**

- Designed specifically for the installation of Double-DIN radios



99-7417

NISSAN **Multi-Kit** 1993-2004**

- For ISO and Single-DIN mount applications
- Accommodates two CD jewel cases in pocket



95-7418

NISSAN **Altima 2002-2004**

- Designed specifically for the installation of Double-DIN radios
- New version now includes radio brackets



99-7418

NISSAN **Altima 2002-2004**

- Provides pocket with recessed mounting of an ISO Single-DIN radio

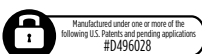

95-7419

NISSAN **Altima 2005-2006** (without NAV)

- Designed specifically for the installation of Double-DIN radios



99-7419

NISSAN **Altima 2005-2006** (without NAV)

- Recessed Single-DIN opening
- Metra's patented Snap-In ISO Support System

Separate housing and trim allow DIN and ISO mount with a flush, tight finish



99-7421

NISSAN **Maxima 2007-2008** (without NAV)

- Metra's patented quick release snap-in ISO mounting system with ISO trim ring
- For Single-DIN and Double-DIN installations
- Elaborate bracket set provides support for OE display and modules and allows installation without the use of the factory brackets

Separate housing and trim allow DIN and ISO mount with a flush, tight finish



99-7422

NISSAN **Sentra 2007-2012** (without pocket door)

- Metra's patented quick release snap-in ISO mounting system with ISO trim ring
- For Single-DIN and Double-DIN installations
- Elaborate bracket set provides support for OE display and modules and allows installation without the use of the factory brackets

NISSAN

99-7423

NISSAN Altima 2007-2013

- Two trim plates allows the retention of either OEM climate control system
- Metra's patented quick release snap-in ISO mounting system with ISO trim ring
- Designed for Single-DIN or Double-DIN installations

95-7424

NISSAN Titan 2008-2012

- Custom design allows the retention of the factory climate controls and passenger airbag light in their original location
- Designed specifically for installation of Double-DIN radios
- Painted silver to match factory dash

99-7424

NISSAN Titan 2008-2012

- Custom design allows the retention of the factory climate controls and passenger airbag light in their original location
- Metra's patented quick release snap-in ISO mounting system with ISO trim ring
- Painted silver to match factory dash

95-7425

NISSAN Rogue 2008-2010

- Designed specifically for installation of Double-DIN radios

99-7425

NISSAN Rogue 2008-2010

- Metra's patented quick release snap-in ISO mounting system with ISO trim ring
- Recessed Single-DIN opening

99-7426

NISSAN Murano 2009-2014

- (not for BOSE or NAV equipped vehicles)
- Climate controls must be above the factory radio
 - Includes parts for installation of Single-DIN or Double-DIN radios
 - Metra's patented quick release snap-in ISO mounting system with ISO trim ring
 - Painted black to match factory finish

95-7427G

NISSAN Maxima 2009-2014

- (not for models with factory NAV or tech. package)
- Designed specifically for the installation of Double-DIN radios
 - Designed with a molded pocket for Single-DIN installations
 - Painted gray over a custom texture to match OEM factory finish
 - Also available in matte black 95-7427B

99-7427B

NISSAN Maxima 2009-2014

- (not for models with factory NAV or tech. package)
- High-grade ABS plastic contoured and textured to compliment factory dash
 - Built-in oversized storage pocket
 - Painted matte black over a custom texture to match OEM factory finish
 - Also available in gray 99-7427G



99-7428B



NISSAN **Frontier LE | Pro-4X | SE with V6 2009-2011**
Frontier excludes S trims **2012 | Xterra S 2009-2012**
Offroad | SE 2009-2011 | Xterra Pro 4X 2012
 SUZUKI **Equator Crew Cab 2009-2011**

- Single-DIN and Double-DIN radios
- Painted matte black to match factory finish



99-7428G



NISSAN **Frontier LE | Pro-4X | SE with V6 2009-2011**
Frontier excludes S trims **2012 | Xterra S 2009-2012**
Offroad | SE 2009-2011 | Xterra Pro 4X 2012
 SUZUKI **Equator Crew Cab 2009-2011**

- Single-DIN and Double-DIN radios
- Painted gray to match factory finish



99-7477

NISSAN **Hardbody | Pathfinder 1986-1993**

- Quick conversion from 2-shaft to Single-DIN with snap-in style shaft supports
- Recessed for Single-DIN applications



99-7578

NISSAN **Hardbody 1994-1997**
Pathfinder 1994-1995

- Kit has built-in EQ supports
- Radio support is provided from our patented "Side Arm Support System™"



99-7579

NISSAN **Pathfinder 1996-2000**

- Recessed mount for Single-DIN radios
- Radio side support is provided by our patented "Side Arm Support System™"
- Allows the installation of 1/2 DIN equalizer



99-7580

NISSAN **Frontier 1998-2001**
Xterra 2000-2001

- Allows the installation of 1/2 DIN equalizer with supports



99-7581



NISSAN **Frontier 2005-2015 | Pathfinder 2005-2012 | Xterra 2009**
 SUZUKI **Equator 2009**

- Recessed Single-DIN opening
- Metra's patented quick release snap-in ISO mounting system with ISO trim ring
- For Single-DIN and Double-DIN installations



99-7602



NISSAN **350Z 2006-2008**

- Metra's patented quick release snap-in ISO mounting system with ISO trim ring
- Double-DIN radio trim included



95-7603



NISSAN **Multi-Kit** 2007-2017**

- Specific for Double-DIN installations
- Utilizes factory brackets for a complete install

NISSAN

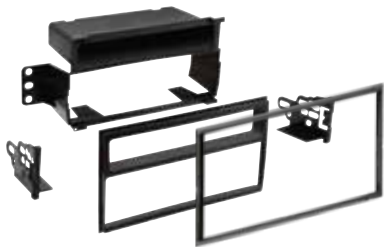

99-7603



NISSAN Versa 2007-2011

- Metra's patented quick release snap-in ISO mounting system with ISO trim ring
- Double-DIN radio trim included



99-7606



NISSAN Titan | Armada 2006-2007

- (with dual zone climate control and without factory NAV)
- Parts included for Single-DIN and Double-DIN installations
- Metra's patented quick release snap-in ISO mounting system with ISO trim ring
- Painted and contoured to match factory dash



99-7607B



NISSAN 370Z 2009-UP* (excluding OE NAV models)

- Single-DIN and Double-DIN radio provision
- Painted a scratch-resistant matte black to match factory dash



99-7608



NISSAN Cube 2009-2014

- Parts included for Single-DIN and Double-DIN installations



99-7610B



NISSAN Juke 2011-2014 | Versa 2007-2011

- Parts included for Single-DIN and Double-DIN installations
- Painted matte black



99-7610HG



NISSAN Juke 2011-2014 | Versa 2007-2011

- Parts included for Single-DIN and Double-DIN installations
- Painted high gloss black

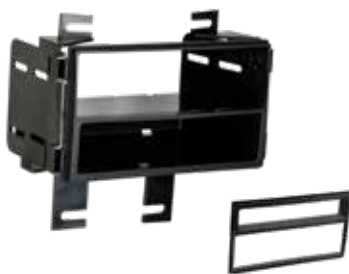

99-7611



NISSAN Rogue 2011-2013 (excluding SV and S with Special Edition models) | **Rogue Select**

- 2014-2015** (without 4.3 inch color display)
- Parts included for installation of Single-DIN and Double-DIN radios

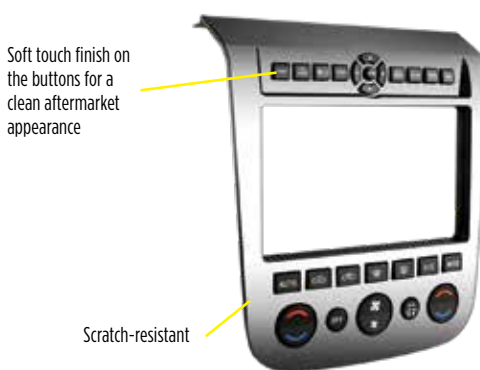

Replaces climate control panel and retains full functionality



99-7612A Turbo



NISSAN Murano 2003-2007

- Pocket included for Single-DIN installations
- Soft touch finish on the buttons for a clean aftermarket appearance
- Rubber buttons for control of climate controls and Driver Information Center
- Brushed aluminum finish to match factory radios



Soft touch finish on the buttons for a clean aftermarket appearance

Scratch-resistant



Replaces climate control panel and retains full functionality



99-7612B *Turbo*



NISSAN Murano Kit 2003-2007

- Pocket included for Single-DIN installations
- Soft touch finish on the buttons for a clean aftermarket appearance
- Rubber buttons for control of climate controls and Driver Information Center
- Painted black to match factory radios



99-7613



Manufactured under one or more of the following U.S. Patents and pending applications #D704697



NISSAN Juke 2011-2014 Rogue 2011 Rogue S | Rogue SV (with SL package) 2012-2013 Rogue Select (with lower model radio) 2014-2015 Versa 2007-2013 | Versa S | S+ | SV Base 2014

- Nissan Multi-Kit** for select 07-15 Nissan models
- For installation of DIN and Double-DIN aftermarket radios
- Multiple mounting tabs cover many new model Nissan vehicles



99-7614



NISSAN NV 2012-2014 | NV 2015-2017 (without OE NAV) Quest 2011-2012 (without OE NAV)

- Designed for installation of Single-DIN and Double-DIN aftermarket radios



99-7616



NISSAN Rogue S 2012-2013 (special edition package) | Rogue SV 2012-2013 | Rogue Select 2014-2015 (with upper model radio)

- Parts included for mounting of Single-DIN and Double-DIN radios



Manufactured under one or more of the following U.S. Patents and pending applications #D757707

95-7617B / 99-7617B



NISSAN Altima 2016-2018

- 95 - Designed for Double-DIN installations
- 99 - Pocket included for Single-DIN installations
- Painted scratch-resistant matte black to match the factory finish



95-7617GHG / 99-7617GHG



NISSAN Altima 2013-2015

- 95 - Designed for Double-DIN installations
- 99 - Pocket included for Single-DIN installations
- Painted high gloss gray to match the factory finish



95-7618G



NISSAN Sentra 2013-2019

- Designed specifically for Double-DIN installations
- Painted scratch-resistant gray to match the factory finish



99-7618G



NISSAN Sentra 2013-2019

- Pocket included for Single-DIN installations
- Painted scratch-resistant gray to match the factory finish



NISSAN



95-7619



NISSAN **Titan 2013-2015** | **Frontier 2013-2017**

Xterra 2013-2015 (with 4.3" display)

- Designed for Double-DIN installations
- Includes a textured trim
- Use 70-7552 harness and 40-N112 antenna adapter for a complete installation (sold separately)

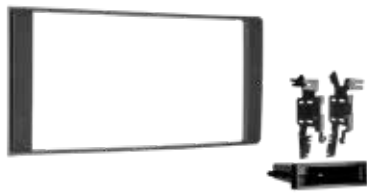

99-7619



NISSAN **Titan 2013-2015** | **Frontier 2013-2017**

Xterra 2013-2015 (with 4.3" display)

- Pocket included for Single-DIN installations
- Includes a textured trim
- Use 70-7552 harness and 40-N112 antenna adapter for a complete installation (sold separately)



Integrated rubber buttons for control of climate system and personalization menus

Includes interface!



99-7620B Turbo



NISSAN **Armada 2008-2012** | **Armada 2013-2015** (without NAV) | **Pathfinder 2008-2012**

- Parts included for installation of Single-DIN or Double-DIN radios
- Includes interface to retain use of factory LCD screen and integrates aftermarket radio with the factory sound system
- Integrated rubber buttons for control of climate system and personalization menus (lighting, locks, trip info, etc.)
- Use 40-N112 antenna adapter for a complete installation (sold separately)



95-7621



NISSAN **Versa SL/SV 2014** | **Versa 2015-2019** | **Versa Note 2014-2019**

- Specific for Double-DIN installations



99-7621

NISSAN **Versa SL/SV 2014** | **Versa 2015-2019** | **Versa Note 2014-2019**

- Pocket included for Single-DIN installations



95-7622HG



NISSAN **Rogue 2014-UP***
Rogue Sport 2017-UP*

- Designed specifically for Double-DIN installations
- Painted to match the factory color and finish



99-7622HG



NISSAN **Rogue 2014-UP***
Rogue Sport 2017-UP*

- Pocket included for Single-DIN installations
- Painted to match the factory color and finish





95-7623



NISSAN NV200 2013-UP*

- Specific for Double-DIN installations

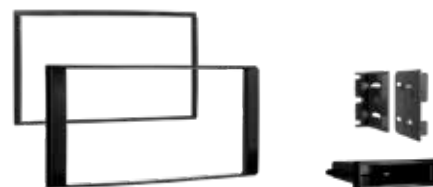

99-7623

NISSAN NV200 2013-UP*

- Pocket included for Single-DIN installations



95-7624



NISSAN Multi-Kit 2007-UP***

- Specific for Double-DIN installations



99-7624

NISSAN Multi-Kit 2007-UP***

- Pocket included for Single-DIN installations



99-7626HG



NISSAN Pathfinder 2013-2016

(without auto climate or NAV)

- Designed for Single-DIN or Double-DIN installations
- Built and painted in multiple colors to match the factory color and appearance



99-7627HG *Turbo*



NISSAN Pathfinder 2013-2016 (with auto A/C and without NAV)

- Designed for both Single-DIN or Double-DIN installations
- Built and painted in multiple colors to match the factory color and appearance
- Integrated circuit boards and buttons retain climate controls and driver customization menus



95-7628BHG



NISSAN Murano 2015-UP*

- Designed specifically for Double-DIN installations
- Painted high gloss to match the factory color and finish



99-7628BHG



NISSAN Murano 2015-UP*

- Pocket is included for Single-DIN installations
- Painted high gloss to match the factory color and finish

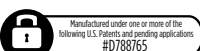

99-7629S



NISSAN Armada | Titan 2004-2007 (with factory NAV)

- Designed for installation of both ISO Single-DIN and ISO Double-DIN radios
- Painted to match the factory dash panel



NISSAN

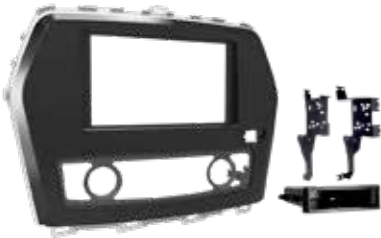

99-7630



NISSAN Maxima 2016-UP*

- Designed for the installation of Single-DIN and Double-DIN radios
- Provision to retain the factory climate controls and passenger airbag indicator
- Built-in multiple pieces to provide the final part in several different colors - Gloss charcoal, with silver trim and matte black insert for climate controls

Manufactured under one or more of the following U.S. Patents and pending applications: #D788763



95-7631B



NISSAN Titan 2017-2019 | Titan XD 2016-2019

- Specifically designed for Double-DIN installations
- Painted scratch-resistant matte black



99-7631B



NISSAN Titan 2017-2019 | Titan XD 2016-2019

- Pocket included for Single-DIN installations
- Painted scratch-resistant matte black



Driver customization control panel

99-7633 Turbo



NISSAN MAXIMA 2009 (with NAV or Tech package) **2010-2014** (Tech package only)

- Includes Axxess interface and wiring
- Integrated circuit boards and buttons retain climate controls and most personalization features as well as retaining factory backup camera
- Designed for both Single-DIN or Double-DIN installations
- Painted gloss black to match the factory finish



95-7634B



NISSAN NP300 2017-UP*

- Designed for Double-DIN installations
- Use 99-7634B for Single-DIN installations
- Can be used in models with or without a factory radio
- Painted scratch-resistant matte black

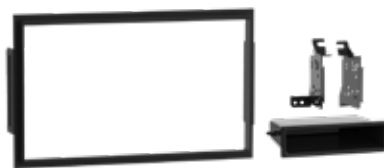

99-7635



NISSAN 2005-2015 | SUZUKI Equator 2009

- ISO Single-DIN radio provision with pocket
- ISO Double-DIN radio provision
- A version of the 99-7581 which no longer requires the factory brackets for Double-DIN installations



95-7636B



NISSAN Kicks 2018-UP*

- Designed specifically for Double-DIN installations
- Painted scratch-resistant matte black to match the factory finish

Manufactured under one or more of the following U.S. Patents and pending applications: #D878358



99-7636B



NISSAN Kicks 2018-UP*

- Pocket included for Single-DIN installations
- Painted scratch-resistant matte black to match the factory finish

Manufactured under one or more of the following U.S. Patents and pending applications: #D894172



Manufactured under one or more of the following U.S. Patents and pending applications: #D902196

95-7637

P D

NISSAN Altima 2019-UP*

- Designed specifically for Double-DIN installations
- Pioneer modular Double-DIN radio provision
- ISO Double-DIN radio with an “L” shaped chassis design, with the radio chassis at the bottom of the screen. Pioneer modular radios: DMH-C2550NEX / DMH-C2500NEX
- Painted gloss black with bright silver trim and a textured back plate to match the factory finish



99-7637

N P

NISSAN Altima 2019-UP*

- Molded in storage pocket for Single-DIN installations
- Painted gloss black with bright silver trim and a textured back plate to match the factory finish

Manufactured under one or more of the following U.S. Patents and pending applications: #D894175



95-7638

N P D

NISSAN Sentra 2020-UP*

- Designed specifically for ISO Double-DIN radios which have an “L” shaped chassis design, with the radio chassis at the bottom of the screen like the Alpine iLX-207
- Also designed for Pioneer® modular 6.8” radios like the DMH-C2550NEX and DMH-C2500NEX. *See radio manufacturer for current models
- Painted with a gloss black face, silver trim, and a custom textured housing



99-7638

T N P

NISSAN Sentra 2020-UP*

- ISO Single-DIN radio provision with a pocket
- Painted with a gloss black face, silver trim and a custom textured housing



95-7639HG

N P

NISSAN Titan 2020-UP*

- Designed for Double-DIN radio installations
- Painted gloss black to match the factory look and finish



99-7639HG

N P

NISSAN Titan 2020-UP*

- ISO Single-DIN radio provision with a pocket
- Painted gloss black to match the factory look and finish



88-00-7422

P D

- NISSAN TurboPocket Maxima 2007-2008 (without NAV) Sentra 2007-2012 (without pocket door)**
- Replacement pocket for factory display



98-7499

NISSAN Multi-Kit TurboPocket**

- The pocket is the same size as the vehicle factory pocket

SUZUKI

**99-2011**

SUZUKI | GM Multi-Kit** 1990-2012

- Combines Single-DIN and Double-DIN into one kit
- Double-DIN opening for newer aftermarket radios

**99-7950**SUZUKI **Grand Vitara** 2003-2005
XL7 2003-2006 | **Aerio** 2003-2004

- Metra's patented quick release snap-in ISO mounting system with ISO trim ring
- Recessed Single-DIN mount

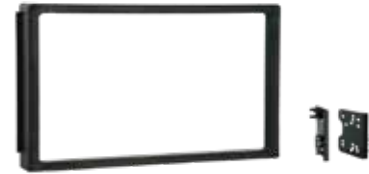
**95-7951**SUZUKI **Verona** | **Forenza** 2004-2008CHEVROLET **Aveo** 2004-2006**Aveo Hatchback** 2007-2008

- Designed for Double-DIN installations

**99-7951**SUZUKI **Verona** | **Forenza** 2004-2008CHEVROLET **Aveo** 2004-2006**Aveo Hatchback** 2007-2008

- Metra's patented quick release snap-in ISO mounting system with ISO trim ring
- Recessed Single-DIN mount

**99-7952**SUZUKI **Aerio** 2005-2007

- Metra's patented quick release snap-in ISO mounting system with ISO trim ring
- Recessed Single-DIN opening

**95-7953**SUZUKI **Grand Vitara** 2006-2012

- Designed for Double-DIN installations
- Painted matte black to match factory finish

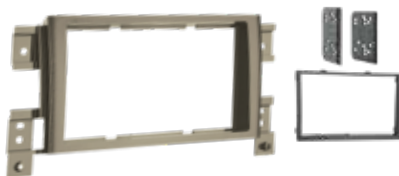

Manufactured under one or more of the following U.S. Patents and pending applications: #D503400

**95-7953T**SUZUKI **Grand Vitara** 2006-2012

- Designed for Double-DIN installations
- Painted tan to match factory finish

**99-7953**SUZUKI **Grand Vitara** 2006-2012

- Metra's patented quick release snap-in ISO mounting system with ISO trim ring
- Painted black to compliment factory finish

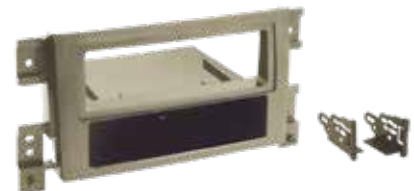
**95-7953T**SUZUKI **Grand Vitara** 2006-2012

- Metra's patented quick release snap-in ISO mounting system with ISO trim ring
- Painted to match factory tan finish

SUBARU



99-7954



SUZUKI **SX4 2007-2013**

- Metra's patented quick release snap-in ISO mounting system with ISO trim ring
- Parts included for Single-DIN and Double-DIN installations



95-7955



SUZUKI **Kizashi 2010-2013**

- Specifically designed for the mounting of aftermarket Double-DIN radios

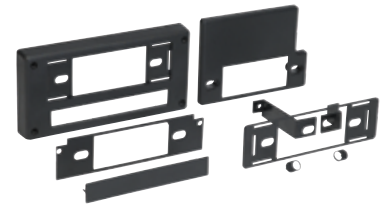

99-8900

SUBARU **Multi-Kit** 1981-1994**

- Multi-Purpose TurboKit offers quick conversion from 2-shaft to Single-DIN
- Fits entire Subaru line including the Justy and Legacy
- 1" extension to compensate for depth problems

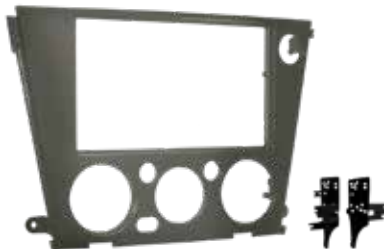

95-8901



SUBARU **Legacy | Outback 2.5i 2005-2009**

- (with manual climate controls)
- Double-DIN solution to compliment the existing 99-8901 for Single-DIN
 - Allows for the retention of the factory climate controls in their original location
 - Painted silver to match the factory color and finish
 - Use 70-8901 harness and 40-SB10 antenna adapter for a complete installation (sold separately)



99-8901



SUBARU **Legacy | Outback 2.5i 2005-2009**

- (with manual climate controls)
- Metra's patented quick release snap-in ISO mounting system with ISO trim ring
 - Allows for the retention of factory climate controls in their original location
 - Contoured, textured and painted gray to compliment factory dash



95-8902



SUBARU **Forester (without NAV) 2009-2013**

Forester (with DVD based NAV) 2009-2013

Impreza 2008-2011

Impreza WRX STI 2008-2012

Impreza WRX 2013-2014 (without NAV)

- Designed specifically for the installation of Double-DIN radios



99-8902

SUBARU **Forester (without NAV) 2009-2013**

Forester (with DVD based NAV) 2009-2013

Impreza 2008-2011 | Impreza WRX STI

2008-2012 | Impreza WRX 2013-2014

(without NAV)

- Metra's patented quick release snap-in ISO mounting system with ISO trim ring
- Recessed DIN opening



95-8903B



SUBARU **Legacy | Outback 2010-2014**

(without NAV)

- Double-DIN radio provision
- Painted a scratch-resistant matte black to match factory dash



95-8903S



SUBARU **Legacy | Outback 2010-2014**

(without NAV)

- Double-DIN radio provision
- Painted a scratch-resistant silver to match factory dash



SUBARU



99-8903B P

SUBARU **Legacy** | **Outback 2010-2014**
(without NAV)

- Single-DIN radio provision with pocket
- Painted a scratch-resistant matte black to match factory dash



95-8904B P D

SUBARU **Legacy** | **Outback 2010-2014**

- Double-DIN radio provision
- Sub-dash modifications required
- Painted a scratch-resistant matte black to match factory dash
- Radio mounts at an angle



95-8905B P D

SUBARU **Forester 2014-2015** (without NAV)
Impreza 2012-2014 (without NAV) | **WRX 2015**

- (without NAV) | **XV Crosstrek 2013-2014** (without NAV)
- Designed specifically for Double-DIN installations
 - Painted scratch-resistant matte black to match the factory color and finish



99-8905B P

SUBARU **Forester 2014-2015** (without NAV)
Impreza 2012-2014 (without NAV) | **WRX 2015** (without NAV) | **XV Crosstrek 2013-2014** (without NAV)

- Pocket included for Single-DIN installations
- Painted scratch-resistant matte black to match the factory color and finish



95-8906HG P D

SUBARU **Legacy** | **Outback 2015-2017**
SUBARU **Legacy** | **Outback 2018-2019** (2.5i base trim)

- Specific for Double-DIN installations
- Painted high gloss black

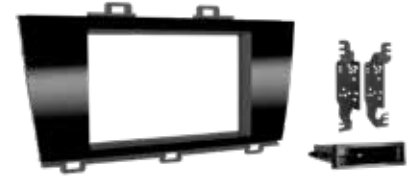

99-8906HG P

SUBARU **Legacy** | **Outback 2015-2017**
SUBARU **Legacy** | **Outback 2018-2019** (2.5i base trim)

- Pocket included for Single-DIN installations
- Painted high gloss black



95-8907HG P D

SUBARU **Multi-Kit** 2015-UP***

- Designed specifically for the installation of ISO Double-DIN radios
- Painted gloss black and silver to match the factory appearance
- Retains the factory climate controls in their original location



99-8907HG P

SUBARU **Multi-Kit** 2015-UP***

- Designed specifically for single ISO Single-DIN installations
- Painted gloss black and silver to match the factory appearance
- Retains the factory climate controls in their original location



95-8908HG P D

SUBARU **Crosstrek 2018-UP***
Impreza 2017-UP*

- Designed specifically for the installation of Double-DIN radios
- Painted high gloss black to match factory finish



99-8908HG



SUBARU **Crosstrek 2018-UP***
Impreza 2017-UP*

- Pocket included for the installation of Single-DIN radios
- Painted high gloss black to match factory finish

Manufactured under one or more of the following U.S. Patents and pending applications: #D830741



95-8909 / 99-8909



SUBARU **Legacy | Outback 2018-2019**

(excluding 2.5i trim)

- 95 - Designed specifically for the installation of Double-DIN radios
- 99 - Pocket included for the installation of Single-DIN radios
- Painted high gloss black to match factory finish

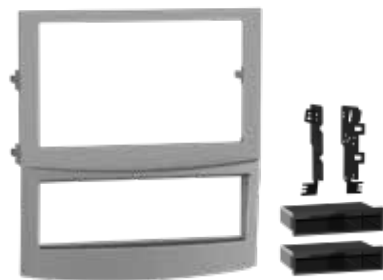

95-8910S / 99-8910S



SUBARU **Legacy | Outback 2010-2012** (with NAV)

- 95 - ISO Double-DIN radio provision
- 99 - ISO Single-DIN radio provision with pocket
- Includes a secondary pocket to replace the factory radio controls
- Painted silver to match the factory finish

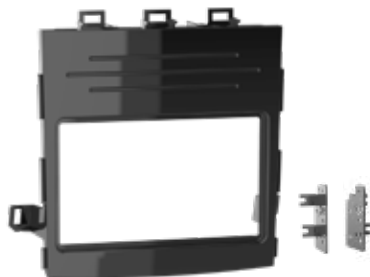

95-8911HG



SUBARU **Ascent 2019-UP***

- Designed specifically for the installation of Double-DIN radios
- Painted high gloss black to match factory finish

Manufactured under one or more of the following U.S. Patents and pending applications: #D896216

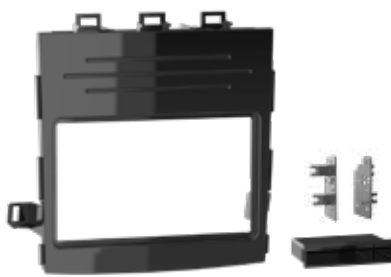

99-8911HG



SUBARU **Ascent 2019-UP***

- Pocket included for the installation of Single-DIN radios
- Painted high gloss black to match factory finish

Manufactured under one or more of the following U.S. Patents and pending applications: #D896158

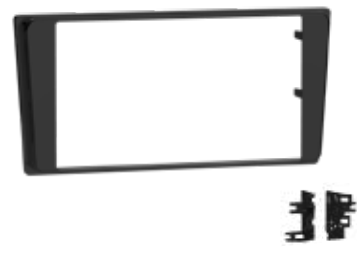

95-8912HG



SUBARU **BRZ 2016-UP***

- ISO Double-DIN radio provision
- Painted gloss black to match the factory appearance

Manufactured under one or more of the following U.S. Patents and pending applications: #D911325



99-8912HG



SUBARU **BRZ 2016-UP***

- ISO Single-DIN radio provision with pocket
- Painted gloss black to match the factory appearance

TOYOTA



88-00-8000

TOYOTA **Pocket 1981-2004**

- Using factory brackets, combine our pocket with an ISO Single-DIN mounted radio to replace a factory Double-DIN radio

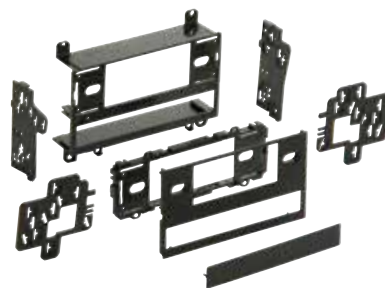

99-8100

TOYOTA **Multi-Kit** 1982-1995**

- Multi-purpose TurboKit offers quick conversion from 2-shaft to Single-DIN
- Unique push-through tabs with multiple side pieces make kit preparation easy

TOYOTA

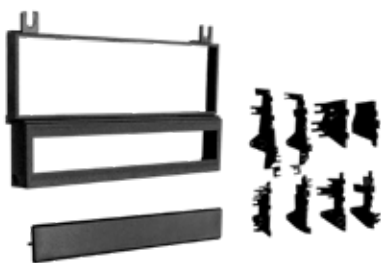

99-8101

TOYOTA Multi-Kit** 1984-2004

- Equalizer provision allows the installation of a 1/2 DIN equalizer

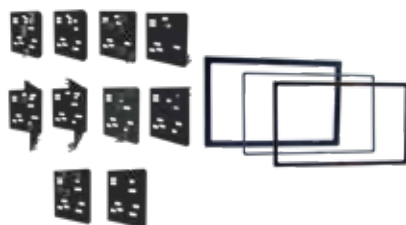

99-8104



Toyota Multi-Kit** 1989-2004

- Lots of mounting tabs on multiple brackets to cover tons of applications (covers the old 99-8101 and 99-8140 but does Single-DIN and Double-DIN)
- Great for when the factory brackets are missing
- Three different size trim rings are also included to adapt to a variety of radios and dash openings



99-8140

TOYOTA Pickup 1989-1995 | 4Runner 1989-2002 | T100 1993-1998 | Tacoma 1995-2004

- Equalizer provision allows the installation of a 1/2 DIN equalizer, or use the 87-00-9700 pocket in place of an EQ



99-8201

TOYOTA Celica | Echo 2000-2005

- Specially designed for ISO mount radios
- Pocket holds three CD jewel cases



95-8202



SCION | SUBARU | TOYOTA Multi-Kit** 2000-UP*

- Designed specifically for the installation of Double-DIN radios



99-8202

TOYOTA Mini Multi-Kit** 2000-2005

- Multi-use brackets can be modified to install a Single-DIN radio in any standard Toyota radio opening



95-8204



TOYOTA Corolla 2003-2008

- Designed specifically for the installation of Double-DIN radios



99-8204

TOYOTA Corolla 2003-2008

- Provides pocket with recessed mounting of a Single-DIN radio
- Uses ISO Single-DIN radio using Metra's patented ISO Quick-Release brackets



99-8205



TOYOTA Matrix 2003-2008

PONTIAC Vibe 2003-2008

- Fits an ISO mount unit with a pocket using Metra's snap-in ISO radio supports
- Designed for Single-DIN and Double-DIN installations





99-8206

TOYOTA **Highlander 2001-2007** (without NAV)
4Runner 2003-2009 (excluding limited trim)

- Provides pocket with recessed mounting of a Single-DIN radio or an ISO Single-DIN radio using Metra's patented ISO Quick-Release brackets
- For Highlander models with NAV, use 99-8260B



99-8207

TOYOTA **Sequoia 2003-2007**
Tundra 2003-2006

- Provides pocket with recessed mounting of a Single-DIN radio or an ISO Single-DIN radio using Metra's patented ISO Quick-Release brackets



95-8208



TOYOTA **Sienna 2004-2010**

- Designed specifically for the installation of Double-DIN radios



99-8208

TOYOTA **Sienna 2004-2010**

- Metra's patented quick release snap-in ISO mounting system with ISO trim ring
- Recessed Single-DIN mount



99-8209

SCION **xA | xB 2004-2016**
tC 2005-2010 | xD 2008-2016

- Recessed Single-DIN opening
- Metra's patented quick release snap-in ISO mounting system with ISO trim ring



95-8210



TOYOTA **4Runner 2003-2009** (limited without NAV)

- New and improved to better accommodate modern Double-DIN radios
- No more need for the factory brackets
- Specifically for the installation of Double-DIN radios



99-8210

TOYOTA **4Runner 2003-2009**
 (limited without NAV)

- Recessed DIN opening
- Metra's patented quick release snap-in ISO mounting system with ISO trim ring



95-8211



TOYOTA **Avalon 2000-2004**

- Designed specifically for the installation of Double-DIN radios



99-8211

TOYOTA **Avalon 2000-2004**

- Recessed Single-DIN opening
- Metra's patented quick release snap-in ISO mounting system with ISO trim ring

TOYOTA



95-8212



TOYOTA Camry Solara 2004-2008

- Designed specifically for the installation of Double-DIN radios
- Painted silver and contoured to match factory dashboard



99-8212

TOYOTA Camry Solara 2004-2008

- Recessed Single-DIN opening
- Metra's patented quick release snap-in ISO mounting system with ISO trim ring



99-8212S



TOYOTA Camry Solara 2004-2008

- Recessed Single-DIN opening
- Metra's patented quick release snap-in ISO mounting system with ISO trim ring
- Painted silver and contoured to match factory dashboard



99-8213

TOYOTA Prius 2004-2009

- ISO support system using the factory radio brackets

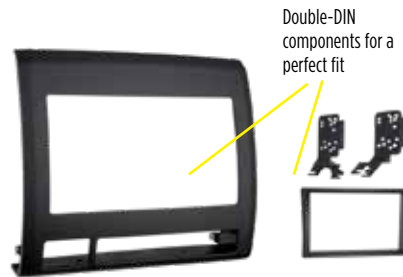

95-8214TB



TOYOTA Tacoma 2005-2011

- Double-DIN mounting bracket and trim for a perfect fit in a popular application
- Designed specifically for installation of Double-DIN radios
- Textured black



95-8214TG



TOYOTA Tacoma 2005-2011

- Double-DIN mounting bracket and trim for a perfect fit in a popular application
- Designed specifically for installation of Double-DIN radios
- Textured gray



99-8214TB



TOYOTA Tacoma 2005-2011

- Metra's patented quick release snap-in ISO mounting system with ISO trim ring
- Allows retention of factory climate controls in their original location
- Parts included for Single-DIN and Double-DIN installations
- Textured black



99-8214TG



TOYOTA Tacoma 2005-2011

- Metra's patented quick release snap-in ISO mounting system with ISO trim ring
- Allows retention of factory climate controls in their original location
- Parts included for Single-DIN and Double-DIN installations
- Textured gray



99-8215

TOYOTA Avalon 2005-2010

- Recessed Single-DIN opening



95-8215S



TOYOTA Avalon 2005-2010

- Specific for Double-DIN installations
- 99-8215 also available for Single-DIN installations
- Includes harness to retain the upper display which shows the climate information. Also pre-wired for the AXSWC (sold separately), and will retain the AUX input
- Painted to match the factory color and finish



99-8216

TOYOTA Yaris 2007-2011 | Yaris Sedan 2012

- Recessed Single-DIN opening
- Metra's patented quick release snap-in ISO mounting system with ISO trim ring
- Excludes S Models



95-8217B



Toyota RAV4 2006-2012

- Designed specifically for the installation of Double-DIN radios
- Painted to match the factory color and finish



99-8217



TOYOTA RAV4 2006-2012

- Metra's patented quick release snap-in ISO mounting system with ISO trim ring
- Painted silver and contoured to match factory dashboard
- Painted matte black and contoured to match factory dashboard



95-8218S



TOYOTA Camry 2007-2011

- Simple part for use with factory mounting brackets
- Specifically designed for Double-DIN radio installations
- Painted silver to match the factory color and finish



99-8218



TOYOTA Camry 2007-2011

- Metra's patented quick release snap-in ISO mounting system with ISO trim ring
- Parts included for Single-DIN and Double-DIN installations
- Painted silver and contoured to match factory dashboard



99-8219

TOYOTA FJ Cruiser 2007-2014

- Recessed Single-DIN opening
- Metra's patented quick release snap-in ISO mounting system with ISO trim ring



99-8220



**TOYOTA Tundra 2007-2013
Sequoia 2008-UP***

- Metra's patented quick release snap-in ISO mounting system with ISO trim ring
- Parts included for Single-DIN and Double-DIN installations
- Painted matte black



99-8220HG



**TOYOTA Tundra 2007-2013
Sequoia 2008-UP***

- Painted high gloss "piano black" to match factory finish
- Same features as 99-8220

TOYOTA

**99-8220CHG**

TOYOTA **Tundra 2007-2013**
Sequoia 2008-UP*

- Double-DIN and Single-DIN radio provision
- High gloss charcoal color to match factory finish

**99-8222**

TOYOTA **Highlander 2008-2012** (without NAV)

- Metra's patented quick release snap-in ISO mounting system with ISO trim ring
- Designed for Single-DIN and Double-DIN installations
- Painted matte black to match the factory finish

**99-8222BR**

TOYOTA **Highlander 2008-2012** (without NAV)

- Painted brown to match the factory finish
- Same features as the 99-8222

**95-8223**

TOYOTA **Corolla 2009-2013**

- Designed specifically for installation of Double-DIN radios
- Factory brackets are used for multiple applications and rigidity
- Painted matte black to match OEM color and finish

**99-8223**

TOYOTA **Corolla 2009-2013**

- Metra's patented quick release snap-in ISO mounting system with ISO trim ring
- Recessed Single-DIN opening
- Painted matte black to match OEM color and finish

**95-8223S**

TOYOTA **Corolla 2009-2013**

- Designed specifically for installation of Double-DIN radios
- Factory brackets are used for multiple applications and rigidity
- Painted silver to match OEM color and finish

**99-8223S**

TOYOTA **Corolla 2009-2013**

- Metra's patented quick release snap-in ISO mounting system with ISO trim ring
- Recessed Single-DIN opening
- Painted silver to match factory color and texture

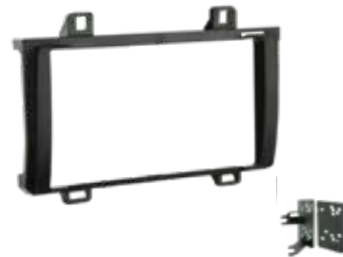
**95-8224**

TOYOTA **Matrix** | PONTIAC **Vibe 2009-2010**

- Designed specifically for installation of Double-DIN radios

**99-8224**

TOYOTA **Matrix** | PONTIAC **Vibe 2009-2010**

- Metra's patented quick release snap-in ISO mounting system with ISO trim ring
- Recessed Single-DIN opening.



95-8225G



TOYOTA Venza 2009-2015

- Designed specifically for installation of Double-DIN radios or two Single-DIN radios
- Painted to match factory color and texture
- Contoured and textured to compliment factory dash



99-8225G



TOYOTA Venza 2009-2015

- Designed for installation of Single-DIN radios
- Painted to match factory color and texture
- Contoured and textured to compliment factory dash



95-8226B



TOYOTA Prius 2010-2015

Prius Plug-In (PHV) 2012-2015

- Designed specifically for Double-DIN radio installations
- Painted a scratch-resistant matte black to match factory dash



99-8226B



TOYOTA Prius 2010-2015

Prius Plug-In (PHV) 2012-2015

- Designed with a pocket for Single-DIN radio installations
- Painted a scratch-resistant matte black to match factory dash



99-8227S



TOYOTA 4Runner 2010-UP*

- Double-DIN radio provision
- ISO Single-DIN radio provision with pocket
- Painted a silver finish
- Also available in high gloss charcoal; 99-8227CHG

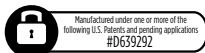

99-8228



TOYOTA Hilux 2005-2010

- Metra's patented quick release snap-in ISO mounting system with ISO trim ring
- Use 95-8202 for Double-DIN installations



99-8229S



TOYOTA SIENNA 2011-2014 (without NAV or with upper model NAV)

- Double-DIN and Single-DIN radio provision
- Painted silver to match factory finish



99-8230

SCION xA 2004-2006 | xB 2004-2015

tC 2005-2016 | xD 2008-2014

- Recessed Single-DIN opening with Metra's patented snap-in ISO mount system
- Use Metra's 95-8202 for Double-DIN installations



99-8231



TOYOTA Camry 2002-06

- Designed for installation of Single-DIN and Double-DIN aftermarket radios
- Double-DIN opening is revised for newer aftermarket radios
- Storage pocket included for Single-DIN installations

TOYOTA

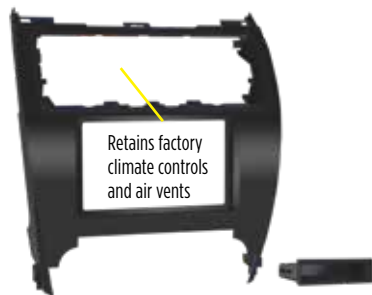
**99-8232B**TOYOTA **Camry 2012-2014**

- Pocket included for Single-DIN installations
- Provisions designed to retain factory climate controls and air vents



Manufactured under one or more of the following U.S. Patents and pending applications: #D702674

**99-8233B**TOYOTA **Avalon 2011-2012** (excluding OE NAV models)

- Designed for installation of Single-DIN and Double-DIN aftermarket radios
- Pocket included for Single-DIN installations
- Painted to match the factory color and finish

**99-8234**SCION **iQ 2012-2016**

- Single-DIN housing with an integrated storage pocket

**99-8235CHG**TOYOTA **Tacoma 2012-2015**

- Designed specifically for Double-DIN installations
- Painted high gloss charcoal to match the factory color and finish
- Also available in matte black as the 95-8235B



Manufactured under one or more of the following U.S. Patents and pending applications: #D755776

**99-8235CHG**TOYOTA **Tacoma 2012-2015**

- Pocket included for Single-DIN installations
- Painted high gloss charcoal to match the factory color and finish
- Also available in matte black as the 95-8235B

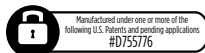

Manufactured under one or more of the following U.S. Patents and pending applications: #D755776

**99-8236**SCION **FRS 2012-2016**

- Single-DIN housing with an integrated storage pocket

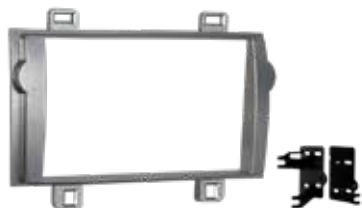
**95-8237S**TOYOTA **Matrix 2011-2012**

- Designed specifically for Double-DIN installations
- Painted silver to match the factory finish



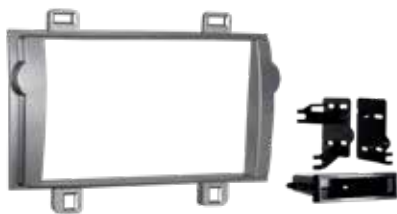

99-8237S



TOYOTA Matrix 2011-2012

- Pocket included for Single-DIN installations
- Painted silver to match the factory finish



99-8238



TOYOTA Yaris Hatchback 2012 | Yaris 2013-2017

- Single-DIN housing with an integrated storage pocket



95-8239B



TOYOTA Prius C 2012-2014

- Designed specifically for Double-DIN installations
- Painted scratch-resistant matte black



99-8239B



TOYOTA Prius C 2012-2014

- Pocket included for Single-DIN installations
- Painted scratch-resistant matte black



95-8240B



TOYOTA Prius 2004-2009

- Double-DIN installations
- Painted scratch-resistant matte black
- Use harness 70-1761 for standard (AXTO-TY1 for premium sound) and no antenna adapter is needed for a complete installation (sold separately)



99-8240B



TOYOTA Prius 2004-2009

- Pocket included for Single-DIN installations
- Painted scratch-resistant matte black
- Use harness 70-1761 for standard (AXTO-TY1 for premium sound) and no antenna adapter is needed for a complete installation (sold separately)



99-8241



TOYOTA Highlander 2013

- Single-DIN with Metra's patented quick release snap-in ISO mounting system with ISO trim ring
- Radio housing has a molded pocket and is textured for appearance
- Use harness 70-1761 for standard (AXTO-TY1 for premium sound) and 40-LX11 antenna adapter for a complete installation (sold separately)



95-8242G



TOYOTA RAV4 2013-2018

- Designed for Double-DIN installations
- Painted gray to match the factory color and finish
- Use harness 70-1761 for standard (AXTO-TY1 2013-2014.5 / AXTO-TY2 2014.5-UP*, for premium sound), and 40-LX11 antenna adapter for a complete installation (sold separately)



99-8242G



TOYOTA RAV4 2013-2018

- Pocket included for Single-DIN installations
- Painted gray to match the factory color and finish
- Use harness 70-1761 for standard (AXTO-TY1 2013-2014.5 / AXTO-TY2 2014.5-UP*, for premium sound), and 40-LX11 antenna adapter for a complete installation (sold separately)

TOYOTA

**95-8243B****TOYOTA Prius V 2012-2017**

- Designed for Double-DIN installations
- Painted scratch-resistant matte black
- Use harness 70-1761 for standard (AXTO-TY2 for premium sound) and 40-LX11 antenna adapter for a complete installation (sold separately)

**99-8243B****TOYOTA Prius V 2012-2017**

- Pocket included for Single-DIN installations
- Painted scratch-resistant matte black
- Use harness 70-1761 for standard (AXTO-TY2 for premium sound) and 40-LX11 antenna adapter for a complete installation (sold separately)

**95-8244HG****TOYOTA Avalon 2013-2018**

- (excluding OE NAV models)
- Designed for Double-DIN installations
- Painted a custom high gloss black
- Use harness 70-1761 for standard (AXTO-TY2 for premium sound) and 40-LX11 antenna adapter for a complete installation (sold separately)

**99-8244HG****TOYOTA Avalon 2013-2018**

- (excluding OE NAV models)
- Pocket included for Single-DIN installations
- Painted a custom high gloss black
- Use harness 70-1761 for standard (AXTO-TY2 for premium sound) and 40-LX11 antenna adapter for a complete installation (sold separately)

**95-8245CHG****TOYOTA Corolla 2014-2016**

- Designed for Double-DIN installations
- Painted a custom charcoal high gloss black
- Use harness 70-1761 and 40-LX11 antenna adapter for a complete installation (sold separately)

**99-8245CHG****TOYOTA Corolla 2014-2016**

- Pocket included for Single-DIN installations
- Painted a custom charcoal high gloss black
- Use harness 70-1761 and 40-LX11 antenna adapter for a complete installation (sold separately)

**95-8246HG****TOYOTA Tundra 2014-UP***

- Designed for Double-DIN installations
- Painted a custom high gloss black
- Use harness 70-1761 for standard (AXTO-TY2 for premium sound) and 40-LX11 antenna adapter for a complete installation (sold separately)

**99-8246HG****TOYOTA Tundra 2014-UP***

- Pocket included for Single-DIN installations
- Painted a custom high gloss black
- Use harness 70-1761 for standard (AXTO-TY2 for premium sound) and 40-LX11 antenna adapter for a complete installation (sold separately)

**95-8248B****TOYOTA Highlander 2014-2019**

- Specific for Double-DIN installations
- Painted to match the factory color and finish



99-8248B



TOYOTA Highlander 2014-2019

- Pocket included for Single-DIN installations
- Painted to match the factory color and finish



99-8249



TOYOTA Camry 2015-2017

- Parts included for Single-DIN or Double-DIN installations
- Built and painted in multiple colors to match the factory color and appearance



95-8250



TOYOTA Sienna 2015-UP*

- Designed specifically for Double-DIN installations
- Polished for gloss black factory match



99-8250



TOYOTA Sienna 2015-UP*

- Pocket is included for Single-DIN installations
- Polished for gloss black factory match



99-8251B



TOYOTA Tacoma 2016-UP*

- Painted scratch-resistant matte black
- Pocket included for Single-DIN installations
- Multiple trim plates included to cover all trim levels



99-8252



TOYOTA Tundra 2014-UP*

- New design with multiple textures and colors to match the factory color and appearance
- Parts included for installation of Single-DIN and Double-DIN radios



99-8259B



TOYOTA Prius C 2015-2017

- Specifically designed for Double-DIN installations
- Painted to match the factory color and finish
- Includes a pocket for Single-DIN installations
- Also available in gloss black as the 95 and 99-8259HG



99-8260B



TOYOTA Highlander 2001-2007 (with factory NAV)

- Designed for either Double-DIN radios or a pocket is included for Single-DIN radio installations
- Painted scratch-resistant matte black
- For models without NAV, use 99-8268



95-8262HG



TOYOTA Corolla 2017-2019 (excludes 2019 hatchback)

- Specifically designed for Double-DIN installations
- Painted high gloss black to match the factory finish

TOYOTA



95-8264HG P D

TOYOTA **Prius 2016-UP*** (excludes 11.6" touchscreen)
Prius Prime 2017-UP* (plus trim)

- Designed for the installation of Double-DIN radios
- Painted high gloss black to match factory finish.



99-8264HG P

TOYOTA **Prius 2016-UP*** (excludes 11.6" touchscreen)
Prius Prime 2017-UP* (plus trim)

- Pocket included for the installation of Single-DIN radios
- Painted high gloss black to match factory finish



95-8265HG P D

TOYOTA **C-HR 2018-UP***

- Designed for Double-DIN installations
- Painted high gloss black to match factory finish



99-8265HG P

TOYOTA **C-HR 2018-UP***

- Pocket included for the installation of Single-DIN radios
- Painted high gloss black to match factory finish



99-8266BLHG P D

TOYOTA **Camry 2018-UP*** (with 7" touchscreen radio)

- For the installation of both Single-DIN and Double-DIN radios
- Designed to match the factory finish
- Tinted metallic finish



99-8267 P D

TOYOTA **Matrix 2013**

- Parts included for the installation of both Single-DIN and Double-DIN radios



99-8268 D

TOYOTA **Highlander 2001-2007** (without NAV)
Sequoia 2001-2007 | Tundra 2001-2006

- Parts included for ISO Single-DIN and ISO Double-DIN installations
- A combo of the 99-8206*/99-8207, now with Single-DIN and Double-DIN in one package
- Excluding Toyota 4Runner



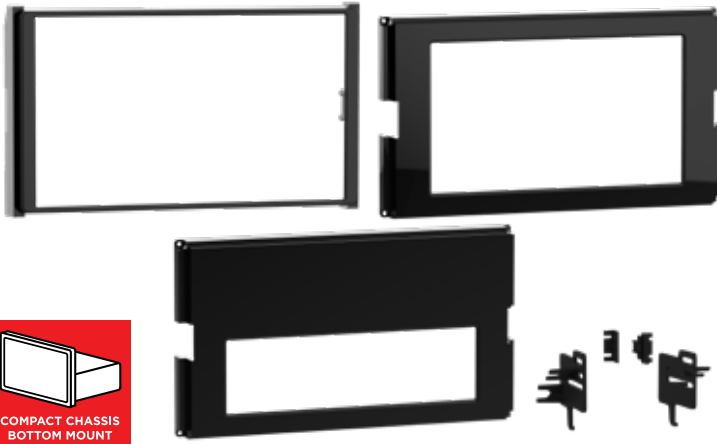

99-8270HG



TOYOTA **Corolla Hatchback 2019-UP*** | **Corolla 2020-UP***

- Designed for most Single-DIN radios and a special design for ISO Double-DIN radios with an “L” shaped chassis design with the radio chassis at the bottom of the screen. Specifically Alpine INE-W967HD, INE-W977HD, iLX-107, and iLX-207 (refer to radio manufacturer for current models)
- Special brackets included for Pioneer modular radios DMH-C2550NEX and DMH-C2500NEX (refer to radio manufacturer for current models)
- Painted high gloss black to match the factory finish



99-8300



TOYOTA **Multi-Kit** 2000-UP***

- Parts included for installation of both Single-DIN and Double-DIN radios
- Use harness 70-1761 for standard (AXTO-TY1 for premium sound) and 40-LX11 antenna adapter for a complete installation (sold separately)

LEXUS



95-8150



LEXUS ES Series 1992-1996

- Designed specifically for the installation of Double-DIN radios
- Painted matte black to match OEM color and finish



99-8150



LEXUS ES Series 1992-1996

- Provides pocket with recessed mounting of a Single-DIN radio or an ISO Single-DIN radio using Metra's patented ISO Quick-Release brackets
- Painted matte black to match OEM color and finish



99-8151



LEXUS IS Series 2001-2005

- Metra's patented quick release snap-in ISO mounting system with ISO trim ring
- Designed specifically for the installation of Single-DIN and Double-DIN radios
- Painted matte black to match OEM color and finish



95-8152



LEXUS GS Series 1998-2005

- (excluding OE NAV models)
- Designed specifically for the installation of Double-DIN radios
 - Painted matte black to match OEM color and finish



95-8153



LEXUS LS Series 1995-2000

- (excluding OE NAV models)
- Designed for the installation of Double-DIN radios
 - Painted matte black to match OEM color and finish



95-8154



LEXUS GS Series 1993-1997

- For the installation of Double-DIN radios
- Painted matte black to match OEM color and finish



99-8152



LEXUS GS Series 1998-2005

- (excluding OE NAV models)
- Recessed Single-DIN radio opening
 - ISO mount radio compatible using snap-in ISO radio mounts
 - Painted matte black to match OEM color and finish



99-8153



LEXUS LS Series 1995-2000

- (excluding OE NAV models)
- Metra's patented quick release snap-in ISO mounting system with ISO trim ring
 - Recessed Single-DIN mount
 - Painted matte black to match OEM color and finish



99-8154

LEXUS GS Series 1993-1997

- Metra's patented quick release snap-in ISO mounting system with ISO trim ring
- Oversized under-radio pocket
- Recessed Single-DIN mount
- Painted matte black to match OEM color and finish





95-8155



LEXUS ES Series 1997-2001

- Designed specifically for the installation of Double-DIN radios
- Painted matte black to match OEM color and finish



99-8155



LEXUS ES Series 1997-2001

- Recessed Single-DIN opening
- Metra's patented quick release snap-in ISO mounting system with ISO trim ring
- Painted matte black to match OEM color and finish



95-8156



LEXUS LS Series 1990-1994

- Designed for the installation of Double-DIN radios



99-8156

LEXUS LS Series 1990-1994

- Designed specifically for the installation of Single-DIN radios



95-8157B



LEXUS SC Series 1992-2000

- Designed specifically for installation of Double-DIN radios
- Painted matte black to match factory color and texture
- Contoured and textured to compliment factory dash



99-8157B



LEXUS SC Series 1992-2000

- Metra's patented quick release snap-in ISO mounting system with ISO trim ring
- Recessed Single-DIN opening
- Painted matte black to match factory color and texture



99-8158G



LEXUS ES 300 2002-2003

ES 330 2004-2006

- Designed for the installation of either Single-DIN or Double-DIN radios
- Oversized storage pocket included
- Painted gray to match the factory color and finish



99-8159S



LEXUS RX 330 | 350 | 400H 2004-2009

- Designed for installation of Single-DIN and Double-DIN aftermarket radios
- Painted silver to match the factory color and finish



95-8160G



LEXUS LS 430 2001-2006 (without factory NAV)

- Designed for Double-DIN installations
- Painted gray to match the factory color and finish
- Use AXTO-TY1 interface, 40-LX10 and 44-EC204 antenna adapter for a complete installation (sold separately)

LEXUS



99-8160G P

- LEXUS LS 430 2001-2006** (without factory NAV)
- Pocket included for Single-DIN installations
 - Painted gray to match the factory color and finish
 - Use AXTO-TY1 interface, 40-LX10 and 44-EC204 antenna adapter for a complete installation (sold separately)



99-8161S P D

- LEXUS SC 430 2002-2010**
- Designed for installation of Double-DIN or Single-DIN radios
 - Parts included for installation with or without the factory radio door
 - Painted silver to match the factory color and finish



99-8162G P D

- LEXUS ES Series 2007-2012** (without NAV)
- Designed for both Single-DIN or Double-DIN installations
 - Custom design retains the factory climate controls in their original location
 - Painted to match the factory color and appearance



99-8163 *Turbo Touch* P D

- LEXUS IS 250/350 2006-2013**
- Integrated 4.3" touchscreen and buttons retain and control most climate and vehicle customization functions
 - Patent pending touchscreen retains the factory safety features including backup camera
 - Retains steering wheel functionality - no need to purchase and install a separate steering wheel control interface!
 - 8 backlit buttons with over 250 customizable color options
 - For installation of Single-DIN and Double-DIN radios
 - Integrated passenger airbag and seat belt warning indicators



99-8164G *Turbo Touch* P D

- LEXUS RX 300 1999-2003**
- For both ISO Single-DIN and ISO Double-DIN
 - Touchscreen display for climate, audio interfacing and personalization features
 - Included interface for climate + steering wheel functions
 - Painted gray to match the factory finish



99-8164T *Turbo Touch* P D

- LEXUS RX 300 1999-2003**
- For both ISO Single-DIN and ISO Double-DIN
 - Touchscreen display for climate, audio interfacing and personalization features
 - Included interface for climate + steering wheel functions
 - Painted tan to match the factory finish



95-8166G P D

- LEXUS GX 470 2003-2009** (without NAV)
- ISO Double-DIN radio provision
 - Painted gray



86-9001

VOLKSWAGEN | AUDI | MERCEDES **Radio Removal Tool 1998-2006**



88-00-9008

VOLKSWAGEN **Pocket 2002-2006**

- Using our pocket with a Single-DIN radio will completely fill the Double-DIN opening left by the factory radio



99-9008

VOLKSWAGEN **New Beetle 1998-2010**

- Professional Installer Series Turbo Kit offers ISO Single-DIN and Single-DIN
- Unique side clips make installation fast



95-9009



VOLKSWAGEN **Touareg | Touareg 2 2004-2010**

- Designed specifically for the installation of Double-DIN radios
- Contoured to match factory dashboard
- High-grade ABS plastic



99-9009

VOLKSWAGEN **Touareg | Touareg 2 2004-2010**

- Recessed Single-DIN opening
- Metra's patented Snap-In ISO Support System



95-9011B



VOLKSWAGEN **Multi-Kit** 2005-UP***

- Revised from the existing 99-9011 but now specifically for Double-DIN
- Painted scratch-resistant matte black



99-9011



VOLKSWAGEN **Multi-Kit** 2005-UP***

- Recessed Single-DIN opening
- Metra's patented Snap-In ISO Support System
- Parts provided for Single-DIN and Double-DIN installations



95-9012



VOLKSWAGEN **Golf 1999-2006 GTI Jetta 1999-2005 (old style) Passat 2000-2005**

- Double-DIN radio provision



99-9013HG



VOLKSWAGEN **Golf Series 2015-UP***

- Designed for the installation of both ISO Single-DIN and ISO Double-DIN radios
- Designed with a heavy-duty sub-dash bracket for reinforced support
- Painted high gloss black

VOLKSWAGEN+PORSCHE



99-9014HG N P D

VOLKSWAGEN Jetta 2019-UP*

- ISO Single-DIN and Double-DIN radio provision
- Pioneer modular Double-DIN radio provision
- Painted high gloss black to match the factory finish
- Only for ISO Double-DIN radios which have an "L" shaped chassis design, with the radio chassis at the top of the screen - Pioneer modular radios: DMH-C2550NEX / DMH-C2500NEX.



95-9015HG N P D

VOLKSWAGEN Toureg 2011-2014

- ISO Double-DIN radio provision
- All in one panel which includes provisions for the factory hazard and button assembly
- All-inclusive kit, complete with wiring harness, MOST® amp interface, SWC interface, and antenna adapter
- Painted high gloss black



99-9604B P D

PORSCHE Cayenne 2003-2010

- Parts included for Single-DIN or Double-DIN installations
- Radio bracket design provides a solid mount without the need for a mounting sleeve
- Painted scratch-resistant matte black



99-9605B P D

PORSCHE 911 (996) 1999-2001 Boxster (986) 1997-2002

- Parts included for Single-DIN or Double-DIN installations
- Parts are included to relocate the factory climate controls to provide the space needed for aftermarket Double-DIN radios
- Painted scratch-resistant matte black



99-9606B P D

PORSCHE 911 (997) | Boxster | Cayman (981) 2005-2012

- Parts included for Single-DIN or Double-DIN installations
- Pocket included for Single-DIN installations
- Radio bracket design provides a solid mount without the need for a mounting sleeve
- Painted scratch-resistant matte black



99-9606G P D

PORSCHE 911 (997) | Boxster | Cayman (981) 2005-2012

- Parts included for Single-DIN or Double-DIN installs
- Pocket included for Single-DIN installations
- Radio bracket design provides a solid mount without the need for a mounting sleeve
- Painted gray to match the factory color and finish



95-9607B P D

PORSCHE 911 (991) 2012-2016 PORSCHE Boxster | Cayman (981) 2013-2016

- Designed specifically for the installation of Double-DIN radios
- Painted to match the factory finish



95-9608B P D

PORSCHE 911 (991) 2017-2019

- ISO Double-DIN radio provision
- All-inclusive kit, complete with wiring harness, SWC interface and antenna adapter
- Painted matte black



95-9609B



PORSCHE Cayenne (958) 2011-2016

- ISO Double-DIN radio provision
- All-inclusive kit, complete with wiring harness, SWC interface and antenna adapter
- Painted matte black



95-9610B



PORSCHE Cayenne (958) 2011-2016

- ISO Double-DIN radio provision
- All-inclusive kit, complete with wiring harness, MOST® amp interface, SWC interface, and antenna adapter
- Painted matte black



95-9611B



PORSCHE Cayenne (958) 2011-2016

- ISO Double-DIN radio provision
- All-inclusive kit, complete with wiring harness, SWC interface, and antenna adapter
- InfoAdapter kit, retains information on display
- Painted matte black



95-9612B



PORSCHE Cayenne (958) 2011-2016

- ISO Double-DIN radio provision
- All-inclusive kit, complete with wiring harness, MOST® amp interface, SWC interface, and antenna adapter
- InfoAdapter kit, retains information on display
- Painted matte black



95-9613B



PORSCHE Macan (95B) 2015-2018

- ISO Double-DIN radio provision
- All-inclusive kit, complete with wiring harness, SWC interface and antenna adapter
- Painted matte black



95-9614B



PORSCHE Macan (95B) 2015-2018

- ISO Double-DIN radio provision
- All-inclusive kit, complete with wiring harness, MOST® amp interface, SWC interface, and antenna adapter
- Painted matte black



95-9615B



PORSCHE Macan (95B) 2015-2018

- ISO Double-DIN radio provision
- All-inclusive kit, complete with wiring harness, SWC interface and antenna adapter
- InfoAdapter kit, retains information on display
- Painted matte black



95-9616B



PORSCHE Macan (95B) 2015-2018

- ISO Double-DIN radio provision
- All-inclusive kit, complete with wiring harness, MOST® amp interface, SWC interface, and antenna adapter
- InfoAdapter kit, retains information on display
- Painted matte black

AUDI



99-9100



AUDI Multi-Kit** | A4 | A6 | A8 1996-1999
TT 2000-2006

- Professional Installer Series TurboKit fits the factory radio opening perfectly



99-9103

AUDI A4 2000-2005 | A3 2006-2007

- TT 2002-2006 (Concert radio)
- Recessed Single-DIN mount
 - Painted matte black to match OEM color and finish



99-9105



- AUDI A4 2000-2001 (with Symphony radio)
- Interchangeable design allows recessed Single-DIN opening to be above or below the pocket
 - Parts included for Single-DIN or Double-DIN installations



99-9106



AUDI Multi-Kit** 1996-2007

- Single-DIN radio provision
- Covers multiple applications in one package



99-9107B



AUDI A4 | RS4 | S4 2002-2008

- (with Symphony or NAV radio)
- Parts included for Single-DIN or Double-DIN installations
 - Painted scratch-resistant matte black to match factory dash



99-9108B



AUDI A6 2000-2003

- Parts included for Single-DIN or Double-DIN installations
- Radio bracket design provides a solid mount without the need for a mounting sleeve
- Painted scratch-resistant matte black



99-9109B



AUDI A3 2006-2013

- New modern design allows for installation of Single-Din or Double-DIN radios
- Painted scratch-resistant matte black to match the factory finish
- No need for a metal mounting sleeve



95-9110B



AUDI A4 (8K) | A5 (8TF/8F7/8TA) 2009-2016

- (without MMI / excluding 09' convertible)
- ISO Double-DIN radio provision
 - All-inclusive kit, complete with wiring harness, SWC interface and antenna adapter
 - InfoAdapter kit, retains information on display
 - Painted matte black



95-9113B



AUDI A4 (8K) | A5 (8TF/8F7/8TA) 2009-2016

- (without MMI / excluding 09' convertible)
- ISO Double-DIN radio provision
 - All-inclusive kit, complete with wiring harness, MOST® amp interface, SWC interface and antenna adapter
 - InfoAdapter kit, retains information on display
 - Painted matte black



95-9114B



AUDI A4 (8K) | A5 (8TF/8F7/8TA) 2009-2016
(without MMI / excluding 09' convertible)

- ISO Double-DIN radio provision
- All-inclusive kit, complete with wiring harness, MOST® amp interface, SWC interface and antenna adapter
- InfoAdapter kit, retains information on display
- Painted matte black



VOLVO



99-9200

VOLVO 740 1984-1992 | 760 Series 1982-1990
780 Series 1986-1991 | 940 Series 1991-1995

- Unique side clips make installation fast



99-9222

VOLVO Multi-Kit** 1975-1994

- Recessed for Single-DIN
- Designed to mount precisely to the OEM radio mounting position



99-9227



VOLVO S60 2005-2009 | V70 2005-2007

- Parts included for installation of Single-DIN or Double-DIN radios
- New design for Double-DIN radios better follows the popular Metra design styles
- Use 70-9221 harness and 40-VL10 antenna adapter for a complete installation (sold separately)



99-9228B



VOLVO XC90 2003-2014

- Designed for installation of both ISO Single-DIN and ISO Double-DIN (2006-2014 only) radios
- Painted a custom scratch-resistant black



99-9229G



VOLVO S60 | V70 2001-2004

- ISO Single-DIN radio provision with pocket as well as an ISO Double-DIN radio provision
- Painted to match factory finish



99-9230G



VOLVO S80 | V70 1999-2006

- Designed for the installation of both Single-DIN and Double-DIN radios
- Painted gray to match the factory finish



99-9300

BMW 3 Series 1999-2006

M3 2001-2006 (without NAV)

- Professional Installer Series TurboKit fits DIN radios
- Matches factory dash contour perfectly



99-9301

BMW 5 Series 1997-2003 | X5 2000-2006

M5 2000-2003 (without NAV)

- Will accommodate a Single-DIN unit
- Contoured to match factory dashboard



99-9303

BMW Z4 2003-2008

- Will accommodate a Single-DIN unit
- Contoured to match factory dashboard



99-9305

BMW X3 2004-2010

- ISO mount only



95-9306B D

BMW 3 Series 2006-2013 (without NAV)

M3 2007-2013 (without NAV)

- Double-DIN radio provision
- Painted a scratch-resistant matte black to match factory dash

Manufactured under one or more of the following U.S. Patents and pending applications: #D639289



98-9306 D

BMW 3 Series 2006-2013 (without NAV)

M3 2007-2013 (without NAV)

- Used in installations when using the 95-9306B
- For retention of heated seat switches
- Extension cable included to relocate switches



99-9306B P

BMW 1 Series 2008-2013 | 3 Series 2006-2013

(without NAV) | M3 2007-2013 (without NAV)

- Painted a scratch-resistant matte black to match factory dash



95-9307B P D

BMW 5 Series 1997-2003 (without NAV)

M5 2000-2003

- Double-DIN radio provision
- Painted a scratch-resistant matte black to match factory dash

Manufactured under one or more of the following U.S. Patents and pending applications: #D639792



95-9308B P D

BMW X5 2000-2006 (without NAV)

- Double-DIN radio provision
- Painted a scratch-resistant matte black to match factory dash

Manufactured under one or more of the following U.S. Patents and pending applications: #D639793



95-9310B



BMW 3 Series 1999-2005

- Designed specifically for Double-DIN installations
- Included lower panel to relocate the factory climate controls
- Painted scratch-resistant matte black
- Built for vehicles with one long button window in the lower panel



95-9311B



BMW 3 Series 1999-2005

- Designed specifically for Double-DIN installations
- Included lower panel to relocate the factory climate controls
- Painted scratch-resistant matte black
- Built for vehicles with one long button window in the lower panel



95-9312B



BMW 3 Series 1999-2006

- Specifically designed for Double-DIN installations
- Parts are included to relocate the factory climate controls and modify the factory sub-dash, allowing the aftermarket radio to be installed flush
- Painted scratch-resistant matte black
- For cars with 5 separate buttons in the lower dash



95-9313B



BMW 3 Series 1999-2006

- Specifically designed for Double-DIN installations
- Parts are included to relocate the factory climate controls and modify the factory sub-dash, allowing the aftermarket radio to be installed flush
- Painted scratch-resistant matte black
- For cars with one large button panel



95-9314B



BMW 5 Series 2004-2007

- Designed specifically for Double-DIN installations
- Included lower panel to relocate factory climate controls
- Painted scratch-resistant matte black
- Built for vehicles with one long button window in the lower panel



95-9327B



BMW 1 Series 2008-2013

- ISO Double-DIN radio provision
- Painted scratch-resistant matte black



MINI



99-9302

MINI Cooper 2002-2006 (All) Convertible 2007-2008

- Designed to fit the factory radio opening perfectly
- Will accommodate a Single-DIN unit



99-9309



MINI COOPER Clubman (R55) 2008-2014* Convertible (R57) 2009-2015* Coupe (R58) | Roadster (R59) 2012-2015* Hatchback (R56) 2007-2013* (without NAV option)

- Included blank out plates are designed to fill in voids
- Single and Double-DIN radio with pocket provision
- ISO stacked radio provision
- Painted and textured to match factory finish



99-9326B



MINI Cooper Hardtop Coupe (F56) 2014-2017* Cooper Sedan (F55) 2015-2017* (with base radio)

- Parts included for both ISO Single-DIN and ISO Double-DIN installations
- Painted scratch-resistant matte black to match the factory finish
- Retains the factory hazard button

* Base model radios without high-def display only

MERCEDES-BENZ



99-6512 D

MERCEDES-BENZ **Metris 2016-UP***
 MERCEDES-BENZ **Sprinter 2010-2018**
 DODGE **Sprinter 2007-2009**
 FREIGHTLINER **Sprinter 2007-2018**

- Metra's patented quick release snap-in ISO mounting system with ISO trim ring
- Recessed Single-DIN opening
- Includes parts for installation of Double-DIN radios



99-8710

MERCEDES-BENZ **C-Class 2001-2004**
CLK-Class 2004 | **CLK-500** | **CLK55 AMG 2003** | **G-Class 2002-2006**

- Provides pocket with mounting of a Single-DIN radio



99-8713 D

MERCEDES-BENZ **SLK 2005-2011**

- Recessed Single-DIN mount
- Designed for the installation of Single-DIN and Double-DIN radios



99-8715 D

SMART **Fortwo 2008-2010**

- Built-in storage pocket
- Recessed DIN mount
- Designed for DIN and Double-DIN radios



99-8716B P

MERCEDES-BENZ **GLK 2010-2012**

- ISO Single-DIN radio provision
- Metra's patented quick release snap-in ISO mounting system with ISO trim ring
- Painted matte black to match the factory finish



95-8721B P D

MERCEDES-BENZ **C-Class 2005-2007**

- Double-DIN installations
- Painted scratch-resistant matte black



99-8721B P

MERCEDES-BENZ **C-Class 2005-2007**

- Pocket included for Single-DIN installations
- Painted scratch-resistant matte black



95-8722B P D

MERCEDES-BENZ **C-Class 2001-2004**

- Designed for Double-DIN installations
- Painted scratch-resistant matte black



99-8722B P

MERCEDES-BENZ **C-Class 2001-2004**

- Pocket included for Single-DIN installations
- Painted scratch-resistant matte black



99-8723B



MERCEDES-BENZ **ML** 2006-2011

- Designed for the installation of both Single-DIN and Double-DIN radios
- Painted scratch-resistant matte black



99-8724B



MERCEDES-BENZ **CLK** 2005-2009

- Designed for the installation of both Single-DIN and Double-DIN radios
- Painted scratch-resistant matte black



99-8725B



MERCEDES-BENZ **C-Class** 2012-2015

- For the installation of both Single-DIN and Double-DIN radios
- Painted scratch-resistant matte black



95-8727B



MERCEDES-BENZ **CL-Class** 2003-2006

- For the installation of Double-DIN radios
- Painted black to match the factory finish



95-8727W



MERCEDES-BENZ **CL-Class** 2003-2006

- For the installation of Double-DIN radios
- Painted wood grain to match the factory finish



95-8731



MERCEDES-BENZ **Sprinter** 2019-UP*

- (excluding models equipped with a touchscreen radio)
- Designed for Double-DIN installations
 - Polished gloss black to match the factory finish



99-8731

MERCEDES-BENZ **Sprinter** 2019-UP*

- (excluding models equipped with a touchscreen radio)
- ISO Single-DIN radio provision with pocket
 - Polished gloss black to match the factory finish



95-8732B



MERCEDES-BENZ **E-CLASS** 2003-2009

- Designed specifically for ISO Double-DIN installations
- Painted scratch-resistant matte black to match the factory appearance



95-8733B



MERCEDES-BENZ **C CLASS** 2008-2011

- ISO Double-DIN radio provision
- Upper panel with a recessed re-location of factory buttons included
- Painted scratch-resistant matte black



MERCEDES-BENZ+SMART



95-8734B P D

MERCEDES-BENZ **S CLASS 2000-2006**

- ISO Double-DIN radio provision
- Painted scratch-resistant matte black



95-8734W T D

MERCEDES-BENZ **S CLASS 2000-2006**

- ISO Double-DIN radio provision
- Coated with hydrographic film for a woodgrain finish



95-8735B P D

MERCEDES-BENZ **SL CLASS 2003-2008**

- ISO Double-DIN radio provision
- Painted scratch-resistant matte black

SMART



95-8720B P D

SMART **Fortwo 2011-2015**

- Double-DIN installations
- Painted scratch-resistant matte black
- Use 70-1783 harness and 40-VW10 antenna adapter for a complete installation (sold separately)



99-8720B P

SMART **Fortwo 2011-2015**

- Pocket included for Single-DIN installations
- Painted scratch-resistant matte black
- Use 70-1783 harness and 40-VW10 antenna adapter for a complete installation (sold separately)

LAND ROVER



89-9400

LAND ROVER **Discovery 1994-2004**

- DIN-mountable trim plate for this premium vehicle application



99-9401 D

LAND ROVER **Freelander 2004-2005**

- Interchangeable design allows recessed Single-DIN opening to be above or below the pocket



99-9402B P D

LAND ROVER **Range Rover 2003-2012**

- Parts included for the installation of both Single-DIN and Double-DIN radios
- Painted scratch-resistant matte black



95-9403B



LAND ROVER **Evoque 2013-2019**

- Designed specifically for the installation of Double-DIN radios
- Painted to match the factory finish



95-9405B



LAND ROVER **LR2 2008-2012 | LR3 2005-2009 | Range Rover Sport 2006-2009**

- For the installation of Double-DIN radios
- Painted to match the factory finish



JAGUAR



95-9406B



LAND ROVER **LR2 2008-2012 | LR3 2005-2009 | Range Rover Sport 2006-2009**

- For the installation of Double-DIN radios
- Painted to match the factory finish



99-9501B



JAGUAR **S-Type 2003-2008 X-Type 2002-2008**

- For both Single-DIN and Double-DIN installations
- Painted matte black to match dash



99-9501G



JAGUAR **S-Type 2003-2008 X-Type 2002-2008**

- For both Single-DIN and Double-DIN installations
- Painted gray to match factory dash

UNIVERSAL

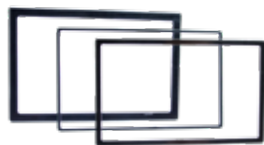

89-50-0900



TRIM RINGS **Universal**

- Universal for Double-DIN radio installations
- Includes one of three different sizes: .125, .250 and .375"
- Trim rings all have interior opening of 3.95" x 6.825"



88-00-9000

FORD | MAZDA | NISSAN | TOYOTA | VOLVO

Under Radio Multi-Pocket

- Use with factory brackets for ISO Single-DIN installs or when the factory radio and pocket are not present
- Snap-on trim rings blend the pocket to the dash
- Comes with three different trim bezels to accommodate most installs



95-9000



UNIVERSAL **Double-DIN Housing**

- For the install of Double-DIN radios
- Textured to match factory dash

UNIVERSAL



99-9000

UNIVERSAL Single-DIN Housing

- Fully encloses the unit
- Dimensions: 3.5"H x 10"W x 9"D



99-9003B

UNIVERSAL Black Marine Cover System

- Magnetic latch - No pushbuttons to break or stick
- Magnetic seal held in place with 3M adhesive
- Retention hinged so the door will stay open
- No other Marine cover uses this style of hinge
- Design accommodates most Single-DIN head units
- High-Temp and UV resistant polycarbonate construction
- Stainless steel mounting hardware included



99-9003W

P

UNIVERSAL White Marine Cover System

- Magnetic latch - No pushbuttons to break or stick
- Magnetic seal held in place with 3M adhesive
- Retention hinged so the door will stay open
- No other Marine cover uses this style of hinge
- Design accommodates most Single-DIN head units
- High-Temp and UV resistant polycarbonate construction
- Stainless steel mounting hardware included



99-9005B

UNIVERSAL Marine Cover System

- Positive spring-loaded detent lock
- Longer life, heavy-duty, low-friction hinges
- Dual spring support while cover is open
- Accu-view tinted cover
- Black or white finish (Order 99-9005 for white)



99-9006

UNIVERSAL Marine Radio Housing

- White molded UV-resistant polycarbonate
- Smoke tinted door - spring-loaded with retention hinge
- Pre-wired for easy installation
- Stainless steel mounting hardware included
- Housing only - radio not included

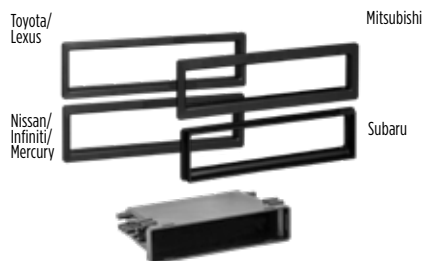

88-00-9006

TOYOTA | NISSAN | SUBARU UP TO 2008 MITSUBISHI Multi-Kit** 1982-2004

- Four trim plates and one pocket for multiple applications



88-00-9007

TOYOTA | NISSAN | SUBARU UP TO 2008 MITSUBISHI Multi-Kit** 1982-2004

- USB charging adapter included
- Four trim plates and one pocket



95-9999

UNIVERSAL ISO Trim

- ISO brackets molded to front plate
- Cut to fit front plate

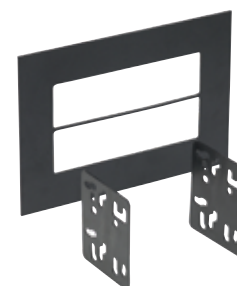

99-9999

D

UNIVERSAL ISO Trim

- To finish off a Double-DIN radio installation
- Can also finish off two ISO stacked radios
- ISO stacked radios are held together with our ISO brackets and/or the factory brackets
- Dimensions: 9 3/4" x 6 3/4" x 1/8"

Metra Electronics is the only aftermarket dash kit manufacturer designing installation kits specific to the non-traditional DIN and Double-DIN radios that have been hitting the market. "There are many obstacles to overcome when designing installation kits for radios going into vehicles that have limited space. The new radio designs with less bulk provide Metra's engineers with more freedom in creating a product to install a sleek looking screen into a dashboard that doesn't have space for the larger footprint of the typical ISO Double-DIN radio that we've been designing for over the past 20 years. The new style radios are a major improvement to our industry and Metra is proud to be at the forefront of this trend with solutions to make installation seamless,"



107 SERIES:

The 107 Series is designed specifically for ISO Double-DIN radios which have an "L" shaped chassis design, with the radio chassis at the bottom of the screen like the Alpine iLX-207 or the chassis at the top of the screen like the Sony XAV-AX5000. In some cases, the kit can also be used for what we call shallow chassis mountable radios. These may be full height of traditional Double-DIN, but about half the depth, allowing for kits to be designed for cars without that depth. They are also designed for Pioneer modular 6.8" radios like the DMH-C2550NEX and DMHC2500NEX. A modular radio is a screen with a separate radio chassis that can be mounted up to 6 feet away (with the Pioneer products)

108 AND 109 SERIES FOR PIONEER 8" AND 9" MODULAR RADIOS:

The 108 Series is designed specifically for Pioneer's 8" modular solutions receiver (DMHC5500NEX).

THREE MULTI-APPLICATION "FLOATING" KITS FOR PIONEER MODULAR RADIOS:

Using a Double-DIN Metra kit mounted to the vehicle and then the 109-UN02, 108-UN02, or 107-UN02 mounts the Pioneer radio chassis into the dashboard and allows the Pioneer screen to float out in front of the factory radio opening. Instead of creating a whole new line of 1,000+ dash kits specifically for these radios, the universal kit allows an installer to take kits they already have and make them work for this, without custom fabrication.

JEEP



108-CH1B P

JEEP Wrangler JK (only) 2011-2018

Designed specifically for the Pioneer DMH-C5500NEX 8" radio

- Cutting template included for necessary dash modifications
- Painted scratch-resistant matte black



107-CH3B P

JEEP Wrangler JL | Gladiator 2018-UP*

Designed for most shallow mount radios like the Alpine iLX-W650

- Special brackets included for Pioneer modular radios DMH-C2550NEX and DMHC2500NEX
- Painted scratch-resistant matte black to match the factory finish
- Refer to radio manufacturer for current models

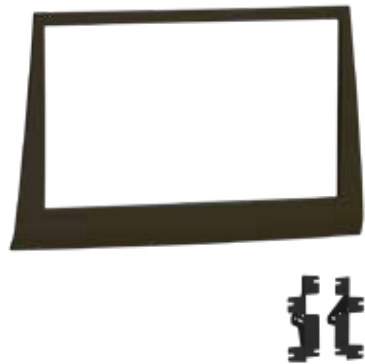
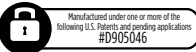

108-CH4DK P

JEEP Commander 2006-2007

Designed specifically for the Pioneer DMH-C5500NEX 8" radio

- Painted dark khaki to match the factory dash panel



RADIO SPECIFIC



108-CH4G

P

JEEP Commander 2006-2007

Designed specifically for the Pioneer DMH-C5500NEX 8" radio

- Painted gray to match the factory finish



107-CH5

T

P

D

JEEP Grand Cherokee 1996-1998

- This kit is designed for an ISO Double-DIN radio which have an "L" shaped chassis design, with the radio chassis at the top of the screen, or Pioneer modular 6.8" radios
- Textured to match the factory finish
- Parts included to retain use of the factory vents



DODGE



108-CH2B



P

DODGE RAM 1500/2500/3500 2013-2017 (with 5" or 8" touchscreen)

Designed specifically for the Pioneer DMH-C5500NEX 8" radio

- Touchscreen display for climate, audio interfacing and personalization features
- Included interface for climate and steering wheel functions
- Painted scratch-resistant matte black to match the factory finish

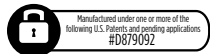

FORD



107-FD1B

P

D

FORD Transit 2020-UP*

- This kit is designed for an ISO Double-DIN radio with an "L" shaped chassis design, with the radio chassis at the bottom of the screen, or Pioneer modular 6.8" radios.
- * Refer to the radio manufacturer for current models

- Painted scratch-resistant matte black



108-FD1CH



P

FORD F-150 2015-2017 | F-250/350/450/550 2017-2018 (base model "XL" with CD "XLT")

Designed specifically for the Pioneer DMH-C5500NEX 8" radio

- Touchscreen display for climate, audio interfacing and personalization features
- Included interface for climate and steering wheel functions
- Integrated passenger airbag indicator
- Painted charcoal to match the factory finish



RADIO SPECIFIC



108-FD2B



FORD **F-150 2013-2014** (with 4.3" screen)

Designed specifically for the Pioneer DMH-C5500NEX 8" radio

- Touchscreen display for climate, audio interfacing and personalization features
- Included interface for climate and steering wheel functions
- Integrated passenger airbag indicator and hazard button
- Painted scratch-resistant matte black



108-FD3B



FORD **F-150 2013-2014** (with CD player, without color screen)

F-150 XL 2009-2013 (with CD player) | **F-150 XLT 2009-2012** (without NAV)

Designed specifically for the Pioneer DMH-C5500NEX 8" radio

- Painted scratch-resistant matte black



108-FD4CH



FORD **Mustang 2010-2014**

Designed specifically for the Pioneer DMH-C5500NEX 8" radio

- Touchscreen display for climate, audio interfacing and personalization features
- Included interface for climate and steering wheel functions
- Painted charcoal to match the factory finish



108-FD5CH



FORD **Mustang 2015-UP*** (with 4.2" screen)

Designed specifically for the Pioneer DMH-C5500NEX 8" radio

- Touchscreen display for climate, audio interfacing and personalization features
- Included interface for climate and steering wheel functions
- Painted charcoal to match the factory finish



108-FD6CH



FORD **Mustang 2015-UP*** (with 8" screen)

Designed specifically for the Pioneer DMH-C5500NEX 8" radio

- Touchscreen display for climate, audio interfacing and personalization features
- Included interface for climate and steering wheel functions
- Painted charcoal to match the factory finish



108-FD7B



FORD **Super Duty F-250/350/450/550 XL 2017-UP***
(without color screen)

Designed specifically for the Pioneer DMH-C5500NEX 8" radio

- Painted scratch-resistant matte black



RADIO SPECIFIC



108-FD8CH



P

FORD Explorer **2011-2015** (with factory 8" touchscreen)

Designed specifically for the Pioneer DMH-C5500NEX 8" radio

- Touchscreen display for climate and most personalization features
- Included interface for climate and steering wheel functions
- Integrated hazard switch and passenger airbag indicator
- Painted charcoal to match the factory finish



108-FD9B

P

FORD Ranger **2019-UP*** (with 4.2" screen)

Designed specifically for the Pioneer DMH-C5500NEX 8" radio

- Includes parts that allow the retentions of the factory climate control panel, passenger airbag indicator and hazard button
- Painted scratch-resistant matte black to match the factory appearance



GM

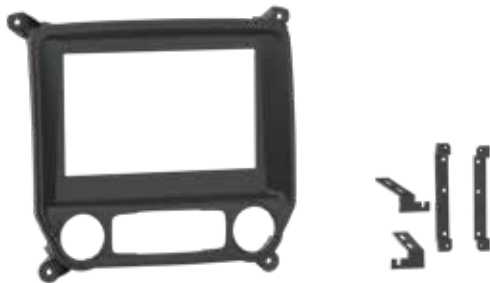

108-GM1G

P

CHEVROLET Silverado 1500 | GMC Sierra 1500 **2014-2018**
 CHEVROLET Silverado 2500/3500 | GMC Sierra 2500/3500 **2015-2018**
 CHEVROLET Silverado 1500 LD | GMC Sierra 1500 Limited **2019**

Designed specifically for the Pioneer DMH-C5500NEX 8" radio

- Painted gunmetal gray



108-GM2B

P

CHEVROLET Tahoe | Avalanche | GMC Yukon **2007-2014**

CHEVROLET Silverado | GMC Sierra **2007-2014**

(with center console, excludes Classic trim models)

Designed specifically for the Pioneer DMH-C5500NEX 8" radio

- Replacement dash panel allows for minimal dash modifications
- Painted scratch-resistant matte black



107-GM3B

P

CHEVROLET Camaro **2016-UP***

Designed specifically for the Pioneer DMH-C5500NEX & DMH-C2500NEX modular radios

- Painted scratch-resistant matte black to match the factory finish
- Refer to radio manufacturer for current models



108-GM3B

P

CHEVROLET Camaro **2016-UP***

Designed specifically for the Pioneer DMH-C5500NEX 8" radio

- Painted scratch-resistant matte black to match the factory finish





107-GM4B



CHEVROLET **Silverado** | GMC **Sierra 2019-UP***

Designed specifically for the Pioneer modular radios DMH-C2550NEX and DMHC2500NEX

- Blank out plate included to replace the factory radio control buttons
- Painted scratch-resistant matte black to match the factory finish
- Refer to radio manufacturer for current models



107-GM5B *Turbo*



CADILLAC **SRX 2010-2012**

- Integrated OLED screen to retain display of climate control information
- Trim panel retains use of the factory climate control buttons
- Designed for most shallow mount radios like the Alpine iLX-W650
- Refer to radio manufacturer for current models
- Special brackets included for Pioneer modular radios DMH-C2550NEX and DMHC2500NEX



107-K11



KIA **Seltos 2020-2021**

- Designed specifically for ISO Double-DIN radios which have an "L" shaped chassis design, with the radio chassis at the bottom of the screen like the Alpine iLX-207. Also designed for 6.8" Pioneer® Modular Solutions radios like the DMH-C2550NEX and DMH-C2500NEX
- See radio manufacturer for current models
- Textured to match the factory finish



108-K11



KIA **Seltos 2020-2021**

- Engineered exclusively for the 8" Pioneer® Modular Solutions DMH-C5500NEX
- See radio manufacturer for current models
- Textured to match the factory finish



109-K11



KIA **Seltos 2020-2021**

- Engineered exclusively for 9" Pioneer® Modular Solutions DMH-WC6600NEX
- See radio manufacturer for current models
- Textured to match the factory finish



RADIO SPECIFIC

MINI + MAZDA



107-MI1 *Turbo* P

- MINI Countryman | Paceman 2011-2016** (without factory NAV)
- Designed specifically for 6.8" Pioneer® Modular Solutions DMH-C250NEX and DMH-C2500NEX
 - See radio manufacturer for current models
 - Includes a block out panel for factory radio buttons no longer used
 - High polished processing provides a look that's similar to both the aftermarket radio and factory finish



108-MI1 *Turbo* P

- MINI Countryman | Paceman 2011-2016** (without factory NAV)
- Designed specifically for the 8" Pioneer® Modular Solutions DMH-C5500NEX
 - See radio manufacturer for current models
 - Includes a block out panel for factory radio buttons no longer used
 - High polished processing provides a look that's similar to both the aftermarket radio and factory finish



107-MZ1B P D

- MAZDA CX-3 2016-2020 | TOYOTA Yaris 2019-2020**
- Designed specifically for ISO Double-DIN radios which have an "L" shaped chassis design, with the radio chassis at the bottom of the screen like the Alpine iLX-207
 - Also designed for Pioneer modular 6.8" radios like the DMH-C2550NEX and DMH-C2500NEX. *See radio manufacturer for current models
 - Painted scratch-resistant matte black



TOYOTA



107-TO1HG P D

- TOYOTA RAV4 2019-UP***
- Designed specifically for ISO Double-DIN radios which have an "L" shaped chassis design, with the radio chassis at the bottom of the screen like the Alpine iLX-207
 - Also designed for Pioneer modular 6.8" radios like the DMH-C2550NEX and DMH-C2500NEX. *See radio manufacturer for current models
 - Painted high gloss black to match the factory appearance



108-TO1B P

- TOYOTA Tundra 2007-2013 | Sequoia 2008-UP***
- Designed specifically for the Pioneer DMH-C5500NEX 8" radio**
- Painted scratch-resistant matte black





108-TO1HG

P

TOYOTA **Tundra 2007-2013** | **Sequoia 2008-UP***
 Designed specifically for the Pioneer DMH-C5500NEX 8" radio
 • Painted high gloss black



108-TO1CHG Turbo 2.0T

P

TOYOTA **Tundra 2007-2013** | **Sequoia 2008-UP***
 Designed specifically for the Pioneer DMH-C5500NEX 8" radio
 • Painted high gloss charcoal (matches 2010-UP*)



108-TO2B

P

TOYOTA **Tacoma 2012-2015**
 Designed specifically for the Pioneer DMH-C5500NEX 8" radio
 • Painted scratch-resistant matte black



108-TO2CHG

P

TOYOTA **Tacoma 2012-2015**
 Designed specifically for the Pioneer DMH-C5500NEX 8" radio
 • Painted high gloss charcoal



108-TO3B

P

TOYOTA **Highlander 2008-2012**
 Designed specifically for the Pioneer DMH-C5500NEX 8" radio
 • Painted scratch-resistant matte black



108-TO3BR

P

TOYOTA **Highlander 2008-2012**
 Designed specifically for the Pioneer DMH-C5500NEX 8" radio
 • Painted brown to match the factory finish



RADIO SPECIFIC



108-TO4

P

TOYOTA **Camry 2015-2017**

Designed specifically for the Pioneer DMH-C5500NEX 8" radio

- Built-in multiple pieces and painted two-tone to match the factory appearance

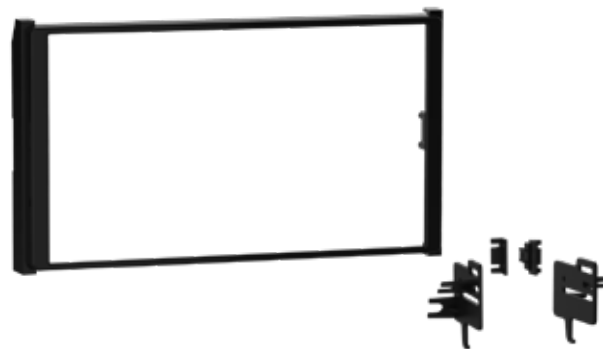

108-TO5HG

P

TOYOTA **Corolla Hatchback 2019-UP*** | **Corolla 2020-UP***

Designed specifically for the Pioneer DMH-C5500NEX 8" radio

- Painted high gloss black to match the factory finish

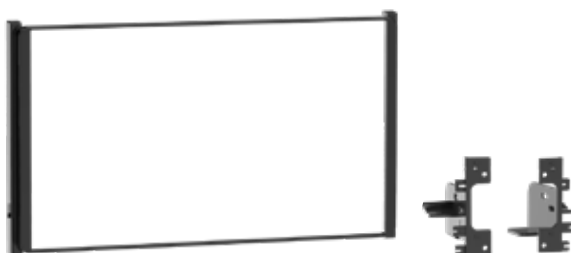

108-TO6HG

P

TOYOTA **RAV4 2019-UP***

Designed specifically for the Pioneer DMH-C5500NEX 8" radio

- See radio manufacturer for current models
- Painted high gloss black to match the factory appearance



107-TO7HG

P

TOYOTA **Highlander 2020** (without factory 12.3" screen)

- Designed specifically for ISO Double-DIN radios which have an "L" shaped chassis design, with the radio chassis at the bottom of the screen like the Alpine iLX-207
- Also designed for Pioneer modular 6.8" radios like the DMH-C2550NEX and DMH-C2500NEX
- Painted high gloss black to match the factory appearance



108-TO7HG

P

TOYOTA **Highlander 2020** (without factory 12.3" screen)

Designed specifically for the 8" Pioneer® Modular Solutions DMH-C5500NEX

- See radio manufacturer for current models
- Painted high gloss black to match the factory appearance



109-TO7

P

TOYOTA **Highlander 2020** (without factory 12.3" screen)

Designed specifically for the 9" Pioneer® Modular Solutions Receiver (DMH-WC6600NEX) Radio

- See radio manufacturer for current models



UNIVERSAL TRIM

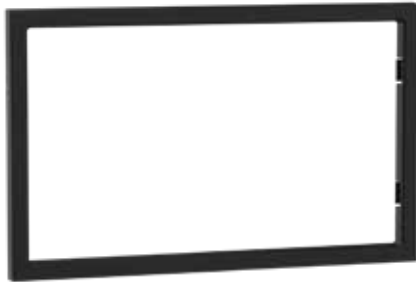

108-UN01

UNIVERSAL Trim

Designed specifically for the Pioneer DMH-C5500NEX 8" radio

- 3/8" border trim that snaps onto the Pioneer's separate screen
- Designed for the finishing touch to a custom-built install

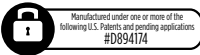

UNIVERSAL FLOATING MOUNT

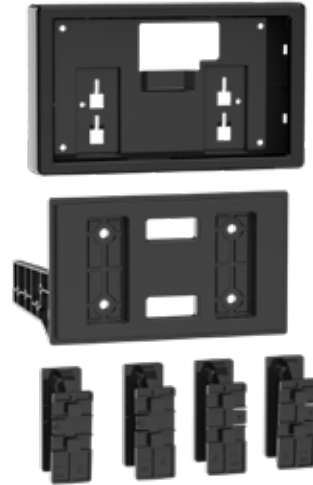

107-UN02



Universal Floating Mount Kit Pioneer 6.8" MODULAR Radios

- Engineered specifically for 6.8" Pioneer Modular Solutions Receivers like DMH-C2550NEX and DMH-C2500NEX
- See radio manufacturer for current models
- A complete housing encases the Pioneer 6.8" modular radios
- High polished processing provides a look to match both the aftermarket radio and factory finish



108-UN02

UNIVERSAL Floating Mount

Designed specifically for the Pioneer DMH-C5500NEX 8" radio

- A universal solution to install a Pioneer DMH-C5500NEX 8" radio with a separate screen and chassis into just about anything
- A complete housing encases the Pioneer's 8" screen
- Designed to "float" the Pioneer 8" screen in front of a vehicle's original radio location using the case and bracket combination
- A series of brackets provide the ability to easily mount the radio's chassis into the radio/pocket location of 250+ existing Metra Double-DIN kits for 1990 to current vehicle applications.



109-UN02



Universal Floating Mount Kit Pioneer 9" Radios

- Designed specifically for the 9" Pioneer® Modular Solutions Receiver (DMH-WC6600NEX) Radio
- See radio manufacturer for current models
- A complete housing encases the Pioneer 9" screen
- High polished processing provides a look to match both the aftermarket radio and factory finish



MULTI-KIT GUIDE

99-1004

HONDA

PASSPORT 1998-2002

ISUZU

AMIGO 1998-2000

RODEO 1998-2004

RODEO (Sport) 2001-2003

95/99-2001

BUICK

CENTURY 1997-2005

LE SABRE 1995-2005

PARK AVENUE 1995-2005

RAINIER 2004-2007

REGAL 1995-2004

RENDEZVOUS 2002-2007

RIVIERA 1996-1999

ROADMASTER 1995-1996

SKYLARK 1996-1998

CADILLAC

ESCALADE/EXT 2003-2006

CHEVROLET

AVALANCHE 2003-2006

BLAZER 2002-2005

BLAZER (Double-DIN) 2002-2002

CAVALIER 2000-2005

COLORADO 2004-2012

EXPRESS VAN 2001-2007

IMPALA 2000-2005

MALIBU 2001-2003

MALIBU CLASSIC 2004-2005

MONTE CARLO 2000-2005

SSR 2003-2006

S-10 (Double-DIN) 2002-04

SILVERADO (All) 2003-2006

SILVERADO (Classic) 2007

SUBURBAN 2003-2006

TAHOE 2003-2006

TRAILBLAZER 2002-2009

VENTURE 2000-2005

GMC

CANYON 2004-2012

ENVOY 2002-2009

SAVANA 2001-2007

SIERRA 2003-2006

SIERRA (Classic) 2007

SONOMA (Double-DIN) 2002-04

YUKON/DENALI/XL 2003-06

HUMMER

H2 2003-2007

ISUZU

ASCENDER 2003-2008

I-SERIES 2006-2008

OLDSMOBILE

ACHIEVA 1996-1998

ALERO 1999-2004

AURORA 1995-2003

BRAVADA 1998-2004

CUTLASS 1997-1999

CUTLASS SUPREME 1995-97

EIGHTY-EIGHT 1994-1999

INTRIGUE 1998-2002

LSS 1996-1999

NINETY-EIGHT 1994-1996

REGENCY 1997-1998

SILHOUETTE 2000-2004

PONTIAC

AZTEC 2001-2005

BONNEVILLE 2000-2005

GRAND AM 2001-2005

MONTANA 2000-2005

SUNFIRE 2000-2005

99-2003

BUICK

CENTURY 1997-2005

LE SABRE 1995-2005

PARK AVENUE 1995-2005

REGAL 1995-2004

RENDEZVOUS 2002-2007

RIVIERA 1996-1999

ROADMASTER 1995-1996

SKYLARK 1996-1998

CADILLAC

ESCALADE/EXT 2003-2006

FLEETWOOD/BROUGHAM

1990-1996

CHEVROLET/GEO

AVALANCHE 2003-2006

BLAZER 2002-2005

CAVALIER 2000-2005

EXPRESS VAN 2001-2007

COLORADO 2004-2012

IMPALA 2000-2005

MALIBU 2001-2003

MALIBU CLASSIC 2004-2005

METRO 1992-2001

MONTE CARLO 2000-2005

S-10 2002-2004

SILVERADO 2003-2006

SILVERADO CLASSIC 2007

SSR 2003-2006

SUBURBAN 2003-2006

TAHOE 2003-2006

TRACKER 1992-2004

TRAILBLAZER 2002-2010

VENTURE 2000-2005

GMC

CANYON 2004-2012

ENVOY 2002-2009

SAVANA 2001-2007

SIERRA 2003-2006

SIERRA CLASSIC 2007

SONOMA 2002-2004

YUKON/DENALI/XL 2003-06

HUMMER

H2 HUMMER 2003-2007

ISUZU

ASCENDER 2003-2008

I-280/I-350 2006-2007

I-290/I-370 2007-2008

OLDSMOBILE

ACHIEVA 1996-1998

ALERO 1999-2004

AURORA 1995-2003

BRAVADA 1998-2004

CUTLASS 1997-1999

CUTLASS SUPREME*1995-97

EIGHTY-EIGHT 1994-1999

INTRIGUE 1998-2002

LSS* 1996-1999

NINETY-EIGHT 1994-1996

REGENCY* 1997-1998

SILHOUETTE 2000-2004

PONTIAC

AZTEC 2001-2005

BONNEVILLE 2000-2005

GRAND AM 2001-2005

MONTANA 2000-2005

SUNFIRE 2000-2005

SUZUKI

AERIO 2002

ESTEEM 1995-2003

SIDEKICK 1992-1998

SWIFT 1995-2001

VITARA 1999-2004

GRAND VITARA 1999-2002

95/99-2009

BUICK

CENTURY 1997-2005

LE SABRE 1995-2005

PARK AVENUE 1995-2005

REGAL 1995-2004

RENDEZVOUS 2002-2007

RIVIERA 1996-1999

ROADMASTER 1995-1996

SKYLARK 1996-1998

CADILLAC

ESCALADE/EXT 2003-2006

FLEETWOOD/BROUGHAM

1990-1996

ELDORADO 1992-1995

SEVILLE 1992-1995

CHEVROLET

AVALANCHE 2003-2006

BLAZER 2002-2005

CAVALIER 2000-2005

COLORADO 2004-2012

EXPRESS 2001-2007

IMPALA 2000-2005

MALIBU 2001-2003

MALIBU CLASSIC 2004-2005

METRO 1995-2001

MONTE CARLO 2000-2005

SSR 2003-2006

S-10 (DOUBLE-DIN) 2002-2004

SILVERADO 2003-2006

SILVERADO CLASSIC 2007

SUBURBAN 2003-2006

TAHOE 2003-2006

TRACKER 1992-2004

TRAILBLAZER 2002-2009

VENTURE 2000-2005

GMC

CANYON 2004-2012

ENVOY 2002-2009

SAVANA 2001-2007

SIERRA 2003-2006

SIERRA CLASSIC 2007

SONOMA 2002-2004

YUKON/DENALI/XL 2003-06

HONDA

PASSPORT 1998-2002

HUMMER

H2 2003-2007

ISUZU

ASCENDER 2003-2008

AIMGO 1998-2000

RODEO 1998-2004

RODEO SPORT 2001-2003

I-SERIES 2006-2008

OLDSMOBILE

ACHIEVA 1996-1998

ALERO 1999-2004

AURORA 1995-2003

BRAVADA 1998-2004

CUTLASS 1997-1999

CUTLASS SUPREME 1995-97

EIGHTY-EIGHT 1994-1999

INTRIGUE 1998-2002

LSS 1996-1999

NINETY-EIGHT 1994-1996

REGENCY 1997-1998

SILHOUETTE 2000-2004

PONTIAC

AZTEC 2001-2005

BONNEVILLE 2000-2005

GRAND AM 2001-2005

MONTANA 2000-2005

SUNFIRE 2000-2005

SUZUKI

AERIO 2002

ESTEEM 1995-2003

SIDEKICK 1992-1998

SWIFT 1995-2001

VITARA 1999-2004

TOYOTA

MATRIX 2003-2004

99-2011

BUICK

CENTURY 1997-2005

LE SABRE 1996-2005

PARK AVENUE 1995-2005

RAINIER 2004-2007

REGAL 1995-2004

RENDEZVOUS 2002-2007

RIVIERA 1996-1999

ROADMASTER 1995-1996

SKYLARK 1996-1998

CADILLAC

BROUGHAM 1990-1992

ELDORADO 1992-1995

ESCALADE 2003-2006

FLEETWOOD 1990-1996

SEVILLE 1992-1995

CHEVROLET

AVALANCHE 2003-2006

BLAZER 2002-2005

CAVALIER 2000-2005

CAVALIER 2000-2000

COLORADO 2004-2012

EXPRESS VAN 2001-2007

IMPALA 2000-2005

MALIBU 2001-2003

OLDSMOBILE

BRAVADA 1998-2004
SILHOUETTE 2000-2004

PONTIAC

AZTEC 2001-2005
BONNEVILLE 2000-2005
GRAND AM 2001-2005
MONTANA 2000-2005
SUNFIRE 2000-2005

95/99-330Z

CHEVROLET

COBALT 2005-2010
EQUINOX 2005-2006
HHR 2006-2011
MALIBU 2004-2007
MALIBU 2008-2012

PONTIAC

G5 2005-2009
G6 2005-2010
SOLSTICE 2006-2009
TORRENT 2006

SATURN

AURA 2007-2009
ION 2006-2007
SKY 2006-2007
VUE 2006-2007

95/99-330S

BUICK

LUCERNE 2006-2011
ENCLAVE 2008-2011

CHEVROLET

IMPALA 2006-2013
MONTE CARLO 2006-2007
AVALANCHE 2007-2013
SILVERADO 2007-2013
SILVERADO 2500/3500

2007-2014

SUBURBAN 2007-2011

TAHOE 2007-2011

GMC

ACADIA 2007-2011
SAVANA 2008-2011
SIERRA 2007-2011
YUKON 2007-2014

HUMMER

HZ 2008-2009

PONTIAC

TORRENT 2007-2009

SATURN

OUTLOOK 2007-2010
VUE 2008-2010

SUZUKI

XL7 2007-2009

99-3400

CHEVROLET

SPECTRUM 1985-1989

GEO

PRIZM 1989-1992

SPECTRUM 1989

STORM (Double-DIN) 1990-1993

ISUZU

AMIGO 1991-1994

I-MARK 1985-1991

IMPULSE 1990-1993

PICKUP 1988-1995

RODEO 1992-1995

STYLUS 1990-1993

TROOPER 1989-1991

HONDA

PASSPORT 1994-1995

99-4000/99-4544

99-4545/99-4500

99-4503/99-4504

99-4505/99-4012

99-4644/99-4700

• NOTE: THESE APPS

REQUIRE THE USE OF

METRA KIT #99-4000

BUICK

CENTURY 1982-1996

ELECTRA 1984-1990

ESTATE WAGON 1984-1990

LE SABRE 1984-1994

PARK AVENUE 1984-1994

REATA 1990-1991

REGAL 1984-1987

RIVIERA 1983-85, 1990-95

ROADMASTER 1991-1994

SKYHAWK 1982-1989

SKYLARK 1983-1995

SOMERSET 1986-1987

CADILLAC

CIMARRON 1982-1988

COUPE DE VILLE 1985-93

ELDORADO 1984-1991

FLEETWOOD 1985-1989

SEVILLE 1984-1991

CHEVROLET

ASTRO 1985-1995

ASTRO 1996-2005

BERETTA 1991-1996

BLAZER (Full Size) 1989-1991

BLAZER 1995-1997

(USE WITH 02-3043)

BLAZER 1998-2001

CAMARO 1982-1992

CAMARO 1997-2002

CAPRICE/IMPALA

1985-1993 (1985-1990

MODELS, USE

WITH 02-3032)

CAPRICE 1994-1996

CAVALIER 1982-1994

CAVALIER 1995-1999

CELEBRITY 1982-1990

CITATION II 1985

CORSICA 1991-1996

CORVETTE 1984-1989

CORVETTE 1997-2004

EL CAMINO 1985-1988

EXPRESS 1996-2000

IMPALA 1994-1996

LUMINA 1990-1994

LUMINA 1995-2001

LUMINA APV 1990-1996

MALIBU 1997-2000

MONTE CARLO 1986-1988

MONTE CARLO 1995-1999

NOVA 1985-1988

PICKUP 1995-2002

S-10 BLAZER 1982-1994

S-10 PICKUP 1982-1993

S-10 PICKUP 1994-1997

(USE WITH 02-3043)

S-10 PICKUP 1998-2001

SUBURBAN 1989-1991

SUBURBAN 1995-2002

TAHOE 1995-2002

VENTURE 1997-1999

GMC

JIMMY (Full Size) 1989-1991

JIMMY 1995-1997

(USE WITH 02-3043)

JIMMY 1998-2001

PICKUP (Full Size) 1995-2002

S-10 JIMMY 1982-1994

S-15 PICKUP/SONOMA 1982-1993

SAFARI 1985-1995

SAFARI 1996-2003

SIERRA 1995-2002

SONOMA 1994-1997

(USE WITH 02-3043)

SONOMA 1998-2001

SUBURBAN 1989-1991

SUBURBAN 1995-2002

VAN 1988-1995

VAN 1996-2000

YUKON 1995-2002

OLDSMOBILE

ACHIEVA 1992-1995

BRAVADA 1991-1994

BRAVADA 1996-1997

(USE WITH 02-3043)

CUTLASS CALAIS 1984-1991

CUTLASS CIERA 1982-1996

CUTLASS SUPREME 1984-1994

DELTA 88 1986-1988

EIGHTY-EIGHT 1989-1993

FIRENZA 1982-1988

NINETY-EIGHT 1984-1993

OMEGA 1983-1984

SILHOUETTE 1990-1996

SILHOUETTE 1997-1999

TORNADO 1982-1992

TOURING SEDAN 1988-1993

PONTIAC

6000 1982-1991

BONNEVILLE 1982-1993

BONNEVILLE 1994-1999

FIRO 1984-1988

FIREBIRD 1982-1993

FIREBIRD 1993-2002

GRAND AM 1985-1995

GRAND AM 1996-2000

GRAND PRIX 1985-1987;

1990-1993

GRAND PRIX 1994-2003

MONTANA 1999

PARISIENNE 1984-1986

SAFARI WAGON 1987-1989

SUNBIRD/J2000 1982-1988

SUNFIRE 1995-1999

TRANS AM 1993-2002

TRANS SPORT APV 1990-1996

TRANS SPORT 1997-1998

SATURN

SATURN 1991-1994

95/99-5026

FORD

EXPEDITION 2003-2006

EXPLORER 2002-2005

MUSTANG 2001-2004

LINCOLN

AVIATOR 2003-2005

AVIATOR 2003-2003

NAVIGATOR 2003-2006

MERCURY

MOUNTAINEER 2002-2005

99-5027

FORD

CROWN VICTORIA 1995-2011

ECONOLINE FULL SIZE VAN

1997-2008

ESCAPE 2001-2007

EXPEDITION 2003-2006

EXPLORER 1995-2005

F-150 1997-2004

F-250/350/450/550 1999-2004

MUSTANG 2001-2004

RANGER 1995-2011

LINCOLN

AVIATOR 003-2005

BLACKWOOD 2001-2003

CONTINENTAL 1995-1997

MARK VIII 1996-1998

NAVIGATOR 1997-2006

TOWN CAR 1995-2002

MAZDA

B-SERIES PICKUP 1998-2009

B2300/B3000/B4000

1995-1997

MERCURY

GRAND MARQUIS 1995-2010

MARAUDER 2003-2004

MARINER 2005-2007

MOUNTAINEER 1997-2005

99-5510

AMC

ALLIANCE 1983-1987

ENCORE 1983-1987

GTA 1983-1987

FORD

AEROSTAR 1985-1997

ASPIRE 1994-1997

BRONCO 1987-1996

BRONCO II 1983-1990

COUNTRY SQUIRE 1979-1991

ECONOLINE 1992-1996

ESCORT/EXP 1985-1996

EXPLORER 1991-1994

F-SERIES 1987-1996

FESTIVA 1988-1993

LTD/CROWN VICTORIA 1979-1991

MUSTANG 1994-2000

PROBE 1993-1997

RANGER (MINI) 1985-1994

TAURUS 1986-1995

TEMPO 1989-1994

THUNDERBIRD 1983-1997

WINDSTAR 1995-1998

JEEP

CHEROKEE XJ 1984-1996

COMMANCHE 1986-1992

GRAND WAGONEER 1986-92

WAGONEER 1984-1996

WRANGLER 1984-1996

LINCOLN

CONTINENTAL 1985-1994

MULTI-KIT GUIDE

ALL99-5510

APPLICATIONS PLUS:

FORD

ECONOLINE 1975-1991
BRONCO 1980-1986
F-SERIES 1980-1986
TEMPO 1985-1988

MERCURY

TOPAZ 1985-1988

99-580Z

FORD

CROWN VICTORIA 1995-2009
ECONOLINE 1997-2008
ESCAPE 2001-2007
EXCURSION 2000-2005
EXPEDITION 1997-2002
EXPLORER 1995-2001
F-150 PICKUP 1997-2004
F-250/F-550 1999-04
RANGER 1995-2011
WINDSTAR 1999-2003

LINCOLN

BLACKWOOD 2001-2003
CONTINENTAL 1995-1997
MARK VIII 1996-1998
NAVIGATOR 1997-2002
TOWN CAR 1995-2002

MAZDA

B-SERIES PICKUP 1995-09

MERCURY

GRAND MARQUIS 1995-2010
MARAUDER 2003-2004
MARINER 2005-2007
MOUNTAINEER 1997-2001

99-5804

FORD

CROWN VICTORIA 1995-2011
ECONOLINE 1997-2008
ESCAPE 2001-2007
EXCURSION 2000-2005
EXPEDITION 1997-2002
EXPLORER 1995-2001
EXPLORER SPORT TRAC
2001-2005

F-150 1997-2003

F-150 HERITAGE 2004

F-250 1998-2004

F-350 1999-2004

F-450 1999-2004

F-550 1999-2004

F-650 2000-2010

F-750 2000-2010

RANGER 1995-2011

WINDSTAR 1999-2003

LINCOLN

BLACKWOOD 2002
CONTINENTAL 1995-1997
MARK 8 1995-1998
NAVIGATOR 1997-2002
TOWN CAR 1995-2002

MAZDA

B-SERIES 1995-2009

MERCURY

COUGAR (WITH 6 DISC IN-
DASH) 2000-2002
GRAND MARQUIS 1995-2011
MARAUDER 2003-2004
MARINER 2005-2007
MOUNTAINEER 1997-2001

99-581Z

FORD

ESCAPE W/FACTORY NAV 08
EDGE 2007-2010
F-150 2004-2008
FREESTAR 2004-2007
MUSTANG 2005-2009
FIVE HUNDRED 2005-2007
FREESTYLE 2005-2007
FOCUS 2005-2007
F SERIES SUPER DUTY 2005-
2011

FUSION 2006-2009

EXPLORER 2006-2010

EXPLORER SPORT TRAC

2007-2010

LINCOLN

MARK LT 2006-2008

MX WITH FACTORY NAV

2007-2010

NAVIGATOR WITH FACTORY NAV

2007-2011

MERCURY

MILAN 2006-2008

MONTEREY 2004-2007

MOUNTAINEER 2006-2010

MONTEGO 2005-2007

SABLE 2008-2009

95-5817

FORD

CROWN VICTORIA 1995-2009

ECONOLINE 1997-2008

ESCAPE 2001-2007

EXCURSION 2000-2005

EXPLORER 1995-2001

EXPLORER SPORT TRAC

2001-2005

F-650/750 2000-2010

F-SERIES SUPER DUTY

1999-2004

RANGER 1995-2011

WINDSTAR 1999-2003

LINCOLN

CONTINENTAL 1995-1997

MARK VIII 1996-1998

TOWN CAR 1995-2002

MAZDA

B-SERIES 1995-2009

MERCURY

GRAND MARQUIS 1995-2010

MARAUDER 2003-2004

MOUNTAINEER 1997-2001

MARINER 2005-2007

95-5818

FORD

F-150 1997-2004

EXPEDITION 1997-2002

SUPERDUTY 1999-2004

F-650 2005-2008

LINCOLN

NAVIGATOR 1997-2002

BLACKWOOD 2001-2003

98-9001/98-9002

98-9003

THE 9000 SERIES POCKETS

WILL MOUNT INTO THE METRA

KITS LISTED BELOW. REFER

TO THE INDIVIDUAL KITS

FOR MORE APPLICATION

INFORMATION

99-2011

99-2022B

99-2022BR

99-2023B

99-2023BR

99-3012G

99-3014GM

99-3045

99-3045G

99-3108

99-3309B

99-3310B

99-3311B

99-5028

99-5827B

99-5827BC

99-5828CH

99-5829CH

99-5830B

99-6514B

99-6517HG

99-6518B

99-6520B

99-6521B

99-7014B

99-7014HG

99-7015CHG

99-7346B

99-7347B

99-7348B

99-7349B

99-7349BC

99-7350B

99-7350BC

99-7352B

99-7353CH

99-7354B

99-7355B

99-7356B

99-7357HG

99-7521B

99-7522B

99-7522BC

99-7523S

99-7524B

99-7612A

99-7612AC

99-7612B

99-7612BC

99-7616

99-7617CHG

99-7618G

99-7619

99-7802CH

99-7803G

99-7803GC

99-7804B

99-7805CH

99-7806B

99-7881G

99-7882B

99-8158G

99-8159S

99-8160G

99-8231

99-8233B

99-8235B

99-8235CHG

99-8237S

99-8240B

99-8242G

99-8243B

99-8244HG

99-8245CHG

99-8246HG

99-8300

99-8720B

99-8721B

99-8722B

99-9227

99-6229

CHRYSLER

CONCORD 1993-1997

CORDOBA 1975-1983

E-CLASS 1983-1984

FIFTH AVENUE 1979-1993

IMPERIAL LEBARON 1975

IMPERIAL 1990-1993

LASER 1984-1989

LEBARON 1977-1995

LHS 1995-1998

NEWPORT 1974-1980

NEW YORKER 1974-1996

TOWN & COUNTRY 1990-2000

DODGE

ARIES 1981-1989

ASPEN 1976-1980

VAN 1974-2003

CARAVAN 1984-2000

CHARGER 1974-1987

DAKOTA 1987-2000

DAYTONA 1984-1993

DIPLOMAT 1977-1989

DURANGO 1998-2000

DYNASTY 1988-1993

INTREPID 1993-1997

LANCER 1985-1989

MAGNUM XE 1978-1979

MIRADA 1980-1983

MONOCO 1974-1978

NEON 1995-1999

OMNI 1978-1990

PICKUP 1974-2001

RAM CHARGER 1981-1993

RAMPAGE 1982-1984

SHADOW 1987-1995

SPIRIT 1989-1995

ST. REGIS 1979-1981

024 1981-1982

600 1982-1988

EAGLE

VISION 1993-1997

JEEP

CHEROKEE 1997-2001

GRAND CHEROKEE 1996-1998

WRANGLER 1997-2002

PLYMOUTH

150/250/350 VAN 1978-1997

ACCLAIM 1989-1995

CARAVELLE 1985-1988

FURY 1975-1978

GRAN FURY 1978-1989

HORIZON 1984-1990

NEON 1995-1999

RELIANT 1981-1989

SCAMP 1983

SUNDANCE 1987-1994

TC3 1978-1982

TRAILDUSTER 1975-1981

TURISMO 1983-1987

VOLARE 1976-1980

VOYAGER 1984-2000

99-6500

CHRYSLER

CONCORD 1993-1997

CORDOBA 1975-1983

SEBRING 2007-2010
TOWN & COUNTRY 2008-2013
DODGE
AVENGER 2007-2013
CALIBER 2009-2012
GRAND CARAVAN 2008-2012
CHALLENGER 2008-2013
CHARGER 2008-2010
DAKOTA 2008-2011
DURANGO 2008-2010
GRAND CARAVAN 2008-2013
JOURNEY 2009-2010
MAGNUM 2008-2008
NITRO 2007-2011
RAM PICKUP 1500 2009-2012
RAM PICKUP 2500/3500/5500/
CHASSIS CAB 2011-2012
JEEP
COMMANDER 2008-2010
COMPASS 2009-2013
GRAND CHEROKEE 2008-2010
LIBERTY 2008-2012
PATRIOT 2009-2013
WRANGLER 2007-2013
MITSUBISHI
RAIDER 2008-2009
DODGE
1500 2011-2012
RAM
2500 2011-2012
C/ V 2012-2013
DAKOTA 2011-2011
VOLKSWAGEN
ROUTAN 2009-2012
99-6700/99-6000
99-6500 APPLICATIONS
PLUS:
CHRYSLER
CIRRUS 1995-2000
SEBRING 1995-2000
SEBRING CONVERTIBLE
1996-2000
DODGE
AVENGER 1995-2000
STRATUS 1995-2000
JEEP
GRAND CHEROKEE 1993-1998
PLYMOUTH
BREEZE 1996-1999
99-7000
DODGE
COLT 1987-1992
D-50 PICKUP 1987-1993
RAIDER 1987-1991
EAGLE
SUMMIT 1988-1992
SUMMIT WAGON 1992-1996
TALON 1990-1994
MITSUBISHI
ECLIPSE 1990-1994
EXPO 1992-1995
GALANT 1985-1993
MIGHTY MAX 1987-1996
MIRAGE 1985-1992
MONTERO 1987-1991
SIGMA 1989-1990
VAN 1987-1990
PLYMOUTH
COLT VISTA 1992-1994
LASER 1990-1994
99-7001
DODGE
COLT 1993-1995
STEALTH 1991-1996
EAGLE
SUMMIT 1993-1995
SUMMIT WAGON 1992-1996
TALON 1990-1998
MITSUBISHI
DIAMANTE 1992-1996
ECLIPSE 1989-2005

GALANT 1994-1998
MIRAGE 1993-2002
MONTERO 1992-1996
MONTERO SPORT 2000-2004
3000GT 1991-1999
PLYMOUTH
COLT VISTA 1992-1994
LASER 1990-1994
99-7301
HYUNDAI
ACCENT 1995-2005
ELANTRA 1992-1995
EXCEL 1986-1994
SCOUPE 1991-1995
SONATA 1995-1998
TIBURON 1997-2001
MITSUBISHI
PRECIS 1987-1993
99-7358
HYUNDAI
ACCENT 2006-2010
ELANTRA 1996-2006
ELANTRA (RADIO DELETE)
2007-2010
SANTA FE 2001-2006
SONATA 1995-2005
TIBURON 1997-2008
TUCSON 2005-2009
XG 300/350 2001-2005
KIA
OPTIMA 2001-2006.5
(2006 EARLY PRODUCTION
MODELS ONLY)
RIO 2006-2010
SPORTAGE 2005-2010
99-7400
NISSAN
200SX 1980-1988
240SX 1989-1994
AXXESS VAN 1989-1990
HARDBODY 1986.5-1993
MAXIMA 1982-1991
PATHFINDER 1987-1993
PULSAR 1983-1990
SENTRA 1982-1990
STANZA 1982-1989
99-7401
NISSAN
200SX 1984-1988
ALTIMA 1993-1997
HARDBODY 1986.5-1997
MAXIMA 1987-1994
NX (UPPER DASH) 1991-1993
PATHFINDER 1987-1995
PULSAR 1987-1990
SENTRA 1987-1990
SENTRA (UPPER DASH)
1991-1994
STANZA 1987-1992
99-7417
INFINITI
I30 1996-1999
MERCURY
VILLAGER 1993-2002
NISSAN
200SX 1995-1998
240SX 1995-1998
ALTIMA 1998-2001
FRONTIER 1998-2004
MAXIMA 1995-1999
MAXIMA NON BOSE OR
COMFORT PKG. 2000-2003
PATHFINDER (SE MODELS)
2003-2004
PATHFINDER 1996-2002
QUEST 1993-2003
SENTRA 1995-1999
XTERRA 2000-2004
99-7500
MAZDA
323 1986-1994

626 1986-1992
929 1988-1991
B-SERIES PICKUP 1986-1993
MPV 1989-1995
MX6 1986-1992
PROTEGE 1990-1994
RX7 1986-1991
99-7501
MAZDA
323 1986-1994
626 1986-1992
929 1988-1991
B-SERIES PICKUP 1986-1993
MX5 MIATA 1990-1997
MX6 1986-1992
MPV 1989-1995
RX7 1984-1991
99-7505
MAZDA
626 2001-2002
MIATA 1998-2005
MILLENNIA 1995-2002
PROTEGE 2001-2004
TRIBUTE 2001-2006
MPV 1996-1999
99-7635
NISSAN
FRONTIER LE 2005-2008
FRONTIER S 2011-2012
FRONTIER S (King cab)
2013-2015
FRONTIER SE 2005-2008
FRONTIER SE (4-cylinder)
2009-2011
FRONTIER XE 2005-2011
PATHFINDER LE (Without nav)
2005-2007
PATHFINDER S 2006-2012
PATHFINDER S FE+ 2008-2011
PATHFINDER SE 2005-2007
PATHFINDER XE 2005
XTERRA S 2005-2008
XTERRA SE 2005-2008
XTERRA X 2006-2008
XTERRA X (RWD) 2009-2013
SUZUKI
EQUATOR 2009
99-7888
HONDA
ACCORD 1990-1993
ODYSSEY 1995-1998
PRELUDE 1988-1991
ACURA
INTEGRA 1990-2001
LEGEND 1990-1996
TL 1996-1998
VIGOR 1992-1994
ISUZU
OASIS 1996-1999
99-7890/99-7892
HONDA
ACCORD 1990-1997
ODYSSEY 1995-1998
ACURA
CL 1997-1999
INTEGRA 1990-2001
LEGEND 1990-1996
TL 1996-1998
VIGOR 1992-1994
ISUZU
OASIS 1996-1999
99-7898
ACURA
CL 1997-1999
INTEGRA 1990-2001
LEGEND 1990-1996
RSX 2002-2006 (ALL
EXCEPT "S" MODEL)
TL 1996-1998
VIGOR 1992-1994
HONDA

ACCORD 1990-2002
CIVIC 1996-2000
CIVIC SE 2005
CRV 1997-2006
ODYSSEY 1995-2004
PRELUDE 1989-2001
ISUZU
OASIS 1996-1999
99-8100
TOYOTA
CAMRY 1983-1986
CELICA 1982-1993
COROLLA 1982-1993
CRESSIDA 1985-1987
MR2 1985-1995
PICKUP 1984-1994
SUPRA 1986.5-1992
4RUNNER 1984-1989
99-8101
TOYOTA
4RUNNER 1984-2002
CAMRY 1987-1991
CELICA (GT/GTS)
1986-1989
CELICA 1990-1993
COROLLA 1984-1997
MR2 1991-1995
PICKUP 1984-2002
SUPRA 1986.5-1992
T-100 1993-1998
TACOMA 1995-2004
95-8202
TOYOTA
RAV4 2001-2005
MR2 SPIDER 2000-2003
CELICA 2000-2005
ECHO 2000-2005
HIGHLANDER 2001-2007
4RUNNER (EXCLUDING
LIMITED) 2003-2009
MATRIX 2005-2008
TUNDRA 2003-2006
SEQUOIA 2003-2007
FJ CRUISER 2007-2011
YARIS 2007-2011
SCION
(ALL MODELS) 2004-2011
SUBARU
BRZ 2013-2015
FORESTER 2009-2013
FORESTER WITH NAV 2014-2015
IMPREZA 2008-2011
IMPREZA WRX STI 2008-2014
WRX WITH NAV 2015
99-8202
TOYOTA
CELICA 2000-2005
ECHO 2000-2005
MR2 SPIDER 2000-2005
RAV-4 2001-2005
99-8300
SCION
FR-S 2013-2016
XA 2004-2006
XB 2004-2015
XD 2008-2014
TC 2005-2016
IQ 2012-2015
TOYOTA
4RUNNER (EXCLUDING LIMITED)
2003-2008
CELICA 2000-2005
COROLLA 2009-2013
ECHO 2000-2005
FJ 2007-2014
HIGHLANDER 2013
HIGHLANDER 2001-2007
MATRIX 2003-2008
SEQUOIA, 2003-2007
TUNDRA 2003-2006
MR2 SPYDER 2000-2003

RAV4 2001-2005
YARIS (3-DOOR) 2007-2010
YARIS 2012-2017
PONTIAC
VIBE 2003-2008
SUBARU
BRZ 2013-UP*
99-8900
SUBARU
BRAT PICKUP 1982-1987
DL 1981-1989
GL 1981-1989
JUSTY 1987-1994
LEGACY 1990-1994
LOYALE 1990-1994
RX 1985-1989
95/99-9011
VOLKSWAGEN
BEETLE 2012-2017
CC 2009-2017
EOS 2007-2016
GOLF, GOLF R 2010-2014
GTI 2006-2014
JETTA SPORTWAGEN 2010-2014
JETTA, JETTA GLI 2006-2018
JETTA (New dash) 2005
PASSAT 2006-UP*
R32 2007-2008
RABBIT 2007-2009
TIGUAN 2009-2017
99-9106
AUDI
A3 (With concert radio) 2006-2007
A4/S4 (With concert radio)
2000-2005
A4 1996-1999
A6 1996-1999
A8 1997-1999
TT 2000-2006
99-9222
VOLVO
100 SERIES 1973-1975
200 SERIES 1975-1993
240 SERIES 1986-1993
740 SERIES 1985-1992
760 SERIES 1988-1992
940 SERIES 1991-1995



T-SHIRT

- WHITE
- LARGE **MT-SHIRT12-L**
- X-LARGE **MT-SHIRT12-XL**
- XX-LARGE **MT-SHIRT12-XXL**



METRA POLO

- BLACK
- LARGE **MT-POLO-L**
- X-LARGE **MT-POLO-XL**



DIECUT STICKER

- 1.5" H X 5.75" W SILVER DIECUT VINYL
- MT-STICKER**



STICKERS

- FULL COLOR WITH ROUNDED CORNERS
- DIMENSIONS: 3.5" H X 8" W
- MT-WINSTKR**



LANYARD

- DAZZLE THE EYES WITH THE METRA LOGO
- DOUBLE CLIP BADGE HOLDERS
- 18 INCHES LONG & MADE OF POLYESTER

MT-LANYARD



PRY TOOL

- ANTI-SCRATCH
- ALLOWS EASY PANEL REMOVAL WITHOUT DAMAGE
- MT-PRY**



BEVERAGE OPENER KEYCHAIN

- DESIGNED FOR OPENING BOTH BOTTLES AND FLIP TOP CANS
- COMES WITH A KEY RING SO IT IS ALWAYS HANDY
- SIZE: 2 1/2" W X 1 1/2" H X 3/8" D

MT-KEY15



OUT OF STOCK CARD

- DON'T BE LEFT WITH EMPTY SHELVES
- MT-OUTOFSTCKCD**



SLATWALL HEADER

- HIGH QUALITY PRINTED LOGO GRAPHIC
- LIGHTWEIGHT RIGID MATERIAL
- DIMENSIONS: 48" X 8"

MT-SLTHDR



BANNER

- HIGH QUALITY PRINTED BANNER
- INCLUDES REINFORCED HOLES FOR HANGING
- DIMENSIONS: 48" X 24"

MT-BANNER15

Turbo **wire**

Metra's Turbo Wire Harnesses deliver quality and reliable performance for the industry's widest range of applications. All Turbo Wire Harnesses feature OEM-Quality terminals for the most secure connection between terminals and the connector - a superior design feature.

Turbo ***wire***



70-1743

CHRYSLER | PLYMOUTH | DODGE
MITSUBISHI | IMPORTS **1987-1996**

- Plugs into car harness at radio
- Provides power and allows for up to 4 speakers



71-1743

CHRYSLER | PLYMOUTH | DODGE
MITSUBISHI | IMPORTS **1987-1996**

- Plugs into OEM radio
- Provides power and allows for up to 4 speakers



70-1817

CHRYSLER | PLYMOUTH | DODGE | JEEP
1984-2005

- Plugs into car harness at radio
- Provides power and allows for up to 4 speakers

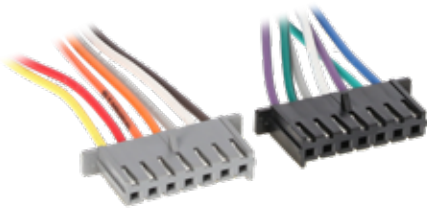

71-1817

CHRYSLER | PLYMOUTH | DODGE | JEEP
1984-2005

- Plugs into OEM radio
- Provides power and allows for up to 4 speakers



70-1818



CHRYSLER | DODGE | PLYMOUTH | JEEP
1984-2002 Amplifier Integration

- For all Infinity systems when using a 35-watt (or greater) radio
- Harness length with RCA jacks: 12"



70-6502

CHRYSLER **2002-2009**

- Plugs into car harness at radio
- Provides power and allows for up to 4 speakers



71-6502

CHRYSLER **2002-2009**

- Plugs into OEM radio
- Provides power and allows for up to 4 speakers



70-6503



CHRYSLER **2002-2009 Amplifier Integration**

- Harness length with RCA jacks: 12"

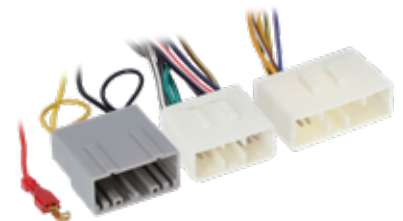

70-6504



CHRYSLER | DODGE **Durango** | **Magnum**
2005-2009 Amplifier Bypass

- Harness length: 204"
- Includes Chrysler 2002-2005 Turbo Wire - power wire only, no speaker wires



70-6506



CHRYSLER **Pacifica 2004-2008**

Amplifier Bypass

- Harness length: 204"
- Comes with 70-6502



70-6507



JEEP **Grand Cherokee 1999-2004**

Amplifier Bypass

- Harness length: 204"

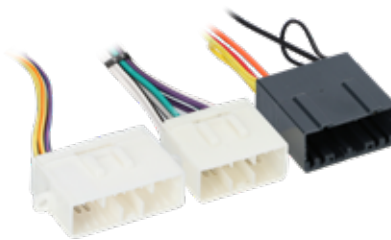

70-6510



DODGE **Ram 2004-2005** (with hands-free)

Amplifier Bypass

- Harness length: 204"
- Includes Chrysler 2002-2005 Turbo Wire - power wires only, no speaker wires



70-6512



DODGE **Ram 1500 2002-2005**

Ram 2500 | 3500 2003-2005

Amplifier Bypass

- Harness length: 204"



70-6522

CHRYSLER | DODGE | JEEP **2007-UP***

- Plugs into car harness at radio



71-6522

CHRYSLER **2007-UP***

- Plugs into OEM radio
- Provides power and allows for up to (4) speakers



71-6523

CHRYSLER | DODGE **2013-UP***

- Plugs into factory radio
- Fully terminated



71-6524

CHRYSLER | DODGE **2011-UP***

- Plugs into factory radio
- Fully terminated



70-1002

JEEP | EAGLE **1988-1996**

- Plugs into car harness at radio
- Provides power and allows for up to (4) speakers



71-1002

JEEP | EAGLE **1988-1996**

- Plugs into OEM radio
- Provides power and allows for up to (4) speakers



70-1768



LINCOLN | MERCURY **1986-1993**

Amplifier Integration

- Designed for the Ford vehicles that have the common ground amplified systems with the “football style” amplifier
- The factory harness will have the 8-way black rectangle plug with only 5 wires on it and includes RCAs

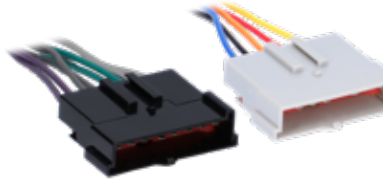

70-1770

FORD | LINCOLN | MERCURY | MAZDA
1985-2004

- Plugs into car harness at radio
- Provides power and allows for up to (4) speakers



71-1770

FORD | LINCOLN | MERCURY | MAZDA
1985-2004

- Plugs into OEM radio
- Provides power and allows for up to (4) speakers



70-1771

FORD | LINCOLN | MERCURY | MAZDA
1998-2008

- Plugs into car harness/16-pin radio
- Provides power and allows for up to (4) speakers



71-1771

FORD | LINCOLN | MERCURY | MAZDA
1998-2008

- Plugs into OEM radio/16-pin
- Provides power and allows for up to (4) speakers



70-1772

FORD | LINCOLN | MERCURY **1982-1985**

- Plugs into car harness at radio
- Provides power and allows for up to (4) speakers

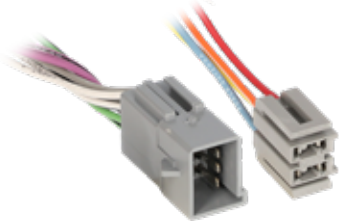

71-1772

FORD | LINCOLN | MERCURY **1982-1985**

- Plugs into OEM radio
- Provides power and allows for up to (4) speakers

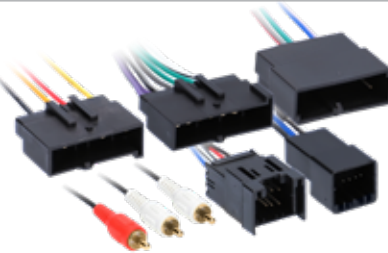

70-1776

FORD **Expedition 2003-2006**
LINCOLN **Navigator 2003-2006**

- For models with factory NAV and without THX audio
- Plugs in to car harness at radio location



70-1777

FORD **Focus 2000-2004**
MERCURY **Cougar 1999-2002**

- Plugs into car harness at radio location
- Retains Vehicle Speed Sense
- SWC wire included (for AXSWC, sold separately)
- Retains RSE audio (select vehicles)

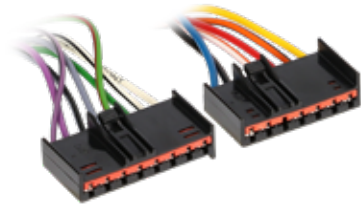

71-1777

FORD **Focus 2000-2004**
 MERCURY **Cougar 1999-2002**
 • Plugs into OEM radio



70-5510

FORD **1986-2000 Amplifier Integration**
 • For all amplified systems using a 35-watt or greater radio
 • Harness length with RCA jacks: 12"

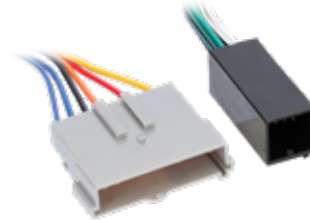

70-5511

FORD **1986-2000 Amplifier Integration**
 • Amplifier integrator system for aftermarket radios 35 watts or less
 • Plugs into car harness at radio
 • High-level speaker input



70-5512

FORD **1989-2000 Premium Sound System Amplifier Integrator Plug**
 • Plugs into pre-amplifier harness at radio (to be used with 70-1704)



70-5513

FORD **1989-2000 Premium Sound System Amplifier Integrator Plug**
 • To be used as a jumper bypassing the factory amplifier
 • Plugs into pre-amplifier harness and into speaker harness at amplifier



70-5514

FORD **1989-2000 Premium Sound System Amplifier Eliminator System**
 • Plugs into car harness (power and pre-amplifier)
 • Plugs into amplifier harness and into speaker inputs



70-5515

FORD **1989-2000 Non-Amplifier to Amplifier**
 • OEM radio integration
 • Takes OEM radios that do not need the factory amplifier and allows you to install it in Ford/Lincoln/Mercury vehicles that have the factory amplifier and bypass that amplifier so the new OEM radio will work



70-5517

FORD **1998-2003 Premium Sound**
 • 4-channel speaker input with RCA input for subwoofer



70-5518

FORD **Ranger Tremor 2002-2003 Amplifier Integration**
 • Included in Ford Ranger Tremor package
 • Tremor audio system amplifier integration
 • Comes with 70-1771 and an 8-pin harness with 2 pairs of RCA plugs



70-5519

FORD | LINCOLN | MERCURY 1998-2011

Amplifier Integration

- Plugs into car harness at radio
- 4-channel speaker input, RCA input for subwoofer



70-5520

FORD | LINCOLN | MERCURY 2003-UP*

- Plugs into car harness
- Includes (1) 24-way plug for power and speaker



71-5520

FORD | LINCOLN | MERCURY 2003-UP*

- Plugs into OEM radio
- Includes (1) 24-way plug for power and speaker
- Wire length: 7"

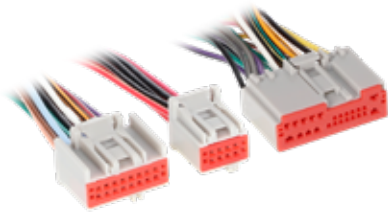

71-5520-1

FORD | LINCOLN | MERCURY 2003-UP*

- Plugs into OEM radio
- Includes (1) 24-way plug for power and speaker, (1) 8-way plug for premium sound, and (1) 16-way plug for charger and auxiliary
- Fully terminated
- Wire length: 7"

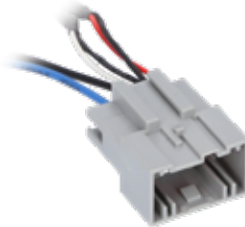

70-5520AV

FORD 2003-2006 Factory AV/DVD Retention

- Plugs into car harness at radio
- Retains factory DVD player
- Retains audio from factory overhead
- Use with 70-5520



70-5520AUX

FORD 2007-2008 AUX-In Jack Retention

- Plugs into car harness at radio
- Provides RCAs for retention of factory 3.5mm auxiliary jack

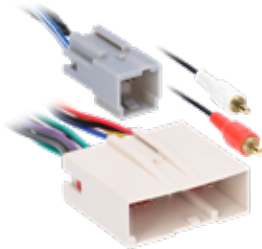

70-5521

FORD | LINCOLN | MERCURY 2003-2012

Amplifier Integration

- For amplified sound systems
- 4-channel speaker level input with RCA input for subwoofer



70-5522

FORD | LINCOLN | MERCURY 2003-2012

Subwoofer Plug Only

- For amplified sound systems
- Includes an 8-pin harness with 2 pairs of RCAs
- Designed for situations where a 70-5520 is presently used for power and (4) speakers, but missing the subwoofer input plug at the radio location



70-5523

FORD Transit Connect 2010-2012

- Plugs into car harness
- Provides power and allows for up to (4) speakers
- SWC wire included (for AXSWC)

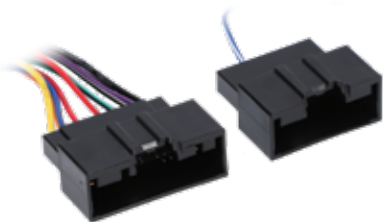

70-5524

FORD **2011-UP*** (without SYNC)

- Plugs into car harness
- Provides power and allows for up to (4) speakers
- Wire length: 7"



71-5524

FORD **2011-UP***

- Plugs into car OEM radio
- Provides power and allows for up to (4) speakers
- Fully terminated 24 & 26 pin
- Wire length: 7"



70-5600

FORD **1995-1998 Premium Sound System**

(for aftermarket radios 35-Watts or less)

- Plugs into car harness at radio
- Provides power and allows for up to (4) speakers



71-5600

FORD | LINCOLN **1995-1998** (non luxury)

Premium Sound System

- Plugs into OEM Radio
- Provides power and allows for up to (4) speakers



70-5601

FORD | LINCOLN | MERCURY **1994-1997**

- Allows the installation of an aftermarket head unit in Fords with a Luxury JBL Radio System
- Tuner bypass harness (15')
- Includes antenna extension and adapter (15')



70-5602

FORD **1986-2001 Amplifier Bypass**

- Eliminates splicing when using Metra's 70-5513 in Ford Premium sound systems
- Wire length: 15"



70-5603

FORD **1996-1998 Amplifier Integration**

- For all amplified systems using a 35-watt (or greater) radio
- Wire length: 12"



70-5605

FORD **Contour | Mustang | Ranger | Expedition | LINCOLN Navigator 1994-2000**

- Amplifier bypass harness
- Wire length: 5"



70-5701

FORD | LINCOLN | MERCURY **1998-2011**

Premium Sound

- Speaker level input with RCA input for subwoofer
- Includes harness to retain power antenna turn-on



70-5702

1

FORD | LINCOLN | MERCURY | MAZDA
1998-2003

- Premium sound systems
- Factory subwoofer integration
- Plugs into 8-way factory sub-plug harness only (for use with 70-1771)



70-5715

B

FORD Taurus | MERCURY Sable 1996-2007

- Connects aftermarket radio to factory speaker wiring in the trunk
- Includes antenna extension and adapter



70-5716

FORD Taurus | MERCURY Sable 1998-1999

- Connects 99-5715LD to 98-99 models

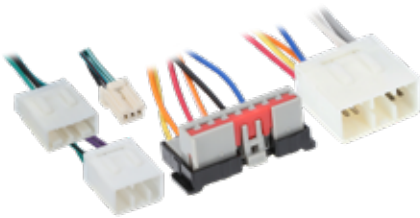

70-5720

FORD Escort ZX2 2003-2004

- Connects 99-5720 to premium sound vehicles

GENERAL MOTORS

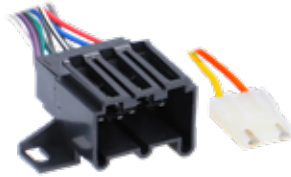

70-1677-1

GM 1973-1993

- Plugs into car harness at radio (12-pin)
- Provides power and allows for up to (4) speakers



71-1677-1

GM 1973-1993

- Plugs into OEM radio (12-pin)
- Provides power and allows for up to (4) speakers



70-1782

GEO 1985-1997 | CHEVROLET Metro
1995-1999 | Spectrum 1985-1989
HONDA Passport 1994-1995
ISUZU 1985-1995

- Plugs into car harness at radio
- Provides power and allows for up to (4) speakers



71-1782

GEO 1985-1997 | CHEVROLET Metro
1995-1999 | Spectrum 1985-1989
HONDA Passport 1994-1995
ISUZU 1985-1995

- Plugs into OEM radio
- Provides power and allows for up to (4) speakers



70-1855

B

BUICK Regal | CHEVROLET Full Size
Truck 1988-1944 | PONTIAC Grand Prix
1988-1989 | Sunbird 1989-1994

- Tuner bypass
- Wire length: 5'

GENERAL MOTORS



70-1856



CADILLAC Allante 1990-1993 | Deville 1994-1995 | Eldorado | Seville 1992-1995
Fleetwood 1991-1995 | CHEVROLET Corvette 1989-1996

- Tuner bypass
- Wire length: 204"



70-1857



CADILLAC Allante 1990-1993 | Deville 1994-1995 | Eldorado | Seville 1992-1995
Fleetwood 1991-1995 | CHEVROLET Corvette 1989-1996

- Tuner bypass and Bose amplifier integration harness
- Wire length: 204"



70-1858

GM 1988-2005
• Plugs into car harness at radio (21-pin)



71-1858

GM 1988-2005
• Plugs into OEM radio (14-pin only)
• Provides power and allows for up to (4) speakers



70-1858-1

GM 1988-2005
• Plugs into OEM radio (20-pin)
• Provides power and allows for up to (4) speakers
• Includes additional fully terminated 6-pin section



71-1858-1

GM 1988-2005
• Plugs into car harness (20-pin)
• Provides power and allows for up to (4) speakers
• Includes additional fully terminated 6-pin section

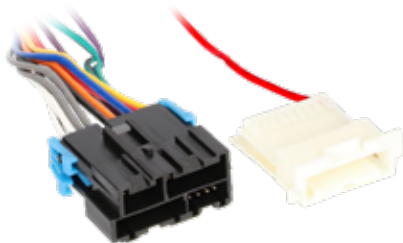

70-1859

GM Full-Sized Trucks 1995-2002
(with Factory Amplified Systems)
• Plugs into car harness at radio location
• Includes additional 9-pin to activate factory amplifier



70-2001

GM 1994-2004
• Plugs into car harness at radio (32-pin)
• Provides power and allows for up to (4) speakers



71-2001

GM 1994-2004
• Plugs into OEM radio (32-pin)
• Provides power and allows for up to (4) speakers



70-2003

GM **1998-2006** | KIA **Sorento EX 2003-2006**
 TOYOTA **Matrix 2003-2004** | HYUNDAI **Santa Fe with Monsoon 2003-2006**

- Plugs into car harness at radio (24-pin)
- Provides power and allows for up to (4) speakers



71-2003-1

GM **1998-2006**

- Plugs into OEM radio (24-pin)
- Provides power and allows for up to (4) speakers
- Fully terminated



70-2003T

GM **2000-2006 Class II T-Harness**

- Relocates factory radio for retention (24-pin) of Class II data features (to be used with SP-2003)



70-2005

GM **2000-2006** (with OnStar® System)

- Interface harness to be used with the 70-2003T Class II T-harness
- Harness and SP-2003 door chime speaker needed to hear audio from OnStar®



70-2021

CHEVROLET **Impala | Monte Carlo 2000-2001**

Amplifier Bypass Jumper

- Bypasses amplifier and creates a loop
- No rewire is needed when installing new radio and removing factory amplifier



70-2054

GM **1998-2004 Amplifier Bypass**

- Wire length: 204"
- Must have RPO code Y91



70-2057

GM **2014-UP* MOST®**

- Plugs into output of OEM amplifier harness (21-pin)
- Wire length: 72" with color coded leads

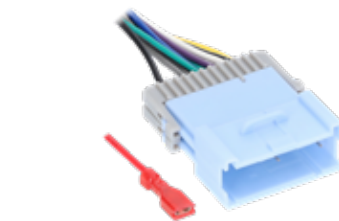

70-2103

CHEVROLET **Malibu 2004-2006** | PONTIAC **G6 2005-2006**

- Plugs into car harness
- Harness does not supply an ignition source and all of the factory warning chimes will no longer function
- OnStar® features will also be lost



71-2103-1

GM **2004-2007**

- Plugs into car harness at radio (32-pin)
- Provides power and allows for up to (4) speakers

GENERAL MOTORS+DAEWOO



70-2103T

CHEVROLET **Aveo** | PONTIAC **G3 2007-2009**

- Allows user to temporarily connect factory radio without removing aftermarket radio
- With the factory radio connected, vehicle personalization features can be changed using the controls on the factory radio



70-2104

GM **2006-2012** (without OnStar®)

- Plugs into car harness
- Provides power and allows for up to (4) speakers



71-2104

GM **2006-2012**

- Plugs into OEM radio
- Provides power and allows for up to (4) speakers



70-2105

GM | SUZUKI **2006-UP***

- Does not retain any warning chimes or OnStar®
- No 12volt accessory output



71-2105

GM | SUZUKI **2006-UP*** (without OnStar®)

- Plugs into car harness
- Provides power and allows for up to (4) speakers



71-2106

GM **2010-2017**

- Plugs into car OEM radio
- Provides power and allows for up to (4) speakers
- Wire length: 7"
- Fully terminated 44-pin



71-2107

GM **Full Size Trucks and SUVs 2015-UP***

- Plugs into factory radio
- Fully terminated



71-2108

GM **2016-UP***

- Plugs into OEM radio



DAEWOO



70-8405

DAEWOO **1999-2002**

- Plugs into car harness at radio
- Provides power and allows for up to (4) speakers



70-2002

SATURN 2000-2005

- Plugs into car harness at radio (24-pin)
- Provides power and allows for up to (4) speakers



71-2002

SATURN 2000-2005

- Plugs into OEM radio (24-pin)
- Provides power and allows for up to (4) speakers



70-2102

SATURN 2004-2005

- Plugs into car harness at radio
- Provides power and allows for up to (4) speakers



71-2102

SATURN 2004-2005

- Plugs into OEM radio
- Provides power and allows for up to (4) speakers



70-2202

SATURN Ion | Vue 2006-2007

- Used when replacing the factory radio
- Provides power and allows for up to (4) speakers



71-2202

SATURN Ion | Vue 2006-2007

- Use when OEM harness in the dash is damaged and replacement is needed



71-9600

HARLEY-DAVIDSON 1998-2013

- Plugs into OEM radio
- Wire length: 7" with color coded leads



71-9700

HARLEY-DAVIDSON 2014-UP*

- Plugs into OEM radio
- Wire length: 7" with color coded leads

HONDA



70-9800



HARLEY-DAVIDSON **Touring Models 1998-2013**

- Plugs into car harness at factory radio location
- Pre-wired for AXSWC for handlebar controls (sold separately)



70-1388

HONDA 1982-1985

- Plugs into car harness at radio
- Provides power and allows for up to (4) speakers



70-1720

HONDA | ACURA 1986-1998

- Plugs into car harness at radio
- Provides power and allows for up to (4) speakers



71-1720

HONDA | ACURA 1986-1998

- Plugs into OEM radio
- Provides power and allows for up to (4) speakers

HONDA



70-1720T

HONDA **Civic 1996-1998**

- Plugs into car harness at radio
- Provides power and allows for up to (4) speakers
- Retains factory keyless entry



70-1721

HONDA | ACURA | SUZUKI **1998-2013**

- Plugs into car harness at radio
- Provides power and allows for up to (4) speakers



71-1721

HONDA | ACURA | SUZUKI **1998-2013**

- Plugs into OEM radio
- Provides power and allows for up to (4) speakers



70-1722

HONDA **Civic 2006-2010** (excluding DX model)

- Plugs into car harness at radio
- Provides power and allows for up to (4) speakers
- Wire length: 7"



71-1722

HONDA **Civic 2006-2010** (excluding DX model)

- Plugs into OEM radio
- Provides power and allows for up to (4) speakers



70-1724

HONDA **Accord 1993-1994**

- **Amplifier Integration**
- For amplified sound system



70-1725

ACURA **RSX 2002-2006**

Amplifier Integration

- Amplifier integration for Bose® systems
- Includes RCAs

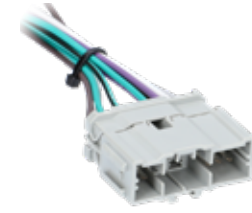

70-1726

HONDA **Element 2003-2011**

Amplifier Bypass

- Wire length: 204"



70-1727

HONDA **Civic 2006-2011**

- Bypass factory amplifier
- Premium sound system



70-1729

HONDA **2008-UP***

- Plugs into car harness at radio



71-1729

HONDA **2008-UP***

- Plugs into OEM radio
- Fully terminated



70-1730

HONDA **2008-2015** (with Premium Sound)

- Plugs into car harness at radio
- Retains factory amplified system
- Features RCAs instead of speaker wires
- Wire length: 12" with RCA jacks



70-1731

HONDA 2016-UP*

- Plugs into car harness at radio
- Provides power and allows for up to (4) speakers
- Factory backup camera connections
- Pre-wired for AXSWC (sold separately)



71-1731

HONDA 2016-UP*

- Plugs into OEM radio
- Provides power and allows for up to (4) speakers



70-7863

HONDA Element 2003-2011 (EX & SC Models)

Premium Sound Integration

- Includes factory AUX in retention plugs
- Retains OEM amplifier and subwoofer



70-7712

HONDA Passport 1996-2002

ISUZU 1995-2004

- Plugs into car harness at radio
- Provides power and allows for up to (4) speakers



71-7712

HONDA Passport 1996-2002

ISUZU 1995-2004

- Plugs into OEM radio
- Provides power and allows for up to (4) speakers



HYUNDAI+KIA

70-1004

HYUNDAI | KIA 2005-2010

- Plugs into car harness
- Provides power and allows for up to (4) speakers



71-1004

HYUNDAI | KIA 2005-2010

- Plugs into factory radio
- Fully terminated
- Provides power and allows for up to (4) speakers



70-1736

HYUNDAI 1986-1994

- Plugs into car harness at radio
- Provides power and allows for up to (4) speakers



71-1736

HYUNDAI 1986-1994

- Plugs into OEM radio
- Provides power and allows for up to (4) speakers



70-7300

HYUNDAI 1991-2002

- Plugs into car harness
- Provides power and allows for up to (4) speakers



71-7300

HYUNDAI 1991-2002

- Plugs into OEM radio
- Provides power and allows for up to (4) speakers
- Fully terminated



70-7301

HYUNDAI 1999-2006

- Plugs into car harness at radio
- Provides power and allows for up to (4) speakers



71-7301

HYUNDAI **1999-2006**

- Plugs into OEM radio
- Provides power and allows for up to (4) speakers



70-7302

HYUNDAI **Santa Fe** | KIA **Sorento**
2007-2009

- Plugs into car harness at radio
- Provides power and allows for up to (4) speakers



71-7302

HYUNDAI **Santa Fe** | KIA **Sorento**
2007-2009

- Plugs into OEM radio
- Provides power and allows for up to (4) speakers



70-7303



HYUNDAI | KIA **2009-2014** (with Infinity Sound)

- Plugs into car harness at radio
- Provides power and allows for up to (4) speakers



71-7303-1

HYUNDAI | KIA **2009-2014**

- Plugs into OEM radio
- Includes 8-way from ISO and the 20-way
- Fully terminated
- Provides power and allows for up to (4) speakers



70-7304

HYUNDAI | KIA **2010-UP***

- Allows installation of aftermarket radio using factory wiring and connector
- No cutting of factory wires is necessary
- Provides power and allows for up to (4) speakers
- Plugs into car harness



71-7304

HYUNDAI | KIA **2010-UP***

- Plugs into OEM radio
- Fully terminated



70-7305



HYUNDAI | KIA **2010-2016 Amplifier Bypass for Dimension Sound Systems**

- Designed with 24" leads for aftermarket amplifier installation



70-7306



HYUNDAI | KIA **2017-UP***

- Wiring harness for installing an aftermarket radio
- Provides power and four speakers
- Retains balance and fade
- Pre-wired AXSWC harness (AXSWC sold separately)
- Retains the factory backup camera
- Designed for non-amplified models



71-7306



HYUNDAI | KIA **2017-UP* OEM Harness**

- Plugs into OEM radio
- Fully terminated

Metra
THE INSTALLER'S CHOICE

“ Metra’s Turbo Wire Harnesses deliver quality and reliable performance for the industry’s widest range of applications. All Turbo Wire Harnesses feature OEM-quality terminals for the most secure connection between terminals and the connector - a superior design feature. ”

ISUZU



70-7713



ISUZU Rodeo 2002-2003
(with factory amplifier with RCA)
• Looks like the 70-7712, but is larger
• Features RCA plugs instead of speaker wires

KIA



71-7713



ISUZU Rodeo 1995-2004
(with factory amplifier)
• Plugs into OEM radio
• Provides power and allows for up to (4) speakers



70-1003

KIA 1995-2003
• Plugs into car harness at radio
• Provides power and allows for up to (4) speakers



71-1003

KIA 1995-2003
• Plugs into OEM radio

MAZDA



70-1781

MAZDA 1986-1989
FORD Festiva 1988-1993
MERCURY Tracer 1988-1990
• Plugs into car harness at radio
• Provides power and allows for up to (4) speakers



71-1781

MAZDA 1986-1989
Truck 1986-1993
• Plugs into OEM radio
• Provides power and allows for up to (4) speakers



70-7901

MAZDA 1990-2001
• Plugs into car harness at radio
• Provides power and allows for up to (4) speakers



71-7901

MAZDA 1990-2001
• Plugs into OEM radio
• Provides power and allows for up to (4) speakers



70-7903

MAZDA 2001-UP*
• Plugs into car harness at radio
• Provides power and allows for up to (4) speakers



71-7903

MAZDA 2001-UP*
• Plugs into OEM radio

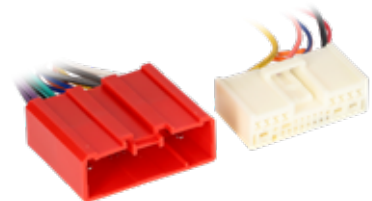

70-7903T

MAZDA CX-7 | CX-9 | RX8 2007-2015
Service Harness
• Allows user to plug in the OEM radio to adjust the clock time without disassembling dash or having to remove
• Unplugs after clock adjustment and tucks out of sight

MITSUBISHI



70-7001

MITSUBISHI **1992-2012** | DODGE **Stealth**
1994-1996

- Plugs into car harness at radio
- Provides power and allows for up to (4) speakers



71-7001

MITSUBISHI **1992-2012** | DODGE **Stealth**
1994-1996

- Plugs into OEM radio
- Provides power and allows for up to (4) speakers



70-7002



MITSUBISHI **3000GT** **1997-1999**
Diamante **1994-2002** | **Eclipse** **1995-2000**
Galant **1997-1998**

- Amplifier bypass harness
- 7' power harness, 15' amplifier bypass harness



70-7003



MITSUBISHI **1994-2007** (with Infinity System)
DODGE **Stealth** **1994-1996**

- Comes with 70-7001
- Has only power wires and no speaker wires
- DIN plug with RCA plugs



70-7004



MITSUBISHI **1994-2007** **4-Speaker with**
Amplifier Integration

- Kit comes with harnesses for amplified and non-amplified models



70-7005

MITSUBISHI **2007-UP***

- Plugs into car harness at radio
- Provides power and allows for up to (4) speakers



71-7005

MITSUBISHI **2007-UP***

- Plugs into original factory radio
- Provides power and allows for up to (4) speakers



70-1763

NISSAN **1984-1994**

- Plugs into car harness at radio
- Provides power and allows for up to (4) speakers



71-1763

NISSAN **1984-1994**

- Plugs into OEM radio
- Provides power and allows for up to (4) speakers



70-1764

NISSAN | INFINITI **1987-1994**

- Plugs into car harness at radio



70-7550

NISSAN **1995-2013**

- Plugs into car harness at radio
- Provides power and allows for up to (4) speakers



71-7550

NISSAN **1995-2013**

- Plugs into OEM radio
- Provides power and allows for up to (4) speakers



70-7551

NISSAN | INFINITI **1995-2013**

- Premium sound
- Plugs into car harness at radio
- Wire length: 12" with RCA jacks



70-7552

NISSAN **2007-UP*** | SUBARU **2008-2015**

- Plugs into car harness at radio
- Provides power and allows for up to (4) speakers



71-7552

NISSAN **2007-UP*** | SUBARU **2008-2015**

- Plugs into car harness at radio
- Provides power and allows for up to (4) speakers



70-7553

NISSAN **2007-UP***

- Plugs into car harness at radio
- For factory amplified systems
- Wire length: 12" with RCA jacks

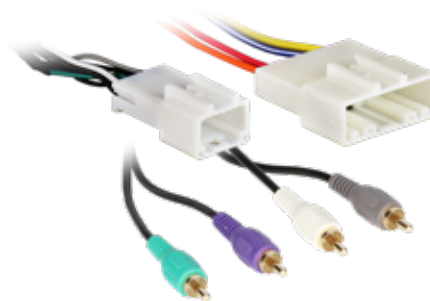

70-7554

NISSAN **2010-2016 Bose® Integration**

- Power harness included
- Color coded RCAs for factory amplifier retention
- Wire length: 12" with RCA jacks

SUBARU + SUZUKI



70-1780

SUBARU **Legacy 1990-1994** | **Justy 1987-1994**

- Plugs into car harness at radio
- Provides power and allows for up to (4) speakers



70-8900

SUBARU **Loyale 1990-1994** | **DL/GL 1985-1989**

- Plugs into car harness at radio
- Provides power and allows for up to (4) speakers



70-8901

SUBARU **1993-2013**

- Plugs into car harness at radio
- Provides power and allows for up to (4) speakers



71-8901

SUBARU **1993-2013**

- Plugs into OEM radio
- Provides power and allows for up to (4) speakers



70-8902



SUBARU **Legacy** | **Outback 2012-2014** (with premium sound)

- Plugs into car harness at radio location
- Retains AUX input
- Provides reverse wire
- Wire length: 12" with RCA jacks
- Pre-wired for the AXSWC / 2012-2013 models only (AXSWC sold separately)

SUZUKI



70-7991

SUZUKI **Swift** | **Sidekick GEO Imports 1986-1995**

- Plugs into car harness at radio
- Provides power and allows for up to (4) speakers



70-7992

SUZUKI **1995-2003**

- Plugs into car harness at radio
- Provides power and allows for up to (4) speakers



71-7992

SUZUKI **1995-2003**

- Plugs into OEM radio
- Provides power and allows for up to (4) speakers

LAND ROVER + JAGUAR + TOYOTA



70-9400



LAND ROVER **Discovery 1998-2001**

- Amplifier integration harness
- Includes VW 1980-2005 Turbo wire and a 10-way connector with RCAs



70-9401

LAND ROVER **Discovery 1999-2004**

- MERCEDES-BENZ **1999-2004** (non-amplified)
- Plugs into car harness
 - Provides power and allows for up to (4) speakers



70-1786



LAND ROVER | MERCEDES-BENZ **1991-1999**

Amplifier Integration

- 70-1784 style harness featuring RCAs instead of speaker wire
- 12volt constant wire and accessory wire are reversed from the 70-1784

JAGUAR



70-9500

JAGUAR **2002-2009**

- Plugs into car harness
- Provides power and allows for up to (4) speakers

TOYOTA



70-1398

TOYOTA **1982-1987** | DIAHATSU **1989-1992**

- Plugs into car harness at radio
- Provides power and allows for up to (4) speakers



71-1398

TOYOTA **1982-1987** | DIAHATSU **1989-1992**

- Plugs into OEM radio
- Provides power and allows for up to (4) speakers

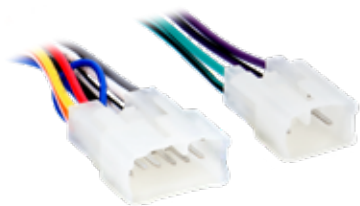

70-1761

TOYOTA | SCION | SUBARU **1987-UP***

- Plugs into car harness at radio
- Provides power and allows for up to (4) speakers

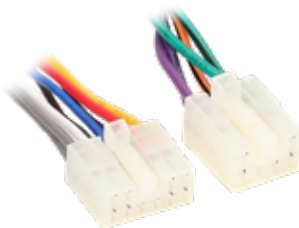

71-1761

TOYOTA | SCION | SUBARU **1987-UP***

- Plugs into OEM radio
- Provides power and allows for up to (4) speakers



70-8112



TOYOTA | LEXUS **1992-2000**

Premium Amplifier Integration

- Integrates aftermarket radio with factory amplifier (15-pin harness)
- Provides power and allows for up to (4) channels
- Plugs into car harness at radio
- Wire length: 12" with RCA jacks



71-8112

TOYOTA | LEXUS **1992-2000**

- Plugs into OEM radio
- 15-pin



70-8113

TOYOTA | LEXUS **2000-2007**

Analog Amplifier Integration

- Plugs into car harness at radio
- Retains factory analog amplifier and speakers
- Wire length: 12" with RCA jacks



71-8113

TOYOTA | LEXUS **2000-2015**

- Plugs into OEM radio
- 20-pin

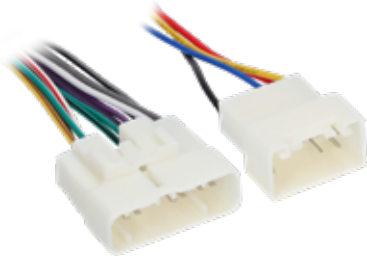

70-8116



TOYOTA **Avalon 2000-2004** | **Camry 2000-2003**
| **Land Cruiser 2000-2003 Amplifier Bypass**

- Comes with a 70-8113
- Features only power wires, no RCA plugs
- Wire length: 204"



70-8117



TOYOTA **4Runner** (including Limited) **2003-2004** |
Sienna 2004 (with JBL Sound System) | **Solara 2004**
Amplifier Bypass

- Comes with a 70-8113
- Features only power wires, no RCA plugs
- Wire length: 204"

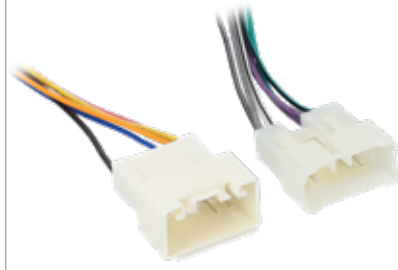

70-8121



TOYOTA **Tundra 2005-2006 Amplifier Bypass**

- Factory amplifier bypass



70-8215AMP

TOYOTA **Avalon 2005-2010 Radio Relocation**

- Relocates factory radio to retain climate display
- Requires TYTO-01 (sold separately) to retain power and amplifier retention
- Wire length: 17'

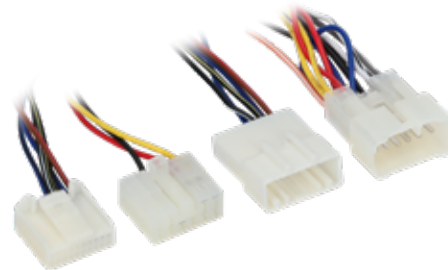

70-8215

TOYOTA **Avalon 2005-2010 Radio Relocation**

- Climate control retention
- Relocate factory radio to retain climate display
- Not for use in premium sound systems
- Includes harness for power and speakers
- Wire length: 17'

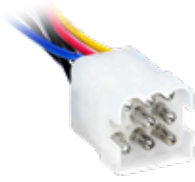

70-1119

VOLVO 1981-1992

- Plugs into car harness at radio
- Provides power and allows for up to (2) speakers



70-1120

VOLVO 240 1990-1993

- Plugs into car harness at radio
- Provides power and allows for up to (4) speakers



70-9220

VOLVO 1993-2003

- Plugs into car harness at radio
- Provides power and allows for up to (4) speakers



70-9221

VOLVO 1999-2009

- Plugs into car harness at radio
- Provides power and allows for up to (4) speakers



71-9221

VOLVO 1999-2009

- Plugs into OEM radio
- Provides power and allows for up to (4) speakers



BMW

70-8590

BMW 1991-2006

- Plugs into car harness at radio
- Provides power and allows for up to (4) speakers



71-8590

BMW 1991-2006

- Plugs into OEM radio
- Provides power and allows for up to (4) speakers



70-8591

BMW 1991-2006

- Analog amplifier integration harness
- Wire length: 12" with RCA jacks



70-9003

BMW 2001-2017

- Plugs into car harness at radio
- Provides power and allows for up to (4) speakers

AUDI + BMW + MERCEDES-BENZ + SMART + VW

BMW



71-9003

BMW | MERCEDES-BENZ | VW 2001-2017

- Plugs into OE radio
- Provides power and allows for up to (4) speakers (less accessory)



71-9003-1

BMW | MERCEDES-BENZ | VW 2001-2017

- Plugs into OE radio
- Provides power and allows for up to (4) speakers (less accessory)
- Fully populated

SMART



70-1783

SMART Fortwo 2008-2015

- Plugs into car harness at radio
- Provides power and allows for up to (4) speakers



THE INSTALLER'S CHOICE

Our Corporate Mission

To enthusiastically and aggressively approach any opportunity to utilize our braintrusts, facilities, strategies, alliances and capital for the advancement of our employees and stakeholders.

There will be no limitations as we strive to create, innovate, manufacture and deliver high quality, good value products to not only satisfy but also astonish our customers.

By following our vision and attaining high levels of honesty and integrity, we will experience the joy of competition and winning.

VW / AUDI



70-1784

VOLKSWAGEN 1980-2007

- Plugs into car harness at radio
- Provides power and allows for up to (4) speakers



71-1784

VOLKSWAGEN 1980-2007

- Plugs into OEM radio
- Provides power and allows for up to (4) speakers



70-1785

VOLKSWAGEN 1988-1998

Amplifier Integration

- Plugs into car harness at radio
- Provides power and allows for up to (4) speakers



70-1787

VW | AUDI 1993-2005

Amplifier Integration

- Amplified and Bose systems
- Uses the power wire side of the 70-1784; front speaker output only on some models
- 20-way connector (plugs into multi-colored harness in car) with RCA plugs



70-9003

BMW | MERCEDES-BENZ | VW 2001-2017

- Plugs into car harness
- Power/4-speakers



71-9003

BMW | MERCEDES-BENZ | VW 2001-2017

OEM Harness

- Plugs into OEM radio
- Power/4-speakers (less accessory)



71-9003-1

BMW | MERCEDES-BENZ | VW 2001-2017

OEM Harness

- Plugs into OEM radio
- Fully terminated
- Power/4-speakers (less accessory)



71-9006

VOLKSWAGEN 2015-UP*

- Plugs into OEM radio
- Fully terminated
- Power/4-speakers (less accessory)

SPEAKER HARNESSSES



72-1002

JEEP | EAGLE 1984-2008
• Sold as a pair



72-4500

GM | JEEP | NISSAN 1972-2013
• Sold as a pair



72-4530

GM | CHRYSLER 1996
• Sold as a pair



72-4565

GM | CHRYSLER 1982-2002
• Sold as a pair



72-4568

GM 1984-2020
• Sold as a pair



72-4569

GM 1985-1996
• Sold as a pair



72-4570

GM 1995-2006
• Sold as a pair



72-4572

GM 2010-2020
• Sold as a pair



72-5500

FORD 1985-1998
• Sold as a pair



72-5510

FORD 1982-1988
• Sold as a pair



72-5512

FORD 1987-UP*
• Sold as a pair

SPEAKER HARNESSSES



72-5600

FORD **1998-UP***
• Sold as a pair



72-5601

FORD | GM **2007-2017**
• Sold as a pair



72-5602

FORD | MAZDA **2011-UP***
• 4-position
• Sold as pair



72-6512

CHRYSLER **1992-2007**
• Sold as a pair



72-6514

CHRYSLER | DODGE **1990-UP***
• Sold as a pair

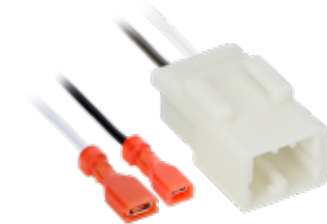

72-6514-12

CHRYSLER **1990-UP***
• Sold as a pair



72-6516



RAM **2019-2020**
• Rear panel position
• Sold as pair



72-7300

HYUNDAI | KIA **2011-UP***
• 2-position
• Sold as a pair



72-7301

HYUNDAI | KIA **2011-UP***
• 4-position
• Sold as a pair



72-7302

HYUNDAI | KIA **2016-UP***
• Sold as a pair



72-7303

HYUNDAI | KIA **2005-2020**
• Sold as a pair



72-7400

NISSAN **1982-UP***
• Sold as a pair

SPEAKER HARNESSES



72-7401

NISSAN 1994-2009
• Sold as a pair



72-7800

HONDA 1982-UP*
• Speaker-position
• Sold as a pair



72-7901

MAZDA 1990-UP*
• Sold as a pair



72-7902

MAZDA 1998-UP* CHRYSLER | DODGE | JEEP
HYUNDAI 2004-UP*
• Sold as a pair



72-8101 N

TOYOTA 1985-2009
• Sold as a pair



72-8102 N

TOYOTA 1989-2003
• Sold as a pair

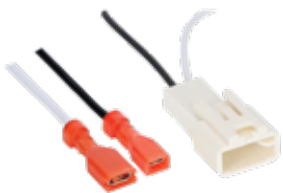

72-8104

TOYOTA 1987-UP*
• Sold as a pair



72-8105 N

TOYOTA 1995-UP*
• Sold as a pair



72-8106 N

TOYOTA 1995-UP*
• Sold as a pair



72-8107 N

TOYOTA 1998-2018
• Sold as a pair



72-8108 N

TOYOTA 2002-2004
• Wire length: 12"
• Sold as a pair



72-8109 N

TOYOTA 2018-2020
• Sold as a pair

SPEAKER HARNESSSES



72-8110



TOYOTA **2007-2019**

- Tweeter position
- Sold as a pair



72-9000



RAM | FIAT **2014-2020**

- Sold as a pair



72-9001



VOLKSWAGEN **1998-2017**

- Sold as a pair



72-9002

BMW **1999-2006** | AUDI **2000-2012**

MERCEDES-BENZ **1997-UP***

- Sold as a pair



72-9003

AUDI **1996-2001**

- Sold as a pair



72-9300

EURO | MAZDA | NISSAN **1987-2011**

- Sold as a pair



72-9301

EURO | TOYOTA | MITSUBISHI **1982-2003**

- Sold as a pair



72-9701



POLARIS **2015-UP***

- 2-pin postions
- Sold as pair



72-9702



POLARIS **2015-UP***

- 3-pin postions
- Sold as pair

PLUG & PLAY

CONNECT AFTERMARKET RADIOS TO THE CAR
FACTORY HARNESS WITH NO CUTTING,
SPlicing OR SOLDERING!



TURBO WIRE

Part Number Conversion

Model numbers represent the aftermarket radio type and corresponding Turbo Wire four digit part number suffix. For specific vehicle applications, see the Turbo Wire section of this catalog and the application chart at the back. A "universal" Smart Cable with 0001 as the suffix is the radio plug only with 5.5" wires and no vehicle side harness on the other end.

COMBINATION DESIRED:

PIONEER **Radio** to GENERAL MOTORS **1988-2005**
JVC **Radio** to NISSAN **1995-UP***
ALPINE **Radio** to TOYOTA **1987-UP***
KENWOOD **Radio** to UNKNOWN VEHICLE

EXAMPLES:

UNIVERSAL = 0001
70-1002 = 1002
70-1398 = 1398
70-1677 = 1677
70-1720 = 1720
70-1743 = 1743
70-1761 = 1761
70-1763 = 1763
70-1770 = 1770

HOW WE DO THE "MATH" & SMART CABLE PART

PR01 + 70-1858 = **PR01-1858**
JV16 + 70-7550 = **JV16-7550**
AL16 + 70-1761 = **AL16-1761**
KN16 + 0001 = **KN16-0001**



AL16-0001

ALPINE
• 16-pin



AL2X8-0001

ALPINE
• 16-pin

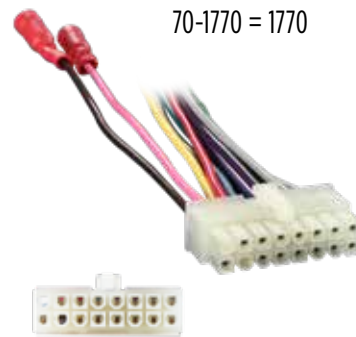

CL16-0001

CLARION
• 16-pin

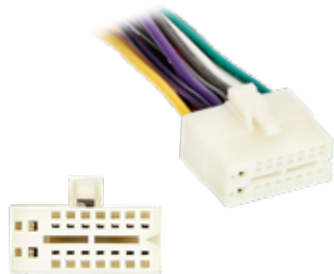

CL2X8-0001

CLARION
• 16-pin



CL2X9-0001

CLARION
• 18-pin



EC2X8-0001

ECLIPSE
• 16-pin

SMART CABLES



JV16-0001

JVC
• 16-pin



JV2X8-0001

JVC
• 16-pin



KN16-0001

KENWOOD
• 16-pin



KN22-0001

KENWOOD
• 22-pin

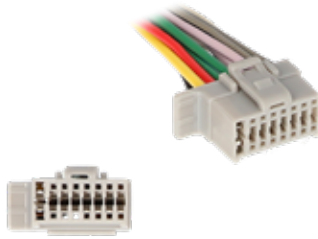

PA01-0001

PANASONIC
• 16-pin

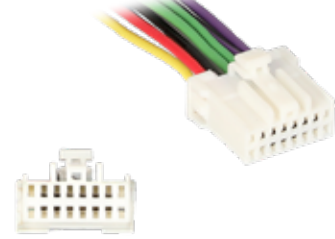

PA16-0001

PANASONIC
• 16-pin



PR01-0001

PIONEER
• 16-pin



PR04-0001

PIONEER
• 16-pin

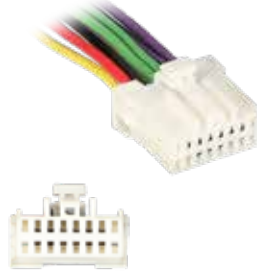

PR16-0001

PIONEER
• 16-pin



PR2000-0001

PIONEER
• 16-pin



PR2X8-0001

PIONEER
• 16-pin



SY16-0001

SONY
• 16-pin



SY18-0001

SONY
• 18-pin



SY2X8-0001

SONY
• 16-pin

INSTALLER *works*

Metra's Installer Works includes all the items that make installations easier while providing the extra polish that sets your work apart from the norm. From speaker adaptor plates to universal ABS blank panels, Installer Works provides top quality for the best installation every time.

INSTALLER *works*

SPEAKER BAFFLES + ADAPTERS



81-4300

UNIVERSAL Speaker Baffles

- Use with 5.25" or 6.5" round speakers
- Seals speaker for better bass response
- Sold as pair



81-6900

UNIVERSAL Speaker Baffles

- Use with 6" x 9" oval speakers
- Seals speaker for better bass response
- Sold as pair



VXT42

UNIVERSAL Speaker Baffles

- Use with 4" round speakers
- Seals speaker for better bass response
- Sold as pair



VXT46

UNIVERSAL Speaker Baffles

- Use with 4" x 6" oval speakers
- Seals speaker for better bass response
- Sold as pair



VXT55

UNIVERSAL Speaker Baffles

- Use with 5" to 5.25" round speakers
- Seals the speaker for better bass response
- Sold as pair



VXT57

UNIVERSAL Speaker Baffles

- Use with 5" x 7" oval speakers
- Seals the speaker for better bass response
- Sold as pair



VXT60

UNIVERSAL Speaker Baffles

- Use with 6.5" round large frame speakers
- Seals the speaker for better bass response
- Sold as pair



VXT62

UNIVERSAL Speaker Baffles

- Use with 6.5" round large frame (shallow depth) speakers
- Seals the speaker for better bass response
- Sold as pair



VXT65

UNIVERSAL Speaker Baffles

- Use with 6.5" round small frame speakers
- Seals the speaker for better bass response
- Sold as pair



VXT69

UNIVERSAL Speaker Baffles

- Use with 6" x 9" oval speakers
- Seals the speaker for better bass response
- Sold as pair

SPEAKER ADAPTERS



82-1011

JEEP Wrangler 1997-2006

- For installation of 4"x 6" aftermarket speakers
- Sold as pair



82-1012

JEEP Wrangler 1997-2006

- For installation of 4" aftermarket speakers
- Sold as pair



82-1013

JEEP Wrangler 1997-2006

- For installation of 5.25" aftermarket speakers
- Sold as pair



82-3002

GM Full-Size Trucks & SUVs 1995-2013

CHEVY Cobalt 2005-2006

Captiva Sport 2012-2015

- Designed for installation of 5.25" to 6.5" aftermarket speakers
- Sold as pair



82-3004

GM Trucks 2014-UP*

- For installation of 6"x 9" aftermarket speakers
- Sold as pair



82-3005

GM Trucks 2014-UP*

- Breakaway tab design allows flexibility for installation of aftermarket 6" to 6.75" speakers
- Sold as pair



82-3006

GM Multi-App* 2005-UP*

- Breakaway tab design allows flexibility for installation of aftermarket 6" to 6.75" speakers
- Sold as pair



82-3010

CHEVROLET Multi-App* 2010-UP*

- Breakaway tab design allows flexibility for installation of aftermarket 6" to 6.75" speakers
- Sold as pair



82-3013

CHEVROLET Corvette 1997-2004

- Breakaway tab design allows flexibility for installation of aftermarket 6" to 6.75" speakers
- Included adapters for smaller speakers
- Sold as pair

SPEAKER ADAPTERS



82-3014

CHEVROLET Corvette 2005-2013 Front Doors

- Breakaway tab design allows flexibility for installation of aftermarket 6" to 6.75" speakers
- Included adapters for smaller speakers
- Sold as pair



82-3015

CHEVROLET Corvette C7 2014-UP*

- Designed for installation of aftermarket tweeters
- Mounts into the factory tweeter locations
- Great for the upgrading to component speaker sets
- Sold as pair



82-3016

GM Multi-App* 2014-UP*

- For installation of aftermarket 2.5" tweeters
- Mounts into the factory tweeter locations
- Great for upgrading to component speaker sets
- Sold as pair



82-3017

GM Camaro | CT6 2016-UP*

- Designed for installation of 6" x 9" aftermarket speakers in the front doors
- Sold as pair



82-3018

GM Camaro | CT6 2016-UP*

- Breakaway tab design allows flexibility for installation of aftermarket 6" to 6.75" speakers
- Sold as pair



82-3019

CHEVROLET Camaro 2010-2015

- Adapters 6" x 9" speaker to rear deck location
- Use Metras 82-6901 to convert to 6" component sets
- Sold as pair



82-3020

CHEVROLET Silverado 2007-2013

GMC Sierra 2007-2013

- Breakaway tab design allows flexibility for installation of aftermarket 6" to 6.75" speakers in the front doors
- Sold as pair



82-3021

GM 2002-2009

- Breakaway tab design allows flexibility for installation of aftermarket 6" to 6.75" speakers
- Sold as pair



82-3022

GM 2002-2009

- Breakaway tab design allows flexibility for installation of aftermarket 6" to 6.75" speakers
- Sold as pair

SPEAKER ADAPTERS



82-3023



GM **2002-2009**

- Designed for installation of tweeters in dash location
- Sold as pair



82-3043

CHEVROLET **S-10** | GMC **Sonoma Truck 1994-2004** CHEVROLET **Blazer** | GMC **Jimmy 1995-2004** | ISUZU **Hombre 1996-2001**

- Designed for installation of 6" to 6.75" speakers in the factory front and rear doors
- Included adapters for smaller speakers
- One pair of adapters in each package



82-3048

CHEVROLET **Express** | GMC **Savana 1996-2007**

- Designed for installation of 5.25" to 6.5" aftermarket speakers
- Sold as pair



82-3300

CHEVROLET **Cavalier** | PONTIAC **Sunfire 1995-2004**

- Designed for installation of 5.25" to 6.5" aftermarket speakers
- Sold as pair



82-3307

CHEVROLET **Equinox** | GMC **Terrain 2005-UP*** PONTIAC **Torrent 2006-2009** SATURN **Vue 2002-2009**

- Breakaway tab design allows flexibility for installation of aftermarket 6" to 6.75" speakers
- Included adapters for smaller speakers
- Sold as pair



82-3412



GEO **Prism 1998-2007**

- Designed for installation of 6" aftermarket speakers
- Sold as pair



82-4201

TOYOTA | CHRYSLER **Multi-App***

- Designed for installation of aftermarket tweeters
- Mount into the factory tweeter locations
- Sold as pair



82-4202

UNIVERSAL **Speaker Adapter**

- Universal speaker mounting adapter for a variety of applications
- Breakaway tab design allows flexibility for installation of aftermarket 6" to 6.75" speakers
- Sold as pair



82-4203

UNIVERSAL **Speaker Adapter**

- Universal speaker mounting adapter for a variety of applications
- Breakaway tab design allows flexibility for installation of aftermarket 6" to 6.75" speakers
- Sold as pair

SPEAKER ADAPTERS



82-4300

UNIVERSAL 1" Plastic Spacer Rings

- Gives 1" extra depth
- Works with most 5.25", 6" or 6.5" speakers
- Sold as pair



82-4301

UNIVERSAL 1" Plastic Spacer Rings

- 1" spacer with breakaway tab design allows flexibility for installation of aftermarket 6" to 6.75" speakers including component drivers
- Sold as pair



82-4400

UNIVERSAL 0.5" Plastic Spacer Rings

- 0.5" spacer designed for installation of 6" to 6.5" aftermarket speakers
- Works with most 5.25" speakers
- Sold as pair



82-4401

UNIVERSAL 0.5" Plastic Spacer Rings

- 0.5" spacer with breakaway tab design allows flexibility for installation of aftermarket 6" to 6.75" speakers including component drivers
- Sold as pair

Three rings on a flat plate for endless options



82-4600

UNIVERSAL 6.5" Speaker Adapter Plate

- Unique four piece design allows for a variety of angles and depth choices
- Universal layout makes it easy to mount the most common and preferred speaker size in almost any sub-panel location
- Sold as pair



82-4601

UNIVERSAL 4"x 10" Speaker Adapter Plate

- Adapts a 4"x 6" speaker to a 4"x 10" location
- Sold as pair



82-4602

UNIVERSAL 4"x 6" Speaker Adapter Plate

- Adapts a 3" speaker to fit a 4"x 6" location
- Sold in pairs



82-5600

FORD | MERCURY | MAZDA 1991-UP*

6"x 8" Speaker Adapter Plate

- Adapts a 5.25" or 6.5" speaker to a 6"x 8" opening
- Sold as pair

Metra

THE INSTALLER'S CHOICE

Our Corporate Mission

To enthusiastically and aggressively approach any opportunity to utilize our braintrusts, facilities, strategies, alliances and capital for the advancement of our employees and stakeholders.

There will be no limitations as we strive to create, innovate, manufacture and deliver high quality, good value products to not only satisfy but also astonish our customers.

By following our vision and attaining high levels of honesty and integrity, we will experience the joy of competition and winning.

SPEAKER ADAPTERS



82-5601

FORD | MERCURY | MAZDA **1991-UP***

5" x 7" Speaker Adapter Plate

- Designed for the installation of a 5.25" speaker and a separate 0.75" to 2" tweeter in a 5" x 7" speaker location
- Sold as pair



82-5602

FORD Explorer **2011-2019**

- Designed for installation of 6X9" aftermarket speakers in the front door
- Sold as pair



82-5603

FORD Explorer **2011-2019**

- Breakaway tab design allows flexibility for installation of aftermarket 6" to 6.75" speakers
- Sold as pair



82-5604

FORD Transit Connect **2014-UP* Front Doors**

(May be used on rear doors and sides if equipped with factory speakers)

- Breakaway tab design allows flexibility for installation of aftermarket 6" to 6.75" speakers
- Includes adapters for smaller speakers
- Sold as pair



82-5605

FORD Multi-App* **2011-UP***

- Breakaway tab design allows flexibility for installation of aftermarket 6" to 6.75" speakers
- Sold as pair



82-5606

FORD F-150 **2015-UP* Front Doors**

- Designed for installation of 6" x 9" size speakers in the factory front doors
- Sold as pair



82-5607

FORD F-150 **2015-UP* Front Doors**

- Breakaway tab design allows flexibility for installation of aftermarket 6" to 6.75" speakers front doors
- Sold as pair



82-5608

FORD Transit **2015-UP***

- Rear speaker adapter
- Breakaway tab design allows flexibility for installation of aftermarket 6" to 6.75" speakers
- Sold as pair



82-6544

FIAT 500 **2017-UP***

- Breakaway tab design allows flexibility for installation of aftermarket 6" to 6.75" speakers in the front doors
- Sold as pair

SPEAKER ADAPTERS



82-6600

CHRYSLER Multi-App* 1995-2010

- Designed for the installation of 5.25" or 6.5" aftermarket speaker to front door
- Sold as pair



82-6601

CHRYSLER Multi-App* 1995-2011

- Breakaway tab design allows flexibility for installation of aftermarket 6" to 6.75" speakers
- Advancement to our existing 82-6600 adapter
- Sold as pair



82-6602

DODGE Dakota | Durango 1997-2004

- Breakaway tab design allows flexibility for installation of aftermarket 6" to 6.75" speakers
- 1" thick to provide more depth for installations
- Sold as pair



82-6603

RAM Promaster City 2015-UP*

- Designed to allow installation of aftermarket 5.25" speakers
- Adapter plate mounting hardware included
 - (8)x # 10 screws
- Speaker mounting hardware included
 - (8)x #8 screws and speed clips
- Sold as pair



82-6900

UNIVERSAL 6"x 9" Speaker Spacer

- Gives 1.5" extra depth
- Use with 6"x 9" speaker
- Sold as pair



82-6901

UNIVERSAL 6"x 9" Speaker Adapter Plate

- Designed for installation of a 5.25" or 6.5" speaker with a separate 0.75" to 2" tweeter in a 6"x 9" speaker location
- Use with any Metra 6"x 9" adapter for 6.5" mounting options
- Sold as pair



82-6902

UNIVERSAL 6"x 9" - 0.5" Speaker Spacer

- Stackable 0.5" spacer for aftermarket 6"x 9" speakers to provide depth where needed
- One piece molded ABS plastic utilizing factory mounting locations for a secure fit
- Sold as pair



82-7000

MITSUBISHI Lancer 2008-2017 | Lancer Sport 2010-2014 | Mirage 2014-2015 | Outlander 2007-2019

- Breakaway tab design allows flexibility for installation of aftermarket 6" to 6.75" speakers
- Sold as pair



82-7300

HYUNDAI | KIA Multi-App* 2010-2014 HYUNDAI Azera Front and Rear 2011-2012 HYUNDAI Sonata Front and Rear 2011-2014 KIA Optima Front and Rear 2010-2012

- Breakaway tab design allows flexibility for installation of aftermarket 6" to 6.75" speakers
- Sold as pair

SPEAKER ADAPTERS



82-7301

HYUNDAI **Genesis Coupe** 2013-2016

- Designed for installation of 6" to 6.75" aftermarket speakers
- Sold as pair



82-7302

HYUNDAI | KIA 2001-2013
 HYUNDAI **I30 Front and Rear** 2012-2013
Tucson Front and Rear 2010-2013
Amanti Front and Rear 2004-2009
Forte Front and Rear 2009-2013
Rondo Front and Rear 2006-2011
Sedona Front 2006-2012
Soul Front and Rear 2009-2012
Optima Front and Rear 2001-2009

- Breakaway tab design allows flexibility for installation of aftermarket 6" to 6.75" speakers
- Sold as pair



82-7303

KIA **Multi-App*** 2014-UP*

- Breakaway tab design allows flexibility for installation of aftermarket 6" to 6.75" speakers in front doors
- Sold as pair



82-7400

NISSAN | INFINITI **Multi-App*** 2000-UP*

- Use in front and rear locations of most all Nissan and Infiniti vehicles
- Breakaway tab design allows flexibility for installation of aftermarket 6" to 6.75" speakers
- Sold as pair



82-7401

INFINITI **G37** 2008-2013

- Breakaway tab design allows flexibility for installation of aftermarket 6" to 6.75" speakers in the front door subwoofer location
- Sold as pair



82-7402

NISSAN **TITAN** 2016-UP*

- Designed to allow aftermarket 6"x 9" speakers
- Sold as pair



82-7500

MAZDA | FORD | NISSAN

- Designed for installation of a 5.25", 6" or a 6.5" aftermarket speaker to an oversized OEM 6.5" opening
- Sold as pair



82-7501

MAZDA **Multi-App*** 2013-UP* **Front Door**

- Breakaway tab design allows flexibility for installation of aftermarket 6" to 6.75" speakers
- Sold as pair



82-7803

HONDA **Accord** 1998-UP* | **Civic** 2001-2005
VW Jetta 1998-2005

- Designed for installation of 5.25" and 6.5" aftermarket speakers
- Sold as pair

SPEAKER ADAPTERS



82-7805

HONDA | ACURA **Multi-App* 2006-UP***

- Breakaway tab design allows flexibility for installation of aftermarket 6" to 6.75" speakers
- Sold as pair



82-8139



TOYOTA **1993-1998**

- Designed for installation of 5.25" to 6.5" aftermarket speakers
- Sold as pair



82-8140



TOYOTA **1993-1998**

- Designed for installation 6" aftermarket speakers
- Sold as pair



82-8146

TOYOTA **Multi-App* 2002-UP***

- Vehicle specific spacer designed for installation of 6"x 9" aftermarket speakers
- One pair of adapters included in each package



82-8147

TOYOTA **Multi-App* 2002-UP***

- Breakaway tab design allows flexibility for installation of aftermarket 6" to 6.75" speakers
- Sold as pair



82-8148

TOYOTA | LEXUS | SCION **Multi-App* 1998-UP***

- Breakaway tab design allows flexibility for installation of aftermarket 6" to 6.75" speakers
- Sold as pair



82-8149

TOYOTA **Camry 2012-2014**

- Designed for installation of 6"x 9" aftermarket speakers
- Sold as pair



82-8150

TOYOTA **Camry 2012-2014**

- Breakaway tab design allows flexibility for installation of aftermarket 6" to 6.75" speakers
- Sold as pair



82-8151

LEXUS **RX300 1999-2003**

- Breakaway tab design allows for installation of aftermarket 6" to 6.75" speakers in the front doors
- Sold as pair

SPEAKER ADAPTERS



82-8152

TOYOTA Multi-App* 2002-2018

- Designed for installation of 6"x 9" aftermarket speakers
- Sold as pair



82-8153

TOYOTA Sequoia 2001-2007

Tundra (double cab) 2004-2006

- Breakaway tab design allows flexibility for installation of aftermarket 6" to 6.75" speakers
- Front door location
- Sold as pair



82-8154

TOYOTA Avalon Rear 2013-2017

TOYOTA Camry Rear 2012-2017

TOYOTA Corolla Rear 2014-2017

- Designed for installation of 6"x 9" aftermarket speakers to the rear deck location
- Use along with 82-6901 for mounting 6" speakers
- Sold as pair



82-8700

FREIGHTLINER Sprinter | MERCEDES Sprinter 2014-2018 Front Doors

- Designed for installation of 5.25" aftermarket speaker in the front doors
- Sold as pair



82-8701

MERCEDES-BENZ C-Class 2007-2017

- Breakaway tab design allows flexibility for installation of aftermarket 6" to 6.75" speakers in the front doors
- Sold as pair



82-8702

MERCEDES-BENZ C-Class 2000-2011

- Breakaway tab design allows flexibility for installation of aftermarket 6" to 6.75" speakers in the front doors
- Sold as pair



82-8703

MERCEDES-BENZ C-Class 2000-2011

- Designed for installation of 5.25" aftermarket speakers in the rear doors
- Sold as pair



82-8704

MERCEDES-BENZ E-Class 1995-2004

- Designed for installation of 6.5" to 6.75" aftermarket speakers in the rear deck location
- Sold as pair



82-8900

SUBARU Legacy 2005-2009

- Breakaway tab design allows flexibility for installation of aftermarket 6" to 6.75" speakers in the rear deck location
- Sold as pair

SPEAKER ADAPTERS



82-8901

SUBARU WRX 2016-UP*

- Breakaway tab design allows flexibility for installation of aftermarket 6" to 6.75" speakers in the rear deck location
- Sold as pair



82-9010

VOLKSWAGEN 2018-UP*

- Breakaway tab design allows flexibility for installation of aftermarket 6" to 6.75" speakers in the rear deck location
- Sold as pair



82-9101

AUDI A3 | A4 2000-2010

- Breakaway tab design allows flexibility for installation of aftermarket 6" to 6.75" speakers in the rear doors
- Sold as pair



82-9102

AUDI A3 | A4 1996-2001

- Breakaway tab design allows flexibility for installation of aftermarket 6" to 6.75" speakers in the rear doors
- Sold as pair



82-9200

VOLVO Multi-App* 2004.5-2018

- Breakaway tab design allows flexibility for installation of aftermarket 6" to 6.75" speakers
- Sold as pair



82-9302

BMW 2002-2008

- Designed for installation of 6" aftermarket speakers
- Sold as pair



82-9303

BMW 3 Series 1999-2010

- Designed for installation of 5.25" aftermarket speakers
- Sold as pair



82-9600

HARLEY-DAVIDSON Touring Models 1998-2013

- Designed for installation of 6" to 6.5" aftermarket speakers
- Sold as pair



82-9601

HARLEY-DAVIDSON Touring Models 1998-2013

- Designed for installation of 6" to 6.5" aftermarket speakers
- Sold as pair

COMBO SPEAKER KITS



82-CH1

CHRYSLER Combo Speaker Kit 1995-2006

- ABS speaker adapter plates (pair)
- Speaker adapter harnesses (pair)
- One convenient package to assist in replacing a pair of speakers



82-CH2

CHRYSLER Combo Speaker Kit 2002-2020

- ABS speaker adapter plates (pair)
- Speaker adapter harnesses (pair)
- One convenient package to assist in replacing a pair of speakers



82-FD1

FORD Combo Speaker Kit 2011-2020

- ABS speaker adapter plates (pair)
- Speaker adapter harnesses (pair)
- One convenient package to assist in replacing a pair of speakers



82-GM1

GM Combo Speaker Kit 1995-2014

- ABS speaker adapter plates (pair)
- Speaker adapter harnesses (pair)
- One convenient package to assist in replacing a pair of speakers



82-GM2

GM Combo Speaker Kit 2014-2020

- ABS speaker adapter plates (pair)
- Speaker adapter harnesses (pair)
- One convenient package to assist in replacing a pair of speakers



82-GM3

GM Combo Speaker Kit 2007-2014

- ABS speaker adapter plates (pair)
- Speaker adapter harnesses (pair)
- One convenient package to assist in replacing a pair of speakers



82-GM4

GM Combo Speaker Kit 2014-2020

- ABS speaker adapter plates (pair)
- Speaker adapter harnesses (pair)
- One convenient package to assist in replacing a pair of speakers



82-HD1

HONDA Combo Speaker Kit 1997-2007

- ABS speaker adapter plates (pair)
- Speaker adapter harnesses (pair)
- One convenient package to assist in replacing a pair of speakers



82-HD2

HONDA Combo Speaker Kit 2006-2020

- ABS speaker adapter plates (pair)
- Speaker adapter harnesses (pair)
- One convenient package to assist in replacing a pair of speakers

COMBO SPEAKER KITS



82-JP1

JEEP Combo Speaker Kit 1997-2006

- ABS speaker adapter plates (pair)
- Speaker adapter harnesses (pair)
- One convenient package to assist in replacing a pair of speakers



82-SU1

SUBARU/TOYOTA Combo Speaker Kit 2003-2020

- ABS speaker adapter plates (pair)
- Speaker adapter harnesses (pair)
- One convenient package to assist in replacing a pair of speakers



82-TY1

TOYOTA Combo Speaker Kit 2013-2020

- ABS speaker adapter plates (pair)
- Speaker adapter harnesses (pair)
- One convenient package to assist in replacing a pair of speakers



82-VW1

VOLKSWAGEN Combo Speaker Kit 1998-2015

- ABS speaker adapter plates (pair)
- Speaker adapter harnesses (pair)
- One convenient package to assist in replacing a pair of speakers

GRILLES



85-HDW1

WOOFER GRILLE MOUNTING KIT

- Includes 85-HDW2 clip pack and (4) screws



85-HDW2

WOOFER GRILLE PLASTIC CLIPS

- Mounting clips only, no hardware included

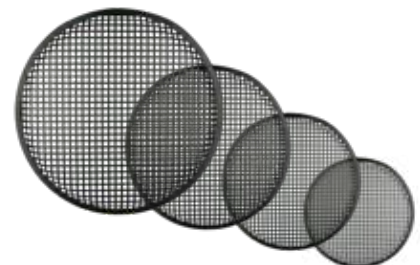

85-9008/9010/9012/9015

UNIVERSAL Steel Woofer Grilles

- Steel
- Available in 8", 10", 12" or 15" diameter
- Hardware sold separately
- Woofer grilles sold individually

TRIM RINGS+ABS



89-30-0125

UNIVERSAL **Plastic DIN Trim Ring**
• 0.125" border



89-30-0250

UNIVERSAL **Plastic DIN Trim Ring**
• 0.25" border



89-30-0500

UNIVERSAL **Plastic DIN Trim Ring**
• 0.5" border



89-30-0750

UNIVERSAL **Plastic DIN Trim Ring**
• 0.75" border



89-30-3900

UNIVERSAL **DIN Spacer**
• 0.3750" thick



89-30-0900

UNIVERSAL **Plastic DIN Trim Rings**
• 4-pack (1 each) INCLUDES: 89-30-0125, 89-30-0250, 89-30-0500, 89-30-0750



89-40-0500

ISO **DIN Trim Ring**
• 0.5" border
• Scored on back for easy modification
• Radio opening: 6.75" x 1.875"

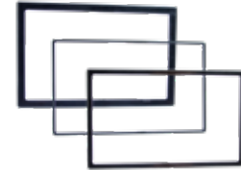

89-50-0900

TRIM RINGS **Universal**
• Universal Double-DIN trim rings for Double-DIN radio installations
• Includes one of three different sizes: .125", .250" and .375"
• Trim rings all have interior opening of 3.95" x 6.825".

ABS



89-00-9025

8" x 12" UNIVERSAL ABS
Blank Panel



89-00-9030

12" x 12" UNIVERSAL ABS
Blank Gridplate
• Waffle board is scored on back for custom installation designs.
• Speaker adapter templates already scored for: tweeters, 3", 4", 5", 5.25", 6.5" and 6" x 9" speakers

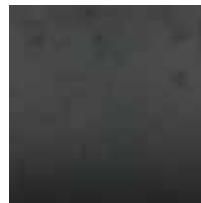

89-00-9031

12" x 12" UNIVERSAL ABS
Blank Panel
• Not packaged



89-00-9032

17" x 21" UNIVERSAL ABS

ANTENNA *works*®

Because you're an installer, you know there's much more to an antenna than the mast. Metra's AntennaWorks aftermarket antennas are designed and engineered as a complete system that functions seamlessly in every application and every weather condition.

ANTENNA *works*®

POWER ANTENNAS & POWER REPLACEMENT MASTS



44-PW20

- Fully automatic with (5) 1" (25mm) custom bases
- 31" (79cm) 4-section replaceable mast
- 55" (140cm) detachable cable
- Needs 11.5" (29cm) under fender
- Custom mounting bases - see Application Chart
- 44-PWEC157 - Power antenna 157" (399cm) extension cable and wiring



BLACK TIP



CHROME TIP



44-PW22 CHROME 44-PW22B BLACK

- Fully automatic 6/BX
- Fully automatic with (6) 1" (25mm) custom bases
- 31" (79cm) 5-section replaceable mast
- 55" (140cm) detachable cable
- Needs 11.5" (29cm) under fender
- 44-PWEC157 - Power antenna 157" (399cm) extension cable and wiring



44-PW530

- Fully automatic with (5) 1" (25mm) custom mounting bases and (1) 3/4" (19mm) adjustable 0-25° mounting base
- 39" (99cm) 4-section replaceable mast
- 55" (140cm) detachable cable
- Needs 13" (33cm) under fender
- 44-PWEC157 - Power antenna 157" (399cm) extension cable and wiring

REPLACEMENT MAST



44-PWR22

- MASTS FOR **44-PW22** | **44-PW22B**
- Stainless steel replacement mast



44-PWR22B

- Black anodized stainless steel replacement mast
- Upgraded option includes black mast and nut



44-PWR64

- MAST FOR **44-PW64** | **44-PW530**
- Stainless steel replacement mast



44-PWEC157

- Power antenna 157" (399cm) extension cable and wiring
- Will fit Metra power antennas and Harada MX22

ADAPTERS

CHRYSLER+FORD+GM



40-CR10

CHRYSLER | DODGE | FORD | GM | JEEP 2002-UP*

Antenna Adapter

- Factory antenna with snap-lock to aftermarket radio



40-CR20

CHRYSLER | DODGE | FORD | GM | JEEP 2002-UP*

Antenna Adapter

- Factory radio with snap-lock to aftermarket antenna



40-CR30

CHRYSLER | FORD | GM 2002-UP*

Antenna Adapter Kit

- Antenna adapters with snap-lock for use with FM modulators

FORD



40-FD10

FORD | LINCOLN | MERCURY 1995-2007

Antenna Adapter

- Factory antenna to aftermarket radio
- OEM style



40-FD20

FORD | LINCOLN | MERCURY 1995-2007

Antenna Adapter

- Factory radio to aftermarket antenna
- OEM style



40-FD30

FORD | LINCOLN | MERCURY 1995-2007

Antenna Adapter

- Antenna adapters for use with FM modulators

GM



40-GM10

GENERAL MOTORS 1988-2013

Antenna Adapter

- Factory antenna with mini "barbed" or "barbless" plug to aftermarket radio



40-GM20

GENERAL MOTORS 1988-2013

Antenna Adapter

- Factory radio with mini "barbed" connector to aftermarket antenna



40-GM30

GENERAL MOTORS 1988-2013

Antenna Adapter

- GM "barbed" antenna adapters for use with FM modulators

ADAPTERS GM+HONDA



40-GM12

GENERAL MOTORS 1988-2013

Antenna Adapter

- Factory antenna with mini “barbed” or “barbless” plug to aftermarket radio



40-GM21

GENERAL MOTORS 1988-2013

Antenna Adapter

- Factory radio with “barbless” connector to aftermarket antenna



40-GM31

GENERAL MOTORS 1988-2013

Antenna Adapter

- GM “barbless” antenna adapters for use with FM modulators

HONDA



40-HD10

HONDA | ACURA 2005-UP* Antenna Adapter

- Factory antenna cable to aftermarket radio



40-HD20

HONDA | ACURA 2005-UP* Antenna Adapter

- Factory radio cable to aftermarket antenna



40-HD30

HONDA | ACURA 2005-UP* Antenna Adapter

- Antenna adapters for use with FM modulators



40-HD10L

MAZDA 2014-UP* Antenna Adapter

- Designed for models with tuner brain
- Length 48”



40-HD21

HONDA | ACURA 2009-UP* Antenna Adapter

- Factory radio cable to aftermarket antenna

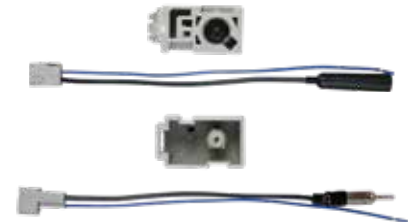

40-HD31

HONDA | ACURA 2009-UP* Antenna Adapter

- Antenna adapters for use with FM modulators



40-HD11

HONDA | ACURA 2009-UP* Antenna Adapter

- Factory antenna cable to aftermarket radio

ADAPTERS

HONDA+HYUNDAI+KIA

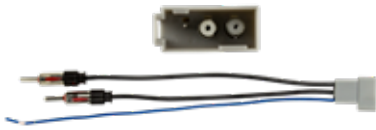

40-HD12

HONDA | ACURA **2009-UP*** Antenna Adapter
 • Factory antenna cable to aftermarket radio



40-HD22

HONDA | ACURA **2009-UP*** Antenna Adapter
 • Factory radio to aftermarket antenna



40-HD32

HONDA | ACURA **2009-UP*** Antenna Adapter
 • Antenna adapters for use with FM modulators



40-HD13

HONDA **2016-UP*** Antenna Adapter
 • Factory antenna cable to aftermarket radio



40-HD23

HONDA **2016-UP*** Antenna Adapter
 • Factory radio to aftermarket antenna

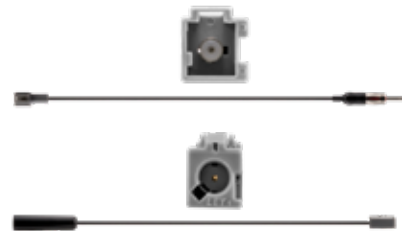

40-HD33

HONDA | ACURA **2016-UP*** Antenna Adapter
 • Antenna adapters for use with FM modulators

KIA+HYUNDAI



40-K110

KIA **2007-UP*** Antenna Adapter
 HYUNDAI **2009-UP*** Antenna Adapter
 • Factory antenna to aftermarket radio



40-K120

KIA **2007-UP*** Antenna Adapter
 HYUNDAI **2009-UP*** Antenna Adapter
 • Factory radio cable to aftermarket antenna

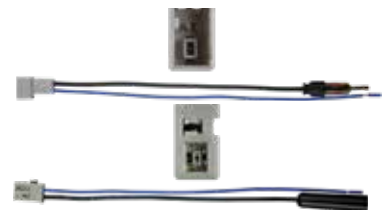

40-K130

KIA **2007-UP*** Antenna Adapter
 HYUNDAI **2009-UP*** Antenna Adapter
 • Antenna adapters for use with FM modulators

ADAPTERS

HYUNDAI+KIA+LEXUS



40-KI11

KIA | HYUNDAI **2009-UP*** Antenna Adapter
 • Factory antenna to aftermarket radio



40-KI21

KIA | HYUNDAI **2009-UP*** Antenna Adapter
 • Factory radio cable to aftermarket antenna



40-KI31

KIA | HYUNDAI **2009-UP*** Antenna Adapter
 • Antenna adapters for use with FM modulators

LEXUS



40-LX10

LEXUS **LS 430 2001-2006** Antenna Adapter
 • Factory antenna cable to aftermarket radio



40-LX20

LEXUS **LS 430 2001-2006** Antenna Adapter
 • Factory radio to aftermarket antenna

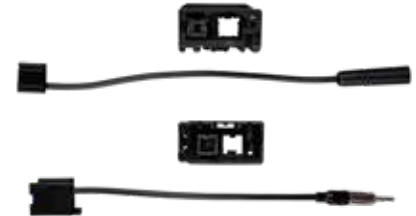

40-LX30

LEXUS **LS 430 2001-2006** Antenna Adapter
 • Antenna adapters for use with FM modulators



40-LX10-204

LEXUS **LS 430 2001-2006** Antenna Adapter
 • Factory antenna cable to aftermarket radio
 • Cable length: 204"



40-LX21

LEXUS | TOYOTA **2006-UP*** Antenna Adapter
 • Factory radio to aftermarket antenna

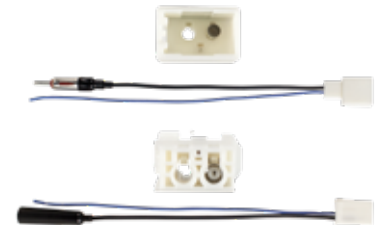

40-LX31

LEXUS | TOYOTA **2006-UP*** Antenna Adapter
 • Antenna adapters for use with FM modulators
 • Includes both a 40-LX11 and 40-LX21



40-LX11

LEXUS | TOYOTA **2006-UP*** Antenna Adapter
 • Factory antenna cable to aftermarket radio

ADAPTERS

INFINITI+NISSAN



40-NI10

INFINITI | NISSAN 1987-2012 Antenna Adapter

- Diversity factory antenna with 2-pin plug to aftermarket radio
- Retains diversity functions



40-NI20

INFINITI | NISSAN 1987-2012 Antenna Adapter

- Diversity factory radio with 2-pin connector to aftermarket antennas
- Retains diversity functions



40-NI30

INFINITI | NISSAN 1987-2012 Antenna Adapter

- Diversity factory antenna with 2-pin plug to aftermarket radio
- Antenna adapters for use with FM modulators



40-NI11

INFINITI | NISSAN 1987-2006 Antenna Adapter

- Diversity factory antenna with 2-pin plug to aftermarket radio
- Disables diversity functions



40-NI21

INFINITI | NISSAN 1987-2006 Antenna Adapter

- Diversity factory radio with 2-pin connector to aftermarket antenna
- Disables diversity functions



40-NI31

INFINITI | NISSAN 1987-2006 Antenna Adapter

- Diversity antenna adapters for use with FM modulators
- Disables diversity functions



40-NI12

INFINITI | NISSAN 2007-UP* Antenna Adapter

- Factory antenna cable to aftermarket radio



40-NI22

INFINITI | NISSAN 2007-UP* Antenna Adapter

- Radio to aftermarket antenna

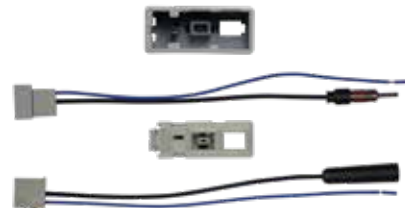

40-NI32

INFINITI | NISSAN 2007-UP* Antenna Adapter

- Adapters for use with FM Modulators

ADAPTERS

SUBARU+EURO STYLE



40-SB10

SUBARU 2005-2013 Antenna Adapter

- Factory antenna cable to aftermarket radio



40-SB10-18

SUBARU Legacy | Outback 2010-2011

- Factory 18" antenna cable adapter



40-SB20

SUBARU 2005-2013 Antenna Adapter

- Factory radio to aftermarket antenna



40-SB30

SUBARU 2005-2013 Antenna Adapter

- Antenna adapters for use with FM modulators



40-SB11

SUBARU 2012-UP* Antenna Adapter

- Factory antenna cable to aftermarket radio



40-SB21

SUBARU 2012-2019 Antenna Adapter

- Factory antenna cable to aftermarket radio



40-SB31

SUBARU 2012-2019 Antenna Adapter for FM Modulators

- Factory antenna cable to aftermarket radio



40-EU10

EUROPEAN 2000-UP* Antenna Adapter

- Factory antenna with mini-style plug to aftermarket radio



40-EU20

EUROPEAN 2000-UP* Antenna Adapter

- Factory radio with mini-style plug to universal antenna



40-EU30

EUROPEAN 2000-UP* Antenna Adapter

- European with mini-style plug antenna adapters for use with FM modulators



40-EU55

GM | CHRYSLER | VW 2002-UP* Antenna Adapter

- Powered version of 40-EU10 with mini-style plug to aftermarket radio



40-EU56

AUDI | BMW | VW 2005-UP* Dual Fakra Antenna Adapter

- Dual mini-style plug version of 40-EU55 to aftermarket radio



40-EU66

AUDI | BMW | VW 2005-UP* Dual Fakra Antenna Adapter

- Factory radio cable to aftermarket antenna
- Can also be used along with the 40-EU56 for "RF adapter" installations

ADAPTERS

VW+AUDI+VOLVO+BMW+MERCEDES-BENZ



40-VL10

VOLVO **1999-2009** Antenna Adpter
• For factory antenna to aftermarket radio



40-VL20

VOLVO **1999-2009** Antenna Adpter
• For factory radio to aftermarket antenna



40-VL30

VOLVO **1999-2009** Antenna Adpter Kit
• Antenna adapters for use with FM modulators



40-VL11

VOLVO **2004-2013** Antenna Connector
• For factory antenna to aftermarket radio



40-VL21

VOLVO **2004-2013** Antenna Connector
• For factory radio to aftermarket antenna



40-VL31

VOLVO **2004-2013** Antenna Connector
• For use with FM modulators



40-VW10

AUDI | BMW | MERCEDES-BENZ | VW **1973-2017**
Antenna Adapter
• Factory antenna with flat plug to aftermarket radio
• Some newer European radios also have capacitors which don't allow this adapter to work properly
- use 40-VW12



40-VW20

AUDI | BMW | MERCEDES-BENZ | VW **1973-2017**
Antenna Adapter
• Factory radio with flat connector to aftermarket antenna



40-VW30

AUDI | BMW | MERCEDES-BENZ | VW **1973-2017**
Antenna Adapter
• For use with FM modulators

AUDI+BMW+MERCEDES-BENZ+VW+UNIVERSAL



40-VW12

AUDI | BMW | MERCEDES-BENZ | VW 1981-2006

Antenna Adapter

- Factory antenna with flat plug to aftermarket radio
- No internal capacitor as that limits proper reception on some European vehicles



40-VW53

AUDI | VW 1998-2010 Antenna Adapter

- Powered version of 40-VW10 to aftermarket radio



40-VW54

AUDI | VW 1998-2010 Antenna Adapter

- Powered version of 40-VW10 to aftermarket radio
- Mini version of 40-VW53 for use in applications with little room



40-VW21

AUDI | BMW | MERCEDES-BENZ | VW 1981-2006

Antenna Adapter

- Factory radio with flat connector to aftermarket antenna
- No internal capacitor as that limits proper reception on some European vehicles

UNIVERSAL



40-UV40

UNIVERSAL Antenna Connectors

- Standard male antenna plug (5/bag)



40-UV41

UNIVERSAL Antenna Adapter

- 10" female to female cable



40-UV42

UNIVERSAL Antenna Adapter

- 10" male to male cable



40-UV43

UNIVERSAL Antenna Adapter

- Male to two female cable
- 20" length



40-UV44

UNIVERSAL Antenna Adapter

- Female to two male cable
- 20" length



40-UV45

UNIVERSAL Antenna Connectors

- Standard female antenna connector (5/bag)

EXTENSION CABLES



44-EC6R | 44-EC12R

RIGHT ANGLE CONNECTOR

44-EC6R

- 6" (15cm) right angle extension cable

44-EC12R

- 12" (30cm) right angle extension cable



44-EC12

EXTENSION CABLES

- 12" (30cm) extension cable



44-EC18

EXTENSION CABLES

- 18" (46cm) extension cable



44-EC24

EXTENSION CABLES

- 24" (61cm) extension cable



44-EC36

EXTENSION CABLES

- 36" (91cm) extension cable



44-EC48

EXTENSION CABLES

- 48" (122cm) extension cable



44-EC72

EXTENSION CABLES

- 72" (182cm) extension cable
- Includes 150pf impedance matching capacitors to prevent signal loss on the 44-EC72 thru 44-EC240



44-EC96

EXTENSION CABLES

- 96" (244cm) extension cable
- Includes 150pf impedance matching capacitors to prevent signal loss on the 44-EC72 thru 44-EC240



44-EC120

EXTENSION CABLES

- 120" (305cm) extension cable
- Includes 150pf impedance matching capacitors to prevent signal loss on the 44-EC72 thru 44-EC240



44-EC144

EXTENSION CABLES

- 144" (366cm) extension cable
- Includes 150pf impedance matching capacitors to prevent signal loss on the 44-EC72 thru 44-EC240



44-EC204

EXTENSION CABLES

- 204" (518cm) extension cable
- Includes 150pf impedance matching capacitors to prevent signal loss on the 44-EC72 thru 44-EC240



44-EC240

EXTENSION CABLES

- 240" (610cm) extension cable
- Includes 150pf impedance matching capacitors to prevent signal loss on the 44-EC72 thru 44-EC240

REPLACEMENT MASTS



44-RM1R

14" UNIVERSAL BLACK RUBBER REPLACEMENT MAST

- Replacement mast for General Motors, Ford, Chrysler and vehicles with Japanese threads
- 14" (36cm) black conductive rubber mast only
- See chart below for the adapters that are included with each mast

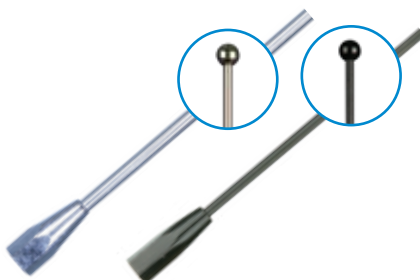

44-RM22 | 44-RM22B

31" UNIVERSAL REPLACEMENT MAST

- Stainless steel or black anodized steel
- Replacement mast for General Motors, Ford, Chrysler and vehicles with Japanese threads
- 31" (79cm) 1-section mast only
- See chart below for the adapters that are included with each mast

Metra
THE INSTALLER'S CHOICE

“

As an installer, you know there's much more to an antenna than just the mast. Metra's AntennaWorks® aftermarket antennas are designed and engineered as a complete system that functions seamlessly in every application and every weather condition.

”



44-RMF2

17" UNIVERSAL BLACK SPIRAL 1-SECTION REPLACEMENT MAST

- Fits factory antenna bases
- (8) adapters included to fit most vehicles
- Includes adapter to groove cut for damaged OEM antenna

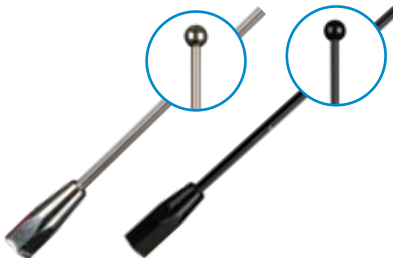

44-SHTS | 44-SHTB

13.5" REPLACEMENT MAST

- Stainless steel or black anodized steel
- Replacement mast for General Motors, Ford, Chrysler and vehicles with Japanese threads
- 13.5" (34cm) 1-section mast only
- See chart to the right for the adapters that are included with each mast

Specifications of adapters included with each mast

(subject to change)

Antenna Base		
Male to Male	6mm to 1/4-28	23.5mm long
Male to Male	6mm to 5/16-18	23.5mm long
Male to Male	6mm to 1/4-20	30mm long
Male to Male	6mm to 10-32	30mm long
Male to Male	6mm to 10-24	30mm long
Male to Female	6mm to 1/4-20	
Male to Female	6mm to M7	



44-RM02 | 44-RM02B

STUBBY REPLACEMENT MAST

- Aluminum or anodized
- For roof mount antenna
- Replaces longer black factory mast
- 3.75" mast
- Includes Male to Male 6mm to 5mm and Male to Male 6mm to 6mm adapters, 23.5mm long



44-RMCF

4" CARBON FIBER ROOF MOUNT REPLACEMENT MAST

- See chart to the right for the adapters that are included with each mast

Specifications of adapters included with each mast above

(subject to change)

Antenna Base		
Male to Male	6mm to 4mm	23.5mm long
Male to Male	6mm to 5mm	23.5mm long
Male to Male	6mm to 6mm	23.5mm long
Male to Male	6mm to 7mm	23.5mm long
Male to Male	6mm to 1/4-20	23.5mm long
Male to Male	6mm to 1/4-28	23.5mm long
Male to Male	6mm to 5/16-18	23.5mm long
Male to Male	6mm to 10-24	23.5mm long
Male to Male	6mm to 10-32	23.5mm long
Male to Male	6mm to 10-24	30mm long
Male to Female	6mm to 1/4-20	
Male to Female	6mm to M7	
Male to Female	6mm to M5	

Metra

REPLACEMENT MASTS



44-STUB

3" BLACK RUBBER REPLACEMENT MAST

- See chart below for the adapters that are included with each mast



44-RMSR

7" RUBBER OEM REPLACEMENT MAST

- See chart below for the adapters that are included with each mast



44-RMWW

8" WIRE WOUND RUBBER OEM REPLACEMENT MAST

- See chart below for the adapters that are included with each mast



44-SHSH

8" BLACK STEEL REPLACEMENT MAST

- See chart below for the adapters that are included with each mast



44-RMCFR3

13" CARBON FIBER WATER TRANSFER PRINT-ROOF OR FENDER

- See chart below for the adapters that are included with each mast

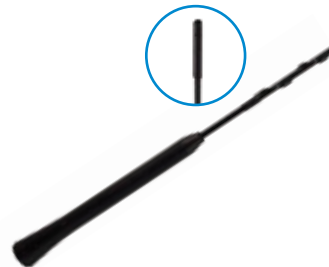

44-RMOE

16" WIRE WOUND FIBERGLASS OEM REPLACEMENT MAST

- See chart below for the adapters that are included with each mast

Specifications of adapters included with each mast above *(subject to change)*

Antenna Base		
Male to Male	6mm to 4mm	23.5mm long
Male to Male	6mm to 5mm	23.5mm long
Male to Male	6mm to 6mm	23.5mm long
Male to Male	6mm to 7mm	23.5mm long
Male to Male	6mm to 1/4-20	23.5mm long
Male to Male	6mm to 1/4-28	23.5mm long
Male to Male	6mm to 5/16-18	23.5mm long
Male to Male	6mm to 10-24	23.5mm long
Male to Male	6mm to 10-32	23.5mm long
Male to Male	6mm to 10-24	30mm long
Male to Female	6mm to 1/4-20	
Male to Female	6mm to M7	
Male to Female	6mm to M5	



44-UA20

ELECTRONIC MAGNETIC ANTENNA

- High-gain amplified antenna for FM bands only
- Active magnetic type antenna working on the magnetic field associated with a conductor excited by a microwave
- Voltage pickup is nanovolts but with the magnetic type circuitry it extracts a signal with superior signal to noise ratio
- Designed for motorcycles or convertibles (not for use under metal)
- 102" coaxial cable and power supply wire
- Gain: FM - 0/6 db | AM - 2/4 db

MASTS & ANTENNAS AMPLIFIED+UNIVERSAL



44-UA25

ON-GLASS MICRO SCREEN FM ANTENNA

- Hide-away, omni-directional antenna with a 54" cable
- Gain: FM - 10/20 db | AM - 0/0 db



44-UA30

AMPLIFIED ROOF MOUNT ANTENNA

- European look amplified roof antenna for AM/FM bands
- 15" (38cm) black helical wind removable fiberglass mast
- 6" (15cm) coaxial cable and power supply wire
- Gain: FM - 10/20 db | AM - 0/0 db



44-UA40

VW AMPLIFIED ROOF MOUNT ANTENNA

- European amplified roof antenna for AM/FM bands
- 15" (38cm) black helical wind removable fiberglass mast
- 6" (15cm) coaxial cable (Power through cable)
- Gain: FM - 10/15 db | AM - 5/10 db



44-UA42

AMPLIFIED ROOF MOUNT ANTENNA

- AM/FM
- Includes 17' coaxial cable and power supply wire - 3/4" hole required
- Gain: FM - 10/15 db | AM - 5/10 db



44-UA44

AMPLIFIED ROOF MOUNT AM/FM ANTENNA

- Includes 17' coaxial cable and power supply wire - 3/4" hole required
- For rear mount installations
- Gain: FM - 10/15 db | AM - 5/10 db
- Also available in white - AW-FIN



44-UA46

AMPLIFIED ROOF MOUNT ANTENNA

- Electronic roof mount AM/FM antenna 3db gain
- 7" (17mm) 1-section detachable black conductive rubber mast
- 195" (15m) signal/power detachable cable
- Requires 9/16" hole
- Gain: FM - 10/15 db | AM - 5/10 db



44-UA60

ANTENNA AMPLIFIER

- Amplifier for FM band only with bypass switch, in-dash or under dash mounting
- 21" (53cm) coaxial cable and power supply wire



44-UA200

AMPLIFIED GLASS MOUNT ANTENNA

- Deluxe high performance windshield or glass mount amplified antenna
- Mount on windshield behind mirror or on fixed side/back windows 14-9/16" (37cm) width
- Gain FM - 10db/12db, AM -5db/2db
- 95" cable



44-UA205

AMPLIFIED GLASS MOUNT SLIM ANTENNA

- AM/FM slim style windshield or glass mount amplified antenna
- Gain FM - 10db/12db, AM -5db/2db
- 11" (28cm) width
- 144" flat cable

ANTENNAS

HARLEY-DAVIDSON+INDIAN+SIRIUS/XM+UNIVERSAL/KEY LOCK



44-RMMC1

HARLEY-DAVIDSON 1998-2013 Replacement Mast

- 19" low profile antenna



44-RMMC2

INDIAN | VICTORY 2012-UP* Replacement Mast

- Strong metal 15" antenna with black rubber cover

SATELLITE RADIO ANTENNAS

The Metra Roof-Mount Satellite Radio Antenna specifically for SiriusXM® Satellite Radio reception have dual-mode functionality, receiving simultaneous signals from satellites and terrestrial repeaters to ensure continuous reception. These are antennas that offer all the benefits of satellite radio and compliment the vehicle's appearance.

FEATURES:

1. Low-profile mounted design, safe for low-clearance conditions, including car washes.
2. Roof mount adhesive acrylic foam pads and necessary mounting hardware and color-coded cable connectors included.
3. Tested and proven to Automotive Environmental Standards, shock-and vibration-proof design.



44-SIXM

SiriusXM® Magnet/Adhesive Mount Antenna

- Low profile mounted design
- Includes 21' cable



40-SIRXM

UNIVERSAL OE Satellite Radio Antenna Adapter

- Adapts the factory satellite antenna connector located at the factory radio location to an aftermarket style connector
- 3' in length



40-SIRXM-17

UNIVERSAL OE Satellite Radio Antenna Adapter

- Adapts the factory satellite antenna connector located at the factory radio tuner-brain location to an aftermarket style connector
- 17' in length

UNIVERSAL/KEY LOCK



44-UL09

KEY LOCK UNIVERSAL Retractable Antenna

- Retractable for 3/4" (19mm) hole
- 31" (79cm) 4-section retractable mast
- 48" (122cm) cable, requires 9.5" (23cm) under fender



44-UL10

UNIVERSAL Retractable Antenna

- Universal locking top mount for 1" (25mm) hole
- 37" (94cm) 4-section retractable mast
- 48" (122cm) cable, requires 9.5" (23cm) under fender



40-GPS-JAK



FACTORY NAVIGATION ANTENNA ADAPTER TO FAKRA CONNECTOR

- For Alpine, JVC, Kenwood, and aftermarket navigation radios
- 6" in length

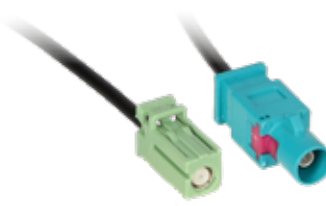

40-GPS-PIO



FACTORY NAVIGATION ANTENNA ADAPTER TO FAKRA CONNECTOR

- For Pioneer aftermarket radios
- 6" in length



44-UL15

UNIVERSAL Retractable Antenna

- Locking top mount with key for 3/4" (19mm) hole
- 37" (94cm) 4-section retractable mast
- 48" (122cm) cable, requires 9.5" (23cm) under fender



44-UM53

UNIVERSAL Mirror Mount Antenna

- Mirror mount for heavy-duty applications
- 31" (79cm) 1-section removable mast with spring
- 120" (305cm) cable



44-UP21

TOYOTA | UNIVERSAL Pillar Mount Antenna

- Toyota and Universal pillar mount applications
- 50" (127cm) 3-section retractable mast
- 48" (122cm) cable



44-UP58

UNIVERSAL Pillar Mount Antenna

- Offset left/right hand pillar mount
- 50" (127cm) 3-section retractable mast
- 65" (165cm) cable



44-US01R

UNIVERSAL Rubber Antenna

- Side/top mount for (4) hole application
- Split ball heavy-duty round, black base
- 14" (36cm) removable black conductive rubber mast
- 96" (244cm) detachable special low capacitance cable



44-US03R

UNIVERSAL Rubber Antenna

- Side/top mount for 1" (25mm) hole split ball
- 14" (36cm) removable black conductive rubber mast
- 54" (137cm) cable



44-US07R

UNIVERSAL Rubber Antenna

- Side/top mount for 1" (25mm) hole split ball
- 14" (36cm) removable black conductive rubber mast
- 54" (137cm) cable



44-MAUS07R

UNIVERSAL White Rubber Antenna

- Side/top mount for 1" (25mm) hole split ball
- 14" (36cm) removable white conductive rubber mast
- 54" (137cm) cable



44-US13

UNIVERSAL Antenna

- Side/top mount for 1" (25mm) hole split ball
- 53" (135cm) 3-section mast with spring
- 54" (137cm) cable

ANTENNAS UNIVERSAL



44-US19

UNIVERSAL Antenna

- Top/side mount for 1" (25mm) hole split ball
- Adjustable angle to 180°
- 45" (114cm) 3-section mast
- 54" (137cm) cable



44-US30

UNIVERSAL Antenna

- Side/top mount for 1" (25mm) hole split ball
- 31" (79cm) 1-section mast with spring
- 54" (137cm) cable



44-US71

UNIVERSAL Antenna

- Side/top mount for 1" (25mm) hole split ball
- 31" (79cm) 1-section mast with spring
- 54" (137cm) cable



44-UT03R

UNIVERSAL Rubber Antenna

- Top mount for 1" (25mm) hole, split ball
- 14" (36cm) removable black conductive rubber mast
- 54" (137cm) cable



44-UT10

UNIVERSAL Antenna

- Top mount for 1" (25mm) hole
- 38" (97cm) 3-section removable mast
- 48" (122cm) cable



44-UT30

UNIVERSAL Antenna

- Top mount for 1" (25mm) hole
- 31" (79cm) 1-section removable mast
- 50" (127cm) cable



44-UT91

UNIVERSAL Narrow Base Antenna

- Top mount for 3/4" (19mm) hole
- Narrow fender applications
- 31" (79cm) removable mast with 72" (183cm) cable



44-ANT10

UNIVERSAL Dipole Hide-Away Antenna

- Flexible wire antenna
- 48" (122cm) cable
- Easy to hide



44-ANT90M

UNIVERSAL Marine Style Antenna

- Flexible antenna
- 48" (122cm) cable
- Right angle motorola style connector
- Water-resistant
- Easy to hide



44-US51B

JEEP CJ-7 1979-1986 Wrangler 1985-1996

- Side mount for universal (4) hole application
- 31" (79cm) 1-section removable black mast
- 60" (152cm) detachable cable



44-US401

JEEP CJ-7 1974-1978

- Side mount for universal (2) hole applications
- 31" (79cm) 3-section removable mast with spring
- 60" (152cm) detachable cable



44-US502

JEEP CJ-7 1979-1986 Wrangler 1985-1996

- Side mount for (4) hole applications
- 39" (96cm) 3-section removable mast
- 60" (152cm) detachable cable



44-CR72

JEEP Comanche | Cherokee | Wagoneer 1985-1996

- 31" (79cm) removable mast
- 80" (203cm) cable



44-CR88

CHRYSLER Multi-Application

- Universal multi-application antenna
- 31" (79cm) removable mast
- 61" (155cm) cable



44-CR190B

DODGE Ram Truck 1994-2012

- Side mount for (4) hole applications
- 39" (96cm) 3-section removable mast
- 60" (152cm) detachable cable



44-FD80

FORD Universal Rectangular Base 1965-1997

- 31" (79cm) removable mast with 72" (183cm) cable



44-FD810

FORD | LINCOLN | MAZDA | MERCURY 1965-1997

- Universal antenna with (2) base options
- 31" (79cm) removable mast with 72" (183cm) cable

ANTENNAS

BMW + CHEVROLET + GM + HONDA + TOYOTA



44-GM92

CHEVROLET | GMC Full Size Truck 1500
2500 | 3500 1988–2002

- 31" (79cm) removable mast
- 72" (183cm) cable



44-GM92B

CHEVROLET | GMC Full Size Truck 1500
2500 | 3500 1988–2002

- 31" (79cm) removable black mast
- 72" (183cm) cable



44-GM935

GENERAL MOTORS Multi-Applications
1982–UP*

- Universal with 5 fixed-angle bases
- 31" (79cm) 1-section removable mast with 72" (183cm) cable



44-GM935B

GENERAL MOTORS Multi-Applications
1982–UP*

- Universal with 5 fixed-angle bases
- 31" (79cm) 1-section removable black mast with 72" (183cm) cable



44-GM94B

GENERAL MOTORS Trucks and Vans

- 31" (79cm) black removable mast with 61" (165cm) cable



44-HD98

HONDA Civic 1992–UP*

GEO Prizm 1993–UP Storm 1990–1993

TOYOTA Corolla SR5 (RWD) 1988–1991

ISUZU Stylus 1990–1991

- 37" (94cm) 2-section retractable mast with 80" (200cm) cable



44-UL105

BMW | MERCEDES-BENZ | JAGUAR
PEUGEOT | PORSCHE

- 37" (94cm) 5-section chrome retractable mast
- 48" (122cm) cable, requires 9.5" (23cm) under fender
- 2 mounting heads for 3/4" hole or 1" hole



44-TY23

TOYOTA Truck 4Runner 1989–1995

Camry 1983–1986 | Celica Supra 1983–1985

- 31" (79cm) removable mast with 59" (150cm) cable



44-TY205

GEO Prizm 1990–1992 | SUBARU Impreza 1993–1995

Loyale 1990–1994 | TOYOTA Camry | Corolla 1984–UP

GTS | FX16 1987–1990

Paseo 1992–UP | Tercel 1987–UP

- 31" (79cm) 1-section retractable mast with 88" (224cm) cable

AMMO STYLE VEHICLE ANTENNAS

.30 Caliber Antennas



- Designed for AM/FM radio bands
- Easy installation
- Fits most factory antenna bases
- Multiple adapters included to fit different makes and models
- Designed for vehicles with removable masts
- Replacement antenna
- Threaded mounting
- Billet aluminum
- Non-lethal replica



30GM

GUN METAL

- 4.25" billet aluminum .30 cal replica antenna mast in gun metal



30FB

FLAT BLACK

- 4.25" billet aluminum .30 cal replica antenna mast in flat black



30GCF

GOLD with Carbon Fiber

- 4.25" billet aluminum .30 cal replica antenna mast in gold with carbon fiber wrap



30KN

KRYPTEK® NEPTUNE™ CAMO WRAP

- 4.25" billet aluminum .30 cal replica antenna mast

AMMO STYLE VEHICLE ANTENNAS

.50 Caliber Antennas



- Designed for AM/FM radio bands
- Fits most factory antenna bases
- Multiple adapters included
- Designed for vehicles with removable masts
- Threaded mounting
- Non-lethal replica



50CF

BILLET with Carbon Fiber

- 5.5" billet aluminum .50 cal replica antenna mast with carbon fiber wrap



50US

US FLAG

- 5.5" billet aluminum .50 cal replica antenna mast with U.S. flag wrap



50KN

KRYPTEK NEPTUNE™

- 5.5" billet aluminum .50 cal replica antenna mast with Kryptek Neptune wrap



50CFB

BLACK with Carbon Fiber

- 5.5" billet aluminum .50 cal replica antenna mast with black carbon fiber wrap



50FB

FLAT BLACK

- 5.5" billet aluminum .50 cal replica antenna mast with flat black wrap

AMMO STYLE VEHICLE ANTENNAS

.50 Caliber Antennas



50GD

GOLD

- 5.5" billet aluminum .50 cal replica antenna mast in gold



50GM

GUN METAL

- 5.5" billet aluminum .50 cal replica antenna mast in gun metal



50HC

MOSSY OAK® VREAK-UP COUNTRY®

- 5.5" billet aluminum .50 cal replica antenna mast with Mossy Oak® Break-Up Country™ hydro dip



50WF

WILDFIRE

- 5.5" billet aluminum .50 cal replica antenna mast

ARROW ANTENNA

- Designed for AM/FM radio bands
- Fits most factory antenna bases
- Multiple adapters included
- Designed for vehicles with removable masts
- Threaded mounting
- Fiberglass mast
- Non-lethal replica



ARLNG

MOSSY OAK®

- 20" hunting arrow replica antenna with fiberglass mast and Mossy Oak® Break-Up Country® hydro dip

AMMO STYLE VEHICLE ANTENNAS

AMMOTENNA® Retail



AMMO-DISPLAY

- POP display available
- Vibrant colors to attract customers
- Eye catching packaging shaped like a bullet
- Consistent sizes for easy planogram
- Theft-resistant thermoform clamshell
- Centered product for balance while hanging
- Easy-to-read bold identifiers
- Includes all adapters for roof or fender mounting



Includes All Adapters for Roof or Fender Mounting

Included adapters for most applications:

M6-1.0 TO 5/16TH-18

M6-1.0 TO M7-1.0

M6-1.0 TO M5-0.8

M6-1.0 TO #10-24

M6-1.0 TO 1/4-20

M6-1.0 TO #10-32

M6-1.0 TO 1/4-28

M6-1.0 TO M6-1.0

M6-1.0 TO 10-24 LONG

M6-1.0 TO M4-0.7

M6-1.0 TO 1/4-20 FEMALE ADAPTER

M6-1.0 TO M5-0.8 FEMALE ADAPTER

M6-1.0 TO M7-1.0 FEMALE ADAPTER

M6 TO M6 MALE / FEMALE 50 CAL ONLY

RUBBER WASHER



PRODUCT *Locator*

Metra's EZ-Order Product Locator provides quick, convenient reference to all product locations in this catalog.

PRODUCT *locator*

PRODUCT LOCATOR

PART NUMBER	MAKE	DESCRIPTION	PAGE
TURBO KITS			
86-3528	General Motors	GTO Radio Removal Tool	46
86-5618	Ford	Ford Radio Removal Tool	12
86-9001	VW	Volkswagen/Audi/Mercedes 1998-2006 Radio Removal Tool	119
87-09-4012	General Motors	Metal Basket	47
87-99-3052	General Motors	Chevrolet Truck	41
88-00-2020	General Motors	Buick Regal Cassette Pocket	33
88-00-3301	General Motors	Chevrolet General MotorsC Full Size Truck Pocket	35
88-00-3302	General Motors	General Motors Truck & SUV Replacement Pocket	43
88-00-7422	Nissan	Nissan Maxima/Sentra Turbo Pocket	99
88-00-8000	Toyota	Toyota Pocket	103
88-00-9000	Ford	Ford/Mazda/Nissan/Toyota/Volvo Under Radio Multi-Pocket	129
88-00-9006	Multi-Kit	Toyota/Nissan/Subaru/Mitsubishi	130
88-00-9007	Multi-Kit	Toyota/Nissan/Subaru/Mitsubishi	130
88-00-9008	VW	Volkswagen Pocket	119
89-30-3310	General Motors	Pontiac Sunbird Custom Trimplate	45
89-50-0900	Universal	Universal Trim Rings	129
89-9400	Land Rover	Land Rover Discovery	128
89-99-4002	General Motors	General Motors Component Parts	47
95-1003	Hyundai/Kia	Kia Sephia/Sportage/Rio/Spectra	61
95-1005	Hyundai/Kia	Kia Sedona/Kia Spectra/Rio/Sorrento LX(exc.sport packages)	61
95-1006	Hyundai/Kia	KIA Sorento EX/KIA Sorento LX Sport	61
95-2001	General Motors	GM Multi Kit (oversize GM radio)/Buick/Cadillac/Chevrolet/GMC/Oldsmobile/Pontiac/Isuzu	32
95-2004	Cadillac	Cadillac DeVille (column shift only)/Catera	32
95-2005B	Cadillac	Cadillac Eldorado/Seville /DeVille /DeVille Concours (console shift only)	32
95-2009	General Motors	General Motors Suzuki Multi-Kit	33
95-3000	General Motors	General Motors Trucks and SUVs	34
95-3003G	General Motors	General Motors Truck / SUV	34
95-3004	General Motors	Cadillac Escalade	36
95-3005	Chevrolet/GM	Astro/Safari	36
95-3009	General Motors	Chevrolet Camaro / Pontiac Firebird	36
95-3016G	General Motors	Chevrolet Colorado/General MotorsC Canyon	37
95-3017B	General Motors	Chevrolet Trax	37
95-3019B	General Motors	Chevrolet Malibu	39
95-3020HG	General Motors	Chevrolet Cruze	39
95-3020B	General Motors	Chevrolet Cruze	39
95-3022B	General Motors	Chevrolet Equinox	39
95-3023HG	General Motors	Chevrolet Trax	40
95-3025B	General Motors	Buick Encore / Vauxhall / Opel Mokka	40
95-3027	General Motors	General Motors Small Trucks/SUV's	40
95-3031B	General Motors	Captiva Sport	40
95-3105	General Motors	Saturn (All Models)	42
95-3107G	General Motors	Saturn Astra	42
95-3107S	General Motors	Saturn Astra	42
95-3302	General Motors	Cobalt/Equinox/HHR/Malibu/Pontiac G5/Solstice/Torrent	43
95-3302S	General Motors	Cobalt/Equinox/HHR/Malibu/Pontiac G5/Solstice/Torrent	43
95-3303B	General Motors	Chevrolet Malibu/Chevrolet Cobalt/Pontiac G6	43
95-3304	General Motors	Corvette/Uplander/Pontiac Montana SV6/Saturn Relay/Buick Terazza/Hummer H3	43
95-3305	General Motors	General Motors Multi-Kit	44
95-3306	General Motors/Pontiac	Chevrolet Aveo/Pontiac G3	44
95-3310B	General Motors	Chevrolet Traverse / General MotorsC Acadia / Buick Enclave	45
95-3312G	General Motors	Pontiac Firebird	45
95-3314G	General Motors	Chevrolet Malibu with Manual Climate Controls	45
95-3318B	General Motors	Chevrolet Malibu	45
95-3527	General Motors	Pontiac Grand Prix	46
95-3528G	General Motors	Pontiac GTO	46
95-3528B	General Motors	Pontiac GTO	47
95-5000B	Ford/Lincoln/Mercury	Thunderbird /Lincoln LS	12
95-5000S	Ford/Lincoln/Mercury	Thunderbird /Lincoln LS	12
95-5025	Ford	Mustang	12



PRODUCT LOCATOR

PART NUMBER	MAKE	DESCRIPTION	PAGE
TURBO KITS			
95-5026	Ford/Lincoln/Mercury	Mustang/Explorer/Expedition/Aviator/Navigator/Mountaineer	13
95-5028	Ford	Ford Expedition Navigator w/ factory NAV / Lincoln Navigator w/ factory NAV	13
95-5701	Ford	F-Series Trucks/Bronco/F-250/F-350	14
95-5702	Ford	Aerostar	14
95-5703	Ford	Mustang	14
95-5704	Ford	Econoline	14
95-5806	Mercury	Mercury Cougar/Ford Focus	17
95-5809	Lincoln	Continental	18
95-5810	Ford	Lincoln Town Car	18
95-5812	Ford/Lincoln/Mercury	Ford/Lincoln/Mercury	18
95-5817	Ford/Lincoln/Mercury	Ford/Lincoln/Mercury/Mazda Multi Kit	19
95-5818	Ford/Lincoln	Ford/Lincoln Multi Kit/F-150/Expedition/Navigator/Blackwood	19
95-5819	Ford	Ford F-150 (base model only)	19
95-5820B	Ford	Ford F-150 (excluding base model)	19
95-5820CB	Ford	Ford F-150	19
95-5820DW	Ford	Ford F-150	20
95-5820HG	Ford	Ford F-150 Select Models	20
95-5820SS	Ford	Ford F-150	20
95-5822B	Ford	Ford F-150 (matte black)	21
95-5822MM	Ford	Ford F-150 Lariat (Milano Maple)	21
95-5822CM	Ford	Ford F-150 King Ranch (Curly Maple)	21
95-5822AS	Ford	Ford F-150 Platinum (Ash Satin)	21
95-5844S	Lincoln	Lincoln Navigator (4x2 models)	26
95-5845S	Lincoln	Lincoln Navigator (4x4 models)	26
95-5850B	Ford	F-250 XL models not equipped with CD player	28
95-5853CH	Ford	Ford Mustang	29
95-5860	Ford	E Series Cutaway	30
95-6506B	Chrysler	Chrysler Pacifica	1
95-6511	Chrysler	Chrysler/Dodge/Jeep	2
95-6513B	Chrysler	Jeep Grand Cherokee	2
95-6517HG	Dodge	Dodge Dart without factory 8.4" screen	3
95-6518B	Ram	RAM 1500/2500/3500 without factory 8.4" screen	3
95-6521B	Fiat	Fiat 500L	4
95-6522B	Dodge	Dodge Ram 1500/2500/3500	4
95-6523	Ram	Ram Promaster	5
95-6524B	Jeep	Jeep Liberty	5
95-6528B	Dodge	Dodge Ram 2500/3500 Chassis Cab	6
95-6531HG	Ram	Ram Promaster City	6
95-6532B	Jeep	Jeep Renegade	6
95-6533B	Chrysler/ Dodge/Jeep	Chrysler PT Cruiser/ Dodge Durango/ Jeep Grand Cherokee	6
95-6534B	Dodge/Jeep	Jeep Patriot/ Jeep Compass/ Dodge Caliber (without factory NAV)	6
95-6535B	Fiat	Fiat 500X	6
95-6539B	Dodge/Chrysler	Dodge Caravan/Chrysler Town & Country	7
95-6541	Jeep	Jeep Wrangler	8
95-6542	Dodge	Dodge Durango/Dodge Dakota	8
95-6544B	Fiat	Fiat 500	8
95-6545B	Jeep	Jeep Compass Sport	8
95-6546B	Jeep	Jeep Grand Cherokee	9
95-6547B	Dodge	Dodge Dakota/Durango	9
95-6549	Jeep	Jeep Wrangler	9
95-6551	Dodge	Dodge Ram	10
95-6554B	Jeep	Cherokee	10
95-6555B	Dodge	Ram	11
95-6556DK	Jeep	Commander	11
95-6556G	Jeep	Commander	11
95-6557B	Dodge	Dakota	11
95-7015CHG	Mitsubishi	Mitsubishi Outlander	84
95-7016GHG	Mitsubishi	Mirage without OE NAV/Mirage G4 without OE NAV	85
95-7017B	Mitsubishi	Mitsubishi Lancer	85

PRODUCT LOCATOR

PART NUMBER	MAKE	DESCRIPTION	PAGE
TURBO KITS			
95-7018B	Mitsubishi	Mitsubishi Outlander Sport (Black)	85
95-7018CHG	Mitsubishi	Mitsubishi Outlander Sport (Charcoal High Gloss)	85
95-7019	Mitsubishi	Mirage/Mirage G4	86
95-7020	Mitsubishi	Eclipse Cross ES	86
95-7309	Hyundai/Kia	Hyundai Elantra/ Sonata/ Tiburon/ Santa Fe	62
95-7313	Hyundai/Kia	Hyundai Elantra/ Sonata/ Tiburon / Kia Optima	62
95-7315	Hyundai/Kia	Hyundai Tucson	63
95-7318	Hyundai/Kia	Kia Spectra	63
95-7319	Kia	Kia Amanti	63
95-7320	Hyundai/Kia	Hyundai Sonata	63
95-7321	Hyundai/Kia	Kia Rio/Hyundai Accent	64
95-7322	Hyundai	Hyundai Azera	64
95-7323	Hyundai	Hyundai Entourage KIA Sedona	64
95-7324	Kia	KIA Optima	64
95-7325B	Hyundai	Hyundai Santa Fe	65
95-7326	Hyundai	Hyundai Elantra	65
95-7328	Kia	KIA Sorrento	65
95-7329	Kia	KIA Rondo	65
95-7330	Kia	KIA Spectra	65
95-7331	Kia	KIA Amanti	66
95-7332	Hyundai	Hyundai Elantra (for factory radio delete option)	66
95-7333	Hyundai	Hyundai Sonata	66
95-7336S	Hyundai	Hyundai Genesis Coupe	67
95-7337B	Kia	Kia Soul	67
95-7339B	Hyundai	Hyundai Genesis Coupe	67
95-7339S	Hyundai	Hyundai Genesis Coupe	68
95-7340B	Kia	Kia Sorento	68
95-7344CH	Kia	Kia Sportage	68
95-7344G	Kia	Kia Sportage	69
95-7345B	Kia	Kia Optima	69
95-7349B	Kia	Kia Soul	69
95-7350B	Hyundai	Hyundai Veloster	70
95-7352B	Hyundai	Hyundai Genesis Coupe	70
95-7353CH	Kia	Kia Rio	70
95-7354B	Hyundai	Hyundai Santa Fe	70
95-7355B	Kia	Kia Sorento	70
95-7356B	Kia	Kia Forte	71
95-7357HG	Hyundai	Hyundai Elantra GT	71
95-7359B	Kia	Kia Optima	71
95-7360B	Kia	Kia Soul	71
95-7361S	Hyundai	Hyundai Santa Fe With Factory NAV	72
95-7362B	Hyundai	Hyundai Elantra	72
95-7364B	Hyundai	Hyundai Tucson	72
95-7365B	Hyundai	Kia Sedona	72
95-7366B	Kia	Kia Sorento	73
95-7369B	Hyundai	Hyundai Tucson	73
95-7376B	Hyundai	Hyundai Elantra	74
95-7377B	Kia	Kia Optima	74
95-7378B	Kia	Kia Sportage LX with 5" screen	74
95-7383	Hyundai	Hyundai Sonata	75
95-7391B	Kia	Kia Rio	77
95-7393B	Hyundai	Hyundai Accent	78
95-7398	Hyundai	Venue	78
95-7404S	Nissan	Nissan Maxima	89
95-7405	Nissan	Nissan Titan	89
95-7406	Nissan	Nissan Titan & Armada (without dual zone climate controls)	89
95-7416G	Nissan	Nissan Maxima (Equipped with Bose or Comfort and Convenience packages)	90
95-7417	Nissan	Nissan Multi-Kit	91
95-7418	Nissan	Nissan Altima	91



PRODUCT LOCATOR

PART NUMBER	MAKE	DESCRIPTION	PAGE
TURBO KITS			
95-7419	Nissan	Nissan Altima	91
95-7424	Nissan	Nissan Titan	92
95-7425	Nissan	Nissan Rogue	92
95-7427G	Nissan	Nissan Maxima	92
95-7502B	Mazda	Mazda MPV	79
95-7504	Mazda	Mazda 3	79
95-7510	Mazda	Mazda RX8	80
95-7510HG	Mazda	Mazda RX8	80
95-7521B	Mazda	Mazda 5	82
95-7522B	Mazda	Mazda CX5	82
95-7526B	Mazda	Mazda 3	82
95-7603	Nissan	Nissan Multi	93
95-7605A	Infiniti	Infiniti G35	88
95-7617B	Nissan	Nissan Altima	95
95-7617GHG	Nissan	Nissan Altima	95
95-7618G	Nissan	Nissan Sentra	95
95-7619	Nissan	Nissan Titan / Frontier / Xterra with 4.3" color display	96
95-7621	Nissan	Nissan Versa / Note	96
95-7622HG	Nissan	Nissan Rogue	96
95-7623	Nissan	Nissan NV200	97
95-7624	Nissan	Nissan Multi-Kit	97
95-7628BHG	Nissan	Nissan Murano	97
95-7631B	Nissan	Nissan Titan/Titan XD	98
95-7634B	Nissan	Nissan MP300	98
95-7636B	Nissan	Nissan Kicks	98
95-7637B	Nissan	Nissan Altima	99
95-7638	Nissan	Nissan Sentra	99
95-7639HG	Nissan	Nissan Titan	99
95-7801	Honda	Honda/Acura Multi-Kit	51
95-7802CH	Honda	Honda CRV	51
95-7805CH	Honda	Honda Acura TSX	52
95-7807	Honda	Honda Accord / Crosstour with NAV	52
95-7807T	Honda	Honda Accord / Crosstour with NAV	52
95-7810B	Honda	Honda HRV	53
95-7811B	Honda	Honda Pilot (Black)	53
95-7811HG	Honda	Honda Pilot (High Gloss)	53
95-7812B	Honda	Honda Civic LX	53
95-7815B	Acura	Acura TL	54
95-7817HG	Honda	Honda CRV	54
95-7820B	Acura	Acura MDX	55
95-7861	Honda	Honda Pilot	55
95-7862	Honda	Honda Accord	55
95-7863	Honda	Honda Element	55
95-7866B	Honda	Acura MDX	56
95-7867	Honda	Acura RSX Type-S	56
95-7868B	Honda	Acura CL/TL	56
95-7870G	Honda	Honda Ridgeline	56
95-7870T	Honda	Honda Ridgeline	57
95-7877B	Honda	Honda Fit	58
95-7877S	Honda	Honda Fit	58
95-7879	Honda	Honda Cruze	58
95-7881G	Honda	Honda Civic	59
95-7882B	Honda	Honda Civic	59
95-7883HG	Honda	Honda Fit	59
95-7895	Honda	Honda Accord with pocket	60
95-7899	Honda	Honda Civic (Excludes Si & 2005 SE Models)	61
95-7951	Suzuki	Suzuki Verona & Forenza/ Chevrolet Aveo / Aveo Hatchback	100
95-7953	Suzuki	Suzuki Grand Vitara	100
95-7953T	Suzuki	Suzuki Grand Vitara	100

PRODUCT LOCATOR

PART NUMBER	MAKE	DESCRIPTION	PAGE
TURBO KITS			
95-7955	Suzuki	Suzuki Kizashi	101
95-8150	Lexus	Lexus ES Series	116
95-8152	Lexus	Lexus GS Series	116
95-8153	Lexus	Lexus LS Series	116
95-8154	Lexus	Lexus GS Series	116
95-8155	Lexus	Lexus ES Series	117
95-8156	Lexus	Lexus LS Series	117
95-8157B	Lexus	Lexus SC Series	117
95-8160G	Lexus	Lexus LS430 without factory NAV	117
95-8166G	Lexus	Lexus GX 470	118
95-8202	Toyota	Toyota/Scion Multi-Kit	104
95-8204	Toyota	Toyota Corolla	104
95-8208	Toyota	Toyota Sienna	105
95-8210	Toyota	Toyota 4Runner (Limited Radios)	105
95-8211	Toyota	Toyota Avalon	105
95-8212	Toyota	Toyota Solara	106
95-8214TB	Toyota	Toyota Tacoma	106
95-8214TG	Toyota	Toyota Tacoma	106
95-8215S	Toyota	TOYOTA Avalon	107
95-8217B	Toyota	Toyota RAV4	107
95-8218S	Toyota	Toyota Camry	107
95-8223	Toyota	Toyota Corolla	108
95-8223S	Toyota	Toyota Corolla	108
95-8224	Toyota	Toyota Matrix / Pontiac Vibe	108
95-8225G	Toyota	Toyota Venza	109
95-8226B	Toyota	Toyota Prius / Plug-In/PHV	109
95-8235CHG	Toyota	Toyota Tacoma	110
95-8237S	Toyota	Toyota Matrix	110
95-8239B	Toyota	Toyota Prius C	111
95-8240B	Toyota	Toyota Prius	111
95-8242G	Toyota	Toyota RAV4	111
95-8243B	Toyota	Toyota Prius V	112
95-8244HG	Toyota	Toyota Avalon	112
95-8245CHG	Toyota	Toyota Corolla	112
95-8246HG	Toyota	Toyota Tundra	112
95-8248B	Toyota	Toyota Highlander	112
95-8250	Toyota	Toyota Sienna	113
95-8262HG	Toyota	Toyota Corolla	113
95-8264HG	Toyota	Toyota Prius	114
95-8265HG	Toyota	Toyota C-HR	114
95-8720B	Smart	SMART Fortwo	128
95-8721B	Mercedes	Mercedes C-Class	126
95-8722B	Mercedes	Mercedes C-Class	126
95-8727B	Mercedes	Mercedes CL-Class	127
95-8727W	Mercedes	Mercedes CL-Class	127
95-8731	Mercedes	Mercedes Sprinter	127
95-8732B	Mercedes	Mercedes E-Class	127
95-8733B	Mercedes	Mercedes C-Class	127
95-8734B	Mercedes	Mercedes S-Class	128
95-8734W	Mercedes	Mercedes S-Class	128
95-8735B	Mercedes	Mercedes SL-Class	128
95-8901	Subaru	Subaru Legacy/Outback	101
95-8902	Subaru	Subaru Impreza/WRX STI /WRX / Forester	101
95-8903B	Subaru	Subaru Legacy Outback	101
95-8903S	Subaru	Subaru Legacy Outback	101
95-8904B	Subaru	Subaru Legacy Outback (Radio mounts at an angle to look more like a factory install)	102
95-8905B	Subaru	Subaru Impreza	102
95-8906HG	Subaru	Subaru Legacy / Outback	102
95-8907HG	Subaru	Subaru Impreza XV Crosstrek	102



PRODUCT LOCATOR

PART NUMBER	MAKE	DESCRIPTION	PAGE
TURBO KITS			
95-8908HG	Subaru	Subaru Impreza	102
95-8909	Subaru	Subaru Legacy / Outback	103
95-8911HG	Subaru	Subaru Ascent	103
95-8912HG	Subaru	Subaru BRZ	103
95-9000	Universal	Universal DDIN housing	129
95-9009	VW	Volkswagen Touareg/Touareg 2	119
95-9011B	VW	Volkswagen Multi Kit	119
95-9012	VW	Volkswagen Golf/GTI/Jetta (not new style)/Passat	119
95-9015HG	VW	Volkswagen Toureg	120
95-9110B	Audi	Audi A4/A5	122
95-9113B	Audi	Audi A4/A5	122
95-9114B	Audi	Audi A4/A5	123
95-9306B	BMW	BMW 3 Series (Without NAV)/M3 (Without NAV)	124
95-9307B	BMW	BMW 5-Series	124
95-9308B	BMW	BMW X5	124
95-9310B	BMW	BMW 3-Series	125
95-9311B	BMW	BMW 3-Series	125
95-9312B	BMW	BMW 3-Series	125
95-9313B	BMW	BMW 3-Series	125
95-9314B	BMW	BMW 5-Series	125
95-9327B	BMW	BMW 1-Series	125
95-9403B	Land Rover	Land Rover Evoque	129
95-9405B	Land Rover	Land Rover LR2/LR3/Range Rover Sport	129
95-9406B	Land Rover	Land Rover LR2/LR3/Range Rover Sport	129
95-9607B	Porsche	Porsche 911 / Cayman / Boxster	120
95-9608B	Porsche	Porsche 911	120
95-9609B	Porsche	Porsche Cayenne	121
95-9610B	Porsche	Porsche Cayenne	121
95-9611B	Porsche	Porsche Cayenne	121
95-9612B	Porsche	Porsche Cayenne	121
95-9613B	Porsche	Porsche Macan	121
95-9614B	Porsche	Porsche Macan	121
95-9615B	Porsche	Porsche Macan	121
95-9616B	Porsche	Porsche Macan	121
95-9700	Harley-Davidson	Harley-Davidson Street Glide / Electra GLide / Ultra / Limited / Road Glide	48
95-9999	Universal	ISO Trim	130
95-HDIF	Harley-Davidson	Harley-Davidson Touring	50
95-HDIF2	Harley-Davidson	Harley-Davidson Touring	50
98-5999	Ford	Ford Turbo Pocket	12
98-7499	Nissan	Nissan Turbo Pocket	99
98-7599	Mazda	Mazda Turbo Pocket	83
98-8999	Mitsubishi	Mitsubishi / Subaru / Volkswagen Under Radio Pocket	86
98-9306	BMW	BMW 3 Series (w/o NAV)	124
99-1003	Hyundai/ Kia	Kia Sephia / Sportage/ Rio / Spectra	61
99-1005	Hyundai/ Kia	Kia Sedona/ Kia Spectra	61
99-1006	Hyundai/ Kia	Kia Sedona EX / LX W/Sport Package	61
99-1007	Hyundai/ Kia	Kia Rio	61
99-1008	Hyundai/ Kia	Kia Sorrento LX/ Kia Spectra	62
99-5852CH	Ford	Ford Explorer	28
99-5854B	Ford	Ford Fusion	29
99-5855CH	Ford	Ford Edge	29
99-5856B	Ford	Transit	29
99-5857B	Ford	Ranger	30
99-5858CH	Ford	Explorer	30
DP-5859	Ford	Full Size Trucks and SUVs	30
99-2001	General Motors	Buick/Cadillac/Chevrolet/Oldsmobile/Pontiac/Isuzu Multi-Kit (Oversize General Motors Radio)	32
99-2002	General Motors	Cadillac Eldorado Seville (console shift only)	32
99-2003	General Motors	General Motors Multi-Kit	32
99-2004	General Motors	Cadillac DeVille (column shift only)/ Cadillac Catera	32

PRODUCT LOCATOR

PART NUMBER	MAKE	DESCRIPTION	PAGE
TURBO KITS			
99-2005	General Motors	Cadillac Eldorado/SeVille /DeVille /DeVille Concours (console shift only)	32
99-2006	General Motors	Cadillac CTS & SRX	32
99-2006G	General Motors	Cadillac CTS & SRX	33
99-2007	General Motors	Cadillac Escalade (Including ESV & EXT)	33
99-2008	General Motors	Cadillac DTS & SRX	33
99-2009	General Motors	General Motors Suzuki Multi-Kit	33
99-2010	Cadillac	Cadillac STS	33
99-2011	General Motors	General Motors Multi-Kit	33
99-2011	Suzuki	Suzuki Multi	100
99-2020	General Motors	Buick Regal	33
99-2021	General Motors	Buick Lacrosse	34
99-2022B	General Motors	Buick Regal	34
99-2022BR	General Motors	Buick Regal	34
99-2023B	General Motors	Buick Regal Kit	34
99-2023BR	General Motors	Buick Regal Kit	34
99-3000	General Motors	Chevrolet General MotorsC Full Size Truck	34
99-3000B	General Motors	Chevrolet General MotorsC Full Size Truck (Blue)	34
99-3000G	General Motors	Chevrolet General MotorsC Full Size Truck (Grey)	34
99-3000R	General Motors	Chevrolet General MotorsC Full Size Truck (Red)	35
99-3000BG	General Motors	Chevrolet General MotorsC Full Size Truck (Beige)	35
99-3000BR	General Motors	Chevrolet General MotorsC Full Size Truck (Brown)	35
99-3001	General Motors	Chevrolet General MotorsC Full Size Truck	35
99-3002	General Motors	Cadillac Chevrolet General MotorsC Truck Multi-Kit	35
DP-3002B	General Motors	General Motors Trucks/SUV	35
DP-3003	General Motors	General Motors Trucks	36
99-3009	General Motors	Chevrolet Camaro & Pontiac Firebird	36
99-3010S	General Motors	Chevrolet Camaro	36
99-3010S-LC	General Motors	Chevrolet Camaro	36
99-3011S	General Motors	Chevrolet Cruze	37
99-3012G	General Motors	Chevrolet Sonic	37
99-3012G-LC	General Motors	Chevrolet Sonic	37
99-3014G	General Motors	Chevy Silverado / General MotorsC Sierra	37
99-3015G	General Motors	Chevrolet / General MotorsC Tahoe / Suburban / Yukon	37
99-3016G	General Motors	Chevrolet Colorado General Motors Canyon	37
99-3017B	General Motors	Chevrolet Trax	37
99-3018HG	General Motors	Cadillac CTS	38
99-3018S	General Motors	Cadillac CTS	38
99-3019B	General Motors	Chevrolet Malibu	39
99-3020B	General Motors	Chevrolet Cruze	39
99-3020HG	General Motors	Chevrolet Cruze	39
DP-3021B	General Motors	Chevrolet Corvette	39
99-3022B	General Motors	Chevrolet Equinox	39
99-3023HG	General Motors	Chevrolet Trax	40
99-3024B	General Motors	Chevrolet Impala	40
99-3028S	General Motors	Chevrolet Camaro	40
99-3031B	General Motors	Captiva Sport	40
99-3030B	General Motors	Cadillac XLR	41
99-3033	General Motors	Chevrolet Impala Caprice	41
99-3042	General Motors	Chevrolet S10 & S15 Pickup/Blazer General MotorsC Jimmy/Camaro	41
99-3042	General Motors	Saturn/Pontiac Firebird	41
99-3043	General Motors	Chevrolet S10 & T10 Pickup/ General MotorsC Sonoma/ Blazer Jimmy	41
99-3043	General Motors	Isuzu Hombre / Olds Bravada	41
99-3043G	General Motors	Chevrolet S10 & T10 Pickup/ General MotorsC Sonoma / Blazer Jimmy	41
99-3043G	General Motors	Isuzu Hombre / Olds Bravada	41
99-3045	General Motors	S-10/T-10/Sonoma/Blazer/Jimmy/Hombre/Bravada	41
99-3045G	General Motors	S-10/T-10/Sonoma/Blazer/Jimmy/Hombre/Bravada	41
99-3051	General Motors	Chevrolet Corvette	41
99-3100	General Motors	Saturn (All Models)	42
99-3105	General Motors	Saturn	42



PRODUCT LOCATOR

PART NUMBER	MAKE	DESCRIPTION	PAGE
TURBO KITS			
99-3107G	General Motors	Saturn Astra	42
99-3107S	General Motors	Saturn Astra	42
99-3108	General Motors	Saturn Multikit	42
99-3300	General Motors	Chevrolet/Oldsmobile/Pontiac Multi-Kit	42
99-3301	General Motors	General Motors Multi-Kit	43
99-3302	General Motors	Multi-kit	43
99-3302S	General Motors	Multi-kit	43
99-3303B	General Motors	Chevrolet Malibu & Malibu Maxx/Cobalt/Pontiac G6	43
99-3304	General Motors	Chevrolet Corvette/ Uplander / Pontiac Montana SV6/ Saturn Relay	43
99-3304	General Motors	Buick Terazza/ Hummer H3	43
99-3305	General Motors	General Motors Multi-Kit	44
99-3306	General Motors	Chevrolet Aveo / Pontiac G3	44
99-3307G	General Motors	Chevrolet Equinox	44
99-3308G	General Motors	Chevrolet Equinox / Terrain	44
99-3309B	General Motors	Chevrolet Spark	44
99-3309B-LC	General Motors	Chevrolet Spark	44
99-3310B	General Motors	Chevrolet Traverse / General MotorsC Acadia / Buick Enclave	45
99-3311B	General Motors	Chevrolet Camaro	45
99-3314G	General Motors	Chevrolet Malibu with Manual Climate Controls	45
99-3320	General Motors	Pontiac Grand Am /Sunfire /Grand Prix/Bonneville / Firebird/Trans Am	45
99-3400	General Motors	Chevrolet/ Geo/ Isuzu/ Honda Multi-Kit	46
99-3410	General Motors	Chevrolet Tracker/Geo Metro/Suzuki Swift /Geo Tracker	46
99-3410	General Motors	Suzuki Sidekick / Grand Vitara /XL7 /Aerio/Esteem	46
99-3411	General Motors	GEO METRO/SUZUKI SWIFT	46
99-3412	General Motors	Geo Prizm	46
99-3413	General Motors	Chevrolet Prizm/ Toyota Corolla	46
99-3527	General Motors	Pontiac Grand Prix	46
99-3528	General Motors	Pontiac GTO	47
99-3900	General Motors	Chevrolet/Oldsmobile/Pontiac Multi-Kit	47
99-4000	General Motors	General Motors Buick/Cadillac/Chevrolet/General MotorsC/Oldsmobile/Pontiac	47
99-4000	General Motors	Saturn Premium Multi-Kit w/ Pocket	47
99-4012	General Motors	General Motors Buick/Cadillac/Chevrolet/General MotorsC/Oldsmobile/Pontiac	47
99-4012	General Motors	Saturn Premium Pullout Multi-Kit w/Flat 1/2" & 1" Extensions	47
99-4500	General Motors	General Motors Buick/Cadillac/Chevrolet/General MotorsC/Oldsmobile/Pontiac	47
99-4500	General Motors	Saturn Multi-Kit 1/2" Extension	47
99-4544	General Motors	General Motors Buick/Cadillac/Chevrolet/General MotorsC/Oldsmobile/Pontiac	47
99-4544	General Motors	Saturn Premium Multi-Kit w/ EQ Option & Mounting Brackets	47
99-4545	General Motors	General Motors Buick/Cadillac/Chevrolet/General MotorsC/Oldsmobile/Pontiac	48
99-4545	General Motors	Saturn Premium Multi-Kit w/ EQ Option	48
99-4644	General Motors	General Motors Buick/Cadillac/Chevrolet/General MotorsC/Oldsmobile/Pontiac	48
99-4644	General Motors	Saturn Premium Multi-Kit w/ mounting brackets	48
99-4700	General Motors	General Motors Buick/Cadillac/Chevrolet/General MotorsC/Oldsmobile/Pontiac/Saturn 82-05 Multi-Kit	48
99-5000	Ford	Ford Thunderbird /Lincoln LS	12
99-5025	Ford	Ford Mustang	13
99-5026	Ford/Lincoln/Mercury	Mustang/Explorer/Expedition/Aviator Navigator/Mountaineer	13
99-5027	Ford	Ford Multikit	13
99-5028	Ford	Ford Expedition Navigator w/ factory NAV / Lincoln Navigator w/ factory NAV	13
99-5200	Mercury/Ford	Cougar/Focus	13
99-5510	Ford	Ford/Lincoln/Mercury Multi-Kit	13
99-5512	Ford	Ford/Lincoln/Mercury/Mazda Snap-In Style Radio Replacement Multi-Kit	13
99-5600	Ford	Ford/Lincoln/Mercury/Mazda Multi-Kit	13
99-5700	Ford	Ford/Lincoln/Mercury/Jeep/Eagle/AMC/Mazda/Nissan Multi-Kit	14
99-5715	Ford	Ford Taurus/ Mercury Sable w/o Electronic Climate Controls	15
99-5715LD	Ford	Ford Taurus/ Mercury Sable w/o Electronic Climate Controls	15
99-5715LDS	Ford	Ford Taurus/ Mercury Sable w/o Electronic Climate Controls	15
99-5716/99-5717	Ford	Ford Taurus/ Mercury Sable w/o Electronic Climate Controls	15
99-5718/99-5719	Ford	Ford Taurus	16
99-5720	Ford	Ford Escort/ Mercury Tracer ZX2	16
99-5722	Ford	Ford Taurus (all NAV equipped models)	16

PRODUCT LOCATOR

PART NUMBER	MAKE	DESCRIPTION	PAGE
TURBO KITS			
99-5800	Ford	Ford F150 Truck/Expedition	17
99-5801	Ford	Ford F150 Truck/Expedition w/o Pocket	17
99-5802	Ford	Ford/Lincoln/Mercury/Mazda Multi-Kit	17
99-5804	Ford	Ford/Lincoln/Mercury Truck Multi-Kit	17
99-5806	Ford	Mercury Cougar 1999-2002 Ford Focus	17
99-5807	Ford	Ford Mercury	17
99-5808	Ford	Ford Mercury	17
99-5809	Ford	Lincoln Continental	18
99-5810	Ford	Lincoln Town Car	18
99-5812	Ford	Ford/Lincoln/Mercury	18
99-5813	Ford	Lincoln Navigator MKX & MKZ / Zephyr	18
99-5814	Ford	Ford Escape/Mercury Mariner/Mazda Tribute	18
99-5814S	Ford	Ford Escape/Mercury Mariner/Mazda Tribute	18
99-5816	Ford	Ford Focus	19
99-5819	Ford	Ford F-150 (base model only)	19
99-5820B	Ford	Ford F-150 (excluding base model)	19
99-5820CB	Ford	Ford F-150	19
99-5820DW	Ford	Ford F-150	20
99-5820HG	Ford	Ford F-150 Select Models 2	20
99-5820SS	Ford	Ford F-150	20
99-5821B	Ford	Ford Fusion/Mercury Milan (Matte Black)	20
99-5821S	Ford	Ford Fusion/Mercury Milan (Silver)	20
99-5821R	Ford	Ford Fusion/Mercury Milan (Red)	20
99-5821BL	Ford	Ford Fusion/Mercury Milan (Blue)	20
99-5822B	Ford	Ford F-150 (matte black)	21
99-5822MM	Ford	Ford F-150 Lariat (Milano Maple)	21
99-5822CM	Ford	Ford F-150 King Ranch (Curly Maple)	21
99-5822AS	Ford	Ford F-150 Platinum (Ash Satin)	21
99-5824B	Ford	Ford Transit / International Multi-Kit	22
99-5824S	Ford	Ford Transit / International Multi-Kit	22
99-5824CH	Ford	Ford Transit / International Multi-Kit	22
99-5825B	Ford	Ford Fiesta	22
99-5825S	Ford	Ford Fiesta	22
99-5827B	Ford	Ford Focus	23
99-5831B	Ford	FORD Transit-Connect with Factory 4.2" Screen (Black)	23
99-5831G	Ford	FORD Transit-Connect with Factory 4.2" Screen (Gray and Black Two-Toned)	23
99-5832G	Ford	Ford Transit without Factory 4.2" Screen	24
99-5833B	Ford	Ford Escape with Factory 4.2" Display Screen	24
99-5834CH	Ford	Ford F-150	24
99-5835G	Ford	Transit without NAV, with AM/FM/CD radio	24
99-5838CH	Ford	Ford Mustang with factory 4.2" Screen	25
99-5839CH	Ford	Ford Mustang	25
99-5840CH	Ford	Ford Mustang with factory 8" Screen	25
99-5841B	Ford	Ford Fusion	25
99-5842B	Ford	Ford Flex	26
99-5842T	Ford	Ford Flex	26
99-5843B	Ford	Ford Focus with factory 4.2" Screen	26
99-5846B	Ford	F-150 with factory 4.2" screen	27
99-5847CH	Ford	Explorer with factory 4.2" screen	27
99-5848CH	Ford	Edge excluding hybrid	27
99-5849CH	Ford	F-150	27
99-5850B	Ford	F-250 XL models not equipped with CD player	28
99-5851CH	Ford	Edge with factory 4.2" screen	28
99-5852CH	Ford	Explorer	28
99-6000	Chrysler	Chrysler Plymouth/Dodge/Jeep/Eagle Multi-Kit	1
99-6229	Chrysler	Chrysler Plymouth/Dodge/Jeep Multi-Kit	1
99-6500	Chrysler	Chrysler Plymouth/Dodge/Jeep/Eagle/Ford/Lincoln/Mercury	1
99-6501	Chrysler	Chrysler Plymouth/Dodge/Jeep/Eagle/Ford/Lincoln/Mercury	1
99-6502	Chrysler	Chrysler Cirrus/Dodge Stratus/Plymouth Breeze/Sebring Convertible	1



PRODUCT LOCATOR

PART NUMBER	MAKE	DESCRIPTION	PAGE
TURBO KITS			
99-6503	Chrysler	Jeep Chrysler/Plymouth/Dodge	1
99-6504	Chrysler	Jeep Chrysler/Plymouth/Dodge	1
99-6505	Chrysler	Chrysler Jeep/Dodge/Plymouth Multi-Kit	1
99-6506	Chrysler	Chrysler Pacifica	2
99-6507	Chrysler	Chrysler/Dodge/Jeep	2
99-6509	Chrysler	Dodge Sprinter	2
99-6510	Chrysler	Chrysler/Dodge/Jeep	2
99-6511	Chrysler	Chrysler/Dodge/Jeep	2
99-6512	Chrysler	Dodge Sprinter	2 / 126
99-6512	Mercedes	Mercedes Sprinter	2 / 126
99-6513B	Chrysler	Jeep Grand Cherokee	2
99-6514B	Dodge	Dodge Charger with 4.3" Screen	3
99-6515B	Fiat	Fiat 500	3
99-6515W	Fiat	Fiat 500	3
99-6516B	Chrysler	Chrysler 300	3
99-6517HG	Dodge	Dodge Dart without factory 8.4" screen	3
99-6518B	Ram	Ram 1500/2500/3500 without factory 8.4" screen	3
99-6519B	Dodge	Dodge Charger without factory NAV (Black)	4
99-6519CF	Dodge	Dodge Charger without factory NAV	4
99-6519S	Dodge	Dodge Charger without factory NAV (Silver)	4
99-6520B	Dodge	Dodge Journey with factory 4.3" screen	4
99-6521B	Fiat	Fiat 500L	4
99-6523	Ram	Ram Promaster	5
99-6525B	Chrysler	Chrysler 300	5
99-6525HG	Chrysler	Chrysler 300	5
99-6526S	Jeep	Jeep Cherokee	5
99-6526BZ	Jeep	Jeep Cherokee	5
99-6527B	Ram	Ram Truck with 8" Screen	5
99-6531HG	Ram	Ram Promaster City	6
99-6532B	Jeep	Jeep Renegade	6
99-6536S	Jeep	Jeep Grand Cherokee with 8" Screen	7
99-6536BZ	Jeep	Jeep Grand Cherokee with 8" Screen	7
99-6537B	Dodge	Dodge Durango with 8" Screen	7
99-6538B	Chrysler	Chrysler 200	7
99-6540	Chrysler	Dodge Full Size Van	8
99-6543HG	Chrysler	Chrysler Pacifica	8
99-6544B	Fiat	500	8
99-6545B	Jeep	Compass Sport	8
99-6548B	Dodge	Charger/Magnum (without NAV)	9
99-6548CF	Dodge	Charger/Magnum (without NAV)	9
99-6548S	Dodge	Charger/Magnum (without NAV)	9
99-6550B	Chrysler	300	9
DP-6551	Dodge	Ram	10
99-6552B	Dodge	Charger	10
99-6553B	Chrysler 300	Chrysler	10
99-6700	Chrysler	Chrysler/Plymouth/Dodge/Ford/Lincoln/Mercury/Jeep/Eagle	12
99-7000	Chrysler/Mitsubishi	Plymouth/Dodge/Eagle/Mitsubishi Imports	12
99-7000	Mitsubishi	Mitsubishi Multi-Kit	83
99-7001	Mitsubishi	Mitsubishi Multi-Kit	83
99-7006	Chrysler/Mitsubishi	Eagle Talon/Mitsubishi Eclipse	12
99-7006	Mitsubishi	Mitsubishi Eclipse Eagle Talon	83
99-7007	Mitsubishi	Mitsubishi Eclipse/Montero Sport	83
99-7008	Mitsubishi	Mitsubishi Outlander	83
99-7009	Mitsubishi	Mitsubishi Endeavor	83
99-7010	Mitsubishi	Mitsubishi Eclipse	84
99-7011	Mitsubishi	Mitsubishi Lancer	84
99-7012	Mitsubishi	Mitsubishi Galant	84
99-7013TB	Mitsubishi	Mitsubishi Outlander	84
99-7014B	Mitsubishi	Mitsubishi Outlander Sport	84



PRODUCT LOCATOR

PART NUMBER	MAKE	DESCRIPTION	PAGE
TURBO KITS			
99-7015CHG	Mitsubishi	Mitsubishi Outlander	85
99-7016GHG	Mitsubishi	Mirage without OE NAV/Mirage G4 without OE NAV	85
99-7018B	Mitsubishi	Mitsubishi Outlander Sport (Black)	85
99-7018CHG	Mitsubishi	Mitsubishi Outlander Sport (Charcoal High Gloss)	85
99-7019	Mitsubishi	Mirage/Mirage G4	86
99-7020	Mitsubishi	Eclipse Cross ES	86
99-7301	Hyundai/ Kia	Hyundai Multi-Kit	62
99-7308	Hyundai/ Kia	Hyundai Accent/ Elantra/ Accent/ Sonata/ Tiburon	62
99-7309	Hyundai/ Kia	Hyundai Elantra/ Sonata/ Tiburon/ Santa Fe	62
99-7310	Hyundai/ Kia	Hyundai Accent	62
99-7312	Hyundai/ Kia	Hyundai Tiburon	62
99-7313	Hyundai/ Kia	Hyundai Elantra/ Sonata/ Tiburon/ Kia Optima	62
99-7315	Hyundai/ Kia	Hyundai Tucson	63
99-7316	Hyundai/ Kia	Hyundai XG 300/ XG 350	63
99-7317	Hyundai/ Kia	Kia Sportage	63
99-7318	Hyundai/ Kia	Kia Spectra	63
99-7319	Hyundai/ Kia	Kia Amanti	63
99-7320	Hyundai/ Kia	Hyundai Sonata	64
99-7321	Kia/Hyundai	KIA Rio/Hyundai Accent	64
99-7322	Hyundai	Hyundai Azera	64
99-7323	Hyundai	Hyundai Entourage KIA Sedona	64
99-7324	Kia	KIA Optima	64
99-7325B	Hyundai	Hyundai Santa Fe	65
99-7326	Hyundai	Hyundai Elantra	65
99-7328	Kia	KIA Sorento	65
99-7329	Kia	KIA Rondo	65
99-7330	Kia	KIA Spectra	66
99-7331	Kia	KIA Amanti	66
99-7332	Hyundai	Hyundai Elantra (for factory radio delete option)	66
99-7333	Hyundai	Hyundai Sonata	66
99-7334	Kia	Kia Borrego	66
99-7335S	Hyundai	Hyundai Veracruz	66
99-7336S	Hyundai	Hyundai Genesis Coupe	67
99-7337B	Kia	Kia Soul	67
99-7338B	Kia	Kia Forte	67
99-7338HG	Kia	Kia Forte	67
99-7338S	Kia	Kia Forte	67
99-7339B	Hyundai	Hyundai Genesis Coupe	67
99-7339S	Hyundai	Hyundai Genesis Coupe	68
99-7340B	Kia	Kia Sorento	68
99-7341B	Hyundai	Hyundai Tucson	68
99-7342	Hyundai	Hyundai Sonata	68
99-7343	Hyundai	Hyundai Sonata w/o NAVI	68
99-7344CH	Kia	Kia Sportage	68
99-7344G	Kia	Kia Sportage	69
99-7345B	Kia	Kia Optima	69
99-7346B	Hyundai	Hyundai Elantra	69
99-7347B	Hyundai	Hyundai Accent	69
99-7348B	Hyundai	Hyundai Accent (without factory radio)	69
99-7349B	Kia	Kia Soul	69
99-7350B	Hyundai	Hyundai Veloster	70
99-7352B	Hyundai	Hyundai Genesis Coupe	70
99-7353CH	Kia	Kia Rio	70
99-7354B	Hyundai	Hyundai Santa Fe	70
99-7355B	Kia	Kia Sorento	71
99-7356B	Kia	Kia Forte	71
99-7357HG	Hyundai	Hyundai Elantra GT	71
99-7358	Hyundai	Hyundai/ Kia Multi	71
99-7359B	Kia	Kia Optima	71



PRODUCT LOCATOR

PART NUMBER	MAKE	DESCRIPTION	PAGE
TURBO KITS			
99-7360B	Kia	Kia Soul	72
99-7362B	Hyundai	Hyundai Elantra	72
DP-7363B	Hyundai	Hyundai Sonata	72
99-7364B	Hyundai	Hyundai Tucson	72
99-7365B	Kia	Kia Sedona	72
99-7366B	Kia	Kia Sorento	73
99-7367B	Kia	Kia Rio (Black) Specific for models with factory push to start	73
99-7367HG	Kia	Kia Rio (High Gloss) Specific for models with factory push to start	73
99-7368B	Kia	Kia Rio	73
99-7368HG	Kia	Kia Rio	73
99-7369B	Hyundai	Hyundai Tucson	73
99-7370B	Kia	Kia Picanto	73
99-7376B	Hyundai	Hyundai Elantra	74
99-7377B	Kia	Kia Optima	74
99-7378B	Kia	Kia Sportage LX with 5" screen	74
99-7379HG	Hyundai	Hyundai Elantra GT (with NAV)	74
99-7380HG	Hyundai	Hyundai Elantra GT (with NAV)	74
99-7381	Hyundai	Santa Fe with NAV	74
99-7382HG	Kia	Niro without NAV	75
99-7383	Hyundai	Sonata	75
99-7384B	Kia	Optima	75
99-7385B	Hyundai	Santa Fe Sport with NAV	76
99-7386B	Hyundai	Hyundai Santa Fe Sport	76
99-7387HG	Kia	Kia Soul	76
99-7388HG	Kia	Kia Soul	76
99-7389B	Kia	Kia Sportage	77
99-7390B	Kia	Kia Sportage	77
99-7391B	Kia	Kia Rio	77
99-7392B	Hyundai	Hyundai Kona	77
99-7393B	Hyundai	Hyundai Accent	78
99-7394B	Kia	Kia Forte	78
99-7396	Hyundai	Santa Fe	78
99-7397B	Kia	Soul	78
99-7401	Nissan	Nissan Multi-Kit	89
99-7402	Nissan	Nissan 350Z	89
99-7403	Nissan	Nissan Pathfinder (LE Models) Infiniti QX4	89
99-7404	Nissan	Nissan Maxima	89
99-7405	Nissan	Nissan Titan (without dual zone climate controls)	89
99-7406	Nissan	Nissan Titan & Armada (without dual zone climate control)	89
99-7409	Nissan	Nissan Maxima 240SX	90
99-7410	Nissan	Nissan Sentra 200SX	90
99-7411	Nissan	Nissan 300ZX	90
99-7412	Nissan	Nissan Quest Mercury Villager	90
99-7413	Nissan	Nissan Altima	90
99-7414	Nissan	Nissan Sentra	90
99-7414G	Nissan	Nissan Sentra	90
99-7415	Nissan	Nissan Quest Mercury Villager	90
99-7416	Nissan	Nissan Maxima	90
99-7417	Nissan	Nissan Multi-Kit	91
99-7418	Nissan	Nissan Altima	91
99-7419	Nissan	Nissan Altima	91
99-7421	Nissan	Nissan Maxima	91
99-7422	Nissan	Nissan Sentra	91
99-7423	Nissan	Nissan Altima	92
99-7424	Nissan	Nissan Titan	92
99-7425	Nissan	Nissan Rogue	92
99-7426	Nissan	Nissan Murano	92
99-7427B	Nissan	Nissan Maxima	92
99-7428B	Nissan/Suzuki	Nissan Frontier LE/Pro-4X/SE w/ V6 /Frontier/Xterra S	93

PRODUCT LOCATOR

PART NUMBER	MAKE	DESCRIPTION	PAGE
TURBO KITS			
99-7428B	Nissan/Suzuki	Offroad/SE/Xterra Pro 4X/Suzuki Equator Crew Cab	93
99-7428G	Nissan/Suzuki	Nissan Frontier LE/Pro-4X/SE w/ V6/Frontier/Xterra S	93
99-7428G	Nissan/Suzuki	Offroad/SE/Xterra Pro 4X/Suzuki Equator Crew Cab	93
99-7477	Nissan	Nissan Hardbody Pathfinder	93
99-7500	Mazda	Mazda Multi-Kit (Dash Bezel Mount)	78
99-7501	Mazda	Mazda Multi-Kit (Sub Dash Mount)	79
99-7502	Mazda	Mazda MPV	79
99-7504	Mazda	Mazda 3	79
99-7505	Mazda	Mazda Multi-Kit	79
99-7506	Mazda	Mazda MX-5 Miata	79
99-7508	Mazda	Mazda CX7	79
99-7509	Mazda	Mazda 5	79
99-7510	Mazda	Mazda RX8	80
99-7510HG	Mazda	Mazda RX8	80
99-7511S	Mazda	Mazda 6	81
99-7514B	Mazda	Mazda 3	81
99-7515B	Mazda	Mazda RX8	81
99-7515HG	Mazda	Mazda RX8	81
99-7516B	Mazda	Mazda CX9	81
99-7517S	Mazda	Mazda BT-50	81
99-7518B	Mazda	Mazda 2	81
99-7519B	Mazda	Mazda Miata / International Muti-Kit	81
99-7520B	Mazda	Mazda CX7	81
99-7521B	Mazda	Mazda 5	82
99-7522B	Mazda	Mazda CX5	82
99-7523S	Mazda	Mazda 6	82
99-7524B	Mazda	Mazda 6	82
99-7525S	Mazda	Mazda 5	82
99-7526B	Mazda	Mazda 33	82
99-7527S	Mazda	Mazda 5	83
99-7578	Nissan	Nissan Hardbody Pathfinder	93
99-7579	Nissan	Nissan Pathfinder	93
99-7580	Nissan	Nissan Frontier Xterra	93
99-7581	Nissan	Nissan Pathfinder Frontier & Xterra	93
99-7602	Nissan	Nissan 350Z	93
99-7603	Nissan	Nissan Versa	93
99-7604B	Infiniti	Infiniti G35	87
99-7604T	Infiniti	Infiniti G35	87
99-7604	Infiniti	Infiniti G35	86
99-7605A	Infiniti	Infiniti G35 Sedan Coupe	88
99-7606	Nissan	Nissan Titan & Armada (With Dual Zone Climate Control)	94
99-7607B	Nissan	Nissan 370Z	94
99-7608	Nissan	Nissan Cube	94
99-7609G	Infiniti	Infiniti I30/I35	88
99-7610B	Nissan	Nissan Juke	94
99-7610HG	Nissan	Nissan Juke	94
99-7611	Nissan	Nissan Rogue	94
99-7612A	Nissan	Murano Kit	94
99-7612B	Nissan	Nissan Murano	95
99-7613	Nissan	Nissan Versa, Juke, Rogue	95
99-7614	Nissan	Nissan NV & Quest	95
99-7616	Nissan	Nissan Rogue, S with Special Edition & SV models	95
99-7617CHG	Nissan	Nissan Altima	95
99-7618G	Nissan	Nissan Sentra	95
99-7619	Nissan	Nissan Titan Frontier Xterra with 4.3" color display	96
99-7620B	Nissan	Nissan Armada/Pathfinder	96
99-7621	Nissan	Versa SL/SV/Versa/Versa Note	96
99-7622HG	Nissan	Nissan Rogue	96
99-7623	Nissan	NV200	97



PRODUCT LOCATOR

PART NUMBER	MAKE	DESCRIPTION	PAGE
TURBO KITS			
99-7624	Nissan	Nissan Multi-Kit	97
99-7625B	Infiniti	Infiniti G37	88
99-7626HG	Nissan	Nissan Pathfinder (Without auto climate or NAV)	97
99-7627HG	Nissan	Nissan Pathfinder with Auto A/C and without NAV	97
99-7628BHG	Nissan	Nissan Murano	97
99-7629S	Nissan	Nissan Armada Titan with Factory NAV	97
99-7630	Nissan	Nissan Maxima	98
99-7631B	Nissan	Titan/Titan XD	98
99-7633	Nissan	Maxima with factory NAV	98
99-7635	Nissan	Nissan/Suzuki	98
99-7636B	Nissan	Nissan Kicks	98
99-7637	Nissan	Nissan Altima	99
99-7638	Nissan	Nissan Sentra	99
99-7639HG	Nissan	Titan	99
99-7802CH	Honda	CR-V	51
99-7803G	Honda	Honda Accord	51
99-7804B	Honda	Honda Accord	51
99-7804HG	Honda	Honda Accord	52
99-7805CH	Honda	Honda Acura TSX	52
99-7806B	Honda	Acura RL without factory NAV	52
99-7807	Honda	Honda Accord Crosstour with NAV	52
99-7807T	Honda	Honda Accord Crosstour with NA	52
99-7808B	Honda	Acura TL	52
99-7809B	Honda	Acura TSX	53
99-7810B	Honda	Honda HRV	53
99-7811B	Honda	Honda Pilot (Black)	53
99-7811HG	Honda	Honda Pilot (High Gloss)	53
99-7812B	Honda	Honda Civic LX	54
99-7814	Acura/Honda	Acura/Honda Mult-Kit	54
99-7815B	Acura	Acura TL	54
99-7816G	Honda	Honda Civic	54
99-7816T	Honda	Honda Civic	54
99-7817HG	Honda	Honda CRV	54
99-7819	Honda	Honda Pilot (with factory NAV)	54
99-7820B	Acura	MDX	55
99-7821B	Honda	Civic	55
99-7860	Honda	Honda Civic SI	55
99-7861	Honda	Honda Pilot	55
99-7862	Honda	Honda Accord	55
99-7863	Honda	Honda Element	56
99-7866	Honda	Acura MDX	56
99-7867	Honda	Acura RSX Type-S	56
99-7868	Honda	Acura CL / TL	56
99-7869	Honda	Honda Odyssey	56
99-7870G	Honda	Honda Ridgeline	57
99-7870T	Honda	Honda Ridgeline	57
99-7872	Honda	Honda Fit	57
99-7873	Honda	Honda CRV	57
99-7874	Honda	Honda Accord (without dual zone climate controls)	57
99-7874T	Honda	Honda Accord (without dual zone climate controls)	57
99-7875	Honda	Honda Accord (with dual zone climate controls)	57
99-7875T	Honda	Honda Accord (with dual zone climate controls)	57
99-7876	Honda	Honda Pilot	58
99-7877S	Honda	Honda Fit	58
99-7877B	Honda	Honda Fit	58
99-7878B	Honda	Honda Insight	58
99-7879	Honda	Honda Cruze	58
99-7880B	Honda	Honda Odyssey	58
99-7881G	Honda	Honda Civic	59



PRODUCT LOCATOR

PART NUMBER	MAKE	DESCRIPTION	PAGE
TURBO KITS			
99-7882B	Honda	Honda Civic	59
99-7883HG	Honda	Honda Fit	59
99-7888	Honda	Honda Accord/Odyssey/Prelude/Acura TL/Vigor	59
99-7888	Honda	Integra/ Legend/Isuzu Oasis	59
99-7889	Honda	Honda Prelude	59
99-7890	Honda	Honda Accord/Odyssey/Acura CL/Vigor /Integra	59
99-7890	Honda	Legend/ Isuzu Oasis	59
99-7891	Honda	Honda Civic Custom Kit	60
99-7892	Honda	Honda Accord/Odyssey/Acura CL/Vigor/Integra	60
99-7892	Honda	Legend/ Isuzu Oasis	60
99-7893	Honda	Honda CRV/ Prelude	60
99-7894	Honda	Honda Accord	60
99-7895	Honda	Honda Accord w/ Pocket	60
99-7896	Honda	Honda Civic	60
99-7897	Honda	Honda Civic/ Civic Hybrid	60
99-7898	Honda	Honda Acura Multi-Kit	60
99-7899	Honda	Honda Civic (Excludes Si & 2005 SE Models)	61
99-7950	Suzuki	Suzuki Grand Vitara / XL7 / Aerio	100
99-7951	Suzuki	Suzuki Verona & Forenza/Chevrolet Aveo/Aveo Hatchback	100
99-7952	Suzuki	Suzuki Aerio	100
99-7953	Suzuki	Suzuki Grand Vitara	100
99-7953T	Suzuki	Suzuki Grand Vitara	100
99-7954	Suzuki	Suzuki SX4	101
99-8100	Toyota	Toyota Multi-Kit	103
99-8101	Toyota	Toyota Multi-Kit	104
99-8104	Toyota	Toyota Multi-Kit	104
99-8140	Toyota	Toyota Pickup /4Runner/T100/Tacoma	104
99-8150	Lexus	Lexus ES Series	116
99-8151	Lexus	Lexus IS Series	116
99-8152	Lexus	Lexus GS Series	116
99-8153	Lexus	Lexus LS Series	116
99-8154	Lexus	Lexus GS Series	116
99-8155	Lexus	Lexus ES Series	117
99-8156	Lexus	Lexus LS Series	117
99-8157B	Lexus	Lexus SC Series	117
99-8158G	Lexus	Lexus ES 300/330	117
99-8159S	Lexus	Lexus RX330/350/400H	117
99-8160G	Lexus	Lexus LS430 without factory NAV	118
99-8161S	Lexus	Lexus SC430	118
99-8162G	Lexus	Lexus E350 without Factory NAV	118
99-8163	Lexus	IS 250/350	118
99-8164G/T	Lexus	RX300	118
99-8201	Toyota	Toyota Celica Echo	104
99-8202	Toyota	Toyota Mini Multi-Kit	104
99-8204	Toyota	Toyota Corolla	104
99-8205	Toyota	Toyota Matrix / Pontiac Vibe	104
99-8206	Toyota	Toyota Highlander / 4Runner (Excluding Limited)	105
99-8207	Toyota	Toyota Sequoia / Tundra	105
99-8208	Toyota	Toyota Sienna	105
99-8209	Scion	Scion XA /XB/TC/XD	105
99-8210	Toyota	Toyota 4Runner (Limited Radios)	105
99-8211	Toyota	Toyota Avalon	105
99-8212	Toyota	Toyota Solara	106
99-8212S	Toyota	Toyota Solara	106
99-8213	Toyota	Toyota Prius	106
99-8214TB	Toyota	Toyota Tacoma	106
99-8214TG	Toyota	Toyota Tacoma	106
99-8215	Toyota	Toyota Avalon	106
99-8216	Toyota	Toyota Yaris (EXCLUDES S MODELS)	107



PRODUCT LOCATOR

PART NUMBER	MAKE	DESCRIPTION	PAGE
TURBO KITS			
99-8217	Toyota	Toyota Rav4	107
99-8218	Toyota	Toyota Camry	107
99-8219	Toyota	Toyota FJ Cruiser	107
99-8220	Toyota	Toyota Tundra/ Sequoia	107
99-8220CHG	Toyota	Toyota Tundra	108
99-8220HG	Toyota	Toyota Tundra/ Sequoia	107
99-8222	Toyota	Toyota Highlander	108
99-8222BR	Toyota	Toyota Highlander	108
99-8223	Toyota	Toyota Corolla	108
99-8223S	Toyota	Toyota Corolla	108
99-8224	Toyota	Toyota Matrix	108
99-8225G	Toyota	Toyota Venza	109
99-8226B	Toyota	Toyota Prius	109
99-8227S	Toyota	Toyota 4-Runner	109
99-8228	Toyota	Toyota Hilux	109
99-8229S	Toyota	Toyota Sienna	109
99-8230	Toyota	Toyota Scion	109
99-8231	Toyota	Toyota Camry	109
99-8232B	Toyota	Toyota Camry	110
99-8233B	Toyota	Toyota Avalon	110
99-8234	Toyota	Scion iQ	110
99-8235CHG	Toyota	Toyota Tacoma	110
99-8236	Toyota	Scion FRS	110
99-8237S	Toyota	Toyota Matrix	111
99-8238	Toyota	Toyota Yaris	111
99-8239B	Toyota	Toyota Prius C	111
99-8240B	Toyota	Toyota Prius	111
99-8241	Toyota	Toyota Highlander	111
99-8242G	Toyota	Toyota RAV4	111
99-8243B	Toyota	Toyota Prius V	112
99-8244HG	Toyota	Toyota Avalon	112
99-8245CHG	Toyota	Toyota Corolla	112
99-8246HG	Toyota	Toyota Tundra	112
99-8248B	Toyota	Toyota Highlander	113
99-8249	Toyota	Toyota Camry	113
99-8250	Toyota	Toyota Sienna	113
99-8251B	Toyota	Toyota Tacoma	113
99-8252	Toyota	Toyota Tundra	113
99-8259B	Toyota	Toyota Prius C	113
99-8260B	Toyota	Toyota Highlander (with factory NAV)	113
99-8264HG	Toyota	Toyota Prius	114
99-8265HG	Toyota	Toyota C-HR	114
99-8266BLHG	Toyota	Toyota Camry	114
99-8267	Toyota	Toyota Matrix	114
99-8268	Toyota	Toyota Highlander / Sequoia / Tundra	114
99-8270HG	Toyota	Toyota Corolla Hatchback/Corolla	115
99-8300	Toyota	Toyota Multi	115
99-8710	Mercedes	Mercedes C-Class	126
99-8713	Mercedes	Mercedes SLK	126
99-8715	Mercedes	Smart Fortwo	126
99-8716B	Mercedes	Mercedes GLK	126
99-8720B	Smart	Smart ForTwo	128
99-8721B	Mercedes	Mercedes C-Class	126
99-8722B	Mercedes	Mercedes C-Class	126
99-8723B	Mercedes	Mercedes CLK	127
99-8724B	Mercedes	Mercedes CLK	127
99-8725B	Mercedes	C-Class	127
99-8731	Mercedes	Mercedes Sprinter	127
99-8900	Subaru	Subaru Multi-Kit	101

PRODUCT LOCATOR

PART NUMBER	MAKE	DESCRIPTION	PAGE
TURBO KITS			
99-8901	Subaru	Subaru Legacy Outback (excluding Outback Sport)	101
99-8902	Subaru	Subaru Impreza / WRX/Forester	101
99-8903B	Subaru	Subaru Legacy Outback	102
99-8905B	Subaru	Subaru Impreza	102
99-8906HG	Subaru	Subaru Legacy Outback	102
99-8907HG	Subaru	Subaru Impreza XV Crosstrek	102
99-8908HG	Subaru	Subaru Crosstrek/Impreza	103
99-8909	Subaru	Subaru Legacy Outback	103
99-8910S	Subaru	Subaru Legacy/Outback	103
99-8911HG	Subaru	Subaru Ascent	103
99-8912HG	Subaru	Subaru BRZ	103
99-9000	Universal	Universal Underdash/CD Housing	130
99-9003B	Universal	Black Base with Transparent Smoke Tinted Door	130
99-9003W	Universal	White Base with Transparent Smoke Tinted Door	130
99-9005B	Universal	Universal Marine Cover System	130
99-9006	Universal	Universal Marine Radio Housing	130
99-9008	VW	Volkswagen New Beetle	119
99-9009	VW	Volkswagen Touareg/Touareg 2	119
99-9011	VW	Volkswagen Jetta/GLI /Passat/Eos/CC /TIGUAN	119
99-9013HG	VW	Volkswagen Golf	119
99-9014HG	VW	Volkswagen Jetta	120
99-9100	Audi	Audi (A4,A6,A8) TT Multi-Kit	122
99-9103	Audi	Audi A4 (Concert Radio)	122
99-9105	Audi	Audi A4	122
99-9107B	Audi	Audi A4	122
99-9108B	Audi	Audi A6	122
99-9109B	Audi	Audi A3	122
99-9200	Volvo	Volvo 740 & 760 Series	123
99-9222	Volvo	Volvo Multi-Kit	123
99-9227	Volvo	Volvo S60 / V70	123
99-9228B	Volvo	Volvo XC90	123
99-9229G	Volvo	Volvo S60 / V70	123
99-9230G	Volvo	Volvo S80 / V70	123
99-9300	BMW	BMW 3 Series/318 (All) 99/323/325/328/330	124
99-9301	BMW	BMW 5 Series/ X	124
99-9303	BMW	BMW Z4	124
99-9305	BMW	BMW X3	124
99-9306B	BMW	BMW 1 Series/3 Series (without NAV)	124
99-9302	Mini	Mini Cooper	125
99-9309	Mini	Mini Cooper	125
99-9326B	Mini	Mini Cooper Hardtop Coupe/Cooper Sedan	125
99-9401	Land Rover	Land Rover Freelander	128
99-9402B	Land Rover	Land Rover Range Rover	128
99-9501B	Jaguar	Jaguar S-Type/X-Type	129
99-9501G	Jaguar	Jaguar S-Type/X-Type	129
99-9600	Harley Davidson	Harley Davidson Touring Models	48
99-9604B	Porsche	Porsche Cayenne	120
99-9605B	Porsche	Porsche 911 (996) /Boxster (986)	120
99-9606B	Porsche	Porsche 997 (Black)	120
99-9606G	Porsche	Porsche 997 (Silver)	120
99-9700WR	Harley Davidson	Harley Davidson Street Glide / Electra Glide / Ultra Limited Models	49
99-9713WR	Harley Davidson	Harley Davidson Street Glide / Electra Glide / Ultra Limited Models	49
99-9714WR	Harley Davidson	Harley Davidson Street Glide / Electra Glide / Ultra Limited Models	49
99-9721	Polaris	Polaris Slingshot	50
99-9800	Harley-Davidson	Harley-Davidson Touring FL Touring	49
99-9999	Universal	Universal ISO Trim	130
MPS-GEN01	Polaris	Polaris General 1000	51
MPS-GEN02	Polaris	Polaris General 1000	51
MPS-RZR01	Polaris	Polaris General 1000	51



PRODUCT LOCATOR

PART NUMBER	MAKE	DESCRIPTION	PAGE
PIONEER KITS			
107-CH3B	Jeep	Jeep Wrangler JL/Gladiator	131
107-CH5	Jeep	Jeep Grand Cherokee	132
107-FD1B	Ford	Ford Transit	132
107-GM3B	Chevrolet	Chevrolet Camaro	134
107-GM4B	Chevrolet	Chevrolet Silverado/GMC Sierra	135
107-GM5B	Cadillac	Cadillac SRX	135
107-KI1	Kia	Kia Seltos	135
107-MI1	Mini	Mini Countryman/Paceman	136
107-MZ1B	Mazda / Toyota	Mazda CX-3 / Toyota Yaris	136
107-T01HG	Toyota	Toyota RAV4	136
107-T07HG	Toyota	Toyota Highlander	138
107-UN02	Universal	Universal Floating Mount Kit for Pioneer 6.8" Modular Radios	139
108-CH1B	Jeep	Jeep Wrangler	131
108-CH2B	Dodge	Dodge Ram 1500/2500/3500	132
108-CH4DK	Jeep	Jeep Commander	131
108-CH4G	Jeep	Jeep Commander	132
108-FD1CH	Ford	Ford F-150/250/350/450/550	132
108-FD2B	Ford	Ford F-150	133
108-FD3B	Ford	Ford F-150 / XL / XLT	133
108-FD4CH	Ford	Ford Mustang	133
108-FD5CH	Ford	Ford Mustang	133
108-FD6CH	Ford	Ford Mustang	133
108-FD7B	Ford	Ford Super Duty F-250/350/450/550 XL	133
108-FD8CH	Ford	Ford Explorer	134
108-FD9B	Ford	Ford Ranger	134
108-GM1G	General Motors	Chevrolet Silverado 1500/2500/3500 / GMC Sierra	134
108-GM2B	General Motors	Chevrolet Tahoe/Avalanche / GMC Yukon/Sierra	134
108-GM3B	Chevrolet	Chevrolet Camaro	134
108-KI1	Kia	Kia Seltos	135
108-MI1	Mini	Mini Countryman/Paceman	136
108-T01B	Toyota	Toyota Tundra/Sequoia	136
108-T01HG	Toyota	Toyota Tundra/Sequoia	137
108-T01CHG	Toyota	Toyota Tundra/Sequoia	137
108-T02B	Toyota	Toyota Tacoma	137
108-T02CHG	Toyota	Toyota Tacoma	137
108-T03B	Toyota	Toyota Highlander	137
108-T03BR	Toyota	Toyota Highlander	137
108-T04	Toyota	Toyota Corolla Hatchback	138
108-T05HG	Toyota	Toyota Camry	138
108-T06HG	Toyota	Toyota RAV4	138
108-T07HG	Toyota	Toyota Highlander	138
108-UN01	Universal	Universal Trim	139
108-UN02	Universal	Universal Floating Mount	139
109-KI1	Kia	Kia Seltos	135
109-T07	Toyota	Toyota Highlander	138
109-UN02	Universal	Universal Floating Mount Kit for Pioneer 9" Radios	139
TURBO WIRES			
70-1002	Jeep	Jeep/Eagle - Plugs into Car Harness	146
70-1003	Kia	KIA - Plugs into Car Harness	159
70-1004	Hyundai	Hyundai/KIA - Plugs into Car Harness	157
70-1119	Volvo	Volvo - Plugs into Car Harness	165
70-1120	Volvo	Volvo 240 - Plugs into Car Harness	165
70-1388	Honda	Honda - Plugs into Car Harness	155
70-1398	Toyota	Toyota Daihatsu - Plugs into Car Harness	163
70-1677-1	General Motors	General Motors - Plugs into Car Harness	151
70-1720	Honda	Honda/Acura 8 - Plugs into Car Harness	155
70-1720T	Honda	Honda Civic - Plugs into Car Harness and OEM Radio	156
70-1721	Honda	Honda/Acura - Plugs into Car Harness	156
70-1722	Honda	Honda Civic (excluding DX model)- Plugs into Car Harness	156



PRODUCT LOCATOR

PART NUMBER	MAKE	DESCRIPTION	PAGE
TURBO WIRES			
70-1724	Honda	Accord - Amp Integration Harness	156
70-1725	Acura	Acura RSX- Amp Integration Harness	156
70-1726	Honda	Honda Element- Amp Bypass Harness	156
70-1727	Honda	Honda Civic- Amp Bypass Harness	156
70-1729	Honda	Honda - Plugs into Car Harness	156
70-1730	Honda	Honda with Premium Sound - Plugs into Car Harness	156
70-1731	Honda	Honda Civic	157
70-1736	Hyundai	Hyundai - Plugs into Car Harness	157
70-1743	Mitsubishi	Chrysler/Plymouth/Dodge/Mitsubishi/Imports - Plugs into Car Harness	145
70-1761	Toyota	Toyota/Scion - Plugs into Car Harness	163
70-1763	Nissan	Nissan - Plugs into Car Harness	161
70-1764	Nissan	Nissan/Infiniti Premium Sound - Plugs into Car Harness	161
70-1768	Ford	Ford/Lincoln/Mercury - Amp Integration Harness	147
70-1770	Ford	Ford/Lincoln/Mercury/Mazda - Plugs into Car Harness	147
70-1771	Ford	Ford/Lincoln/Mercury/Mazda - Plugs into Car Hrness	147
70-1772	Ford	Ford/Lincoln/Mercury - Plugs into Car Harness	147
70-1776	Ford	FORD Expedition / Lincoln Navigator - Plugs in to Car Harness at Radio Location	147
70-1777	Ford	Ford Focus / Mercury Cougar / Plugs into Car Harness at Radio Location	147
70-1780	Subaru	Subaru Legacy/Justy - Plugs into Car Harness	162
70-1781	Mazda	Mazda Ford Festiva / Mercury Tracer - Plugs into Car Harness	159
70-1782	Geo	Geo/ Chevrolet Metro/Chevrolet Spectrum	151
70-1782	Geo	Honda Passport /Isuzu - Plugs into Car Harness	151
70-1783	Smart	Smart ForTwo - Plugs into Car Harness	166
70-1784	VW	Volkswagen - Plugs into Car Harness	166
70-1785	Audi	Volkswagen - Amp Integration Harness	166
70-1786	Land Rover/Mercedes	Land Rover/Mercedes- Amp Integration Harness	163
70-1787	Audi	Audi/VW - Amp Integration Harness	166
70-1787	VW	Volkswagen - Amp Integration Harness	166
70-1817	Chrysler	Chrysler/Plymouth/Dodge/Jeep - Plugs into Car Harness	145
70-1817	Jeep	Chrysler/Plymouth/Dodge/Jeep - Plugs into Car Harness	145
70-1818	Chrysler	Chrysler/Plymouth/Dodge/Jeep - Amp Integration Harness	145
70-1818	Jeep	Chrysler/Plymouth/Dodge/Jeep - Amp Integration Harness	145
70-1855	General Motors	Buick Regal/Chevrolet Full Size Truck /Pontiac Grand Prix	151
70-1855	General Motors	Sunbird - Tuner Bypass Harness	151
70-1856	General Motors	Cadillac Allante/ DeVille/Eldorado Seville / Fleetwood	152
70-1856	General Motors	Fleetwood/ Chevrolet Corvette -Tuner Bypass Harness	152
70-1857	General Motors	Cadillac Allante/ DeVille /Eldorado Seville/ Fleetwood	152
70-1857	General Motors	Chevrolet Corvette - Tuner Bypass Harness and Bose Amplifier Integration Harness	152
70-1858	General Motors	General Motors - Plugs into Car Harness	152
70-1858-1	General Motors	General Motors - Plugs into Car Harness	152
70-1859	General Motors	General Motors Full-Sized Trucks With Factory - Amplified Systems	152
70-2001	General Motors	General Motors - Plugs into Car Harness	152
70-2002	General Motors	Saturn - Plugs into Car Harness	155
70-2003	General Motors	GM/ KIA Sorrento EX / Toyota Matrix / Hyundai Santa Fe w Monsoon	153
70-2003T	General Motors	Class 2 T-Harness	153
70-2005	General Motors	General Motors - On Star System	153
70-2021	General Motors	Impala/Monte Carlo - Amp Bypass Jumper	153
70-2054	General Motors	General Motors Multiple Applications - Amp Bypass Harness	153
70-2057	General Motors	General Motors MOST - (21 pin) Plugs into output of OEM amplifier harness	153
70-2102	General Motors	Saturn - Plugs into Car Harness	155
70-2103	General Motors	Chevrolet Malibu/Pontiac G6 - Plugs into Car Harness	153
70-2103T	Chevrolet	Chevrolet Aveo / Pontiac GT	154
70-2104	General Motors	General Motors - Plugs into Car Harness	154
70-2105	General Motors	Chevrolet Impala/Monte Carlo/Chevrolet Suburban/Taho/GMC Yukon - Wire Harness	154
71-2108	General Motors	GM Full Size Trucks and SUVs	154
70-2202	General Motors	Saturn Ion and Vue - Wire Harness	155
70-5510	Ford	Ford - Amp Integration Harness	148
70-5511	Ford	Ford Premium Sound System- Amp Integrator System	148
70-5512	Ford	Ford Premium Sound SystemAmp Integrator - Plugs into Pre-Amp Harness	148



PRODUCT LOCATOR

PART NUMBER	MAKE	DESCRIPTION	PAGE
TURBO WIRES			
70-5513	Ford	Ford Premium Sound System- Amp Bypass Plug	148
70-5514	Ford	Ford Premium Sound System Amp Eliminator - Plugs into Car Harness	148
70-5515	Ford	Ford Non-Amp to Amp Bypass- OEM Radio Integration	148
70-5517	Ford	Ford Premium Sound Harness	148
70-5518	Ford	Ford Tremor - Amp Integration Harness	148
70-5519	Ford	Ford Amp Integrator Plug Set	149
70-5520	Ford	Ford/Lincoln/Mercury- Plugs into Car Harness	149
70-5520 AUX	Ford	Ford AUX In-Jack Retention Harness	149
70-5520 AV	Ford	Ford - Factory DVD Retention Harness	149
70-5521	Ford	Ford/Lincoln/Mercury - Amp Integration Harness	149
70-5522	Ford	Ford/Lincoln/Mercury - Sub Plug Only	149
70-5523	Ford	Ford Transit	149
70-5524	Ford	Lincoln (w/out SYNC)	150
70-5600	Ford	Ford Premium Sound System- Plugs into Car Harness	150
70-5601	Ford	Ford/Lincoln/Mercury - For installation of aftermarket Head Unit	150
70-5602	Ford	Ford - Amp Bypass Harness	150
70-5603	Ford	Ford - Amp Integration Harness	150
70-5605	Ford	Contour/Mustang/Ranger/Expedition/Lincoln/Navigator - Amp Bypass Harness	150
70-5701	Ford	Ford/Lincoln/Mercury	150
70-5702	Ford	Ford/Lincoln/Mercury/Mazda - Factory Sub Integration Harness	151
70-5715	Ford	Ford Taurus/Mercury Sable - Aftermarket Radio to Factory Speaker Harness	151
70-5716	Ford	Ford Taurus/Mercury Sable -	151
70-5720	Ford	Ford Escort ZX2	151
70-6502	Chrysler	Chrysler - Plugs into Car Harness	145
70-6503	Chrysler	Chrysler - Amp Integration Harness	145
70-6504	Chrysler	300/Durango/Magnum - Amp Bypass Harness	145
70-6506	Chrysler	Chrysler Pacifica - Amp Bypass Harness	146
70-6507	Chrysler	Jeep Grand Cherokee - Amp Bypass Harness	146
70-6510	Chrysler	Ram w/ Hands-Free Amp Bypass Harness	146
70-6512	Chrysler	Dodge Ram - Amp Bypass Harness	146
70-6522	Chrysler	Chrysler/Plymouth/Dodge/Jeep - Plugs into Car Harness	146
70-7001	Mitsubishi	Mitsubishi Dodge Stealth - Plugs into Car Harness	160
70-7002	Mitsubishi	Mitsubishi 3000GT /Diamante / Eclipse/Galant	160
70-7003	Mitsubishi	Dodge/Mitsubishi	160
70-7004	Mitsubishi	MITSUBISHI 4 Speaker with Amp Int	160
70-7005	Mitsubishi	Mitsubishi - Plugs into Car Harness	160
70-7300	Hyundai	Hyundai - Plugs into Car Harness	157
70-7301	Hyundai	Hyundai - Plugs into Car Harness	157
70-7302	Hyundai	Hyundai Santa Fe/Kia Sorrento - Plugs into Car Harness	158
70-7303	Hyundai	Hyundai/KIA with Infinity Sound - Plugs into Car Harness	158
70-7304	Hyundai	Hyundai/KIA Harness	158
70-7305	Hyundai	Hyundai/KIA Amp Bypass for dimension sound systems	158
70-7306	Hyundai/Kia	Hyundai/Kia	158
70-7550	Nissan	Nissan - Plugs into Car Harness	161
70-7551	Nissan	Nissan/Infiniti Premium Sound - Plugs into Car Harness	161
70-7552	Nissan	Nissan /Suburu	161
70-7553	Nissan	Nissan/Suburu	161
70-7554	Nissan	Nissan Bose	161
70-7712	Honda	Honda Passport / Isuzu - Plugs into Car Harness	157
70-7713	Isuzu	Isuzu Rodeo with Factory Amp RCA	159
70-7863	Honda	Honda Element (EX and SC Models)	157
70-7901	Mazda	Mazda - Plugs into Car Harness	159
70-7903	Mazda	Mazda - Plugs into Car Harness	159
70-7903T	Mazda	Mazda CX-7/CX-9 AND RX8 Service Harness	159
70-7991	Suzuki	Suzuki Swift/Sidekick/GEO/Imports - Plugs into Car Harness	162
70-7992	Suzuki	Suzuki - Plugs into Car Harness	162
70-8112	Toyota	Toyota/Lexus - Premium Amp Integration Harness	163
70-8113	Toyota	Toyota/Lexus - Amp Integration Harness	164
70-8116	Toyota	Toyota - Amp Bypass Harness	164

PRODUCT LOCATOR

PART NUMBER	MAKE	DESCRIPTION	PAGE
TURBO WIRES			
70-8117	Toyota	Toyota - Amp Bypass Harness	164
70-8121	Toyota	Toyota Tundra Amp Bypass Harness	164
70-8215	Toyota	Toyota Avalon - Climate Control Retention	164
70-8215AMP	Toyota	Toyota Avalon Radio Relocation Harness	164
70-8405	Daewoo	Daewoo - Plugs into OEM Radio	154
70-8590	BMW	BMW - Plugs into Car Harness	165
70-8591	BMW	BMW 3 Series/7 Series M Coupe/ M3 Coupe/ Z3	165
70-8900	Subaru	Subaru Loyale / DL & GL - Plugs into Car Harness	162
70-8901	Subaru	Subaru - Plugs into Car Harness	162
70-8902	Subaru	Subaru With Premium Sound	162
70-9003	VW	Volkswagen Radio Harness Adapter	165
70-9220	Volvo	Volvo - Plugs into Car Harness	165
70-9221	Volvo	Volvo S60/S80 V70/XC/Crosscountry - Plugs into Car Harness	165
70-9400	Land Rover	Land Rover Discovery Harness - Amp Integration Harness	163
70-9401	Land Rover/Mercedes	Land Rover Discovery /Mercedes Non-Amp - Plugs into Car Harness	163
70-9500	Land Rover/Jaguar	Land Rover /Jaguar	163
70-9800	Harley-Davidson	Harley Davidson Touring Models	155
71-1002	Jeep	Jeep/Eagle - Plugs into OEM Radio	146
71-1003	Kia	KIA - Plugs into OEM Radio	159
71-1004	Hyundai	Hyundai/KIA - Plugs into OEM Radio	157
71-1398	Toyota	Toyota / Daihatsu - Plugs into OEM Radio	163
71-1677-1	General Motors	General Motors - Plugs into OEM Radio	151
71-1720	Honda	Honda/Acura - Plugs into OEM Radio	155
71-1721	Honda	Honda/Acura- Plugs into OEM Radio	156
71-1722	Honda	Honda Civic (excluding DX model) - Plugs into OEM Radio	156
71-1729	Honda	Honda Harness	156
71-1731	Honda	Honda Civic	157
71-1736	Hyundai	Hyundai - Plugs into Original Equipment Radio	157
71-1743	Mitsubishi	Chrysler/Plymouth/Dodge/Mitsubishi/Imports - Plugs into OEM Radio	145
71-1761	Toyota	Toyota/Scion - Plugs into OEM Radio	163
71-1763	Nissan	Nissan - Plugs into OEM Radio	161
71-1770	Ford	Ford/Lincoln/Mercury/Mazda - Plugs into OEM Radio	147
71-1771	Ford	Ford/Lincoln/Mercury/Mazda - Plugs into OEM Radio	147
71-1772	Ford	Ford/Lincoln/Mercury - Plugs into OEM Radio	147
71-1777	Ford	Ford Focus / Mercury Cougar - Plugs into OEM Radio	148
71-1781	Mazda	Mazda / Ford Festiva/Mercury Tracer - Plugs into OEM Radio	159
71-1782	Geo	Geo/Chevrolet Metro/Chevrolet Spectrum	151
71-1782	Geo	Honda Passport / Isuzu 5 - Plugs into OEM Radio	151
71-1784	VW	Volkswagen - Plugs into Original Equipment Radio	166
71-1817	Chrysler	Chrysler/Plymouth/Dodge/Jeep - Plugs into OEM Radio	145
71-1817	Jeep	Chrysler/Plymouth/Dodge/Jeep - Plugs into OEM Radio	145
71-1858	General Motors	General Motors - Plugs into OEM Radio	152
71-1858-1	General Motors	General Motors - Plugs into Car Harness	152
71-2001	General Motors	General Motors - Plugs into OEM Radio	152
71-2002	General Motors	Saturn - Plugs into OEM Radio	155
71-2003-1	General Motors	General Motors - Plugs into Car Harness	153
71-2102	General Motors	Saturn - Plugs into OEM Radio	155
71-2103-1	General Motors	General Motors	153
71-2104	General Motors	General Motors - Plugs into OEM Radio	154
71-2105	General Motors	General Motors - Plugs into Car Harness	154
71-2106	General Motors	General Motors	154
71-2107	General Motors	General Motors Full Size Trucks And Suv's	154
71-2108	General Motors	General Motors	154
71-2202	General Motors	Saturn Ion and Vue - Replacement Wire Harness	155
71-5520	Ford	Ford/Lincoln/Mercury - Plugs into OEM Radio	149
71-5520-1	Ford	Ford/Lincoln/Mercury - Plugs into OEM Radio	149
71-7552	Nissan	Nissan Maxima/Versa	161
71-5524	Ford	Ford Lincoln	150



PRODUCT LOCATOR

PART NUMBER	MAKE	DESCRIPTION	PAGE
TURBO WIRES			
71-5600	Ford	Ford/Lincoln/ Premium Sound System - Plugs into OEM Radio	150
71-6502	Chrysler	Chrysler - Plugs into OEM Radio	145
71-6522	Chrysler	Chrysler - Plugs into OEM Radio	146
71-6523	Chrysler	Chrysler / Dodge - Plugs into factory radio	146
71-6524	Chrysler	Chrysler / Dodge - Plugs into factory radio	146
71-7001	Mitsubishi	Mitsubishi / Dodge Stealth - Plugs into Oem Radio	160
71-7005	Mitsubishi	Mitsubishi- Plugs into OEM Radio	160
71-7300	Hyundai	Hyundai - Plugs into OEM Radio	157
71-7301	Hyundai	Hyundai - Plugs into OEM Radio	158
71-7302	Hyundai	Hyundai Santa Fe- Plugs into OEM Radio	158
71-7303-1	Hyundai	Hyundai Kia	158
71-7304	Hyundai	Hyundai/KIA Harness	158
71-7306	Hyundai/Kia	Hyundai/Kia OEM Harness	158
71-7550	Nissan	Nissan - Plugs into OEM Radio	161
71-7552	Nissan	Nissan/Infinti	161
71-7712	Honda	Honda Passport/ Isuzu - Plugs into OEM Radio	157
71-7713	Isuzu	Isuzu Rodeo	159
71-7901	Mazda	Mazda - Plugs into OEM Radio	159
71-7903	Mazda	Mazda- Plugs into OEM Radio	159
71-7992	Suzuki	Suzuki - Plugs into OEM Radio	162
71-8112	Toyota	Toyota/Lexus - Plugs into OEM Radio	164
71-8113	Toyota	Toyota	164
71-8590	BMW	BMW - Plugs into OEM Radio	165
71-8901	Subaru	Subaru- Plugs into OEM Radio	162
71-9003	VW	Volkswagen - Plugs into OEM Radio	166
71-9003-1	European	European OEM - Plugs into OEM Radio	166
71-9006	Volkswagen	Volkswagen - Plugs into OEM Radio	166
71-9221	Volvo	Volvo S60/S80 I/ V70/XC/Crosscountry - Plugs into OEM Radio	165
71-9600	Harley Davidson	Harley Davidson	155
71-9700	Harley Davidson	Harley Davidson- Plugs into OEM Radio	155
72-1002	Jeep	Jeep / Eagle Speaker Harness	167
72-4500	General Motors	General Motors Speaker Harness	167
72-4530	General Motors	General Motors / Chrysler Speaker Harness	167
72-4568	General Motors	General Motors Speaker Harness	167
72-5500	Ford	Ford Speaker Harness	167
72-5510	Ford	Ford Speaker Harness	167
72-5512	Ford	Ford Speaker Harness	167
72-5600	Ford	Ford Speaker Harness	168
72-5602	Ford	Ford / Mazda Speaker Harness	168
72-6512	Chrysler	Chrysler Speaker Harness	168
72-6514	Chrysler	Chrysler / Dodge Speaker Harness *-SPEAKER-Position	168
72-7300	Hyundai	Hyundai / Kia Speaker Harness - 2-Position	168
72-7301	Hyundai	Hyundai / Kia Speaker Harness - 4-Position	168
72-7302	Hyundai/Kia	Hyundai/Kia	168
72-7400	Nissan	Nissan Speaker Harness	168
72-7401	Nissan	Nissan Speaker Connections	169
72-7800	Honda	Honda Speaker Harness	169
72-7901	Mazda	Mazda Speaker Harness	169
72-7902	Mazda	Mazda/Chrysler/Dodge/Jeep/Hyundai Speaker Harness	169
72-8104	Toyota	Toyota Speaker Harness	169
72-9002	BMW/Audi/Mercedes	BMW/AUDI/MERCEDES	170
72-9003	Audi	Audi	170
72-9300	Euro	Euro / Mazda / Nissan Speaker Harness	170
72-9301	Euro	Euro / Toyota / Mitsubishi Speaker Harness	170
AL16-0001	Alpine	16 pin	171
AL2X8-0001	Alpine	16 pin	171
CL16-0001	Clarion	16 pin	171
CL2X8-0001	Clarion	16 pin	171
CL2X9-0001	Clarion	18 pin	171

PRODUCT LOCATOR

PART NUMBER	MAKE	DESCRIPTION	PAGE
TURBO WIRES			
EC2X8-0001	Eclipse	16 pin	171
JV16-0001	JVC	16 pin	172
JV2X8-0001	JVC	16 pin	172
KN16-0001	Kenwood	16 pin	172
KN22-0001	Kenwood	16 pin	172
PA01-0001	Panasonic	16 pin	172
PA16-0001	Panasonic	16 pin	172
PR01-0001	Pioneer	16 pin	172
PRO4-0001	Pioneer	16 pin	172
PR16-0001	Pioneer	16 pin	172
PR2000-0001	Pioneer	16 pin	172
PR2X8-0001	Pioneer	16 pin	172
SY16-0001	Sony	16 pin	172
SY18-0001	Sony	18 pin	172
SY2X8-0001	Sony	18 pin	172
INSTALLER WORKS			
81-4300	Speaker Baffles	Universal 5 1/4" or 6 1/2"	173
81-6900	Speaker Baffles	Universal 6" x 9"	173
82-1011	Speaker Adapters	Jeep Wrangler	174
82-1012	Speaker Adapters	Jeep Wrangler	174
82-1013	Speaker Adapters	Jeep Wrangler	174
82-3002	Speaker Adapters	All General Motors Full-Size Pickups and Sport Utilities 95-05 Adapts 5 1/4" or 6 1/2"	174
82-3004	Speaker Adapters	General Motors Trucks	174
82-3005	Speaker Adapters	General Motors Trucks	174
82-3006	Speaker Adapters	General Motors Multi	174
82-3010	Speaker Adapters	Chevrolet Camaro	174
82-3013	Speaker Adapters	Chevrolet Corvette	174
82-3014	Speaker Adapters	Chevrolet Corvette Front Doors	175
82-3015	Speaker Adapters	Chevrolet Corvette C7	175
82-3016	Speaker Adapters	Chevrolet Camaro	175
82-3017	Speaker Adapters	Chevrolet Camaro	175
82-3018	Speaker Adapters	Chevrolet Camaro	175
82-3019	Speaker Adapters	Chevrolet Camaro	175
82-3020	Speaker Adapters	Chevrolet Silverado / GMC Sierra	175
82-3021	Speaker Adapters	General Motors	175
82-3022	Speaker Adapters	General Motors	175
82-3023	Speaker Adapters	General Motors	176
82-3043	Speaker Adapters	Chevrolet S-10/T-10 GMC Sonoma Truck /Blazer/Jimmy / Isuzu Hombre Adapts 5 1/4" or 6 1/2"	176
82-3048	Speaker Adapters	Chevrolet/General MotorsC Full Size Van Adapts 5 1/4" or 6 1/2"	176
82-3300	Speaker Adapters	Chevrolet Cavalier Pontiac Sunfire Adapts 5 1/4" or 6 1/2"	176
82-3307	Speaker Adapters	Chevrolet Equinox /GMC Terrain /Pontiac Torrent /Saturn Vue	176
82-3412	Speaker Adapters	GEO Prism	176
82-4201	Speaker Adapters	Toyota/Chrysler Multiple	176
82-4202	Speaker Adapters	Universal Speaker Adapter	176
82-4203	Speaker Adapters	Universal Speaker Adapter	176
82-4300	Speaker Adapters	Universal 1" Plastic Spacer Rings	177
82-4301	Speaker Adapters	Universal 1/2" Spacer Rings for installation of 6" to 6.75"	177
82-4400	Speaker Adapters	Universal 1/2" Plastic Spacer Rings	177
82-4401	Speaker Adapters	Universal 1" Spacer for installation of 6" to 6.75"	177
82-4600	Speaker Adapters	Universal 6.5" Speaker Adapters	177
82-4601	Speaker Adapters	Universal 4"X 6" Speaker Adapters	177
82-4602	Speaker Adapters	Universal 4"X 6" Speaker Adapter Plate	177
82-5600	Speaker Adapters	Ford/Mercury/Mazda Fits 5 1/4" or 6 1/2" Hole to a Ford 6"x8" Opening	177
82-5601	Speaker Adapters	Universal 5 1/4" Speaker and 3/4" to 2" Tweeter to 5"x7" Hole	178
82-5602	Speaker Adapters	Ford Explorer for installation of 6"x9" Aftermarket Speakers	178
82-5603	Speaker Adapters	Ford Explorer for installation of 6" to 6.75" Aftermarket speakers	178
82-5604	Speaker Adapters	Ford Transit Connect Front Doors	178
82-5605	Speaker Adapters	Ford F-150 Rear Doors	178
82-5606	Speaker Adapters	Ford F-150 Front Doors 6"x9"	178
82-5607	Speaker Adapters	Ford F-150 Front Doors 6" to 6-3/4"	178
82-5608	Speaker Adapters	Ford Transit	178
82-6544	Speaker Adapters	Fiat 500	178
82-6600	Speaker Adapters	Chrysler Multi-App	179
82-6601	Speaker Adapters	Chrysler Multi-App	179
82-6602	Speaker Adapters	Dodge Dakota/Durango	179
82-6603	Speaker Adapters	RAM Promaster City	179



PRODUCT LOCATOR

PART NUMBER	MAKE	DESCRIPTION	PAGE
INSTALLER WORKS			
82-6900	Speaker Adapters	Universal 6"x9" Plastic Spacers	179
82-6901	Speaker Adapters	Universal 5 1/4" or 6 1/2" Speaker and 3/4" to 2" Tweeter to 6"x9" Hole	179
82-6902	Speaker Adapters	Universal 1/2" X 6"x9" Stackable Plastic Spacers	179
82-7000	Speaker Adapters	Mitsubishi Lancer/Lancer Sport/Mirage/Outlander	179
82-7300	Speaker Adapters	Hyundai/ Kia Front and Rear Multi	179
82-7301	Speaker Adapters	Hyundai Genesis Coupe	180
82-7302	Speaker Adapters	Hyundai/Kia Multi Front and Rear	180
82-7303	Speaker Adapters	Hyundai/Kia Multi	180
82-7400	Speaker Adapters	Nissan Infiniti Multi	180
82-7401	Speaker Adapters	Infiniti G37	180
82-7402	Speaker Adapters	Nissan Titan	180
82-7500	Speaker Adapters	Mazda/Ford/Nissan Adapts 5 1/4" or 6 1/2" to Oversized OEM 6 1/2"	180
82-7501	Speaker Adapters	Mazda Multi-Application front door adapter	180
82-7803	Speaker Adapters	Honda Accord/Civic/VW Jetta Adapts 5 1/4" or 6 1/2"	180
82-7805	Speaker Adapters	Honda Civic for installation of 6" to 6.75" Aftermarket Speakers	181
82-8139	Speaker Adapters	Toyota	181
82-8140	Speaker Adapters	Toyota	181
82-8146	Speaker Adapters	Toyota Multi for installation of 6" X 9" Aftermarket Speakers	181
82-8147	Speaker Adapters	Toyota Multi for installation of 6" to 6.75" Aftermarket Speakers	181
82-8148	Speaker Adapters	Toyota Toyota / Lexus / Scion for installation of 6" to 6.75" Aftermarket Speakers	181
82-8149	Speaker Adapters	Toyota Camry for installation of 6x9" Aftermarket Speakers	181
82-8150	Speaker Adapters	Toyota Camry for installation of 6" to 6.75" Aftermarket Speakers	181
82-8151	Speaker Adapters	Lexus RX300 for installation of 6" to 6.75" Speakers in the Front Doors	181
82-8152	Speaker Adapters	Toyota Multi for installation of 6" X 9" Aftermarket Speakers	182
82-8153	Speaker Adapters	Toyota Multi for installation of 6" to 6.75" Aftermarket Speakers	182
82-8154	Speaker Adapters	Toyota Multi for installation of 6" X 9" Aftermarket Speakers	182
82-8700	Speaker Adapters	Toyota Sequoia Mounting Adapter for installation of 6" to 6.75" Aftermarket Speakers	182
82-8701	Speaker Adapters	Mercedes-Benz Mounting Adapter for installation of 6" to 6.75" Aftermarket Speakers	182
82-8702	Speaker Adapters	Mercedes-Benz Mounting Adapter for installation of 6" to 6.75" Aftermarket Speakers	182
82-8703	Speaker Adapters	Mercedes-Benz Mounting Adapter for installation of 5.25" Aftermarket Speakers in Rear Doors	182
82-8704	Speaker Adapters	Mercedes-Benz Mounting Adapter for installation of 6.5" to 6.75" Aftermarket Speakers in Rear Deck	182
82-8900	Speaker Adapters	Subaru Legacy	182
82-8901	Speaker Adapters	Subaru WRX	183
82-9101	Speaker Adapters	Audi A3/A4	183
82-9101	Speaker Adapters	Audi A3 & A4 Mounting Adapter for installation of 6" to 6.75" Aftermarket Speakers	183
82-9102	Speaker Adapters	Audi A3 & A4 Mounting Adapter for installation of 6" to 6.75" Aftermarket Speakers in Rear Doors	183
82-9200	Speaker Adapters	Volvo Multi Mounting Adapter for installation of 6" to 6.75" Aftermarket Speakers	183
82-9302	Speaker Adapters	BMW	183
82-9303	Speaker Adapters	BMW 3-Series	183
82-9600	Speaker Adapters	Harley Davidson Touring Models for installation of 6" to 6.5" Aftermarket Speakers	183
82-9601	Speaker Adapters	Harley Davidson Touring Models for installation of 6.5" to 6.75" Aftermarket Speakers	183
82-CH1	Combo Speaker Kit	Chrysler	184
82-CH2	Combo Speaker Kit	Chrysler	184
82-FD1	Combo Speaker Kit	Ford	184
82-GM1	Combo Speaker Kit	General Motors	184
82-GM2	Combo Speaker Kit	General Motors	184
82-GM3	Combo Speaker Kit	General Motors	184
82-GM4	Combo Speaker Kit	General Motors	184
82-HD1	Combo Speaker Kit	Honda	184
82-HD2	Combo Speaker Kit	Honda	184
82-JP1	Combo Speaker Kit	Jeep	185
82-SU1	Combo Speaker Kit	Subaru/Toyota	185
82-TY1	Combo Speaker Kit	Toyota	185
82-VW1	Combo Speaker Kit	Volkswagen	185
85-9008/9010/9012/9015	Grilles	Universal Steel Woofer Grille 8"/10"/12"/15"	185
85-HDW1	Grilles	Woofer Grille Mounting Hardware	185
85-HDW2	Grilles	Woofer Grille Mounting Clips	185
89-00-9025	ABS Plastic	8"x12" Universal ABS	186
89-00-9030	ABS Plastic	12"x12" Universal ABS Blank Gridplate	186
89-00-9031	ABS Plastic	12"x12" Universal ABS Blank Panel	186
89-00-9032	ABS Plastic	17"x21" Universal ABS	186
89-30-0125	Trim Rings	Universal Plastic DIN Trim Ring 1/8"	186
89-30-0250	Trim Rings	Universal Plastic DIN Trim Ring 1/4"	186
89-30-0500	Trim Rings	Universal Plastic DIN Trim Ring 1/2"	186
89-30-0750	Trim Rings	Universal Plastic DIN Trim Ring 3/4"	186
89-30-3900	Trim Rings	Universal DIN Spacer 5/8"	186

PRODUCT LOCATOR

PART NUMBER	MAKE	DESCRIPTION	PAGE
INSTALLER WORKS			
89-30-0900	Trim Rings	Universal Plastic DIN Trim Ring 4 Pack	186
89-40-0500	Trim Rings	ISO DIN Trim Ring 1/2"	186
89-50-0900	Universal	Universal Trim Rings	186
VXT42	Speaker Baffles	Universal 4" Round	173
VXT46	Speaker Baffles	Universal 4" x 6" Oval	173
VXT55	Speaker Baffles	Universal 5" - 5 1/4" Round	173
VXT57	Speaker Baffles	Universal 5" x 7" Oval Baffle	173
VXT60	Speaker Baffles	Universal 6 1/2" Round Large	173
VXT62	Speaker Baffles	Universal 6 1/2" Round Shallow Large	173
VXT65	Speaker Baffles	Universal 6 1/2" Round Small	173
VXT69	Speaker Baffles	Universal 6" x 9" Oval	173
ANTENNAWORKS®			
AMMO-DISPLAY	Ammotenna Display	Ammotenna POP Counter Display	208
ARLNG	Arrow Style Antenna	Mossy Oak®	207
30FB	Ammo Style Antenna	4.25" Billet Aluminum .30 Cal Replica Antenna Mast in Flat Black	205
30GCF	Ammo Style Antenna	4.25" Billet Aluminum .30 Cal Replica Antenna Mast in Gold with Carbon Fiber Wrap	205
30GM	Ammo Style Antenna	4.25" Billet Aluminum .30 Cal Replica Antenna Mast in Gun Metal	205
30KN	Ammo Style Antenna	4.25" Billet Aluminum .30 Cal Replica Antenna Mast in Kryptek® Neptune™	205
40-CR10	Adapter	Chrysler/Dodge/Ford/General Motors 2006 Jeep Antenna Adapter	188
40-CR20	Adapter	Chrysler/Dodge/Ford/General Motors/Jeep Antenna Adapter	188
40-CR30	Adapter Kit	Chrysler/Dodge/Ford/General Motors/Jeep Antenna Adapter	188
40-EU10	Adapter	VW/BMW/European Antenna Adapter	193
40-EU20	Adapter	VW/BMW/European Antenna Adapter	193
40-EU30	Adapter Kit	VW/BMW/European Antenna Adapter	193
40-EU55	Adapter	VW/BMW/European Antenna Adapter	193
40-EU56	Adapter	European dual Fakra	193
40-EU66	Adapter	European dual Fakra	193
40-FD10	Adapter	Ford/Lincoln/Mercury Antenna Adapter	188
40-FD20	Adapter	Ford/Lincoln/Mercury Antenna Adapter	188
40-FD30	Adapter	Ford/Lincoln/Mercury Antenna Adapter	188
40-GM10	Adapter	General Motors Antenna Adapter	188
40-GM12	Adapter	General Motors Antenna Adapter	189
40-GM20	Adapter	General Motors Antenna Adapter	189
40-GM21	Adapter	General Motors Antenna Adapter	189
40-GM30	Adapter	General Motors Antenna Adapter	188
40-GM31	Adapter	General Motors Antenna Adapter	189
40-GPS-JAK	Adapter	Factory NAV Antenna Adapter to Fakra Connector	200
40-GPS-PIO	Adapter	Factory NAV Antenna Adapter to Fakra Connector	200
40-HD10	Adapter	Honda/Acura Antenna Adapter	189
40-HD10L	Adapter	Mazda Antenna Adapter	189
40-HD11	Adapter	Honda/Acura Antenna Adapter	189
40-HD12	Adapter	Honda / Acura Antenna Adapter	190
40-HD13	Adapter	Honda Antenna Adapter	190
40-HD20	Adapter	Honda/Acura Antenna Adapter	189
40-HD21	Adapter	Honda/Acura Antenna Adapter	189
40-HD22	Adapter	Honda / Acura Antenna Adapter	190
40-HD23	Adapter	Honda Antenna Adapter	190
40-HD30	Adapter	Honda/Acura Antenna Adapter	189
40-HD31	Adapter	Honda/Acura Antenna Adapter	189
40-HD32	Adapter	Honda/Acura Antenna Adapter	190
40-HD33	Adapter	Honda/Acura Antenna Adapter	190
40-K110	Adapter	KIA/KIA Amanti Antenna Adapter	190
40-K111	Adapter	KIA/KIA Amanti Antenna Adapter	191
40-K120	Adapter	KIA/KIA Amanti Antenna Adapter	190
40-K121	Adapter	KIA/KIA Amanti Antenna Adapter	191
40-K130	Adapter	KIA/KIA Amanti Antenna Adapter	190
40-K131	Adapter	KIA/KIA Amanti Antenna Adapter	191
40-LX10	Adapter	Lexus Antenna Adapter	191
40-LX11	Adapter	Lexus Antenna Adapter	191
40-LX20	Adapter	Lexus Antenna Adapter	191
40-LX21	Adapter	Lexus Antenna Adapter	191
40-LX30	Adapter	Lexus Antenna Adapter	191
40-LX31	Adapter	Lexus Antenna Adapter	191
40-N110	Adapter	Infiniti/Nissan Antenna Adapter	192
40-N111	Adapter	Infiniti/Nissan Antenna Adapter	192



PRODUCT LOCATOR

PART NUMBER	MAKE	DESCRIPTION	PAGE
ANTENNAWORKS®			
40-N112	Adapter	Infiniti/Nissan Antenna Adapter	192
40-N120	Adapter	Infiniti/Nissan Antenna Adapter	192
40-N121	Adapter	Infiniti/Nissan Antenna Adapter	192
40-N122	Adapter	Infiniti/Nissan Antenna Adapter	192
40-N130	Adapter	Infiniti/Nissan Antenna Adapter	192
40-N131	Adapter	Infiniti/Nissan Antenna Adapter	192
40-N132	Adapter	Infiniti/Nissan Antenna Adapter	192
40-SB10	Adapter	Subaru Antenna Adapter	193
40-SB11	Adapter	Subaru	193
40-SB10-18	Adapter	18" Antenna Adapter Subaru Legacy/Outback W/OE NAV	193
40-SB20	Adapter	Subaru Antenna Adapter	193
40-SB21	Adapter	Subaru Antenna Adapter	193
40-SB30	Adapter	Subaru Antenna Adapter	193
40-SB31	Adapter	Subaru Antenna Adapter	193
40-SIRXM	Adapter	Universal OE Satellite Radio Antenna Adapter	200
40-SIRXM-17	Adapter	Universal OE Satellite Radio Antenna Adapter	200
40-UV40	Adapter	Universal Antenna Connectors	195
40-UV41	Adapter	Universal Antenna Adapter	195
40-UV42	Adapter	Universal Antenna Adapter	195
40-UV43	Adapter	Universal Antenna Adapter	195
40-UV44	Adapter	Universal Antenna Adapter	195
40-UV45	Connector	Universal Antenna Connectors	195
40-VL10	Adapter	Volvo	194
40-VL11	Adapter	Volvo	194
40-VL20	Adapter	Volvo	194
40-VL21	Adapter	Volvo	194
40-VL30	Adapter	Volvo	194
40-VL31	Adapter	Volvo	194
40-VW10	Adapter	Audi/BMW/Mercedes/VW Antenna Adapter	194
40-VW12	Adapter	Audi/BMW/Mercedes/VW Antenna Adapter	195
40-VW20	Adapter	Audi/BMW/Mercedes/Volkswagen	194
40-VW21	Adapter	Audi/BMW/Mercedes/VW Antenna Adapter	195
40-VW30	Adapter	Audi/BMW/Mercedes/VW Antenna Adapter	194
40-VW53	Adapter	Audi/VW Antenna Adapter	195
40-VW54	Adapter	Audi/VW Antenna Adapter	195
44-ANT10	Antenna	48" Flexible Wire Dipole Antenna	202
44-CR190B	Antenna	Dodge Ram Truck Antenna	203
44-CR72	Antenna	Jeep Comanche/Cherokee/Wagoneer Antenna	203
44-CR88	Antenna	Chrysler Multi-Application Antenna	203
44-EC12	Extension	12"/30cm Extension Cable	196
44-EC120	Extension	120"/305cm Extension Cable	196
44-EC12R	Extension	12"/30cm Right Angle Extension Cable	196
44-EC144	Extension	144"/366cm Extension Cable	196
44-EC18	Extension	18"/46cm Extension Cable	196
44-EC204	Extension	204"/518cm Extension Cable	196
44-EC24	Extension	24"/61cm Extension Cable	196
44-EC240	Extension	240"/610cm Extension Cable	196
44-EC36	Extension	36"/91cm Extension Cable	196
44-EC48	Extension	48"/122cm Extension Cable	196
44-EC6R	Extension	6"/15cm Right Angle Extension Cable	196
44-EC72	Extension	72"/182cm Extension Cable	196
44-EC96	Extension	96"/244cm Extension Cable	196
44-FD80	Antenna	Ford Universal Rectangular Base Antenna	203
44-FD810	Antenna	Ford Universal Rectangular Base Antenna	203
44-GM92	Antenna	Chevrolet/General MotorsC Full Size Truck 1500, 2500, 3500 Antenna	204
44-GM92B	Antenna	Chevrolet/General MotorsC Full Size Truck 1500, 2500, 3500 Antenna	204
44-GM935	Antenna	General Motors Multi-Applications Antenna	204
44-GM935B	Antenna	General Motors Multi-Applications Antenna	204
44-GM94B	Antenna	General Motors Trucks and Vans Antenna	204
44-HD98	Antenna	Geo Prizm/Storm/Civic/Toyota Corolla SR5/Isuzu Stylus	204
44-MAUS07R	Antenna	Marine Amplified Glass Mount Antenna White	201
44-PW20	Power Antenna	Fully Automatic 6/BX Power Antenna	187
44-PW22	Power Antenna	Fully Automatic 6/BX Power Antenna	187
44-PW22B	Power Antenna	Fully Automatic 6/BX Power Antenna	187
44-PW530	Power Antenna	Fully Automatic 6/BX Power Antenna	187

PRODUCT LOCATOR

PART NUMBER	MAKE	DESCRIPTION	PAGE
ANTENNAWORKS®			
44-PWEC157	Power Antenna	Power Antenna Extension Cable - Fits Metra power antennas and Harada MX22	187
44-PWR22	Replacement Mast	Replacement Mast for 44-PW12/44-PW12B/44-PW22/44-PW22B	187
44-PWR22B	Replacement Mast	Replacement Mast for 44-PW12/44-PW12B/44-PW22/44-PW22B	187
44-PWR64	Replacement Mast	Replacement Mast for 44-PW530/44-PW64	187
44-RM02	Replacement Mast	Aluminum Replacement Mast	197
44-RM02B	Replacement Mast	Anodized Replacement Mast	197
44-RM1R	Replacement Mast	Universal Black Rubber Replacement Mast	197
44-RM22	Replacement Mast	Universal Replacement Mast	197
44-RM22B	Replacement Mast	Universal Black Replacement Mast	197
44-RMMC1	Replacement Mast	Harley-Davidson Replacement Mast	200
44-RMMC2	Replacement Mast	Indian/Victory Replacement Mast	200
44-RMOE	Replacement Mast	16 Inch Wire Wound Fiberglass Oem Replacement Mast	198
44-RMSR	Replacement Mast	7 Inch Rubber Oem Replacement Mast	198
44-RMWW	Replacement Mast	8 Inch Wire Wound Rubber OEM Replacement Mast	198
44-RMCFR3	Replacement Mast	13 Inch Cf Water Transfer Print-Roof or Fender	198
44-RMCF	Replacement Mast	4 Inch Carbon Fiber Roof Mount Replacement Mast	198
44-SHSH	Replacement Mast	8 Inch Black Steel Replacement Mast	198
44-RMF2	Replacement Mast	Wire Winding Replacement Mast	197
44-SHTB	Replacement Mast	14 Inch Mast General Motors/Ford/Chry/Japn Bl	197
44-SHTS	Replacement Mast	DbI Blstr Repl Mst General Motors/Fd/Chry	197
44-STUB	Replacement Mast	3 Inch Black Rubber Replacement Mast	198
44-SIXM	XM/Sirius	Magnet/Adhesive Mount	200
44-TY205	Antenna	Geo Prizm/Subaru Impreza/Loyale/Toyota Camry/Corolla	204
44-TY205	Antenna	GTS FX16/Paseo/Tercel	204
44-TY23	Antenna	Toyota Truck/4Runner/Camry/Celica Supra Antenna	204
44-UA20	Amplified Antenna	Amplified Hide-Away Antenna	198
44-UA200	Amplified Antenna	Amplified Glass Mount Antenna	199
44-UA205	Amplified Antenna	Amplified Glass Mount Antenna	199
44-UA25	AM/FM Antenna	On-Glass Micro Screen AM/FM Antenna	199
44-UA30	Amplified Antenna	Amplified Roof Mount Antenna	199
44-UA40	Amplified Antenna	Amplified Roof Mount Antenna	199
44-UA42	Amplified Antenna	Amplified Roof Mount Antenna	199
44-UA44	Amplified Antenna	Amplified Roof Mount Antenna	199
44-UA46	Amplified Antenna	Amplified Roof Mount Antenna	199
44-UA60	Amplified Antenna	Antenna Amplifier	199
44-UL09	Key Lock	Universal Retractable Antenna	200
44-UL10	Key Lock	Mazda RX7 Universal Retractable Antenna	200
44-UL105	Antenna	BMW/Mercedes/Jaguar/Peugeot/Porsche Antenna	204
44-UL15	Key Lock	Universal Retractable Antenna	201
44-UM53	Universal Antenna	Universal Mirror Mount Antenna	201
44-UP21	Universal Antenna	Toyota/Universal Pillar Mount Antenna	201
44-UP58	Universal Antenna	Universal Pillar Mount Antenna	201
44-US01R	Universal Antenna	Universal Rubber Antenna	201
44-US03R	Universal Antenna	Universal Rubber Antenna	201
44-US07R	Universal Antenna	Universal Rubber Antenna	201
44-US13	Universal Antenna	Universal Antenna	201
44-US19	Universal Antenna	Universal Antenna	202
44-US30	Universal Antenna	Universal Antenna	202
44-US401	Universal Antenna	Jeep Antenna	203
44-US502	Universal Antenna	Jeep Wrangler Antenna	203
44-US51B	Universal Antenna	Jeep Wrangler Antenna	203
44-US71	Universal Antenna	Universal Antenna	202
44-UT03R	Universal Antenna	Universal Rubber Antenna	202
44-UT10	Universal Antenna	Universal Antenna	202
44-UT30	Universal Antenna	Universal Antenna	202
44-UT91	Universal Antenna	Universal Narrow Base Antenna	202
50CF	Ammo Style Antenna	5.5" Billet Aluminum .50 Cal Replica Antenna Mast with Carbon Fiber Wrap	206
50CFB	Ammo Style Antenna	5.5" Billet Aluminum .50 Cal Replica Antenna Mast with Black Carbon Fiber Wrap	206
50FB	Ammo Style Antenna	5.5" Billet Aluminum .50 Cal Replica Antenna Mast with Flat Black Wrap	206
50GD	Ammo Style Antenna	5.5" Billet Aluminum .50 Cal Replica Antenna Mast in Gold	207
50GM	Ammo Style Antenna	5.5" Billet Aluminum .50 Cal Replica Antenna Mast with Gun Metal Wrap	207
50HC	Ammo Style Antenna	5.5" Billet Aluminum .50 Cal Replica Antenna Mast with Mossy Oak Break-up Country Wrap	207
50KN	Ammo Style Antenna	5.5" Billet Aluminum .50 Cal Replica Antenna Mast with Kryptek Neptune Wrap	206
50US	Ammo Style Antenna	5.5" Billet Aluminum .50 Cal Replica Antenna Mast with U.S. Flag Wrap	206
50WF	Ammo Style Antenna	5.5" Billet Aluminum .50 Cal Replica Antenna Mast with Wildfire Wrap	207



Learn more about motorcycle auxiliary lights we have.